



US00D454724S

(12) **United States Design Patent**
Hokanson

(10) **Patent No.:** **US D454,724 S**

(45) **Date of Patent:** **** Mar. 26, 2002**

(54) **FURNITURE UNIT**

(75) **Inventor:** **Gary Hokanson, Martinsville, VA (US)**

(73) **Assignee:** **Stanley Furniture Company, Inc.,
Stanleytown, VA (US)**

(**) **Term:** **14 Years**

(21) **Appl. No.:** **29/147,878**

(22) **Filed:** **Sep. 10, 2001**

D178,056 S * 6/1956 Herrmann D6/446
D344,199 S * 2/1994 Stephens D6/446
D416,144 S * 11/1999 Walters, III et al. D6/437
D428,280 S * 7/2000 Walters, III et al. D6/446

* cited by examiner

Primary Examiner—Cathron C. Brooks
(74) *Attorney, Agent, or Firm*—McGuire Woods LLP

Related U.S. Application Data

(62) Division of application No. 29/137,095, filed on Feb. 14, 2001.

(51) **LOC (7) Cl.** **06-04**

(52) **U.S. Cl.** **D6/441; D6/446**

(58) **Field of Search** D6/432-448; 312/114,
312/138.1, 204, 224

(56) **References Cited**

U.S. PATENT DOCUMENTS

D98,367 S * 1/1936 Pumphrey D6/446

(57) **CLAIM**

The ornamental design for a furniture unit, as shown.

DESCRIPTION

FIG. 1 is a perspective view of a furniture unit;
FIG. 2 is a front elevational view of the furniture unit;
FIG. 3 is a rear elevational view of the furniture unit;
FIG. 4 is a top elevational view of the furniture unit;
FIG. 5 is a side elevational view of the furniture unit; and,
FIG. 6 is a side elevational view of the furniture unit.
The broken lines are for illustrative purposes only and form no part of the claimed design.

1 Claim, 6 Drawing Sheets

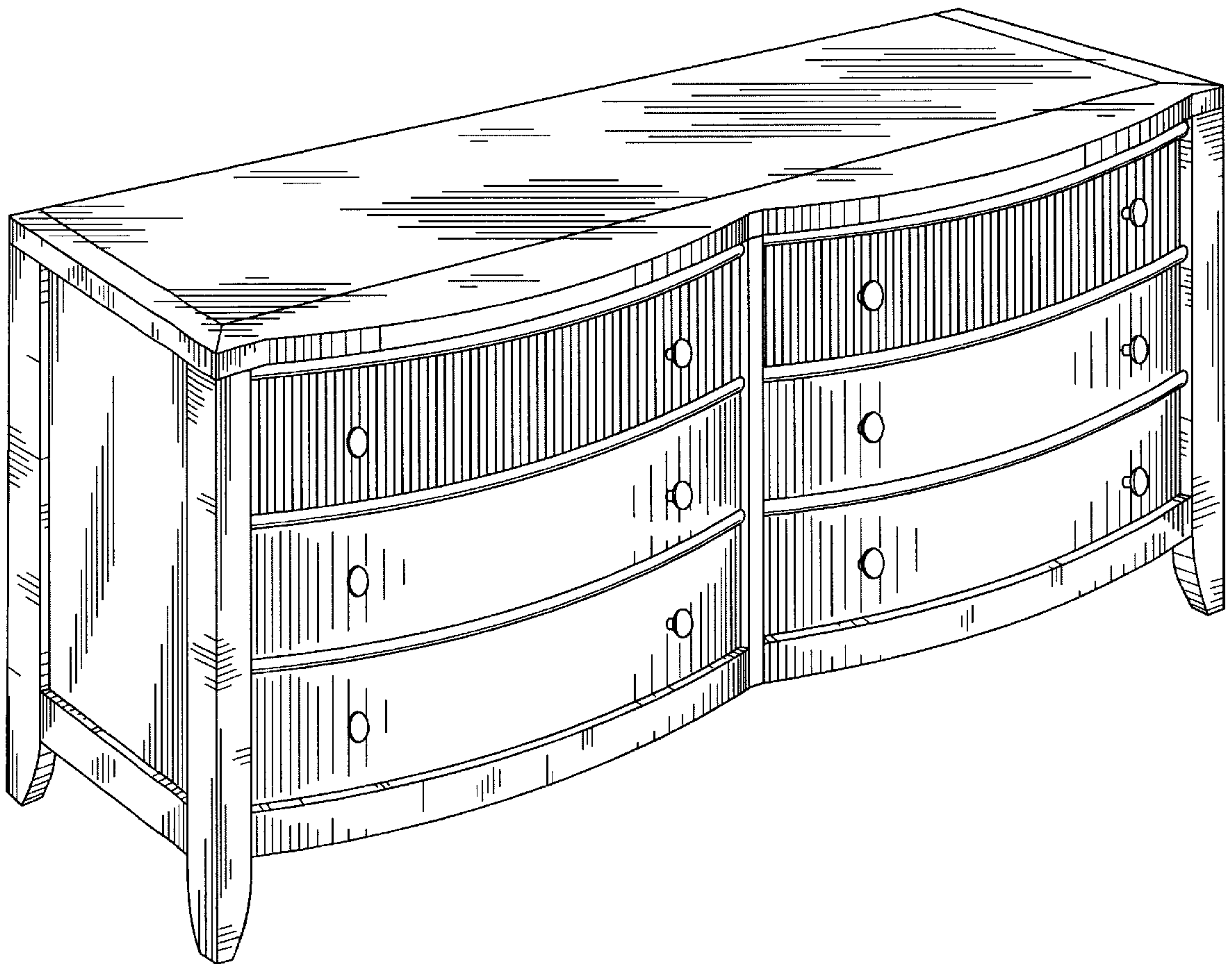

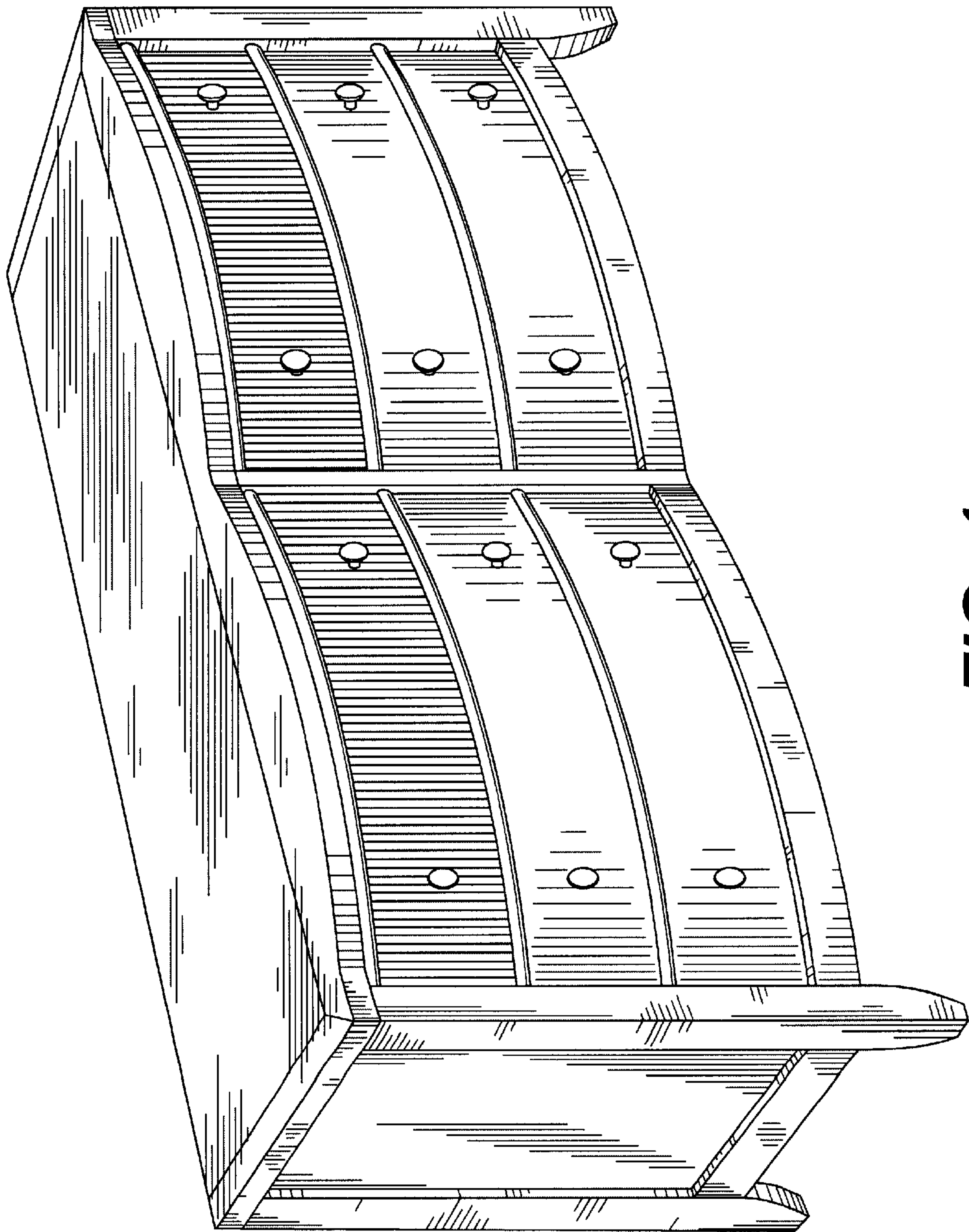

FIG. 1

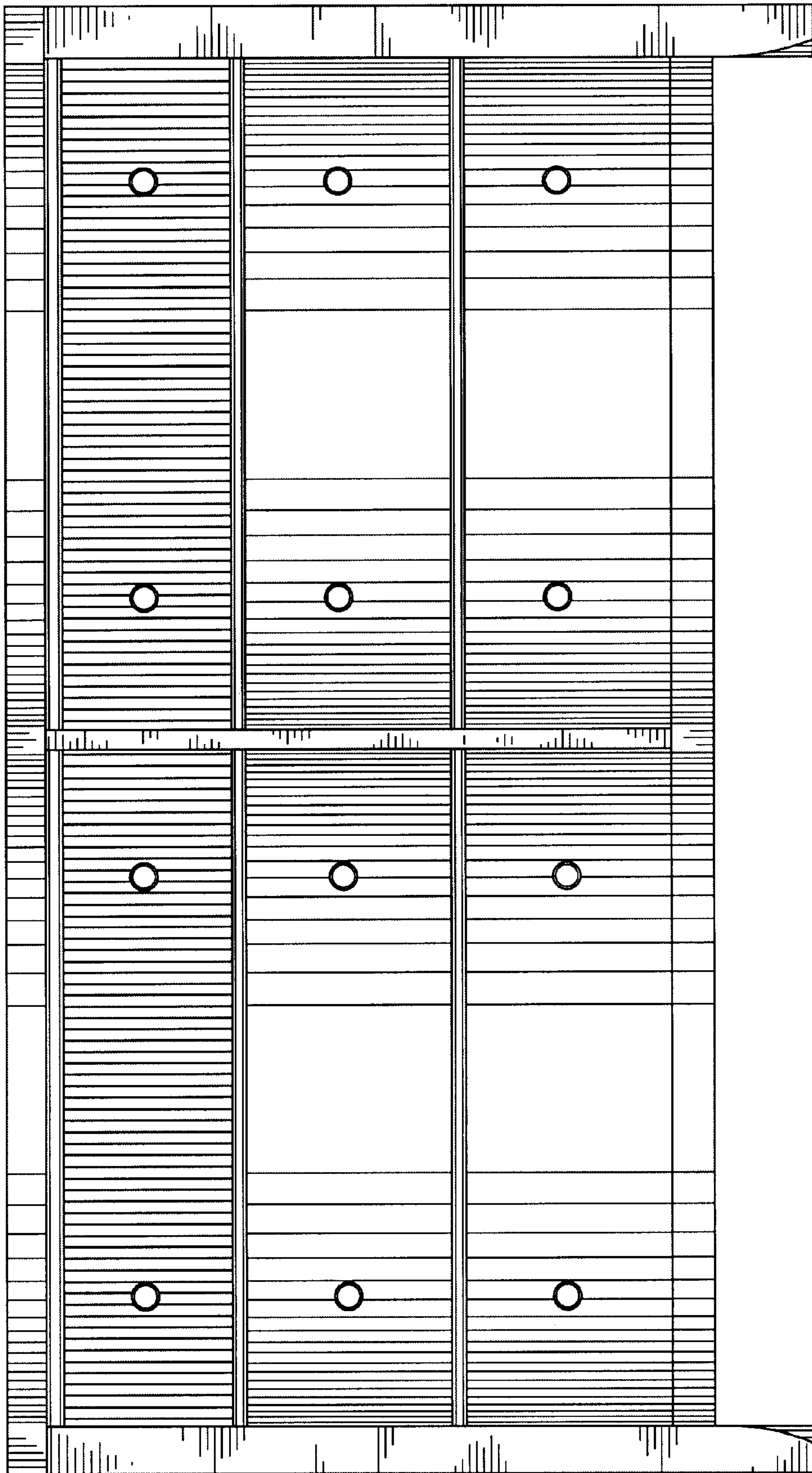

FIG. 2

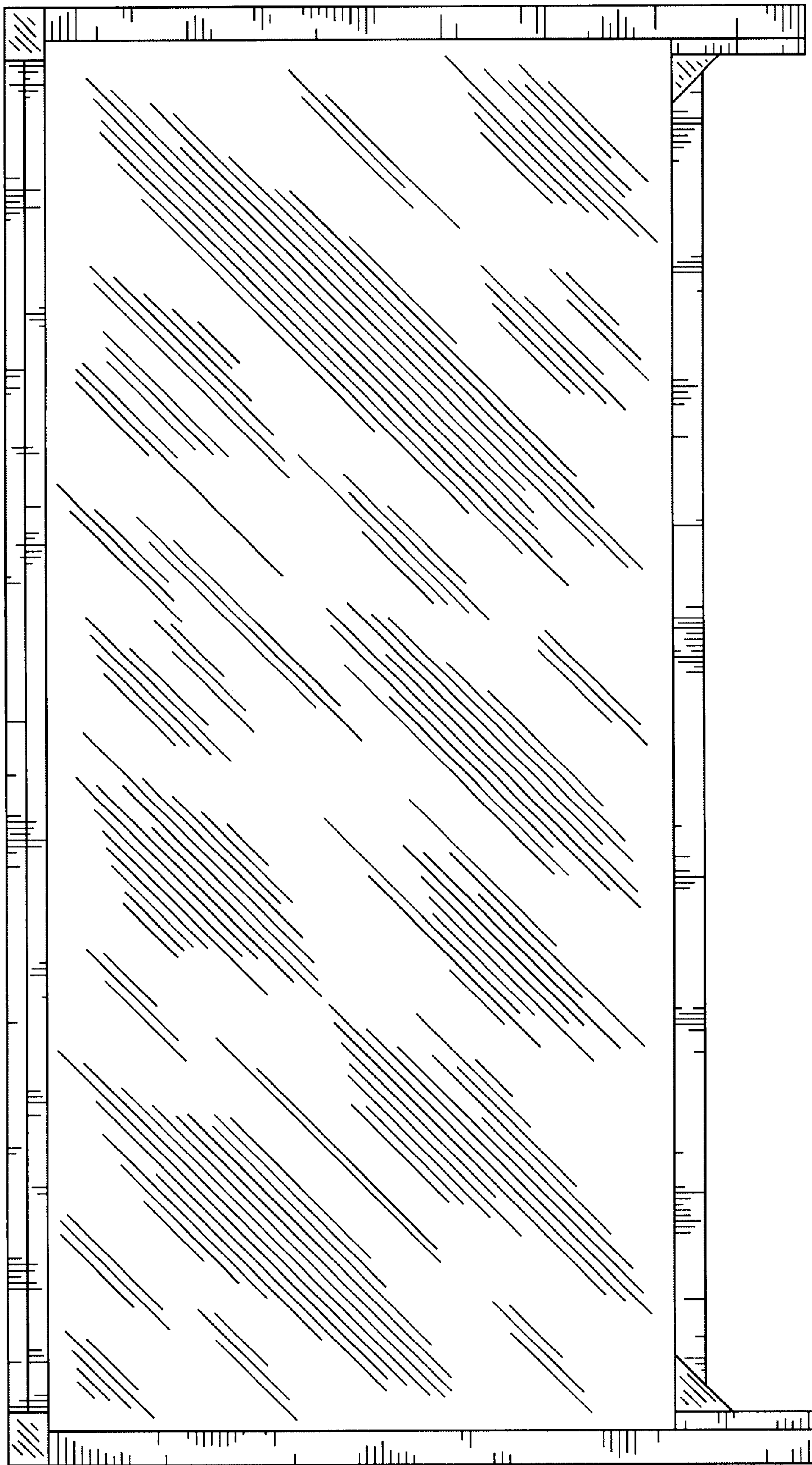

FIG. 3

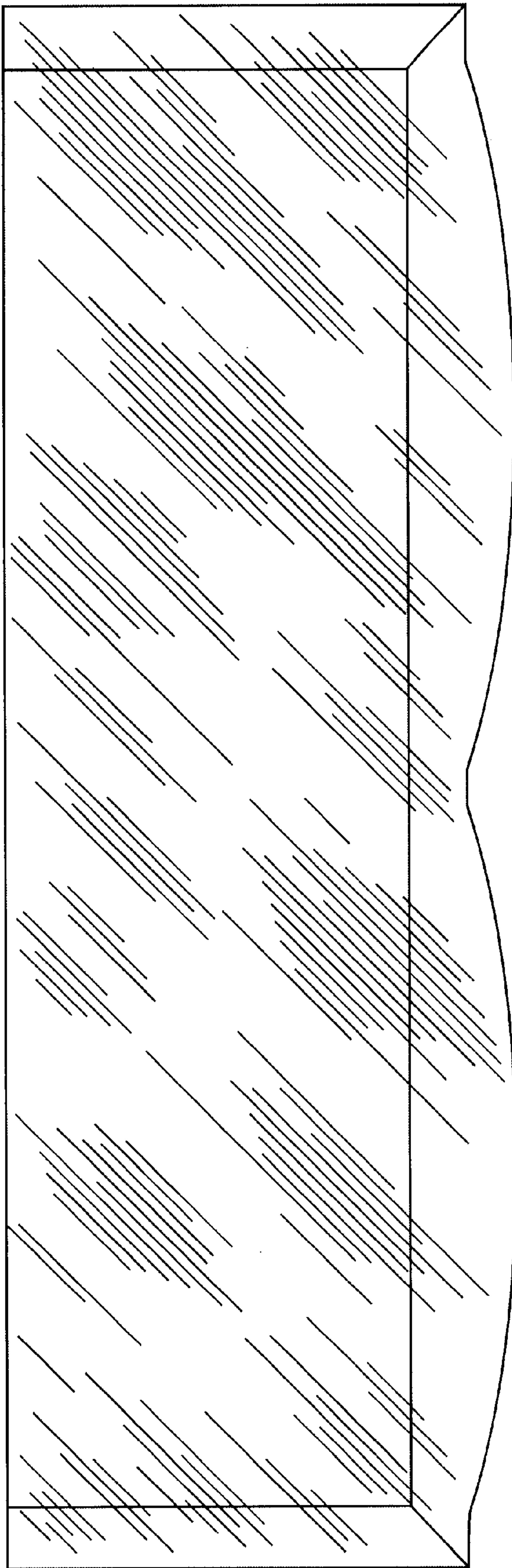

FIG. 4

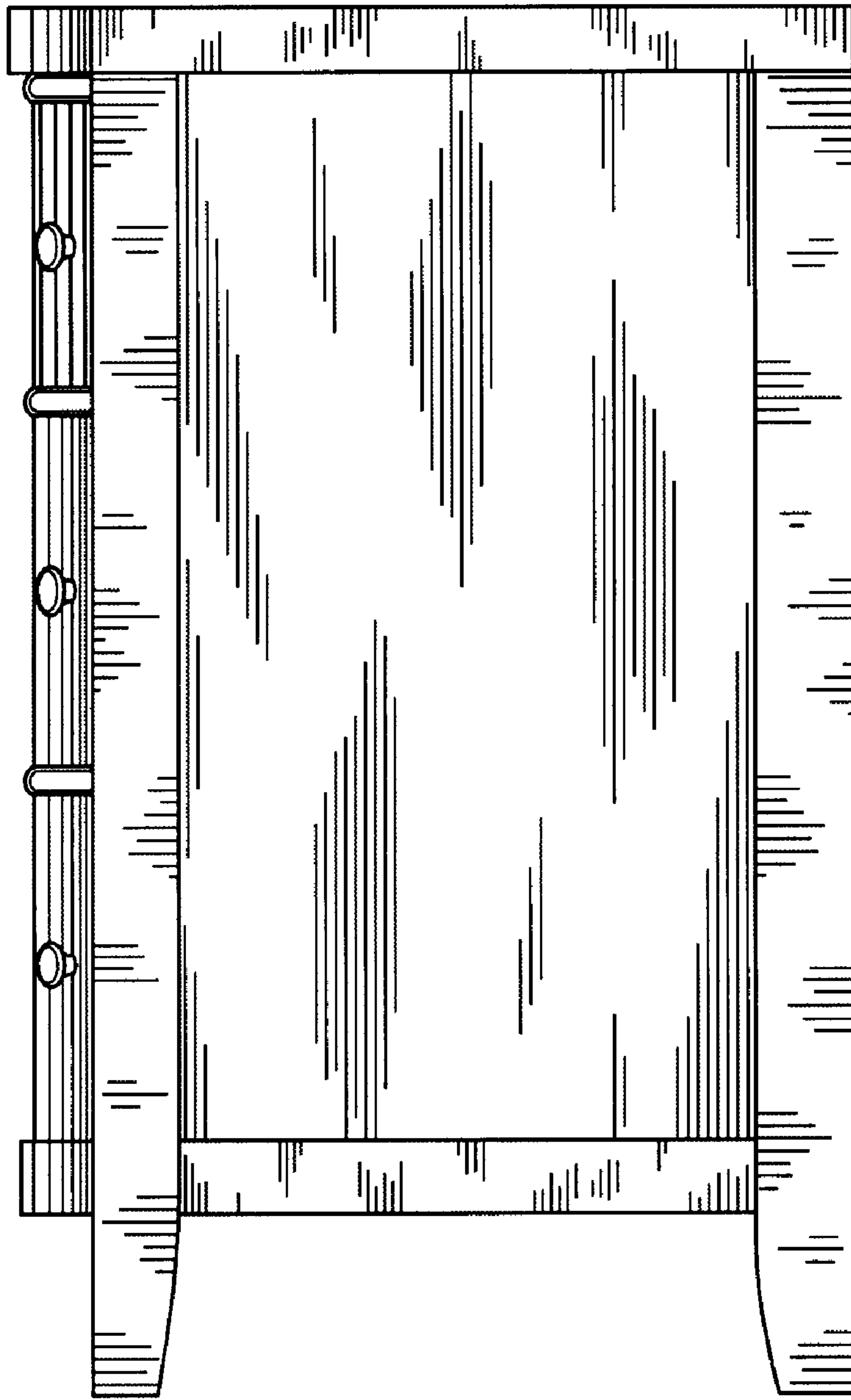

FIG. 5

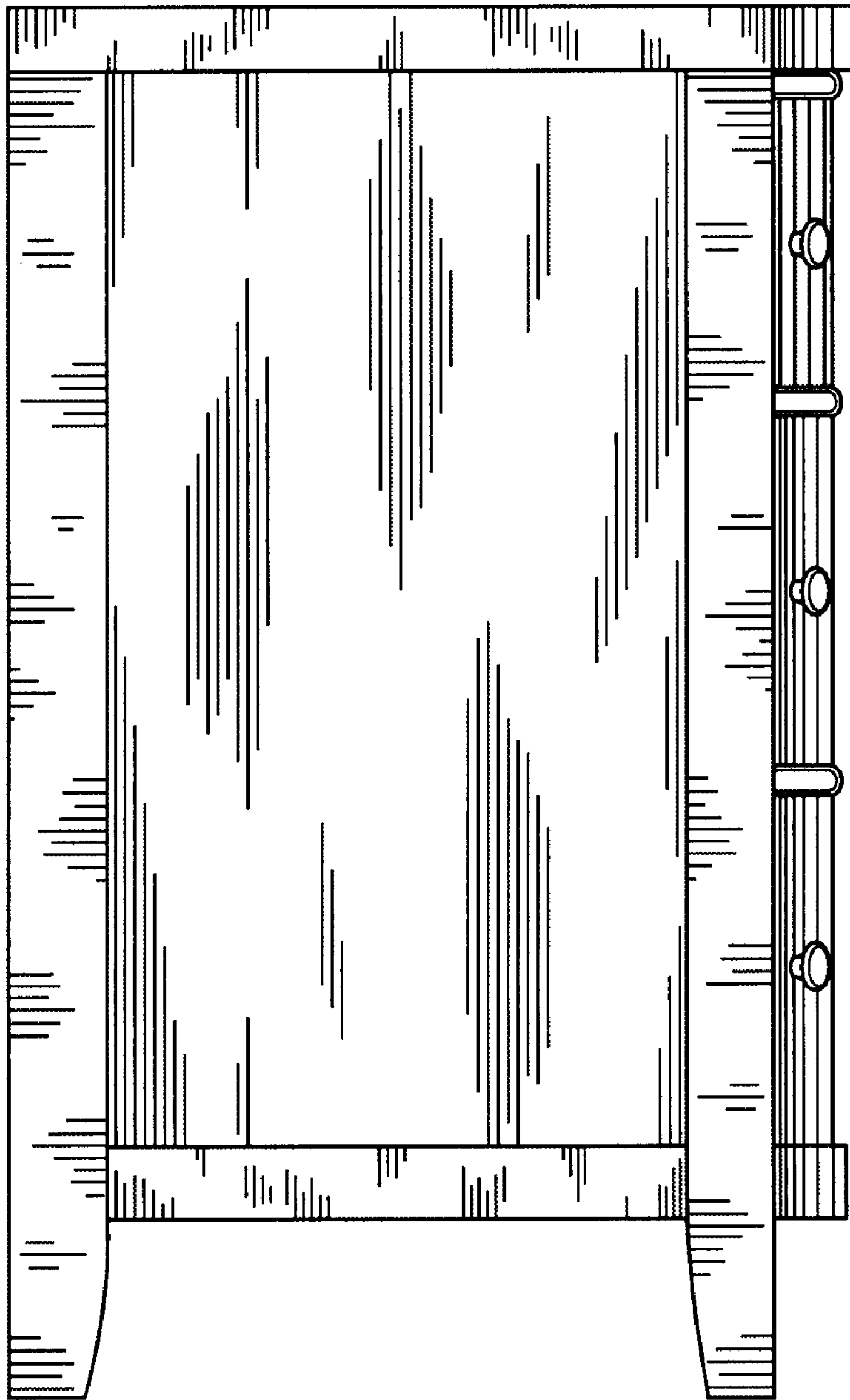

FIG. 6