



US00D454712S

(12) **United States Design Patent**
Tseng

(10) **Patent No.:** **US D454,712 S**

(45) **Date of Patent:** **** Mar. 26, 2002**

(54) **CHAIR**

(75) Inventor: **Chuen-Jong Tseng**, Chiayi Hsien (TW)

(73) Assignee: **Shin Yeh Enterprise Co., Ltd.**, Chiayi Hsien (TW)

(**) Term: **14 Years**

(21) Appl. No.: **29/140,438**

(22) Filed: **Apr. 18, 2001**

(51) **LOC (7) Cl.** **06-01**

(52) **U.S. Cl.** **D6/376; D6/369; D6/370**

(58) **Field of Search** D6/334, 358, 369,
D6/370, 374, 376, 379, 380, 500, 501,
502; 297/446.1, 452.63, 452.64

(56) **References Cited**

U.S. PATENT DOCUMENTS

D371,684 S	*	7/1996	Caldwell	D6/376
D417,345 S	*	12/1999	Bell et al.	D6/376
D422,425 S	*	4/2000	Tseng	D6/376
D426,718 S	*	6/2000	Gaylord et al.	D6/376
D426,975 S	*	6/2000	Gaylord et al.	D6/376
D434,239 S	*	11/2000	Tseng	D6/376
D436,750 S	*	1/2001	Tseng	D6/376
D446,957 S	*	8/2001	Caldwell	D6/376

* cited by examiner

Primary Examiner—Gary D. Watson

(74) *Attorney, Agent, or Firm*—Ladas & Parry

(57) **CLAIM**

The ornamental design for chair, as shown and described.

DESCRIPTION

FIG. 1 is a perspective view of one embodiment of a chair showing my new design;

FIG. 2 is a front elevational view of the chair of FIG. 1;

FIG. 3 is a rear elevational view of the chair of FIG. 1;

FIG. 4 is a left side elevational view of the chair of FIG. 1;

FIG. 5 is a right side elevational view of the chair of FIG. 1;

FIG. 6 is a top plan view of the chair of FIG. 1;

FIG. 7 is a bottom plan view of the chair of FIG. 1;

FIG. 8 is a perspective view of another embodiment of a chair showing my new design;

FIG. 9 is a front elevational view of the chair of FIG. 8;

FIG. 10 is a rear elevational view of the chair of FIG. 8;

FIG. 11 is a left side elevational view of the chair of FIG. 8;

FIG. 12 is a right side elevational view of the chair of FIG. 8;

FIG. 13 is a top plan view of the chair of FIG. 8; and,

FIG. 14 is a bottom plan view of the chair of FIG. 8.

1 Claim, 8 Drawing Sheets

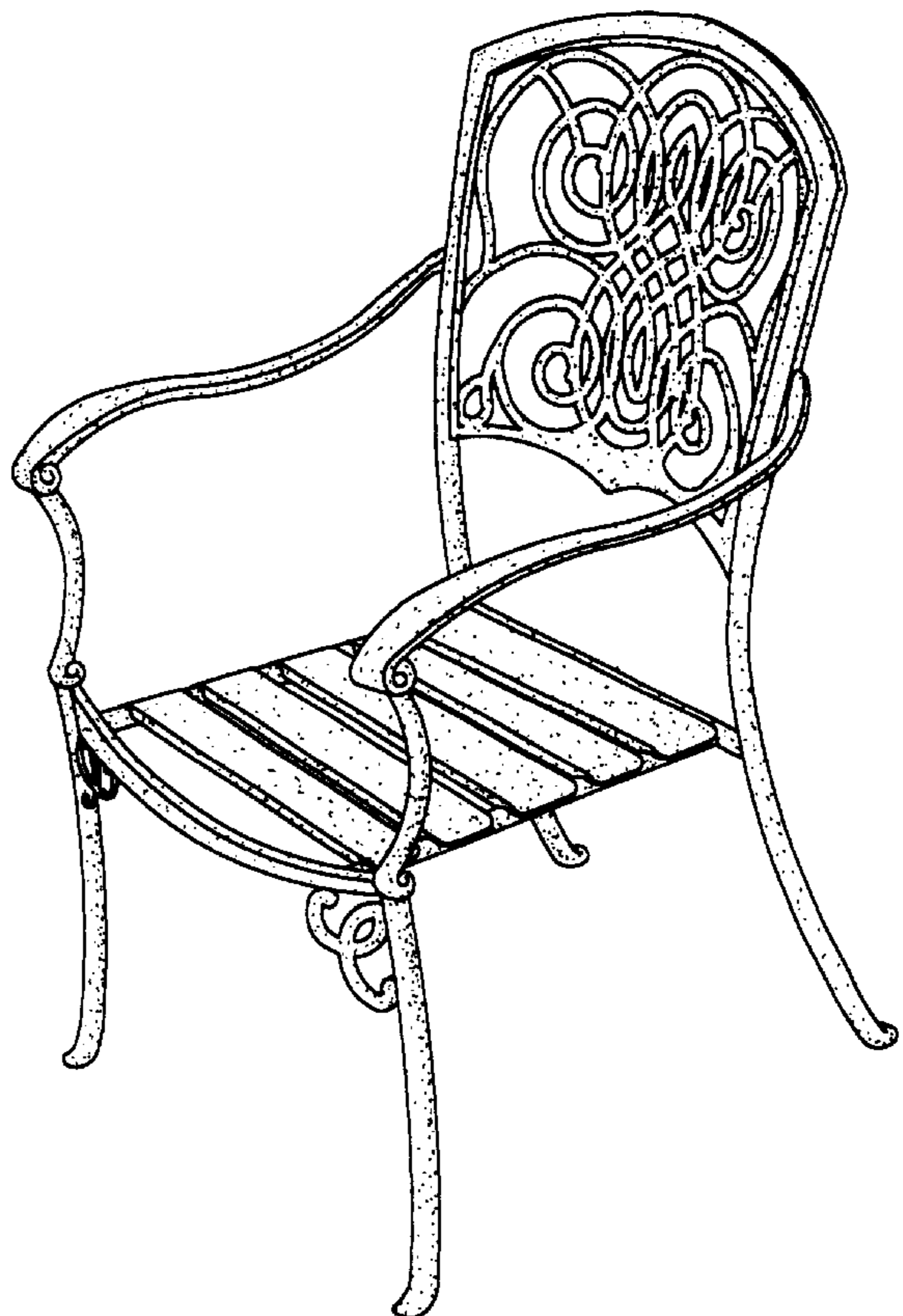
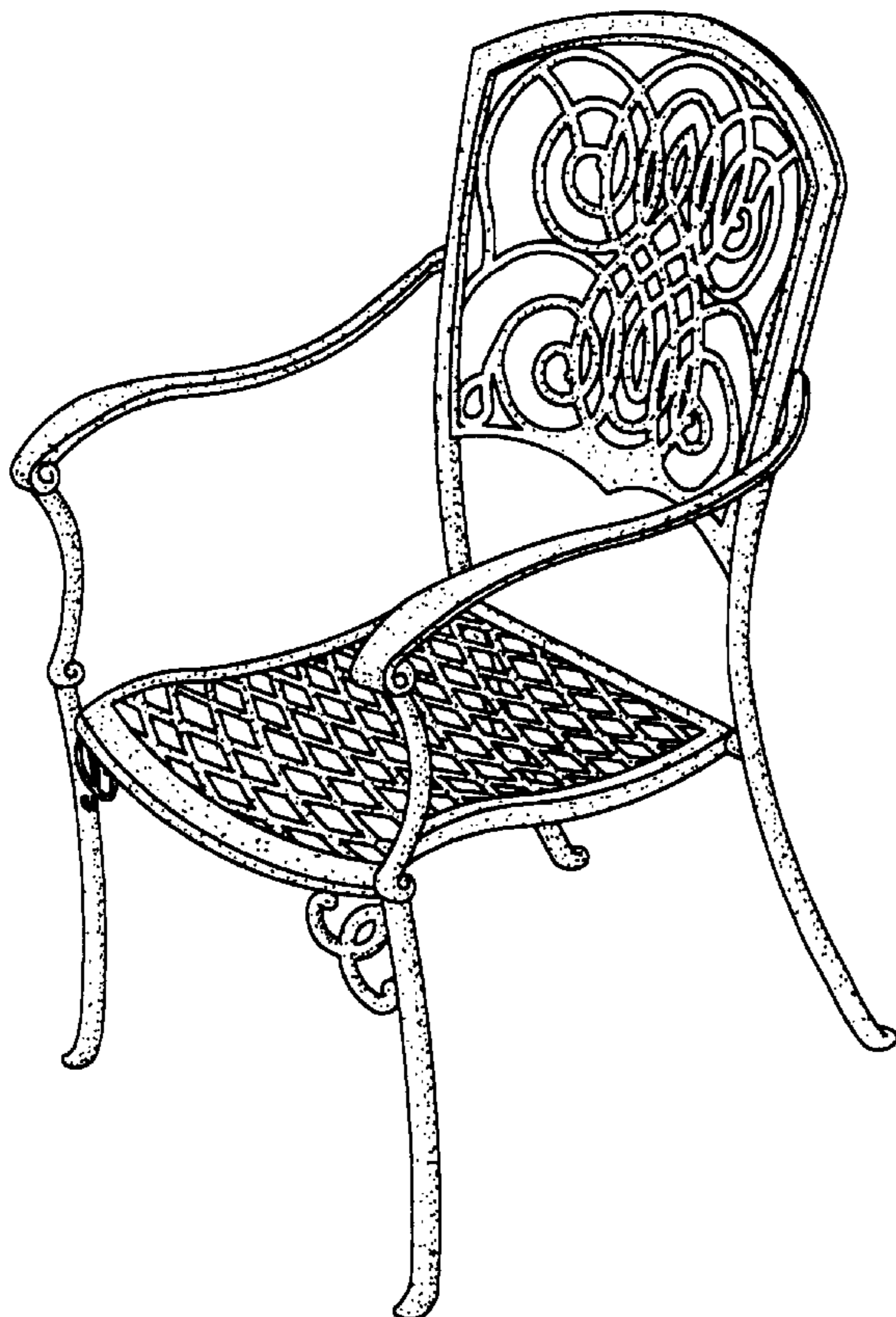

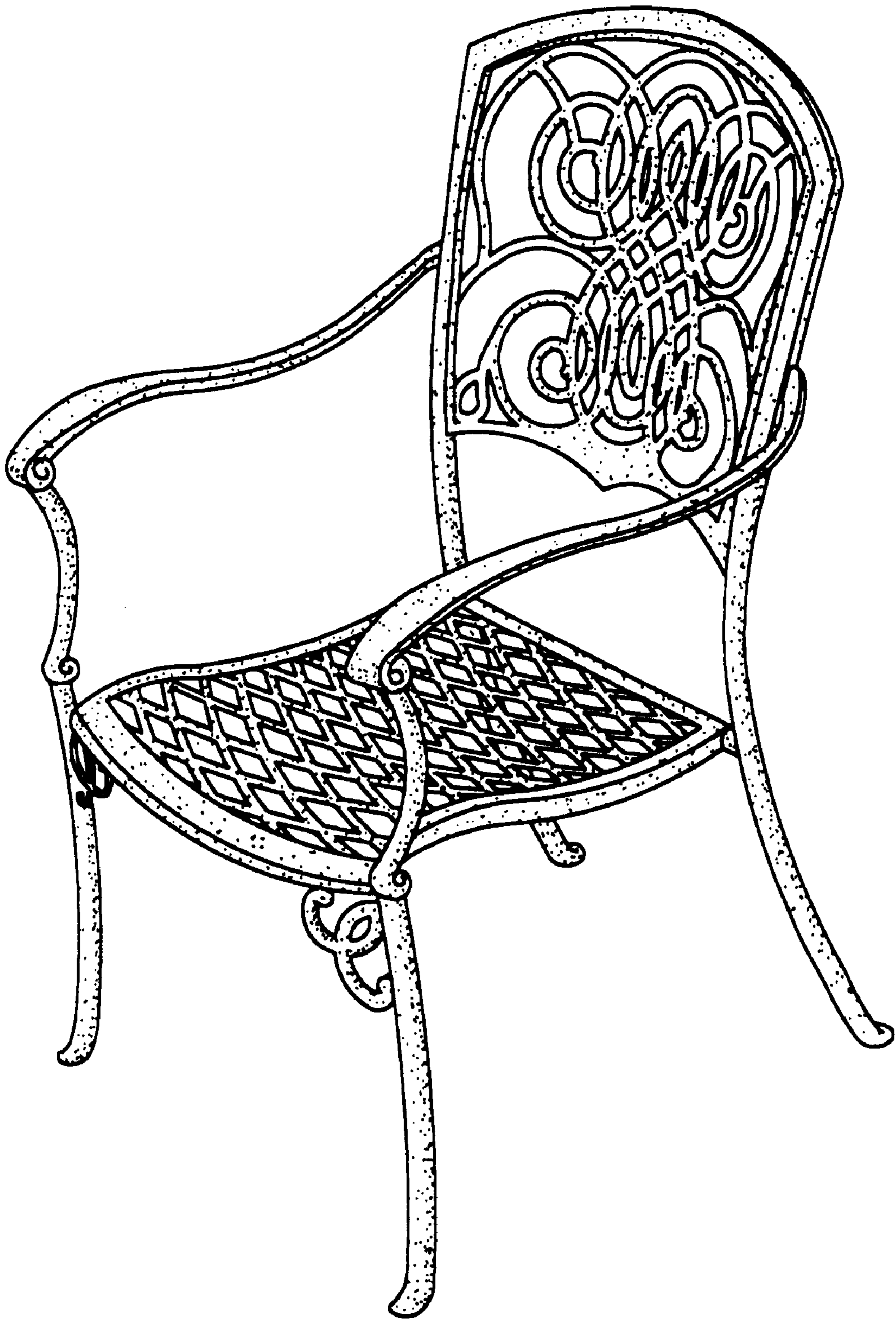

FIG. 1

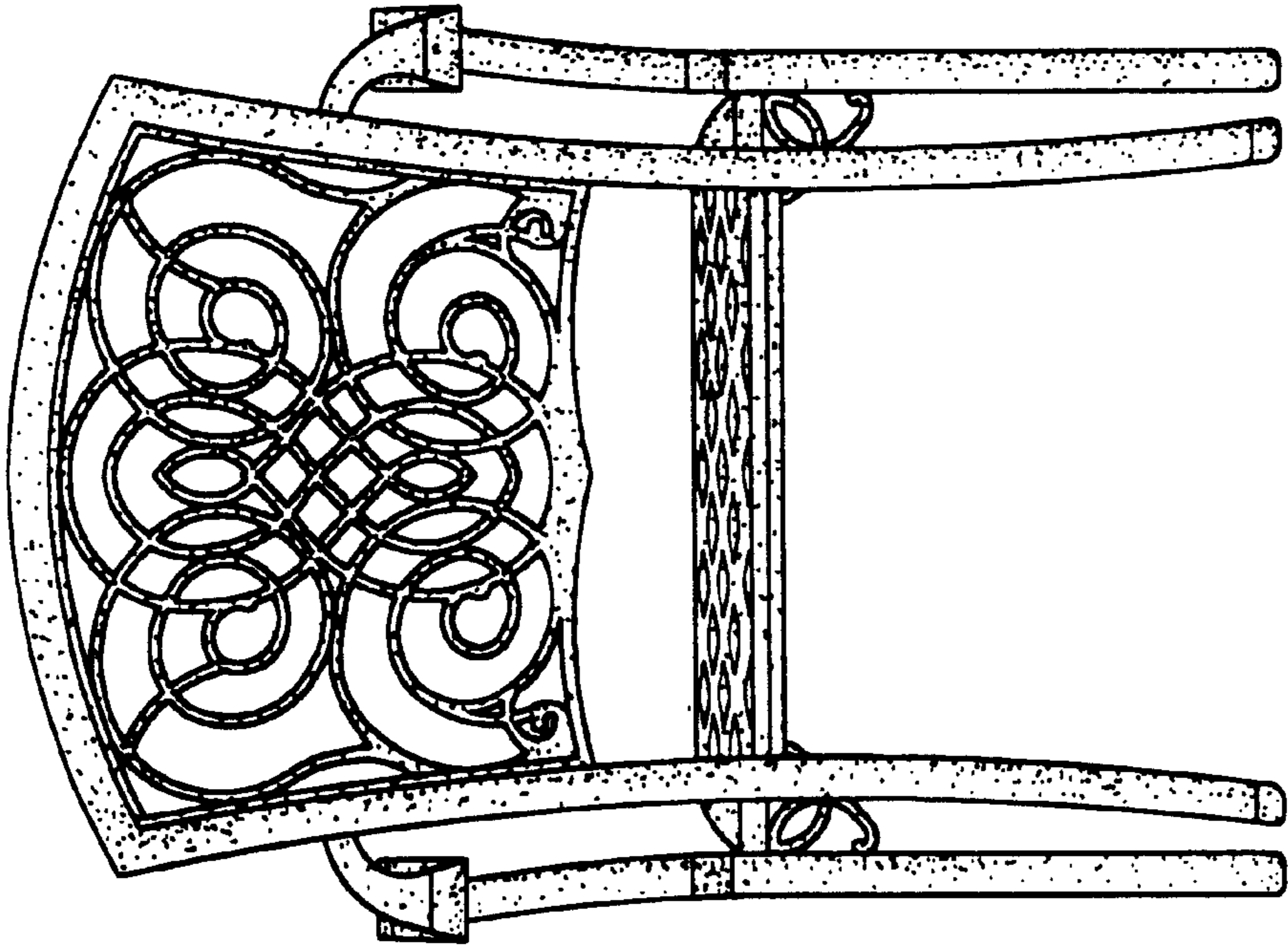

FIG. 3

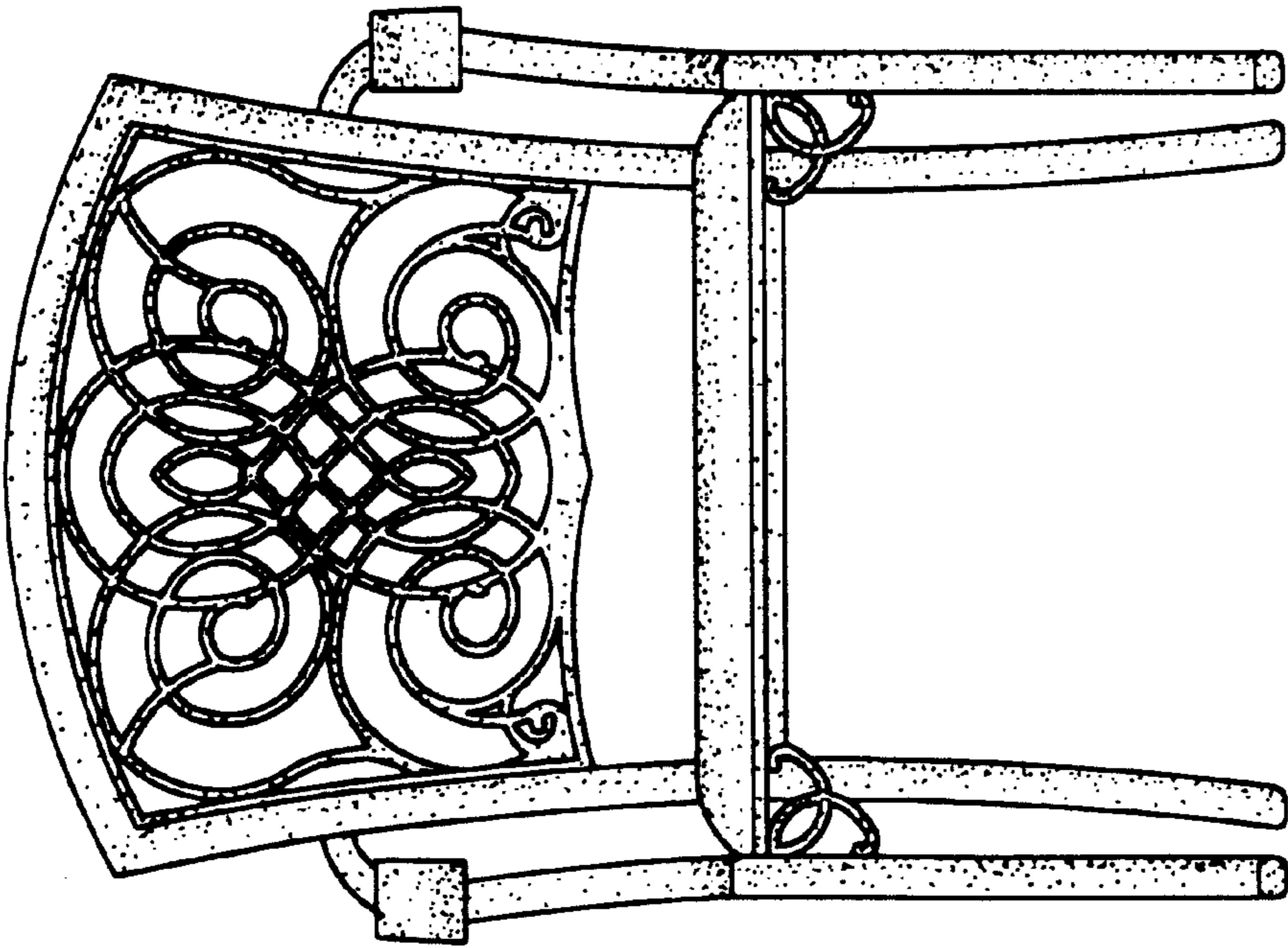

FIG. 2

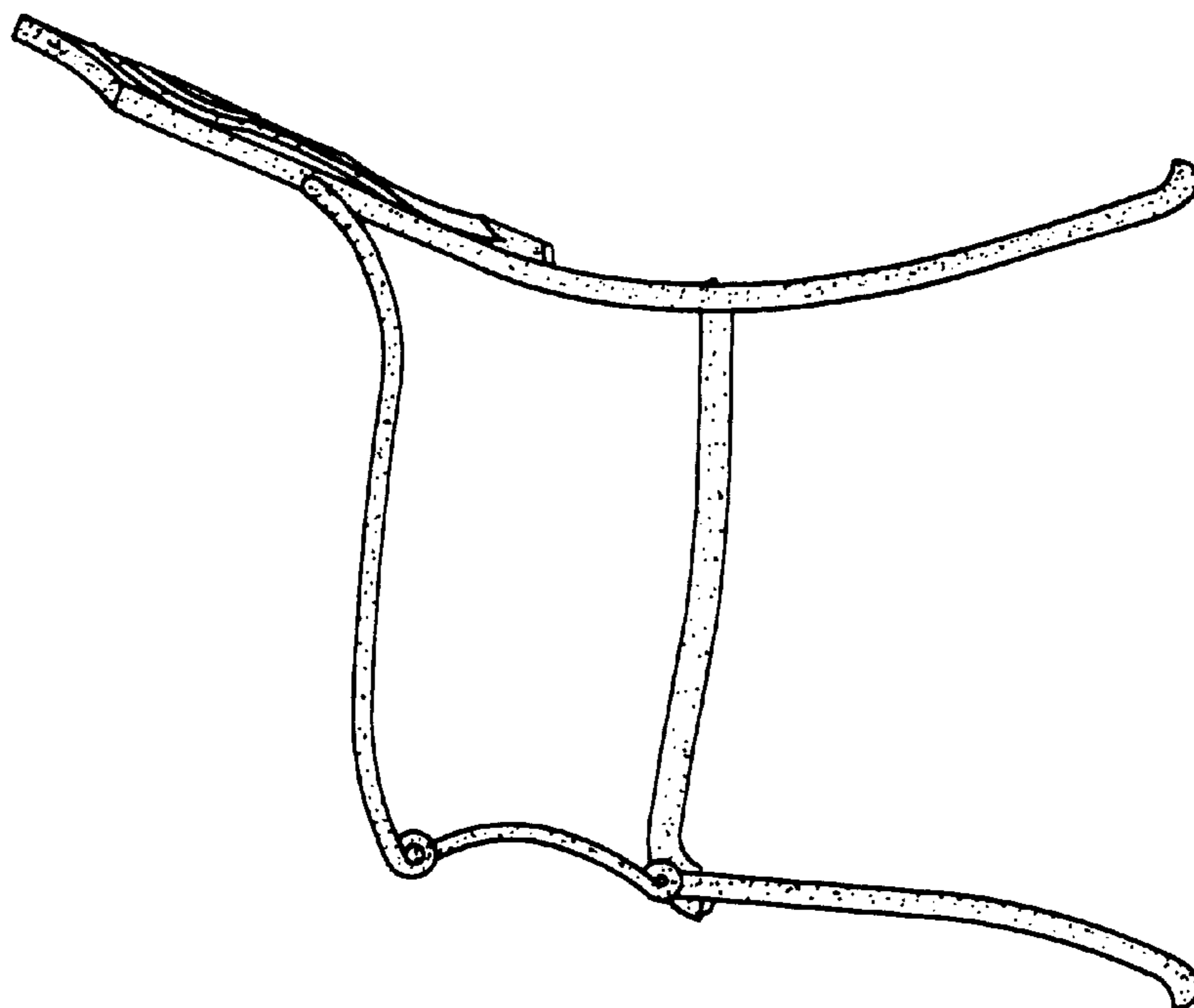

FIG. 5

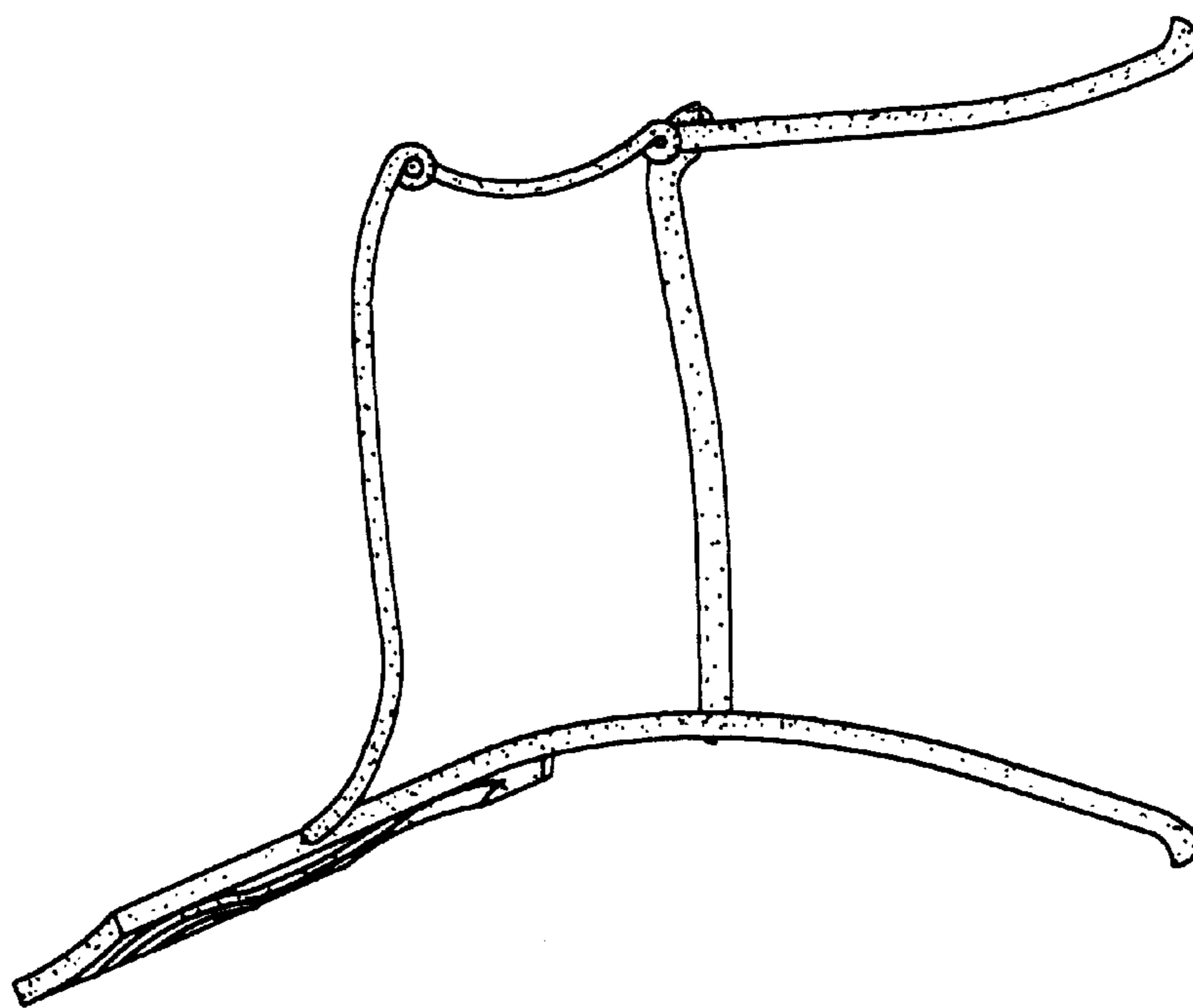

FIG. 4

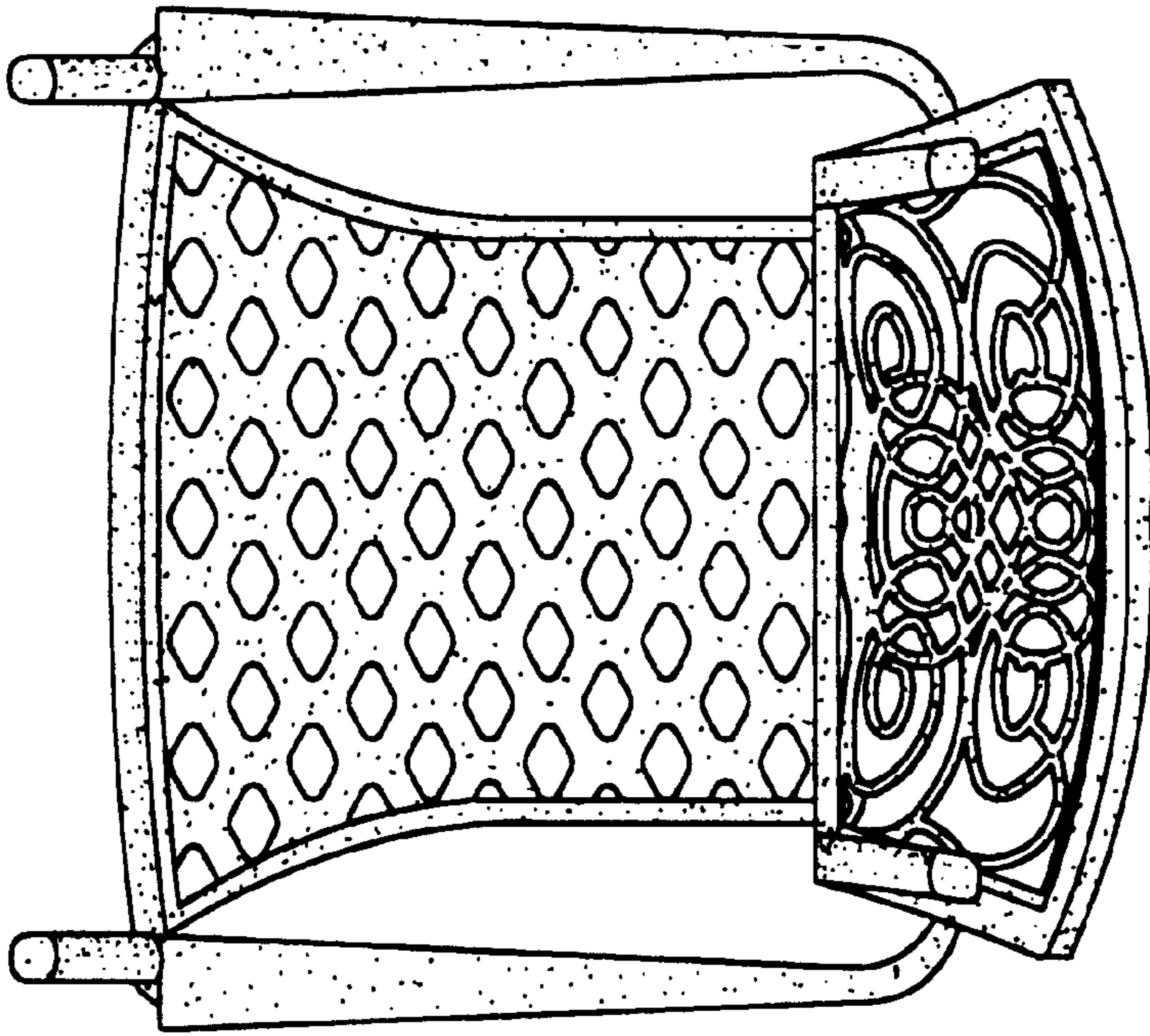

FIG. 7

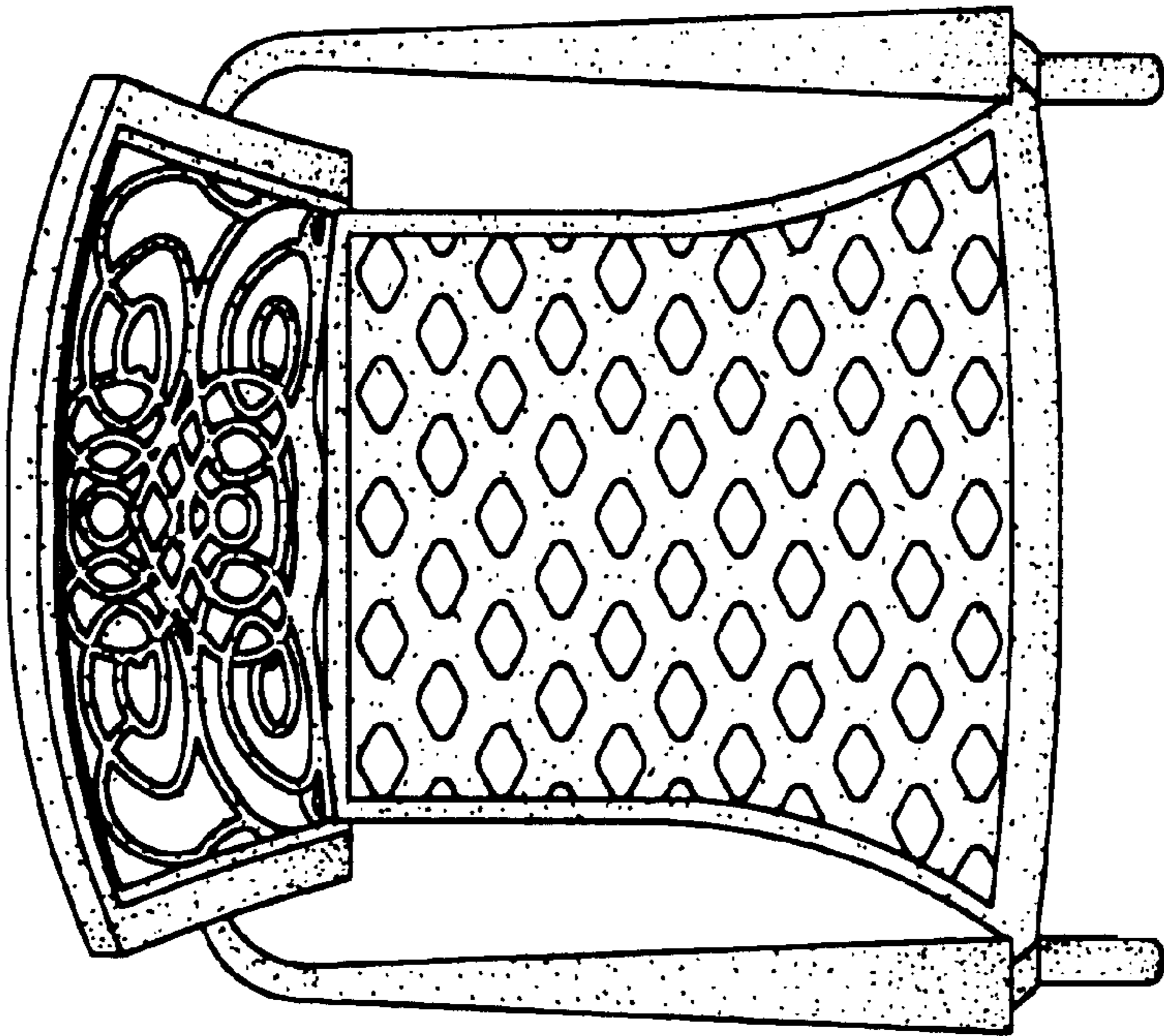

FIG. 6

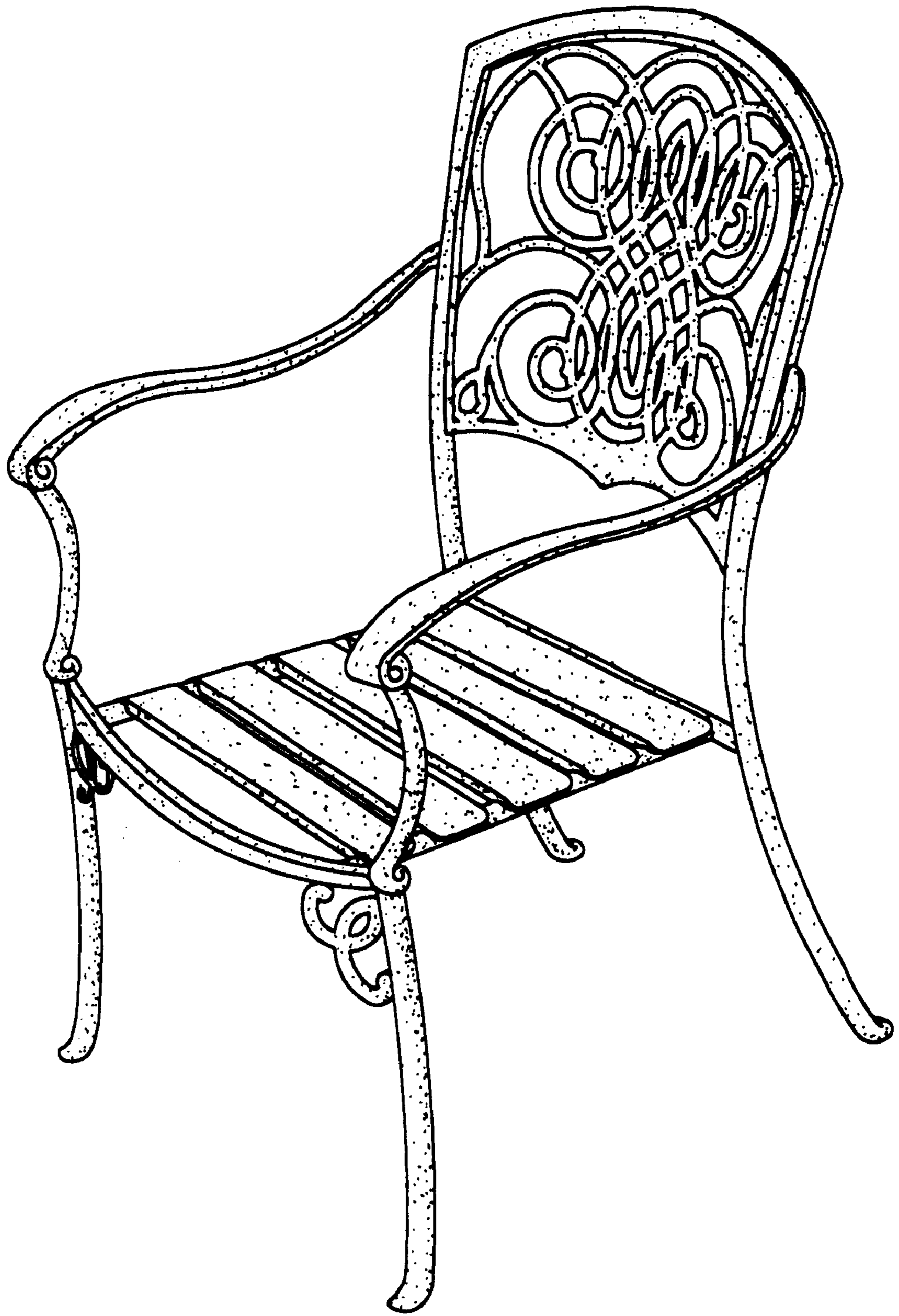

FIG. 8

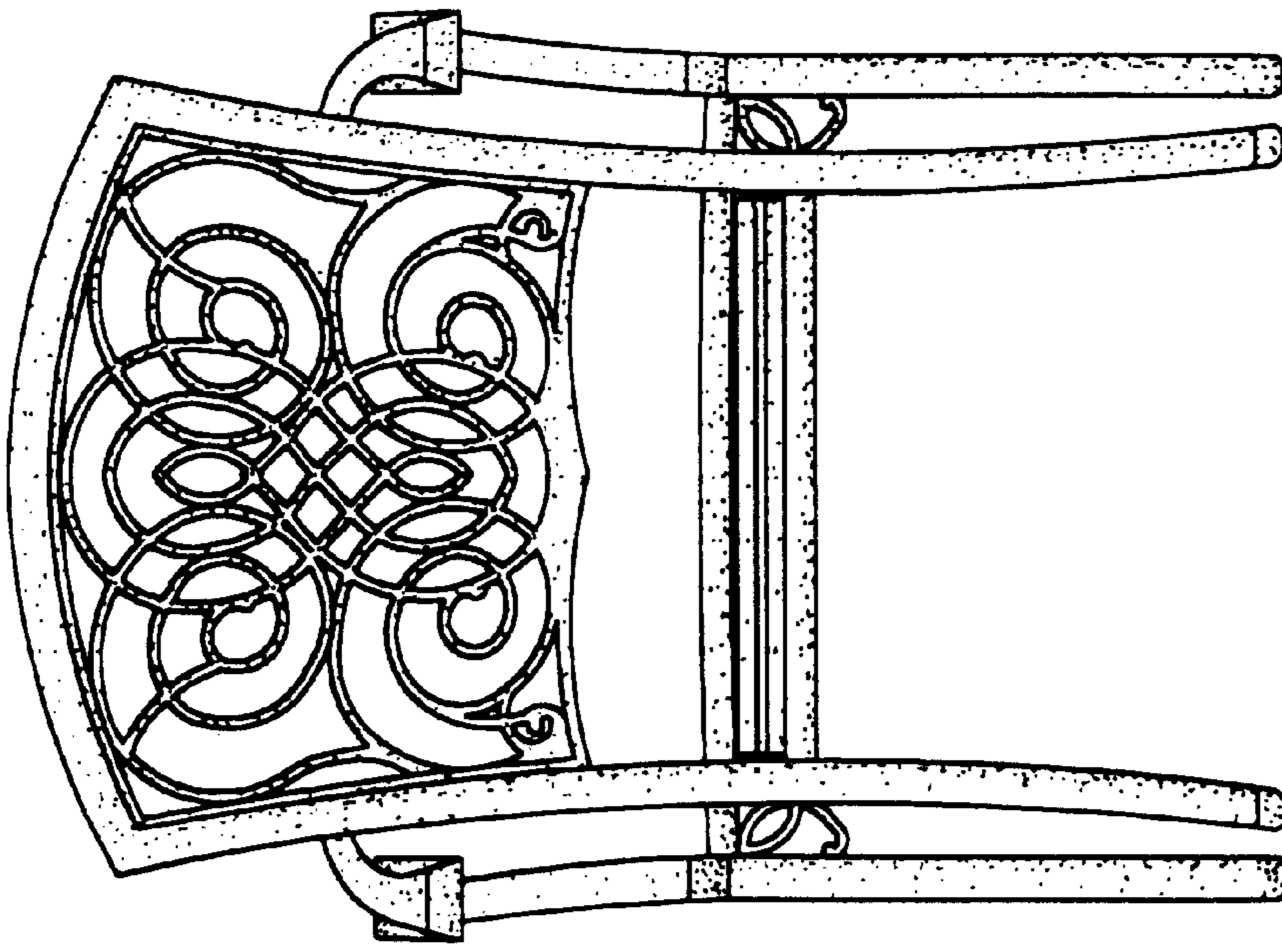

FIG. 9

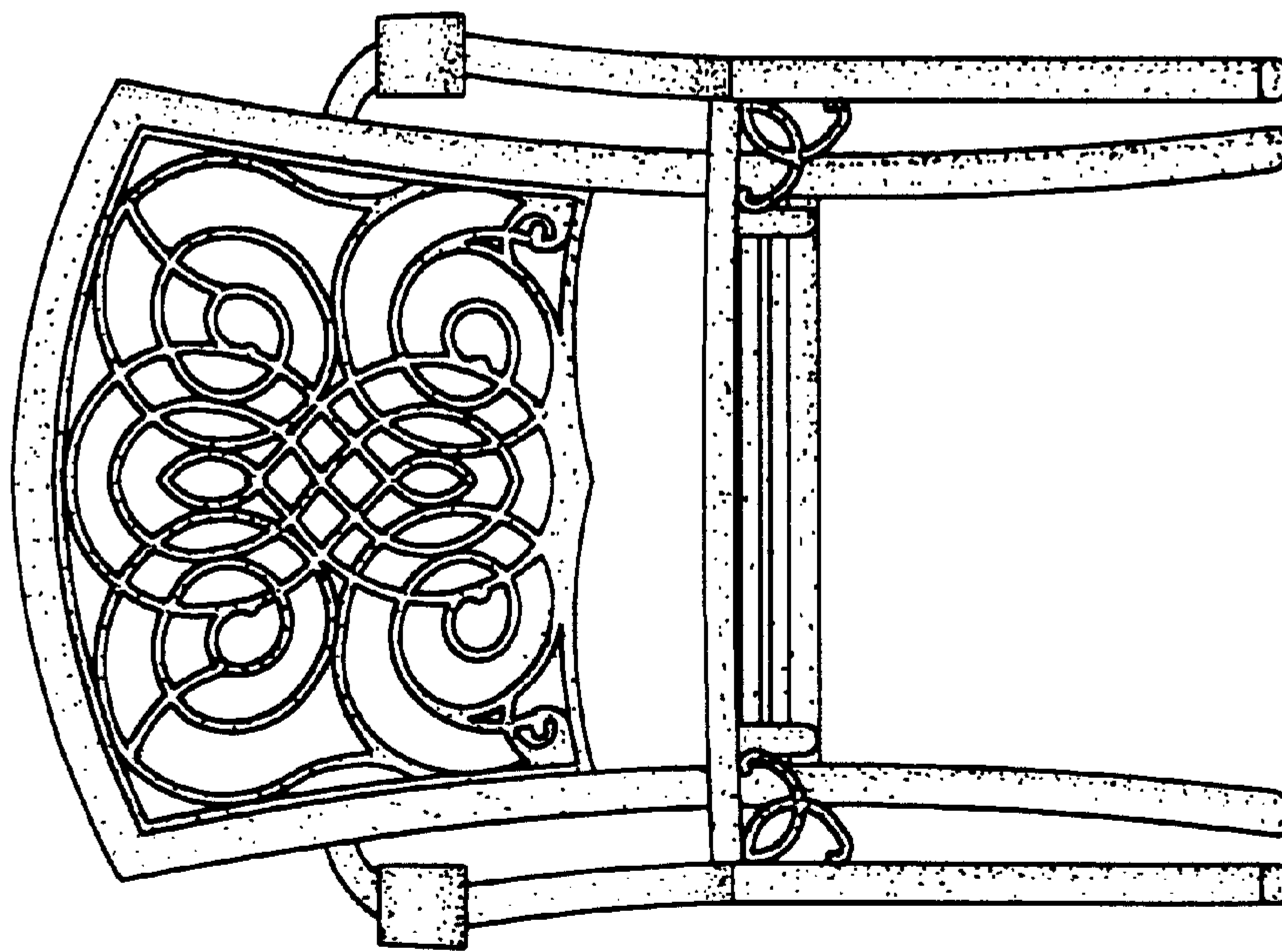

FIG. 10

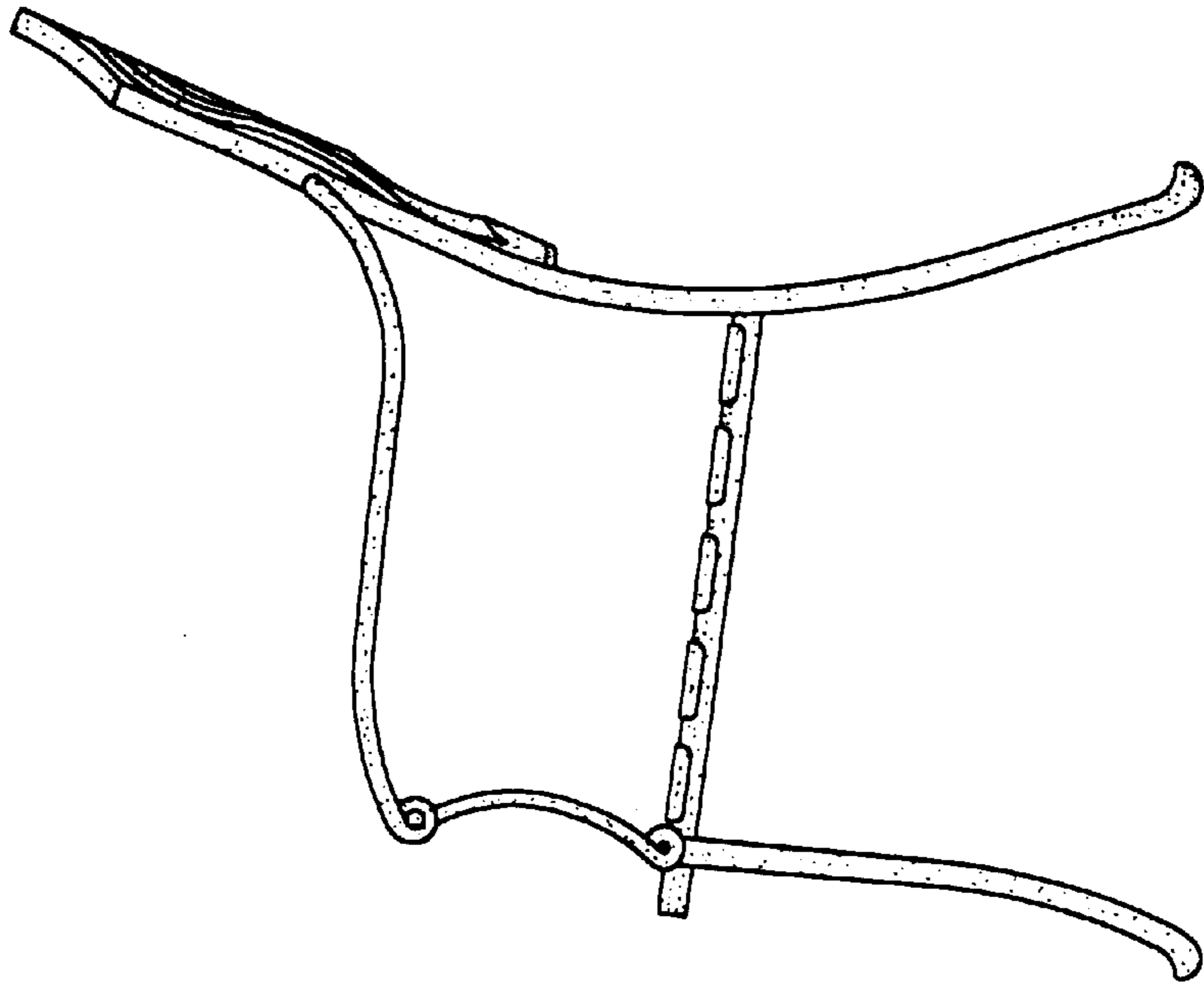

FIG. 12

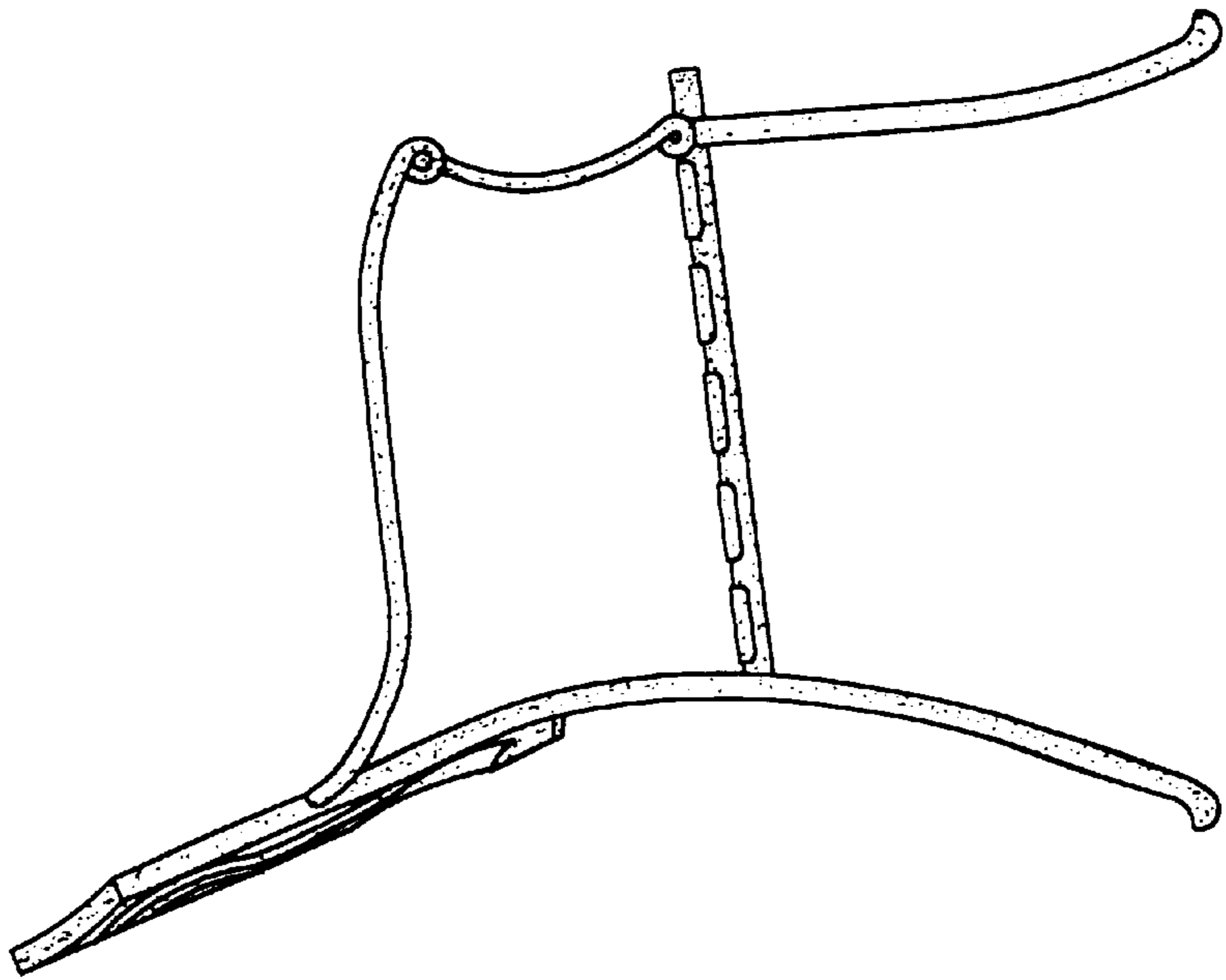

FIG. 11

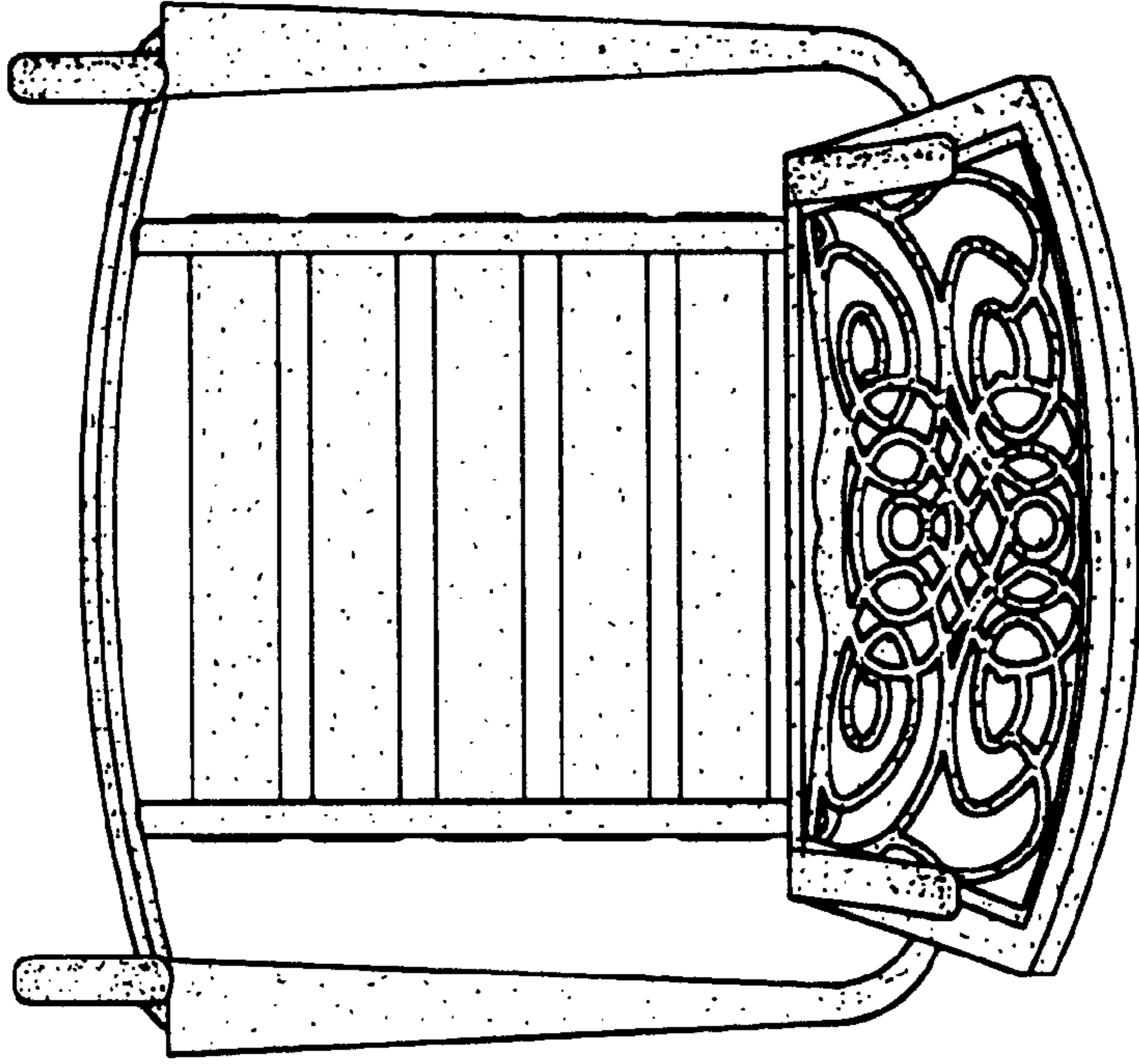

FIG. 13

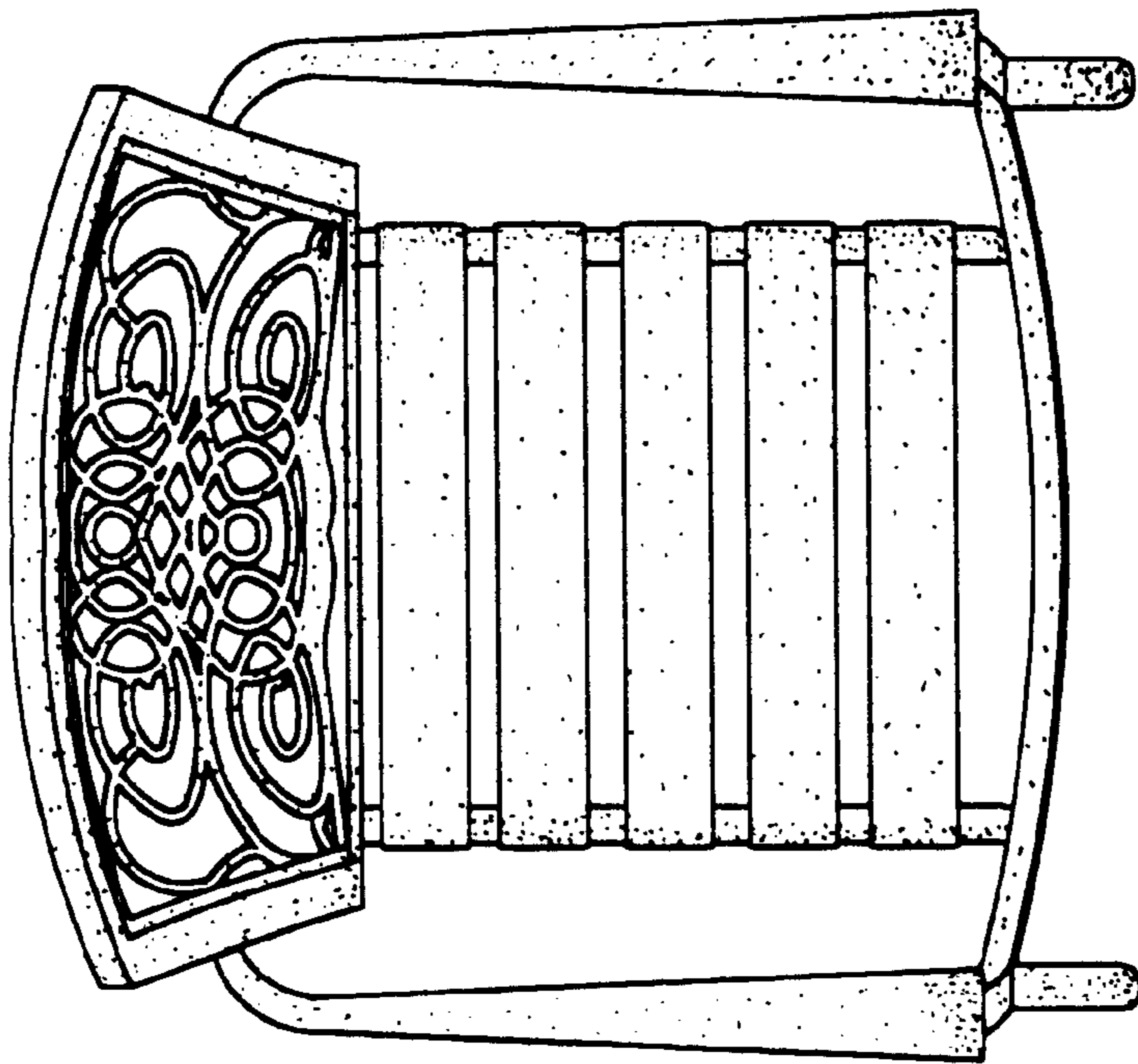

FIG. 14