



US00D454656S

(12) **United States Design Patent**  
**Berset et al.**

(10) **Patent No.: US D454,656 S**  
(45) **Date of Patent: \*\* Mar. 19, 2002**

(54) **ASHTRAY**

(75) Inventors: **Jacques Berset**, Fribourg (CH);  
**Thomas Riedel**, London (GB)

(73) Assignee: **Philip Morris Incorporated**, New York, NY (US)

(\*\*) Term: **14 Years**

(21) Appl. No.: **29/101,760**

(22) Filed: **Mar. 11, 1999**

(30) **Foreign Application Priority Data**

Sep. 11, 1998 (GB) ..... 2 077 564

(51) **LOC (7) Cl.** ..... **27-03**

(52) **U.S. Cl.** ..... **D27/102; D27/133**

(58) **Field of Search** ..... D27/102, 103,  
D27/105, 106, 110, 133, 134, 135; D9/420,  
423, 428; 131/231, 235.1, 237.5, 240.1,  
241, 242, 242.6

(56) **References Cited**

**U.S. PATENT DOCUMENTS**

2,565,864 A *	8/1951	Lindsey	.....	131/235.1
D218,132 S *	7/1970	Biegen	.....	D27/135
D239,248 S *	3/1976	Pinguely	.....	D27/105
D361,154 S *	8/1995	Makinen	.....	D27/135
D370,081 S *	5/1996	Mauldin	.....	D27/105
D371,963 S *	7/1996	Ahern	.....	D9/428

\* cited by examiner

*Primary Examiner*—Susan J. Lucas

*Assistant Examiner*—Jennifer Rivard

(74) *Attorney, Agent, or Firm*—Connolly Bove Lodge & Hutz LLP

(57) **CLAIM**

The ornamental design for an ashtray, as shown and described.

**DESCRIPTION**

FIG. 1 is a perspective view of an ashtray with the cover closed showing our new design;

FIG. 2 is a perspective view thereof with the cover open; FIG. 3 is a front elevational view thereof with the cover closed;

FIG. 4 is a rear elevational view thereof with the cover closed;

FIG. 5 is a top plan view thereof with the cover closed;

FIG. 6 is a bottom plan view thereof;

FIG. 7 is a right side elevational view thereof with the cover closed, the left side elevational view being a mirror image duplicate;

FIG. 8 is a perspective view of an alternate ashtray with the cover closed showing our new design;

FIG. 9 is a perspective view thereof with the cover open;

FIG. 10 is a front elevational view thereof with the cover closed;

FIG. 11 is a rear elevational view thereof with the cover closed;

FIG. 12 is a top plan view thereof with the cover closed;

FIG. 13 is a bottom plan view thereof;

FIG. 14 is a right side elevational view thereof with the cover closed, the left side elevational view being a mirror image duplicate;

FIG. 15 is a perspective view of an alternate ashtray with the cover closed showing our new design;

FIG. 16 is a perspective view thereof with the cover open;

FIG. 17 is a front elevational view thereof with the cover closed;

FIG. 18 is a rear elevational view thereof with the cover closed;

FIG. 19 is a top plan view thereof with the cover closed;

FIG. 20 is a bottom plan view thereof;

FIG. 21 is a right side elevational view thereof with the cover closed, the left side elevational view being a mirror image duplicate;

FIG. 22 is a perspective view of an alternate ashtray with the cover closed showing our new design;

FIG. 23 is a perspective view thereof with the cover open;

FIG. 24 is a front elevational view thereof with the cover closed;

FIG. 25 is a rear elevational view thereof with the cover closed;

FIG. 26 is a top plan view thereof with the cover closed;

FIG. 27 is a bottom plan view thereof;

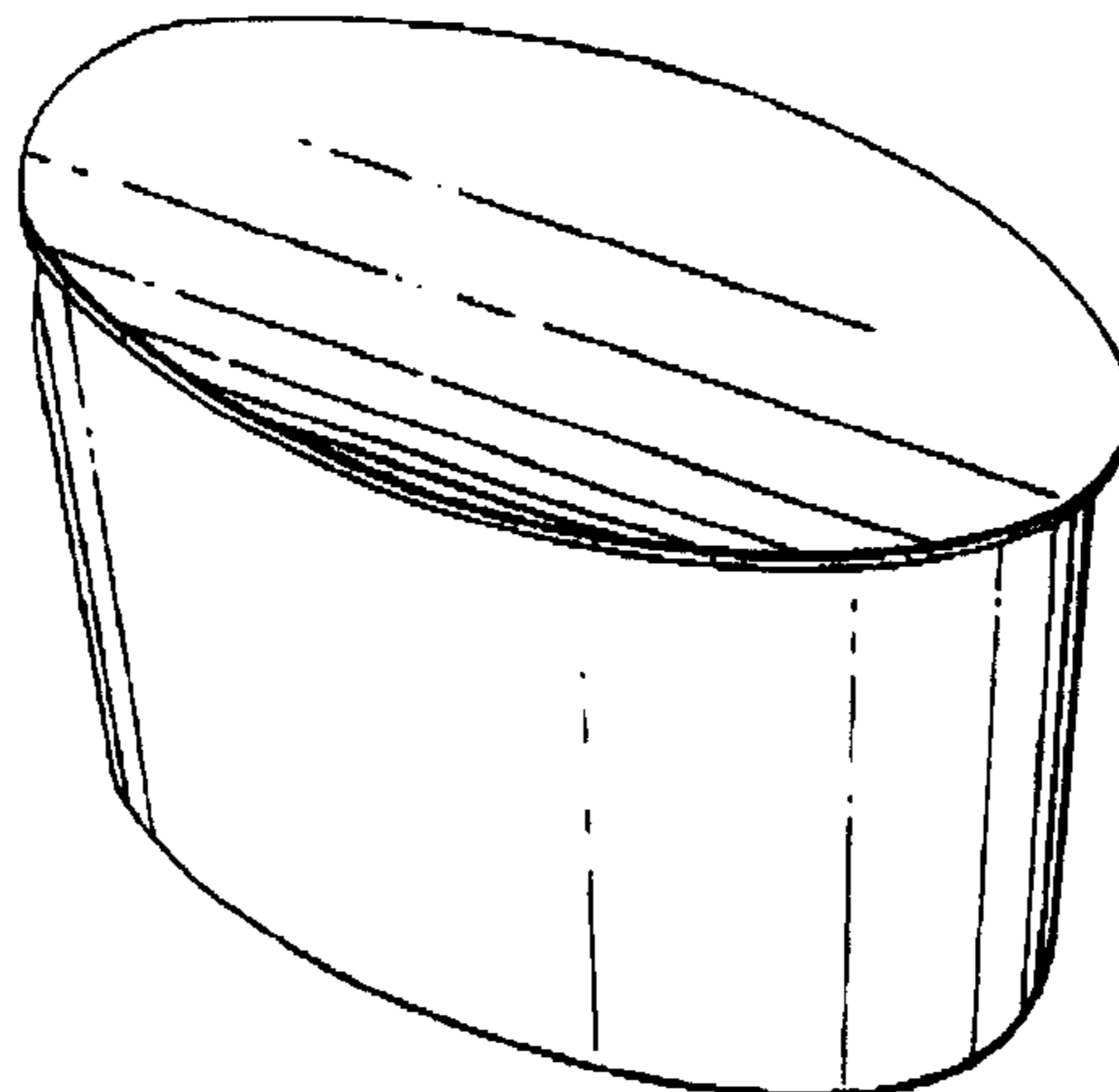

FIG. 28 is a right side elevational view thereof with the cover closed;

FIG. 29 is a left side elevational view thereof with the cover closed;

FIG. 30 is a perspective view of an alternate ashtray with the cover closed showing our new design;

FIG. 31 is a perspective view thereof with the cover open;

FIG. 32 is a front elevational view thereof with the cover closed;

FIG. 33 is a rear elevational view thereof with the cover closed;

FIG. 34 is a top plan view thereof with the cover closed;

FIG. 35 is a bottom plan view thereof;

FIG. 36 is a right side elevational view thereof with the cover closed, the left side elevational view being a mirror image duplicate; and,

FIG. 37 is a right side elevational view thereof with the cover open, the left side elevational view being a mirror image duplicate.

**1 Claim, 22 Drawing Sheets**

FIG. 1

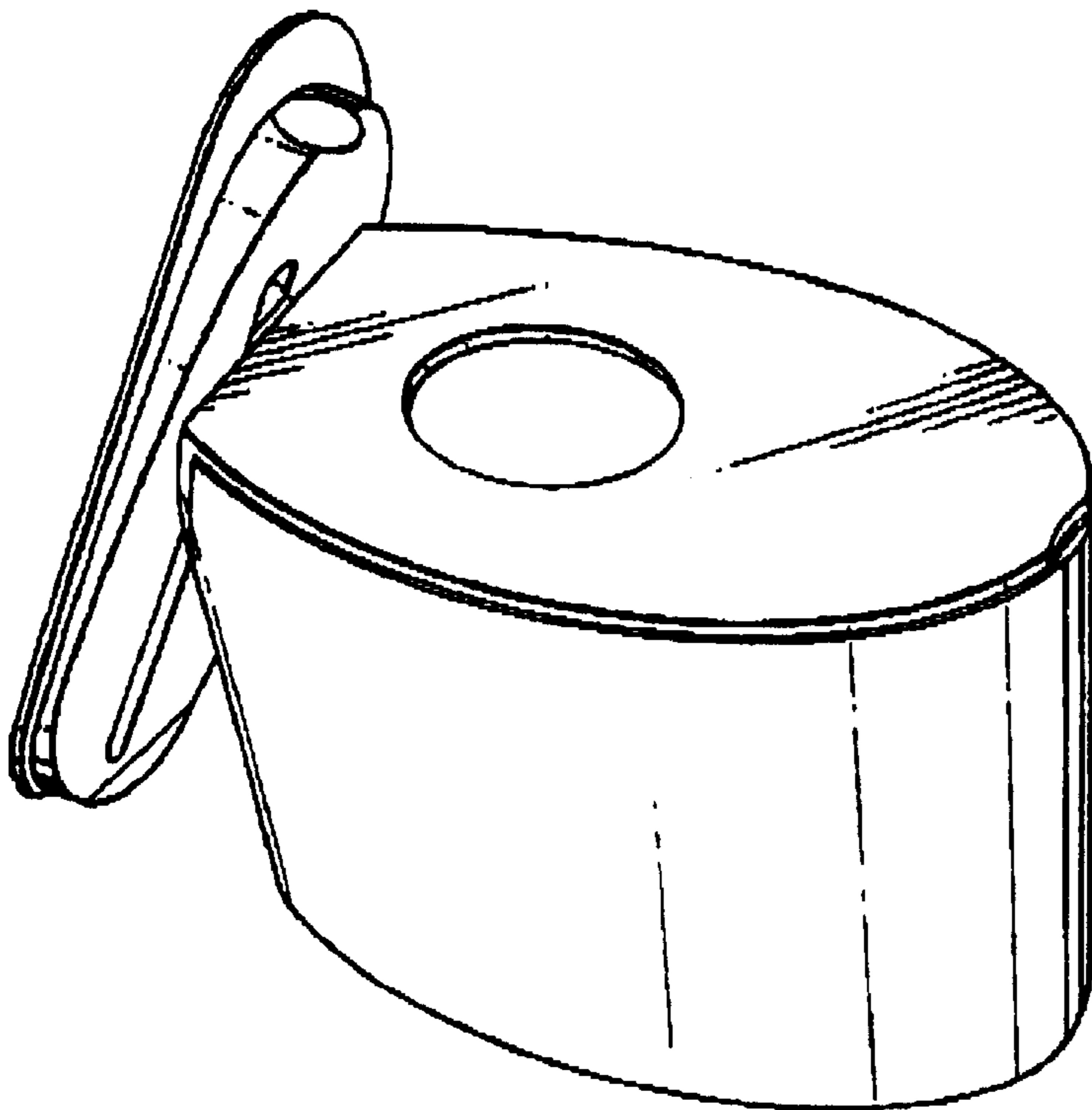
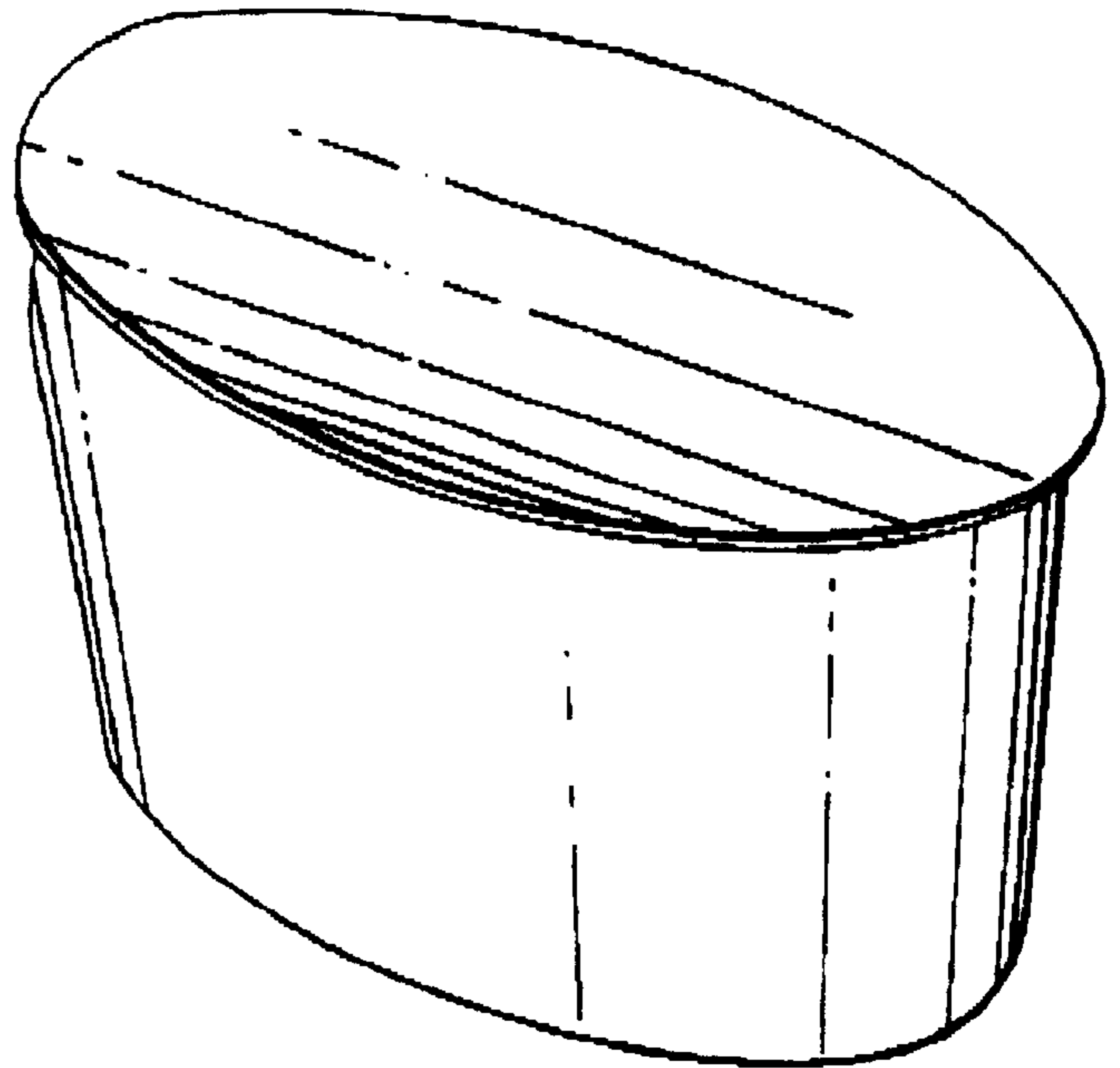

FIG. 2

FIG. 3

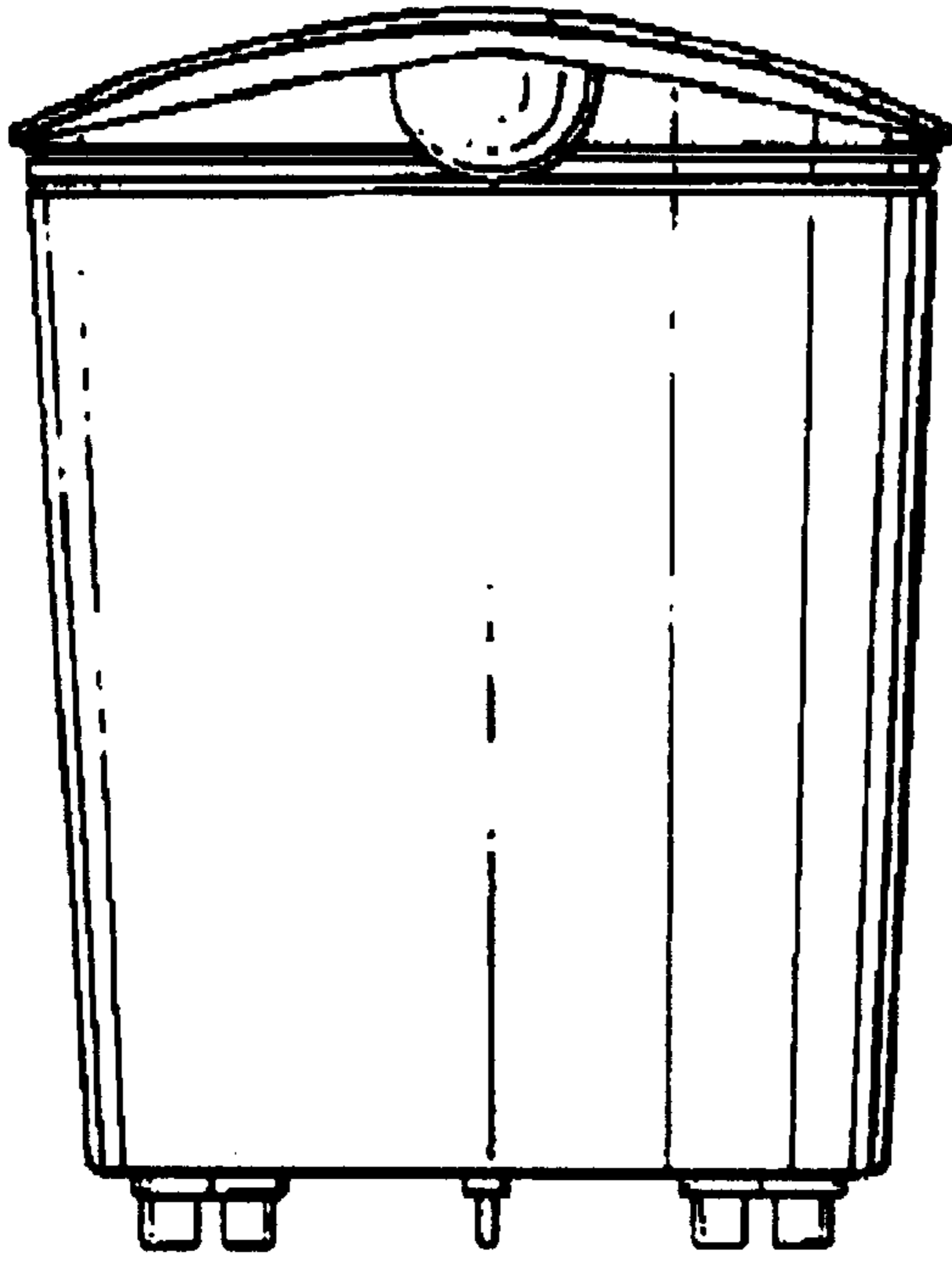

FIG. 4

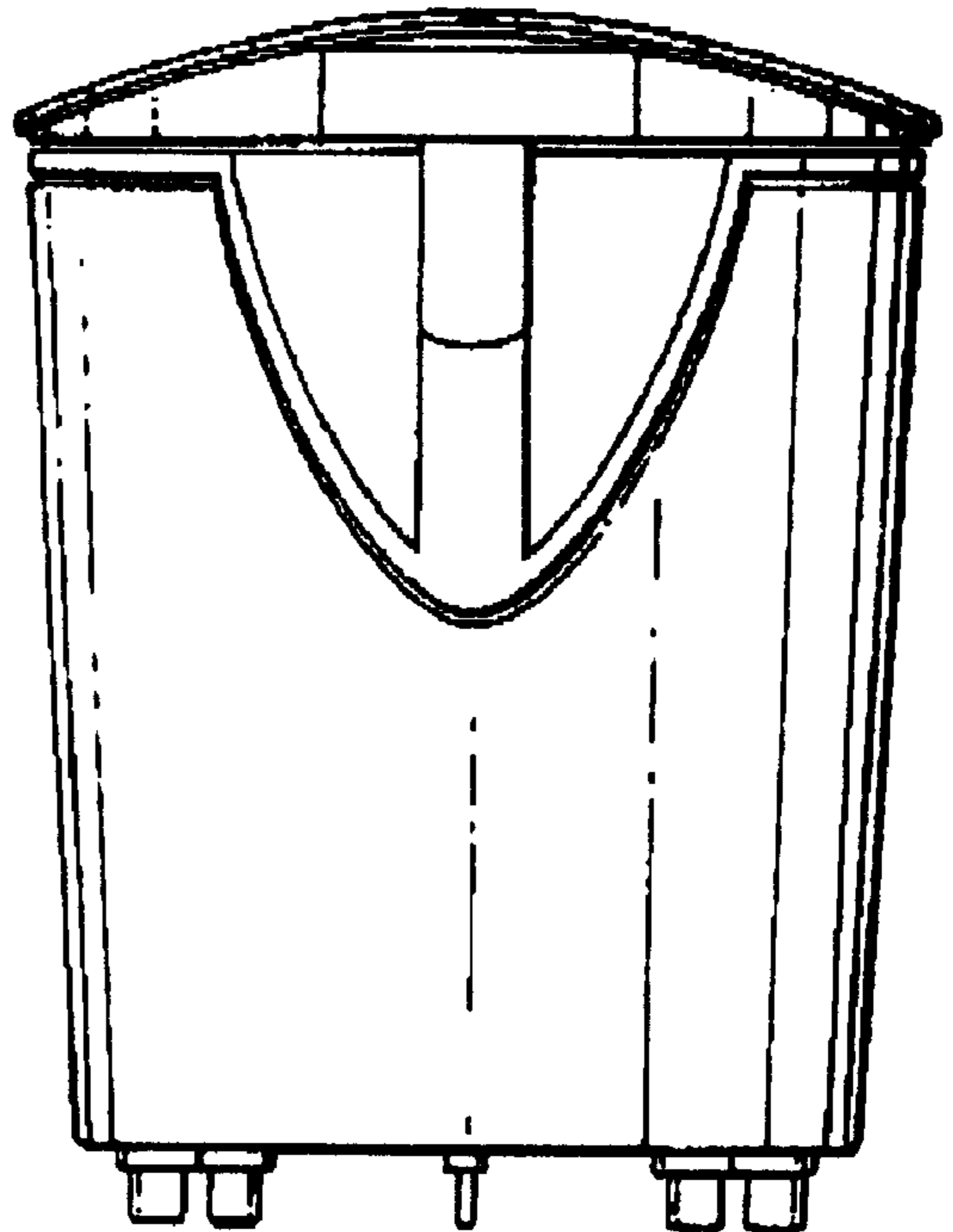

FIG. 5

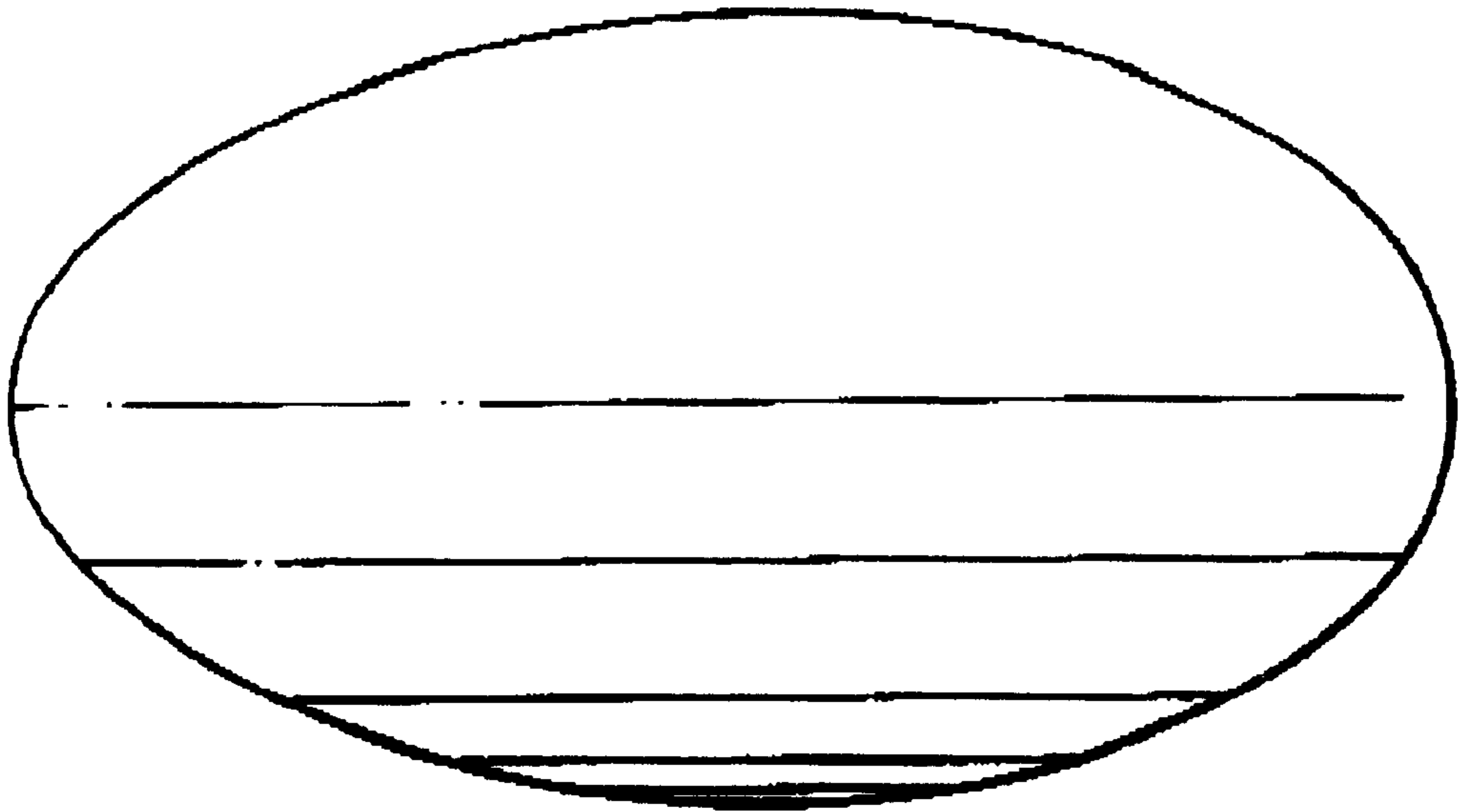

FIG. 6

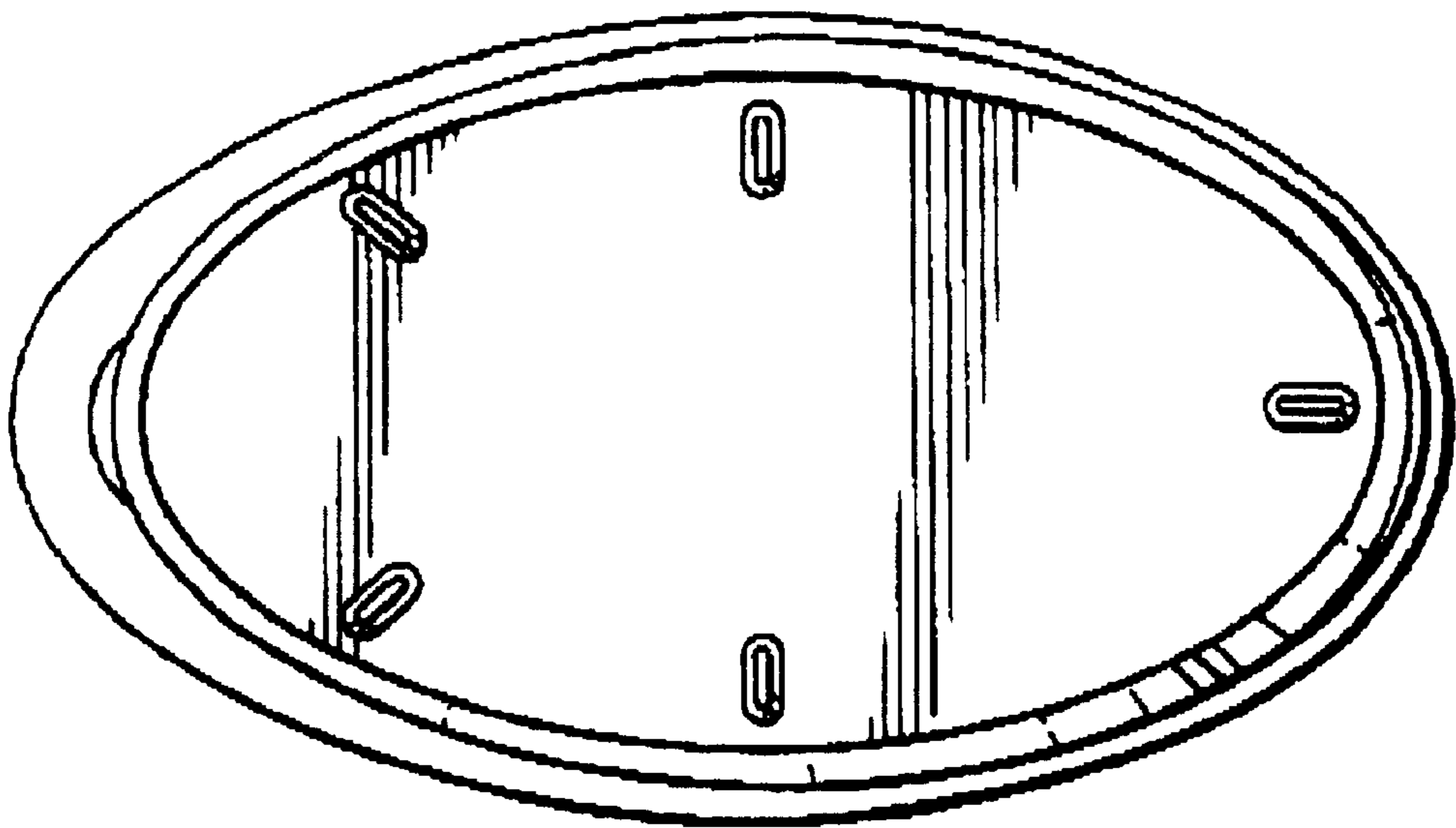

FIG. 7

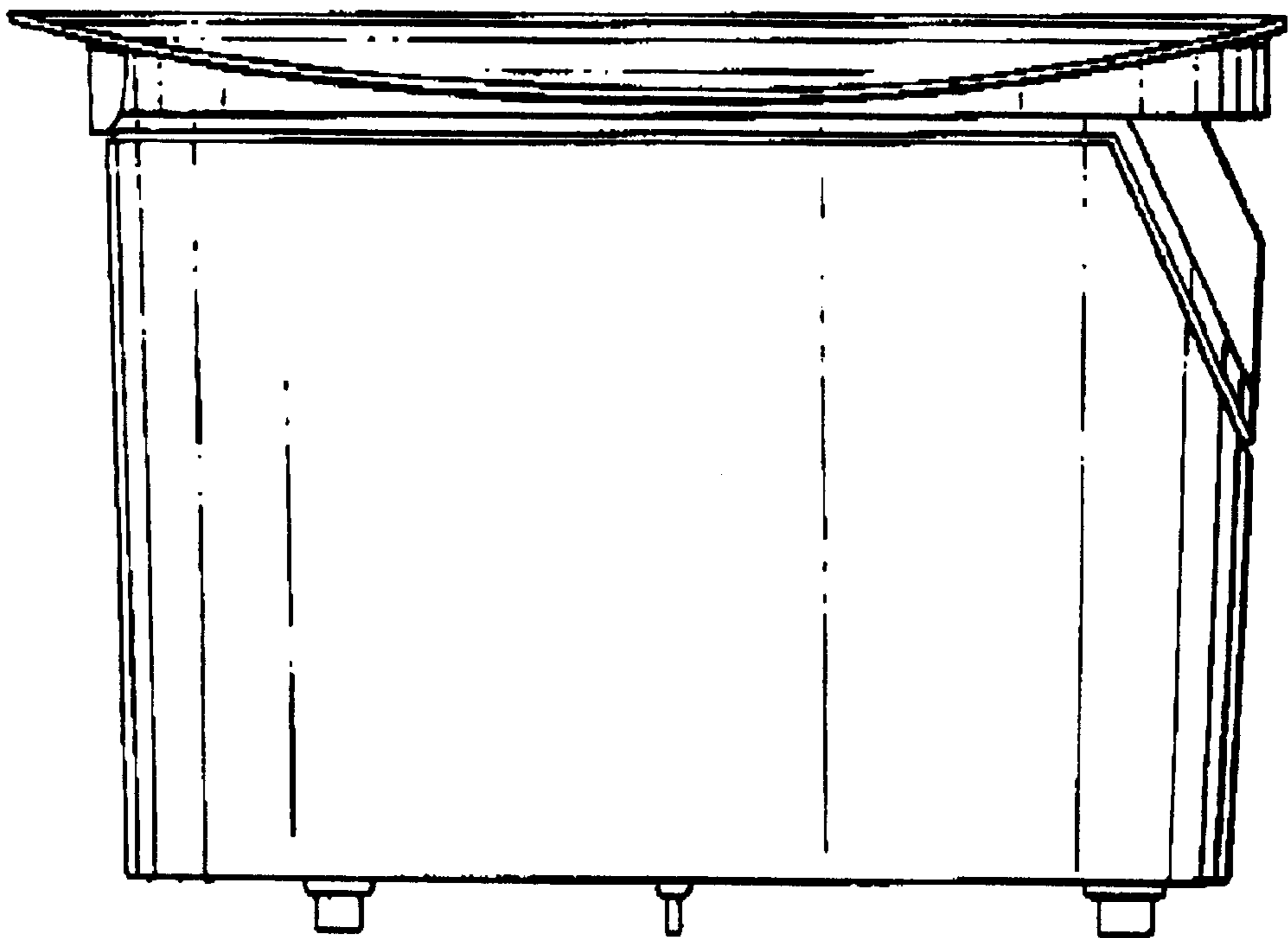

FIG. 8

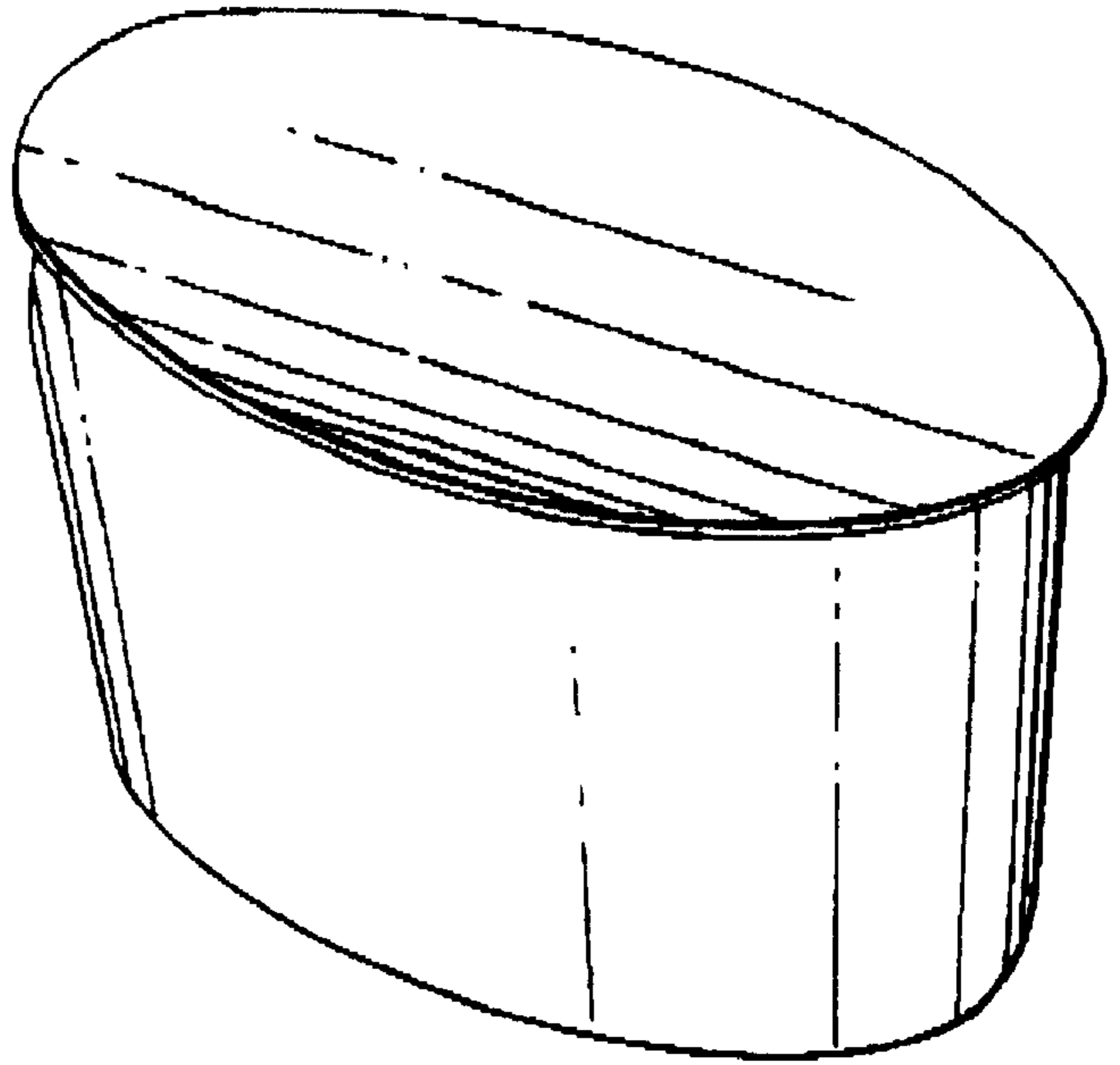

FIG. 9

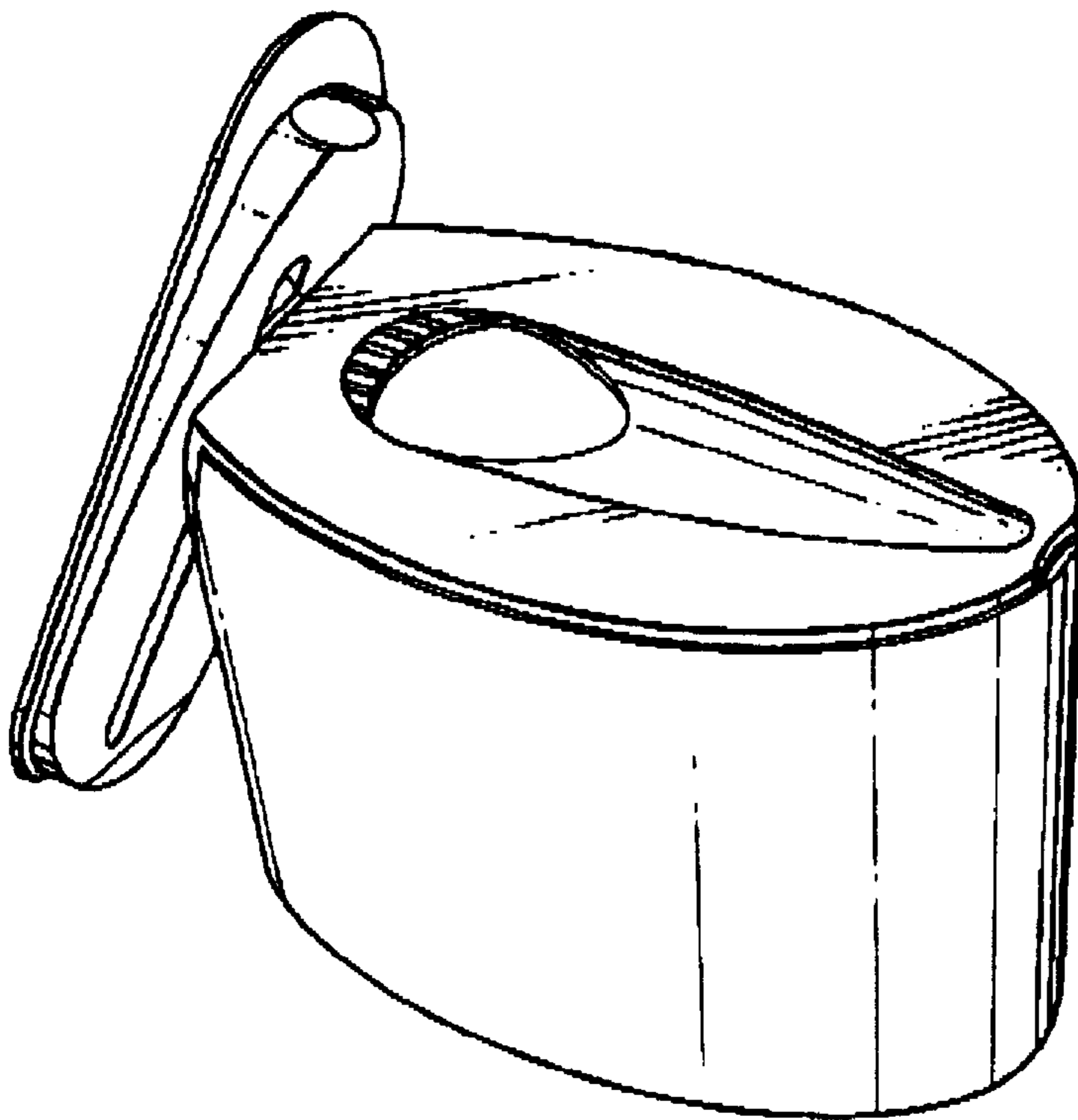

FIG. 10

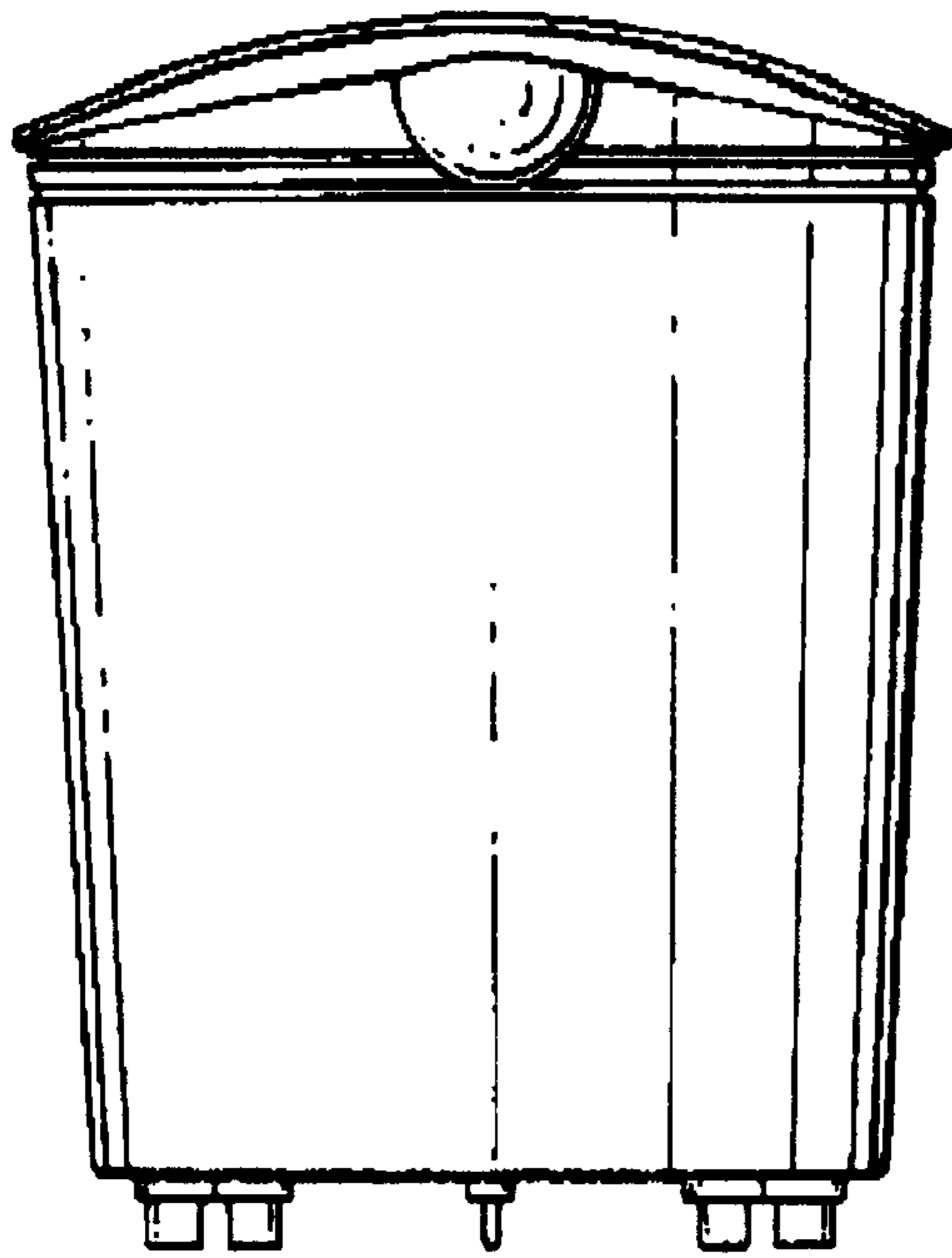

FIG. 11

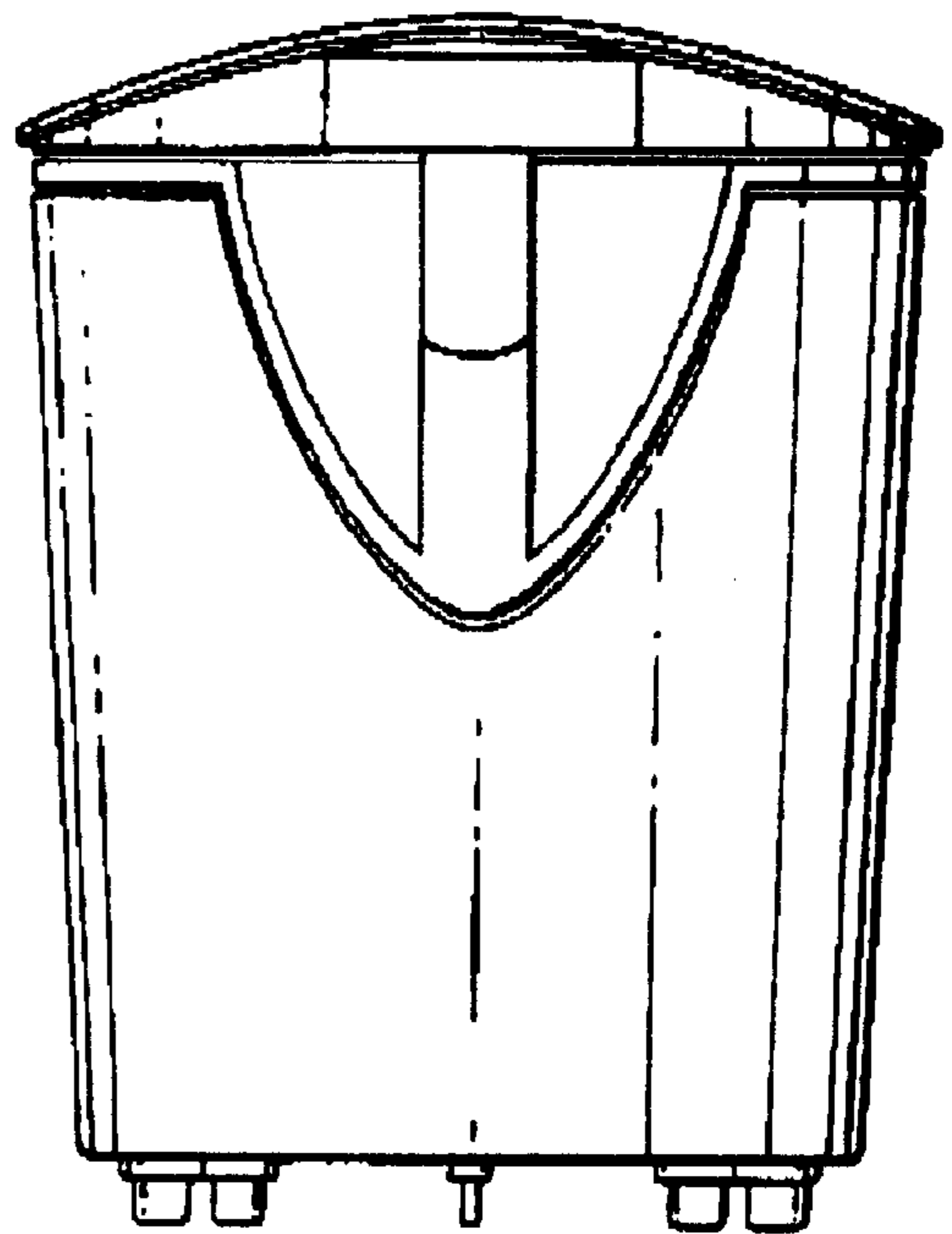



FIG. 12

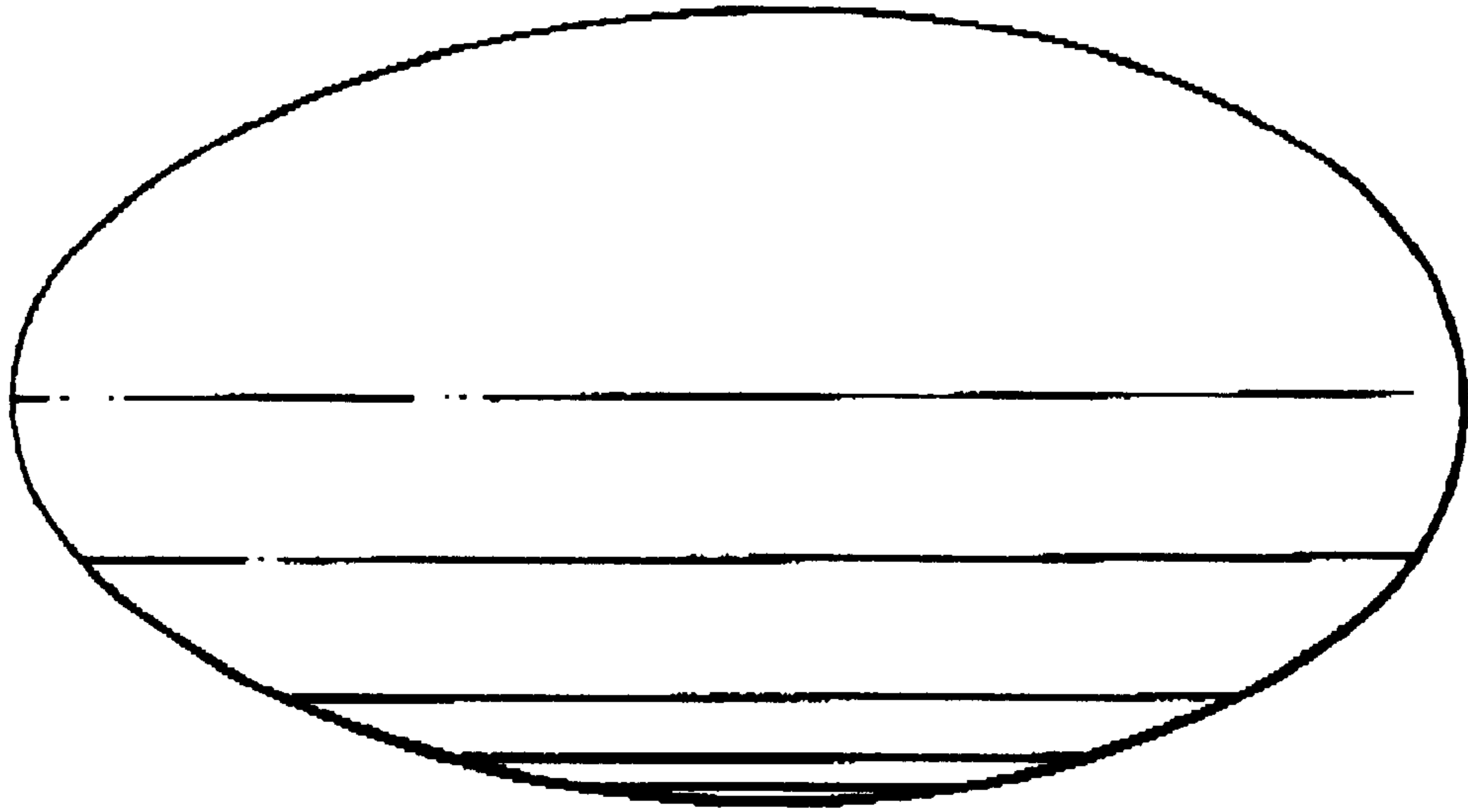

FIG. 13

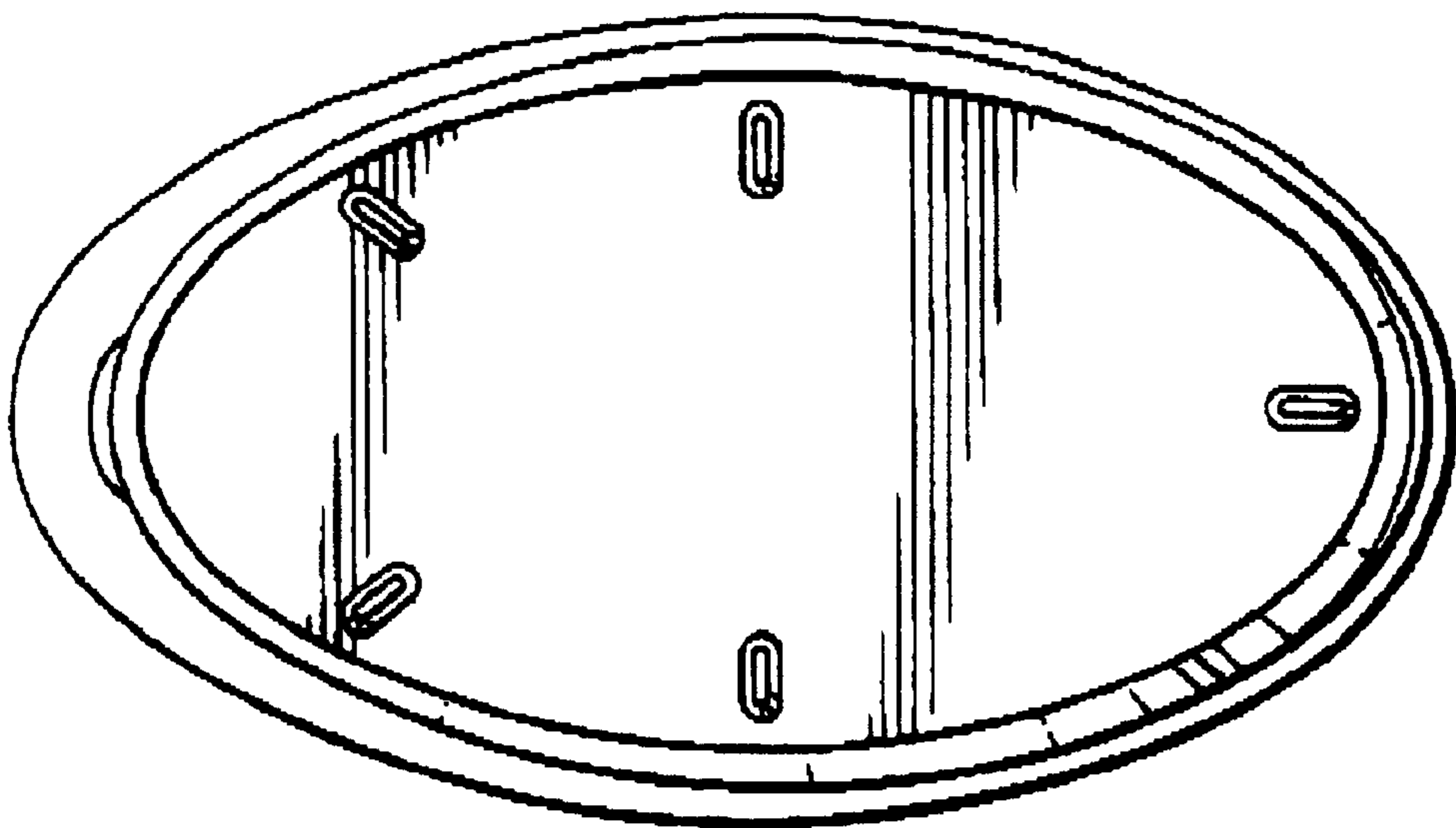

FIG. 14

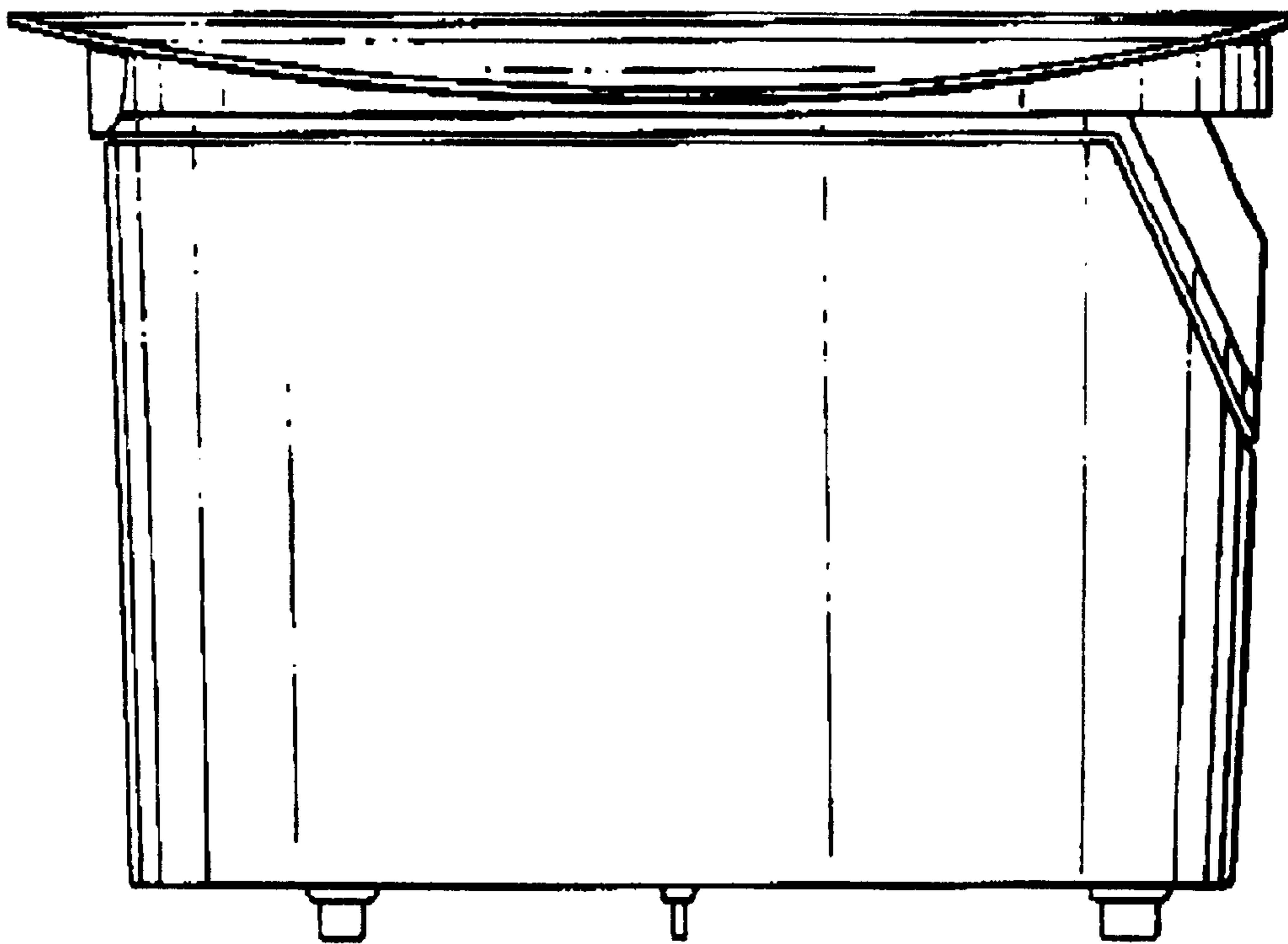

FIG. 15

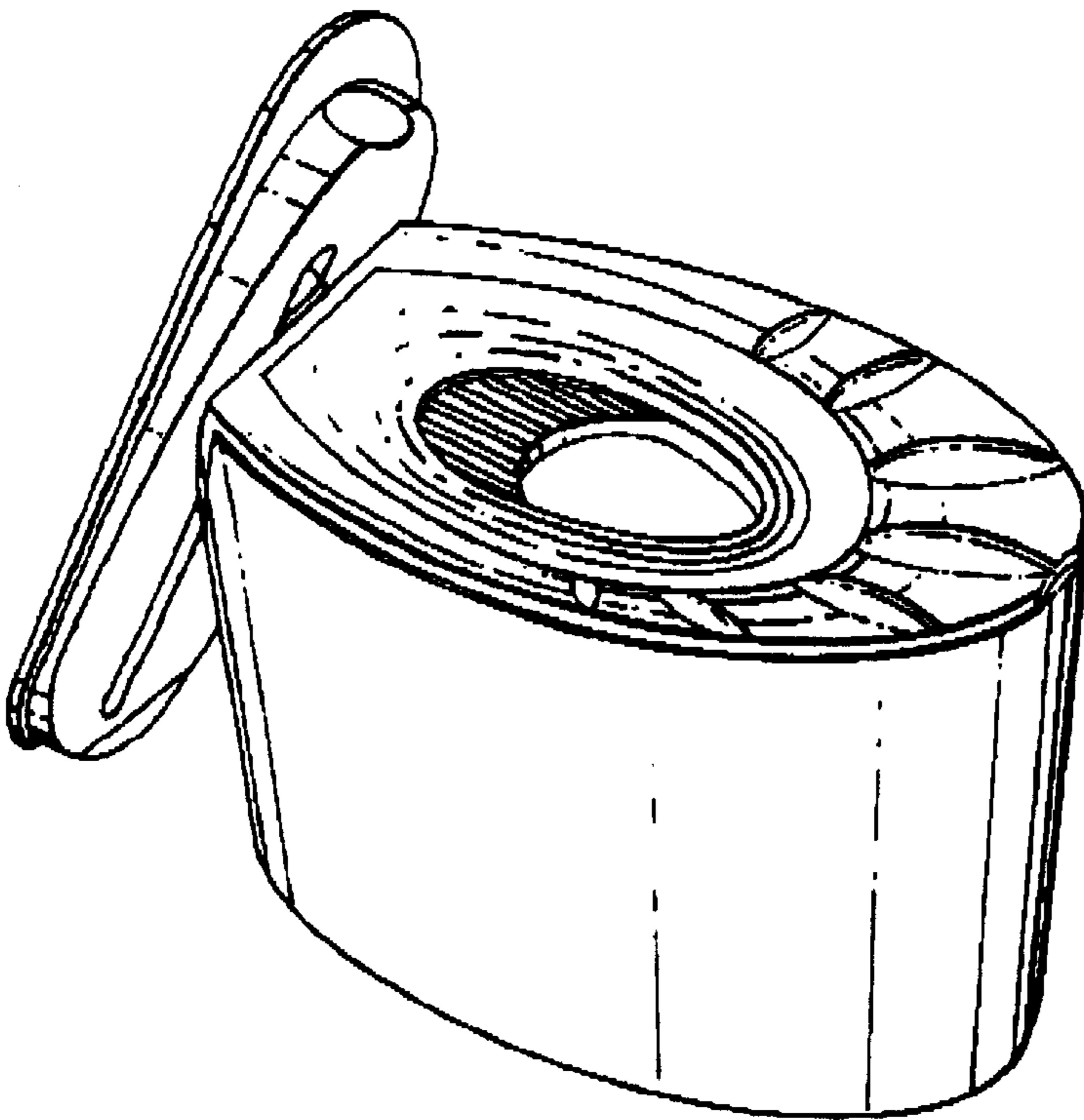
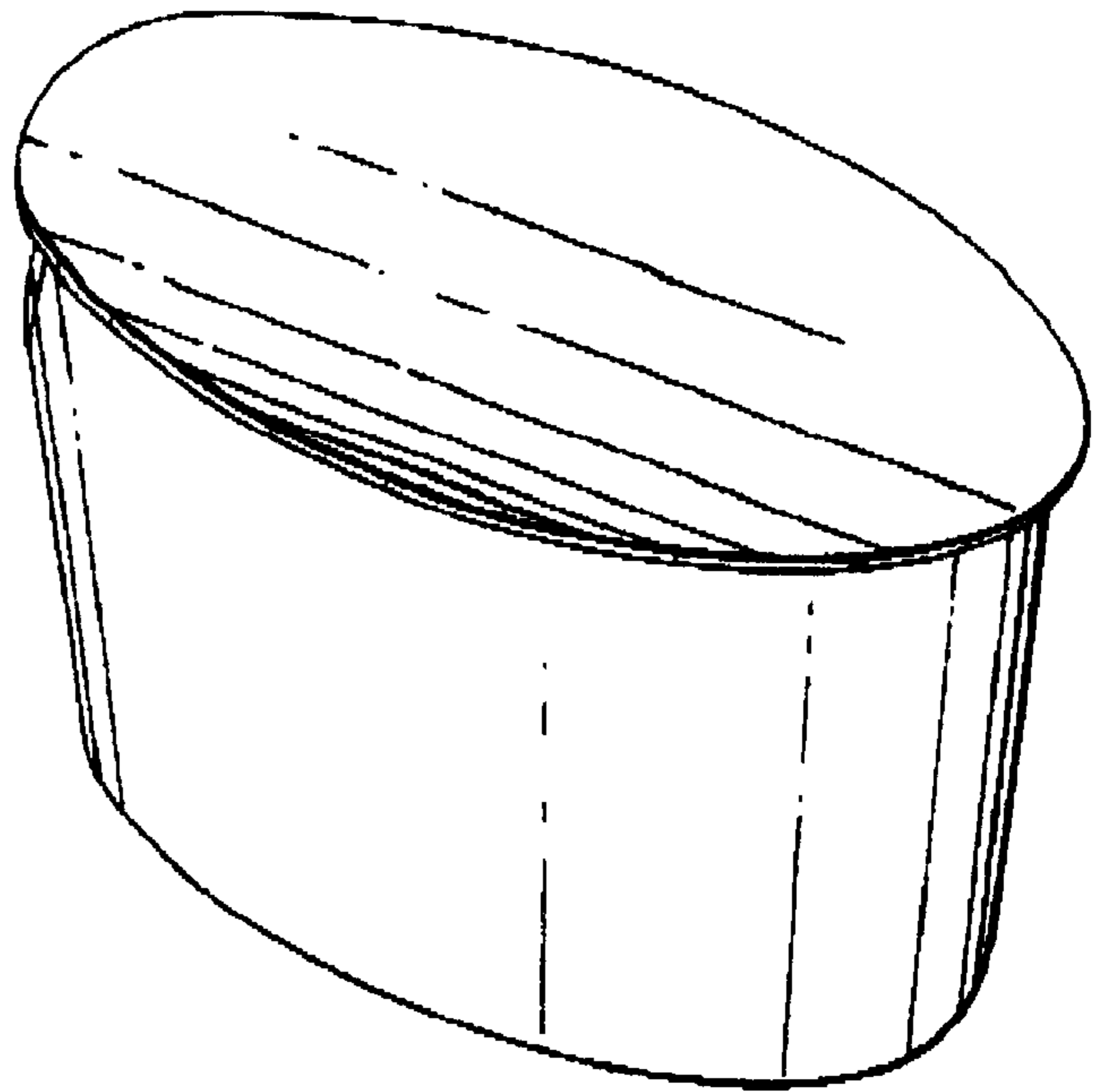

FIG. 16

FIG. 17

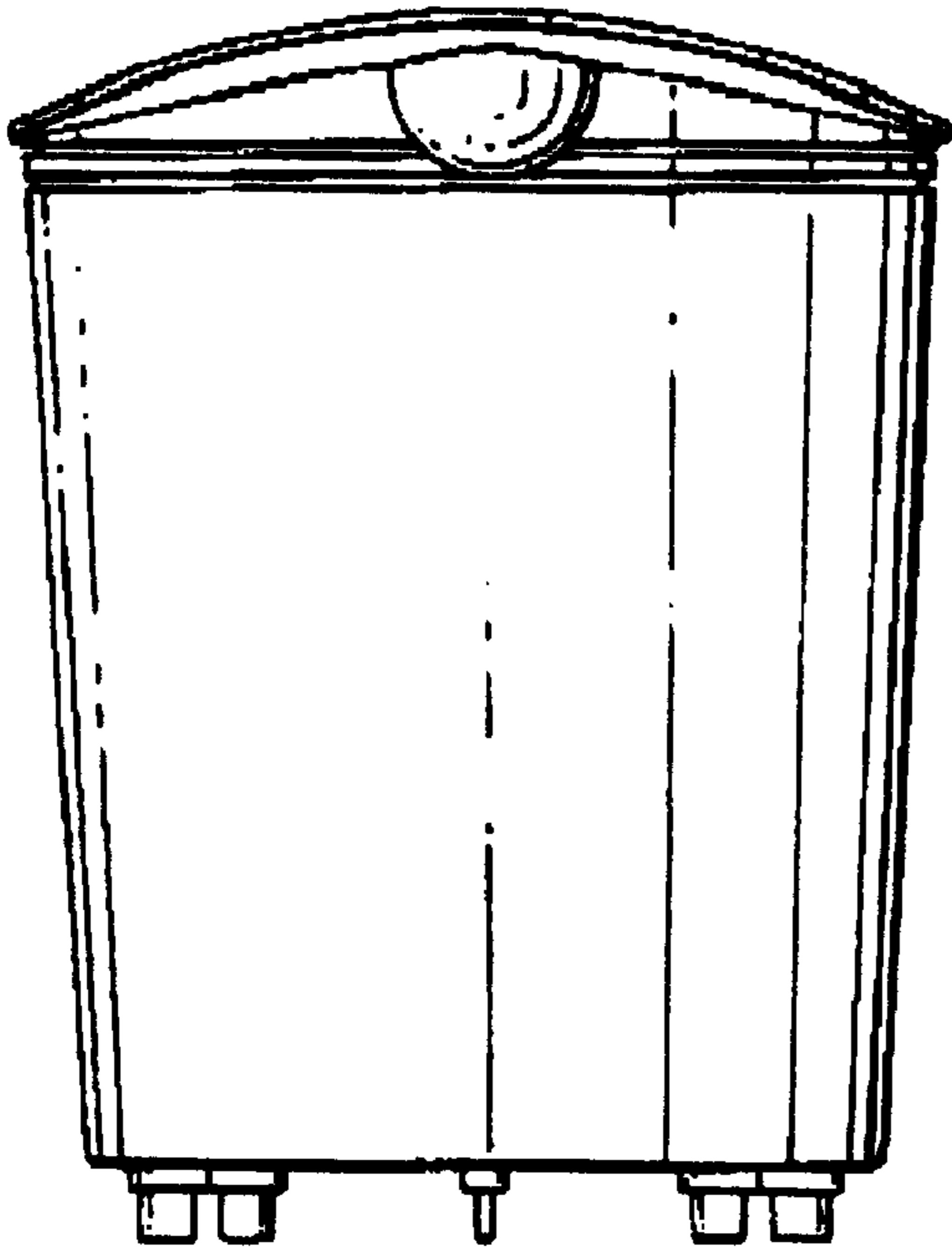

FIG. 18

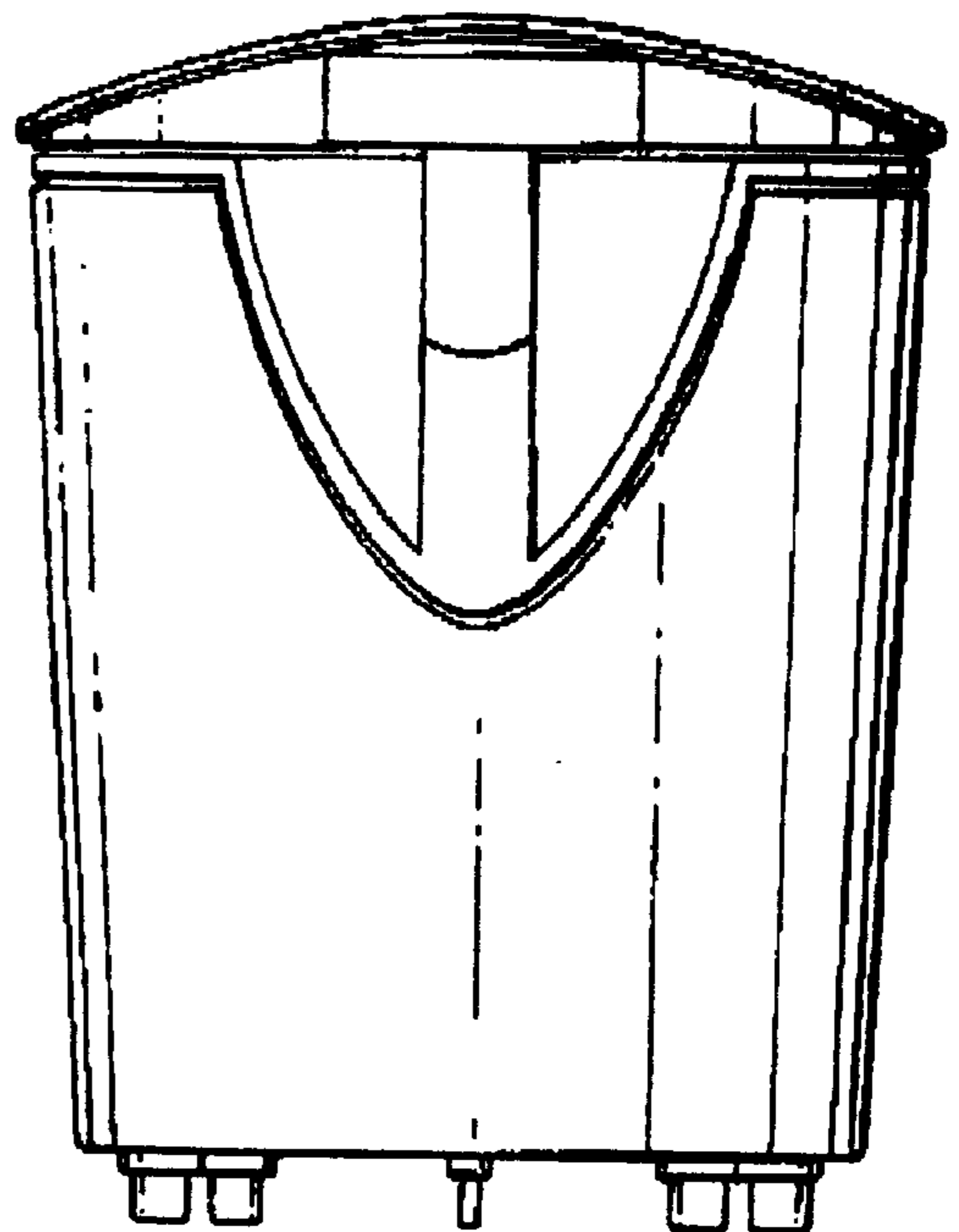

FIG. 19

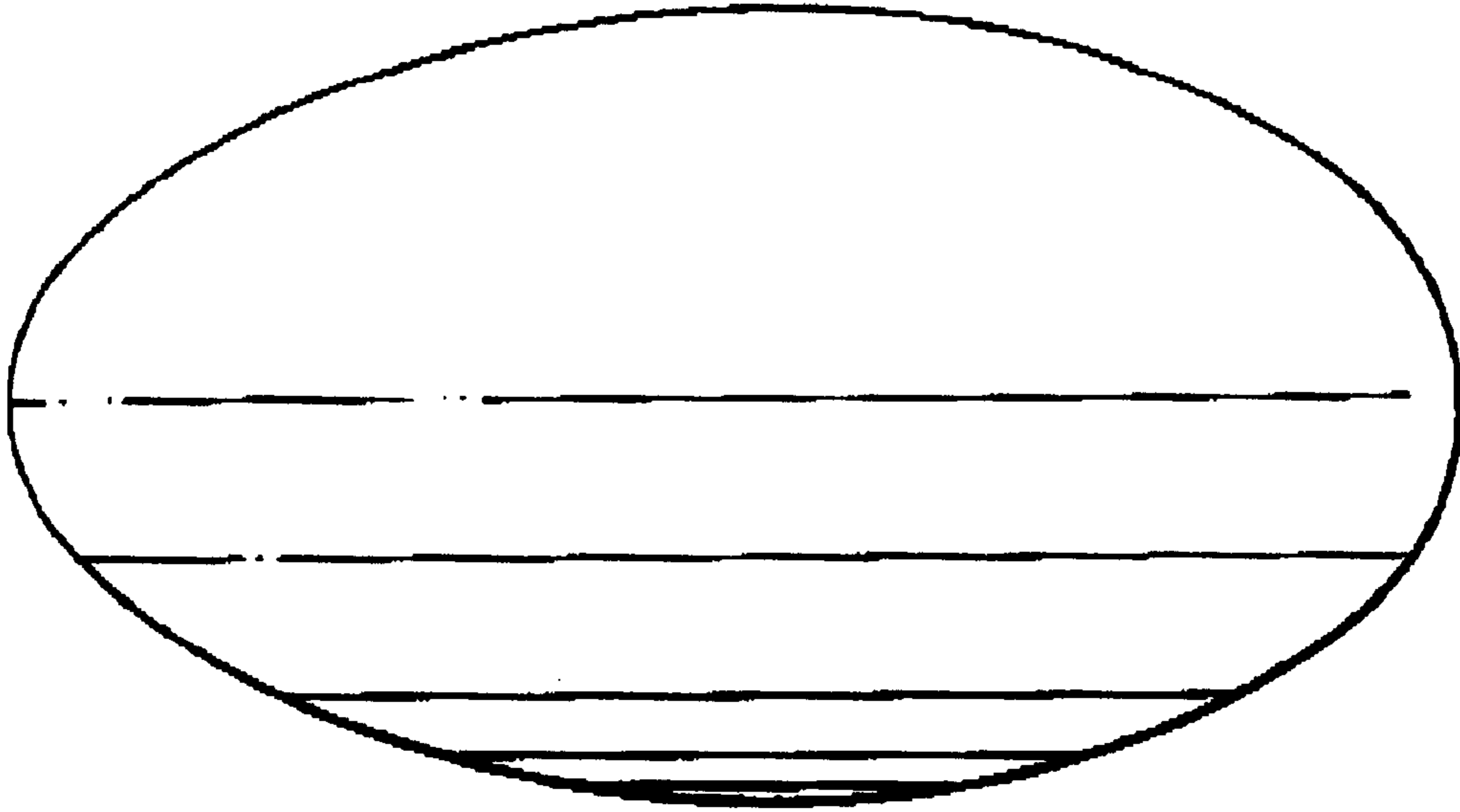

FIG. 20

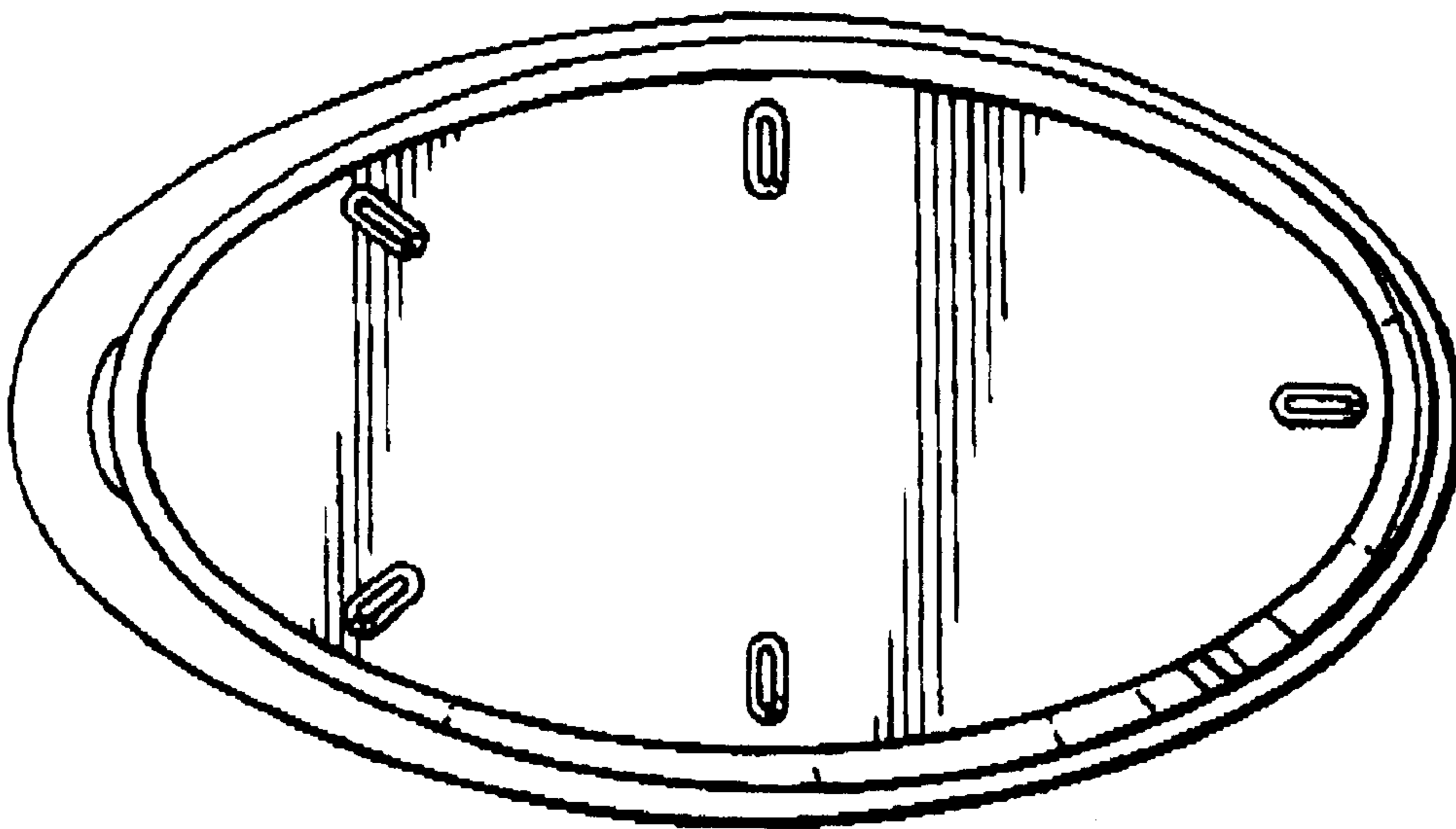

FIG. 21

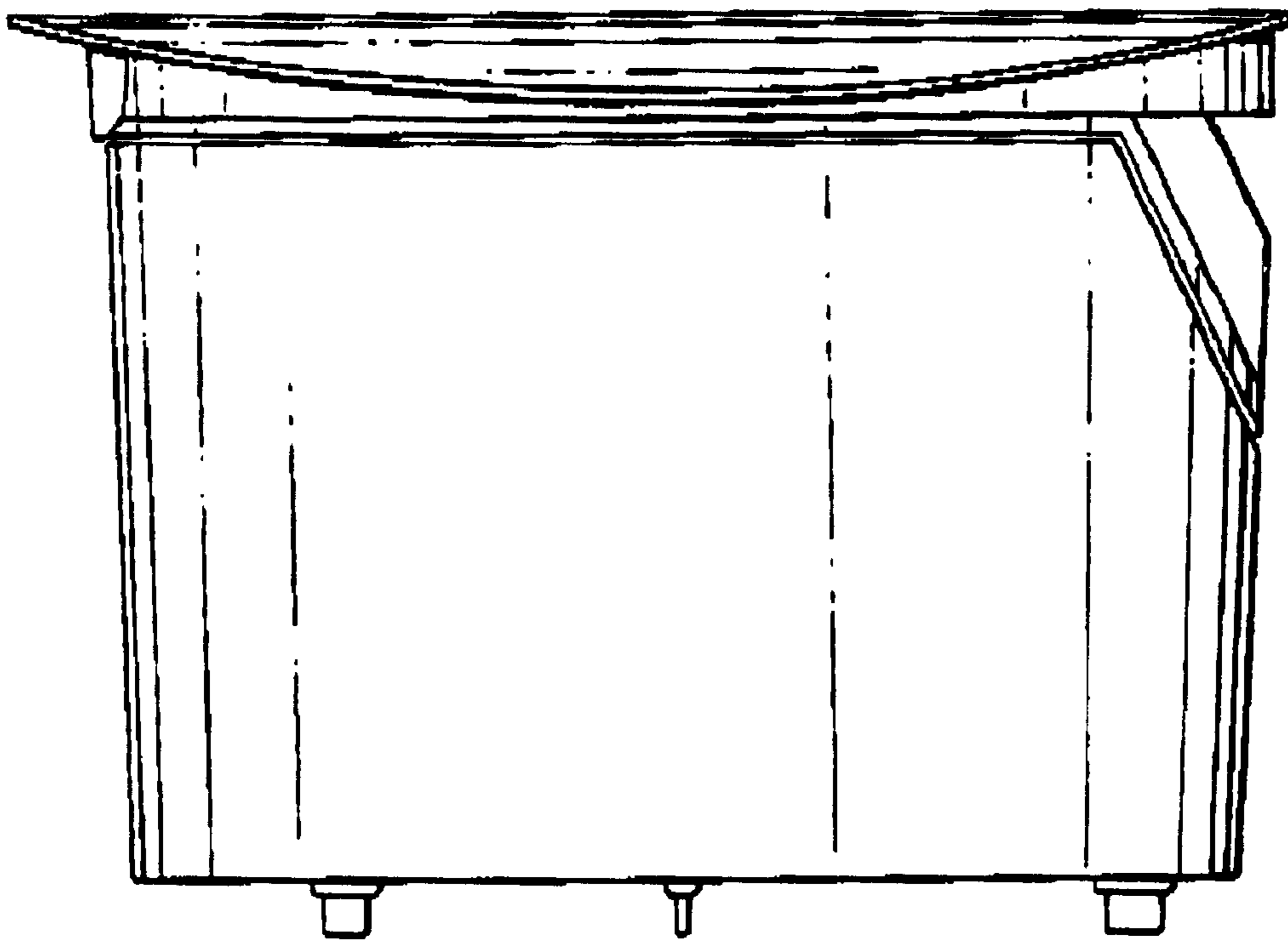

FIG. 22

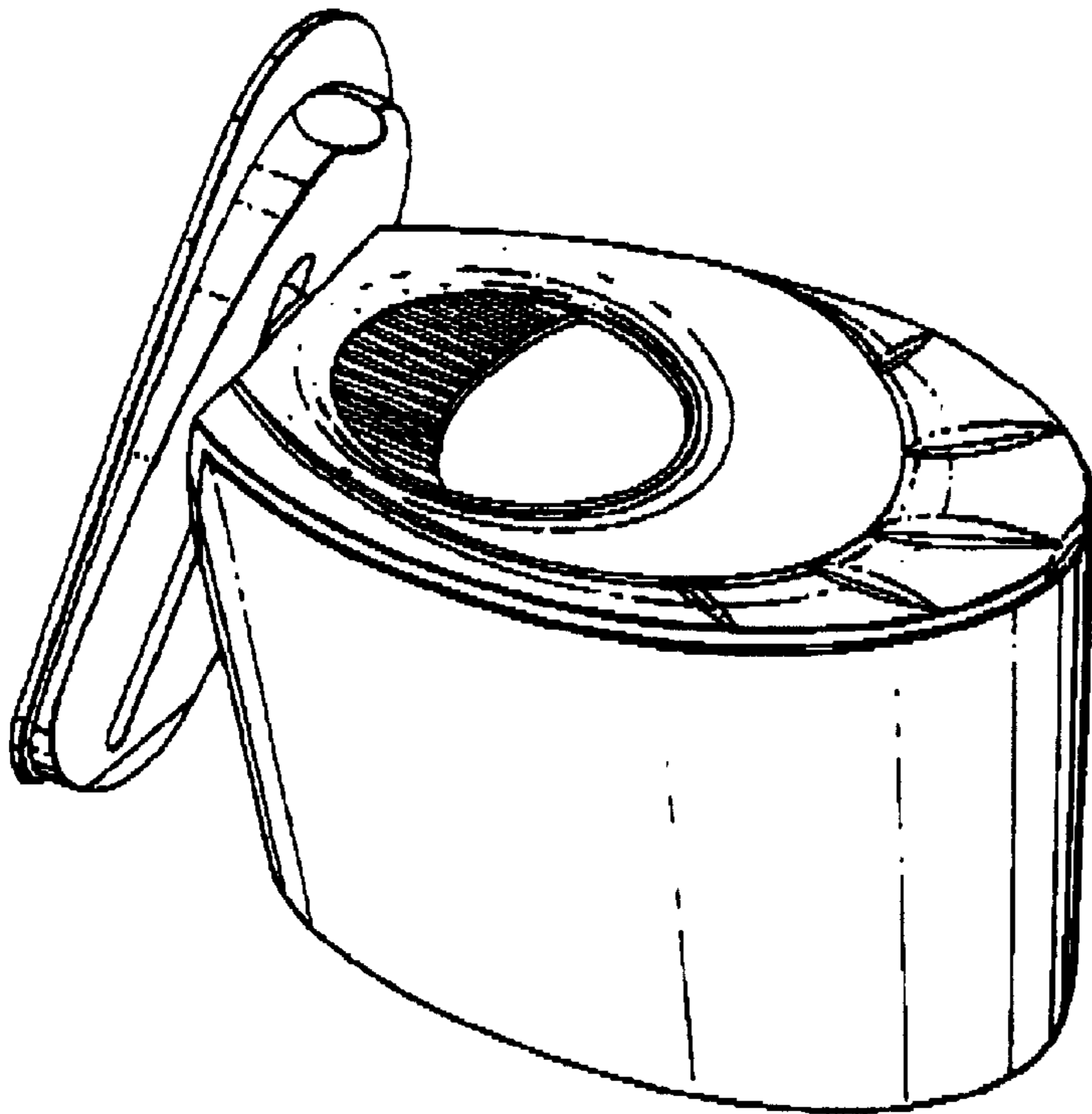
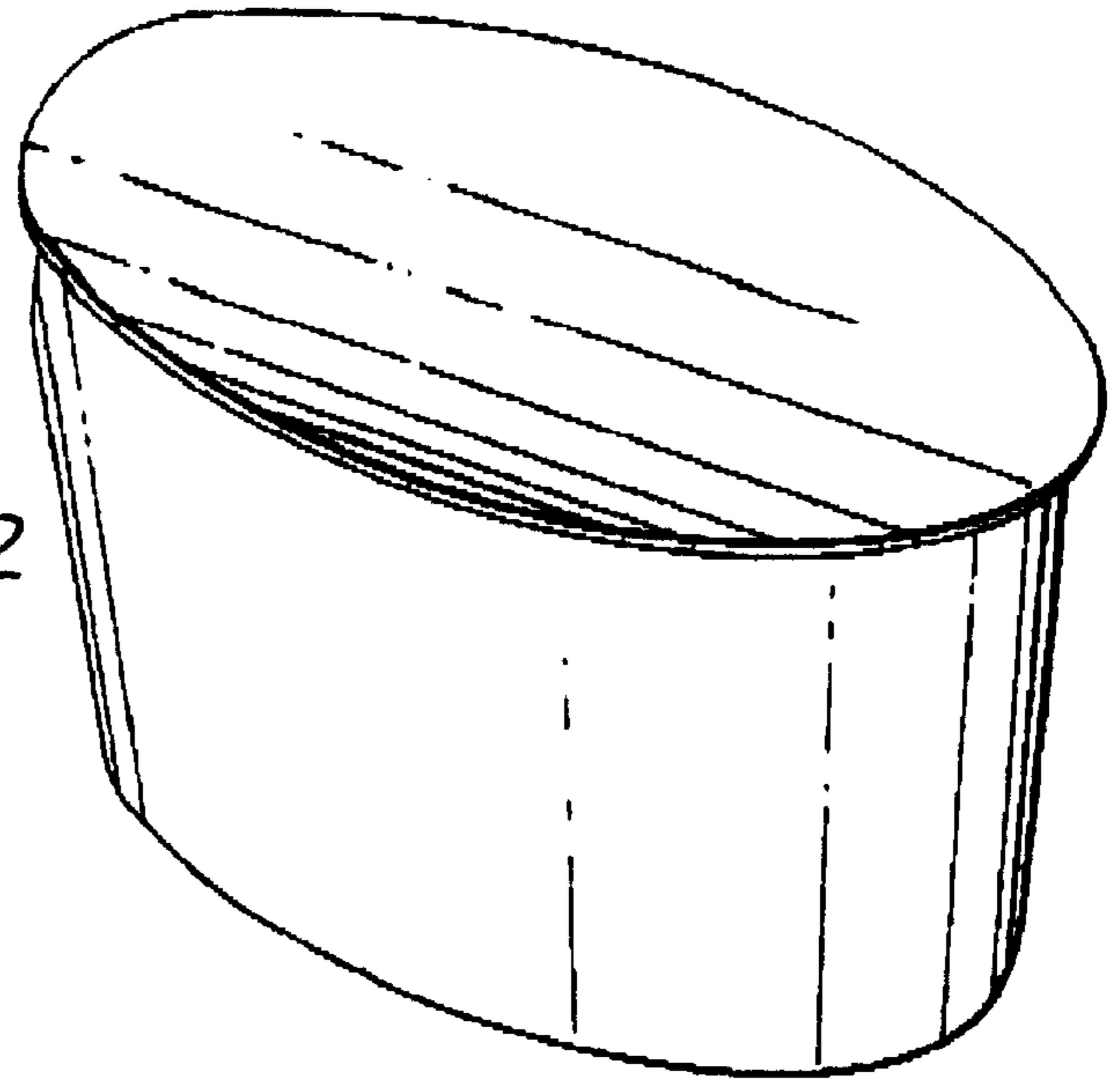

FIG. 23

FIG. 24

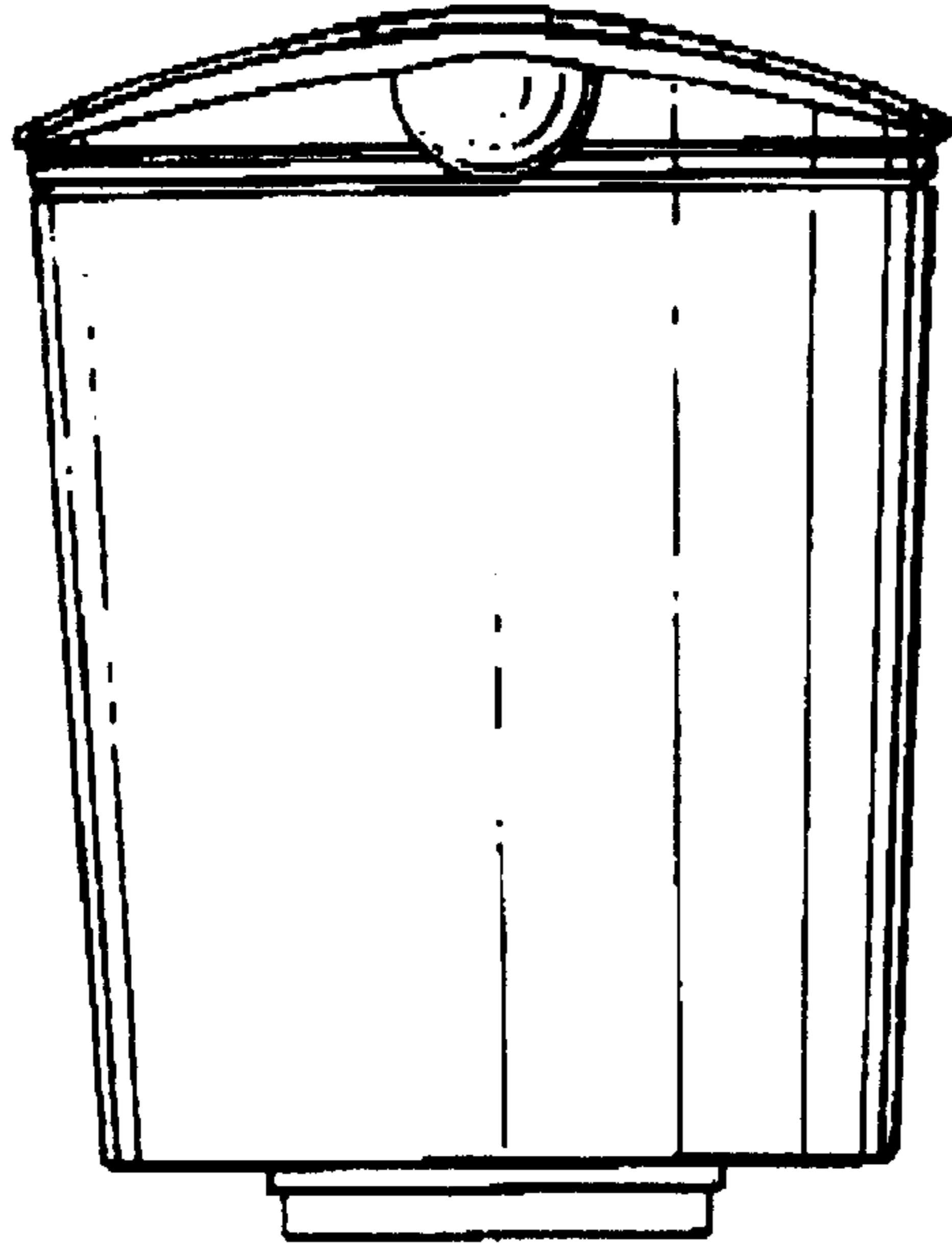

FIG. 25

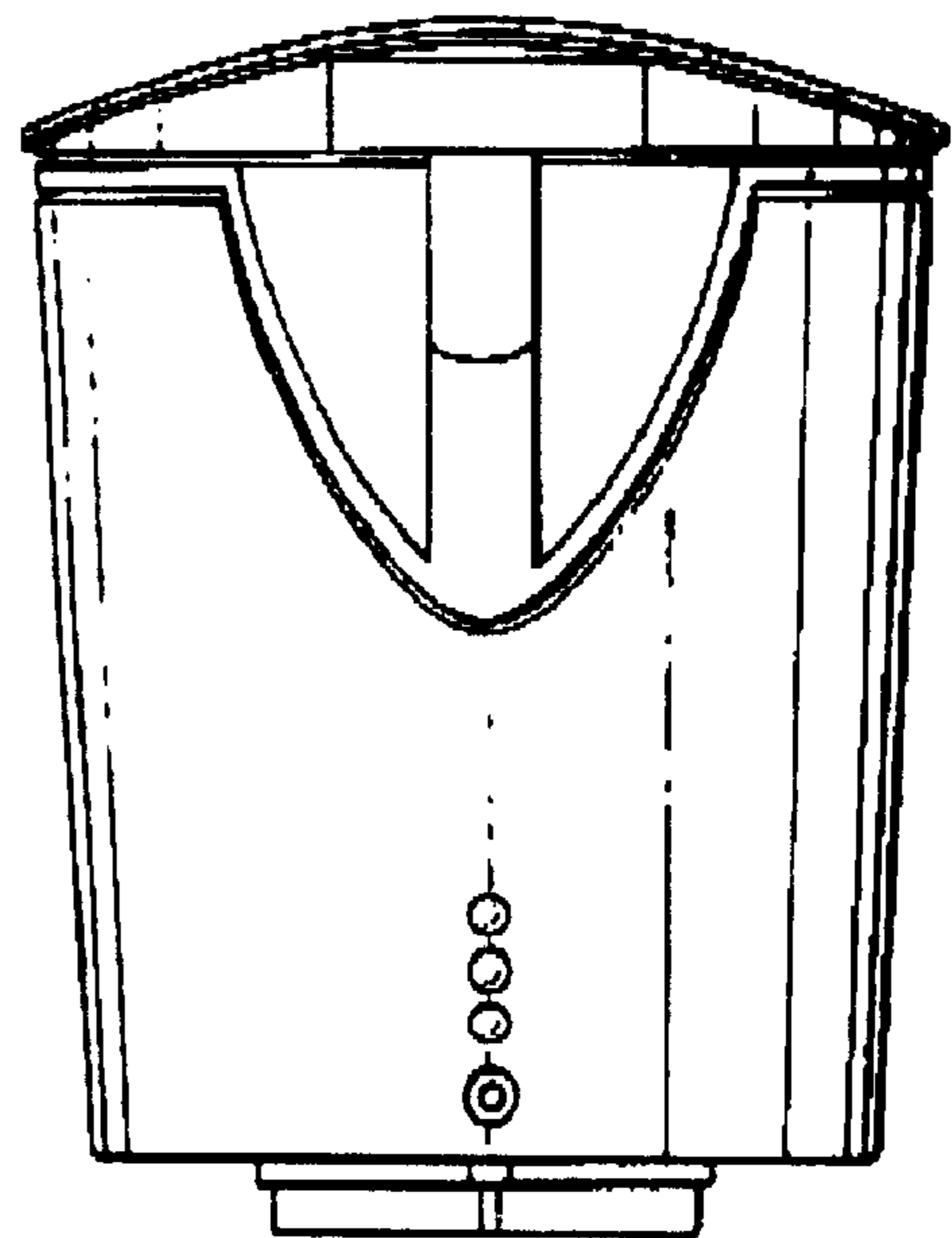



FIG. 26

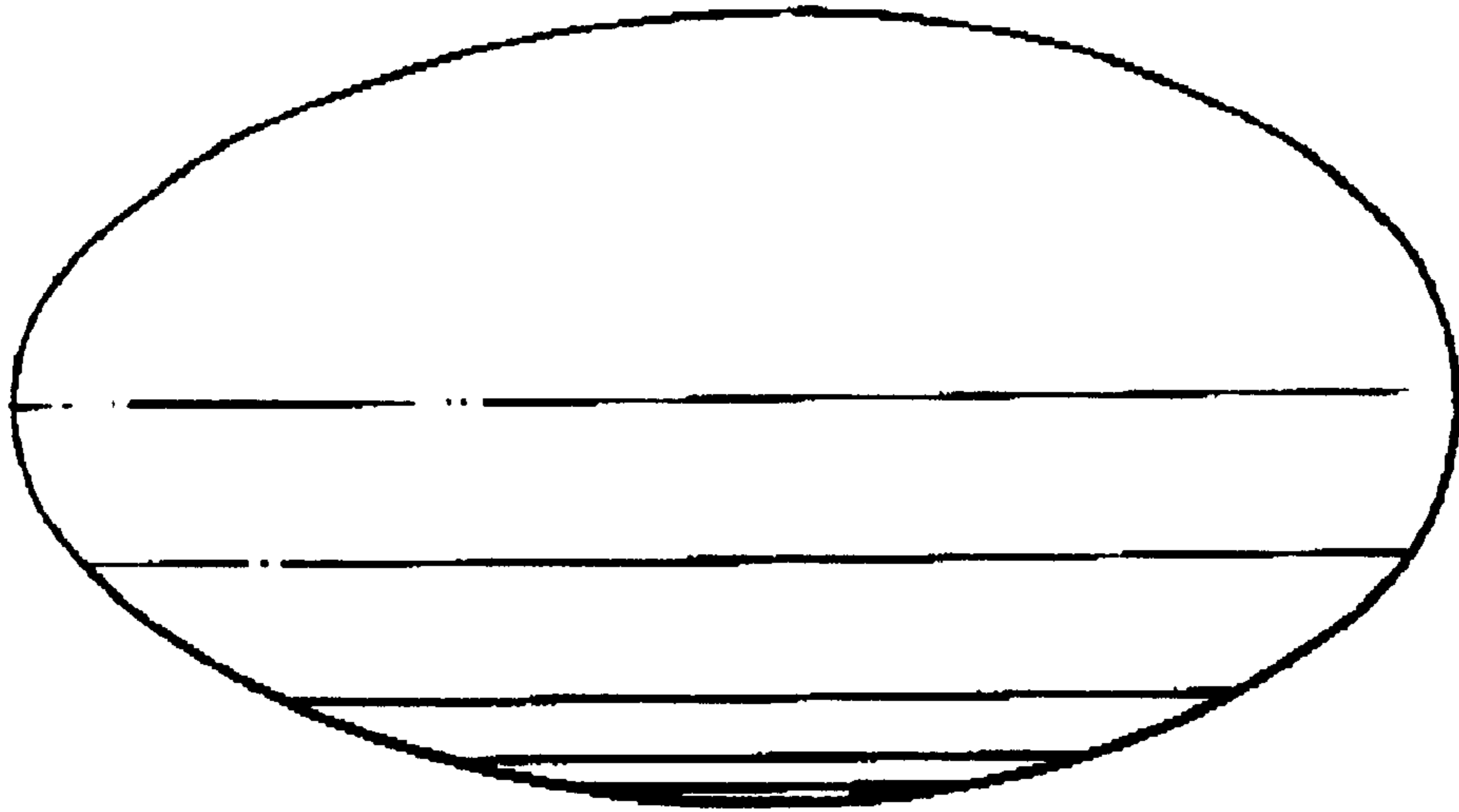

FIG. 27

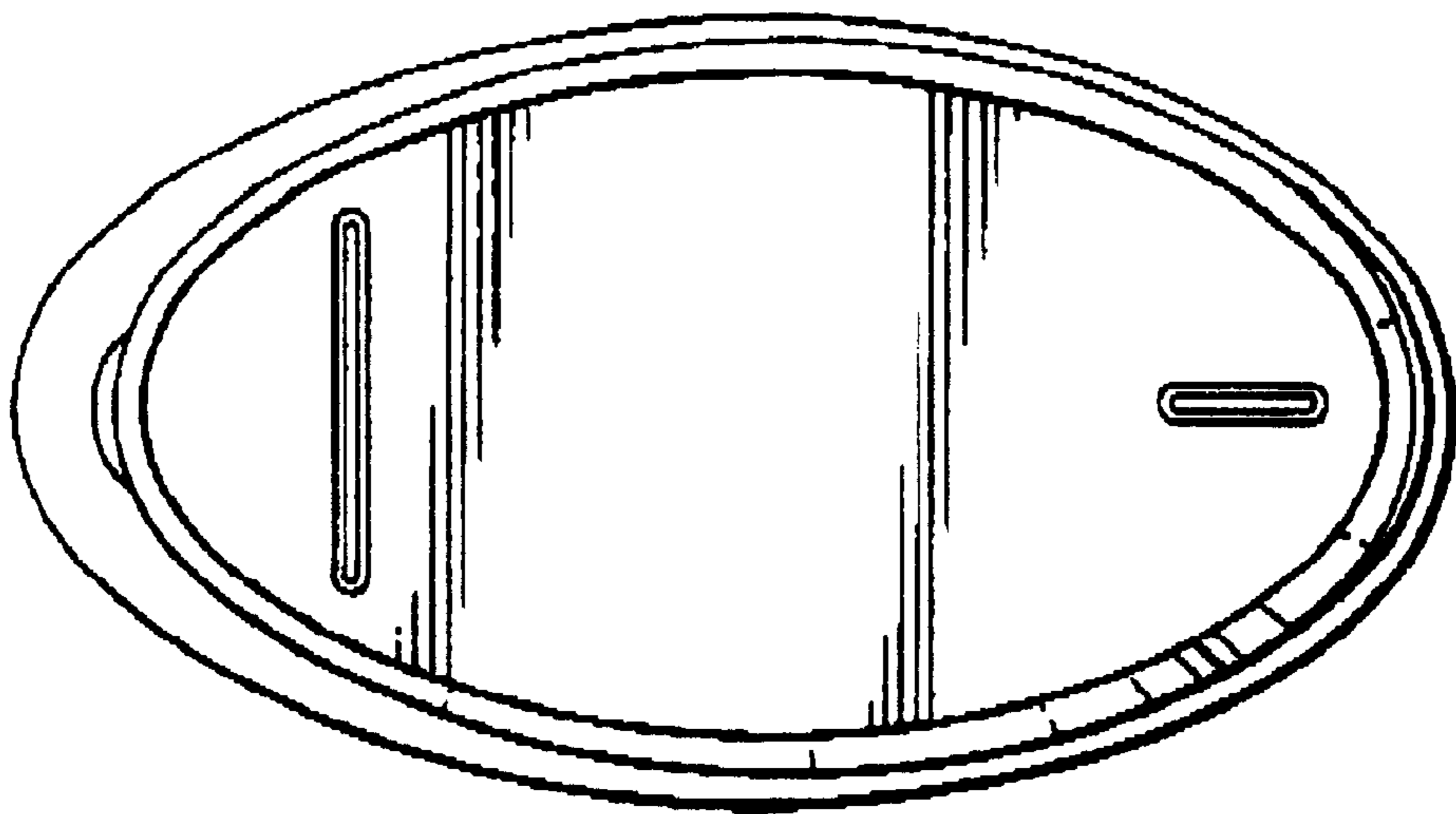

FIG. 28

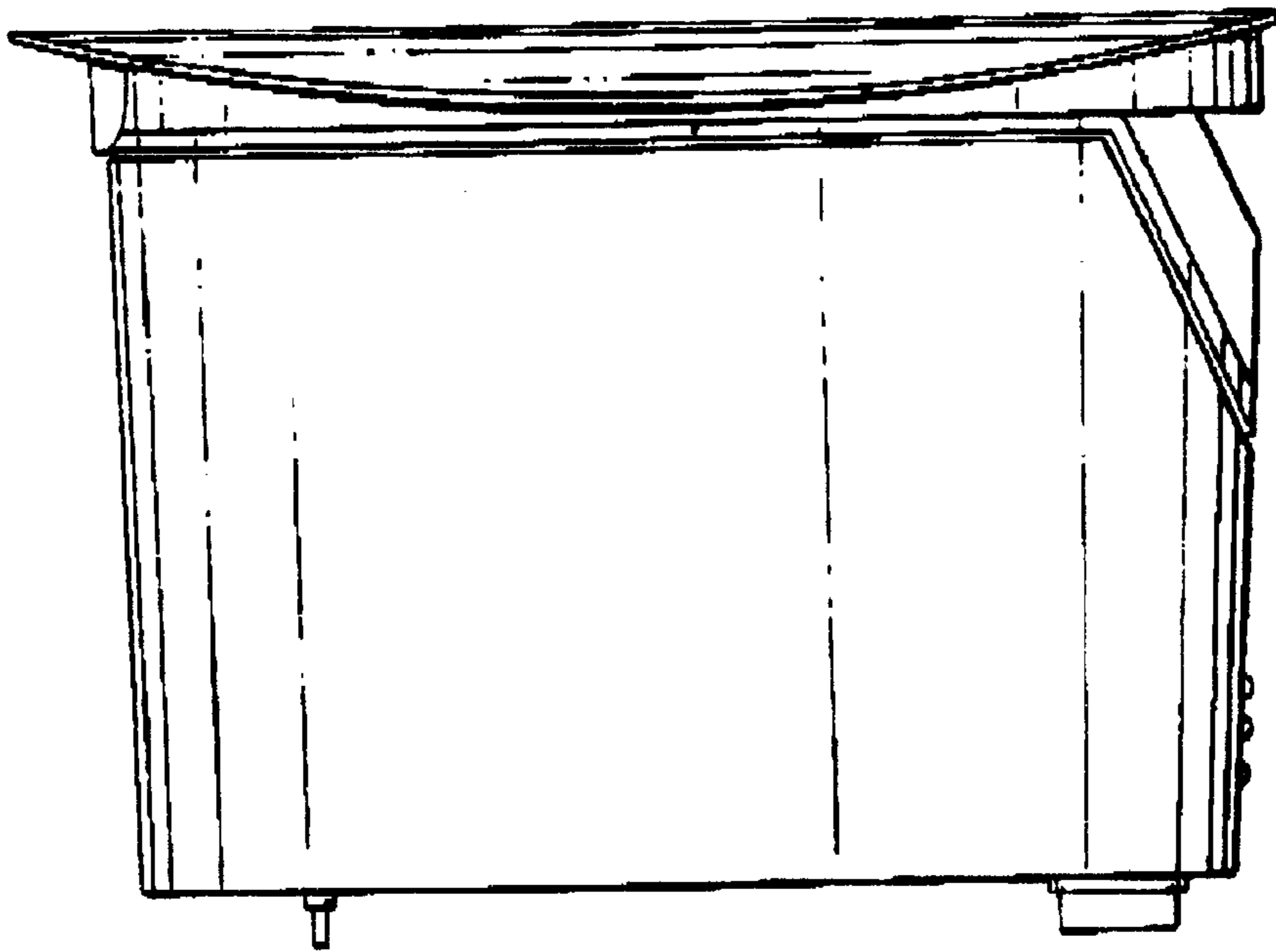

FIG. 29

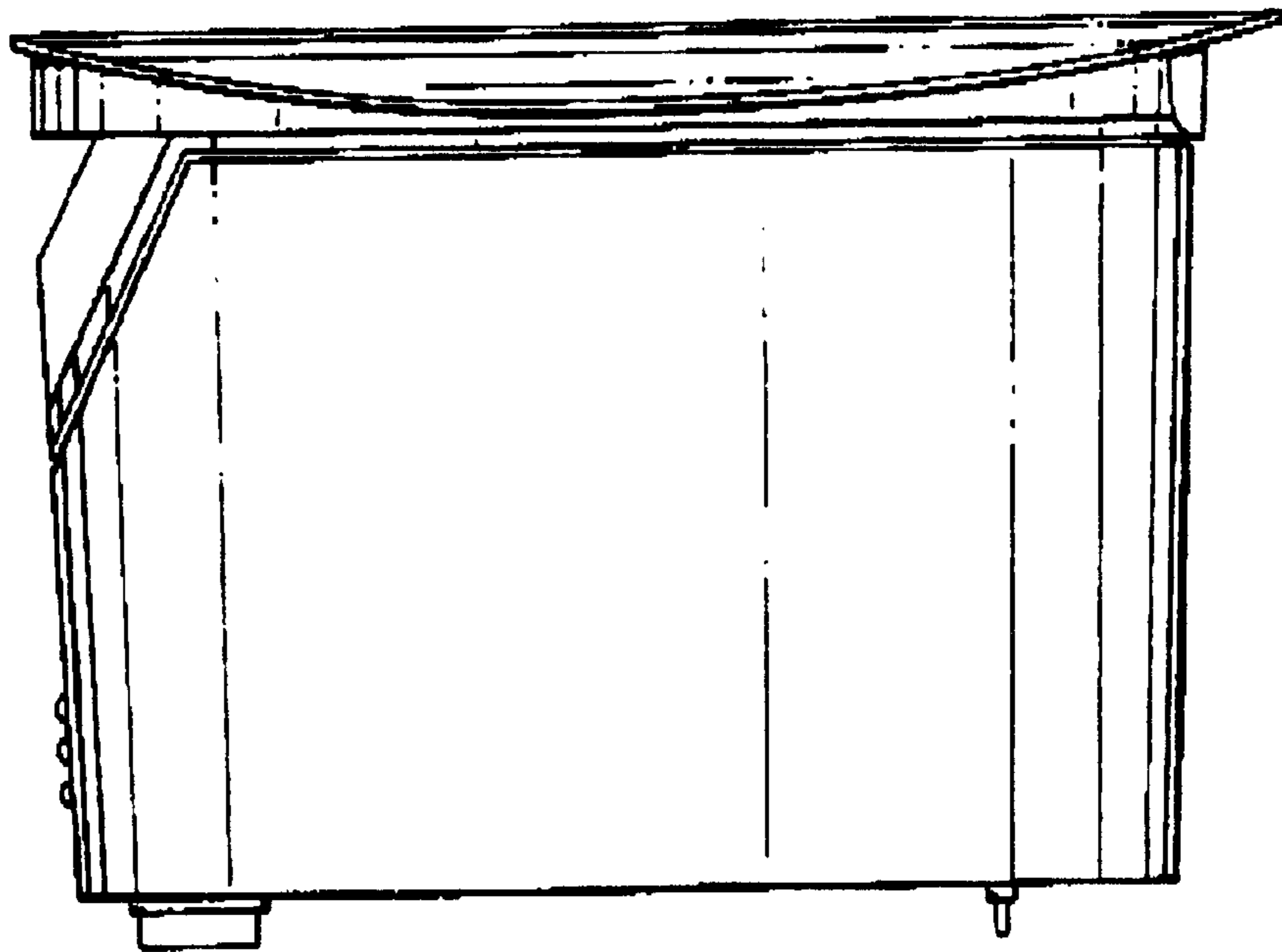

FIG. 30

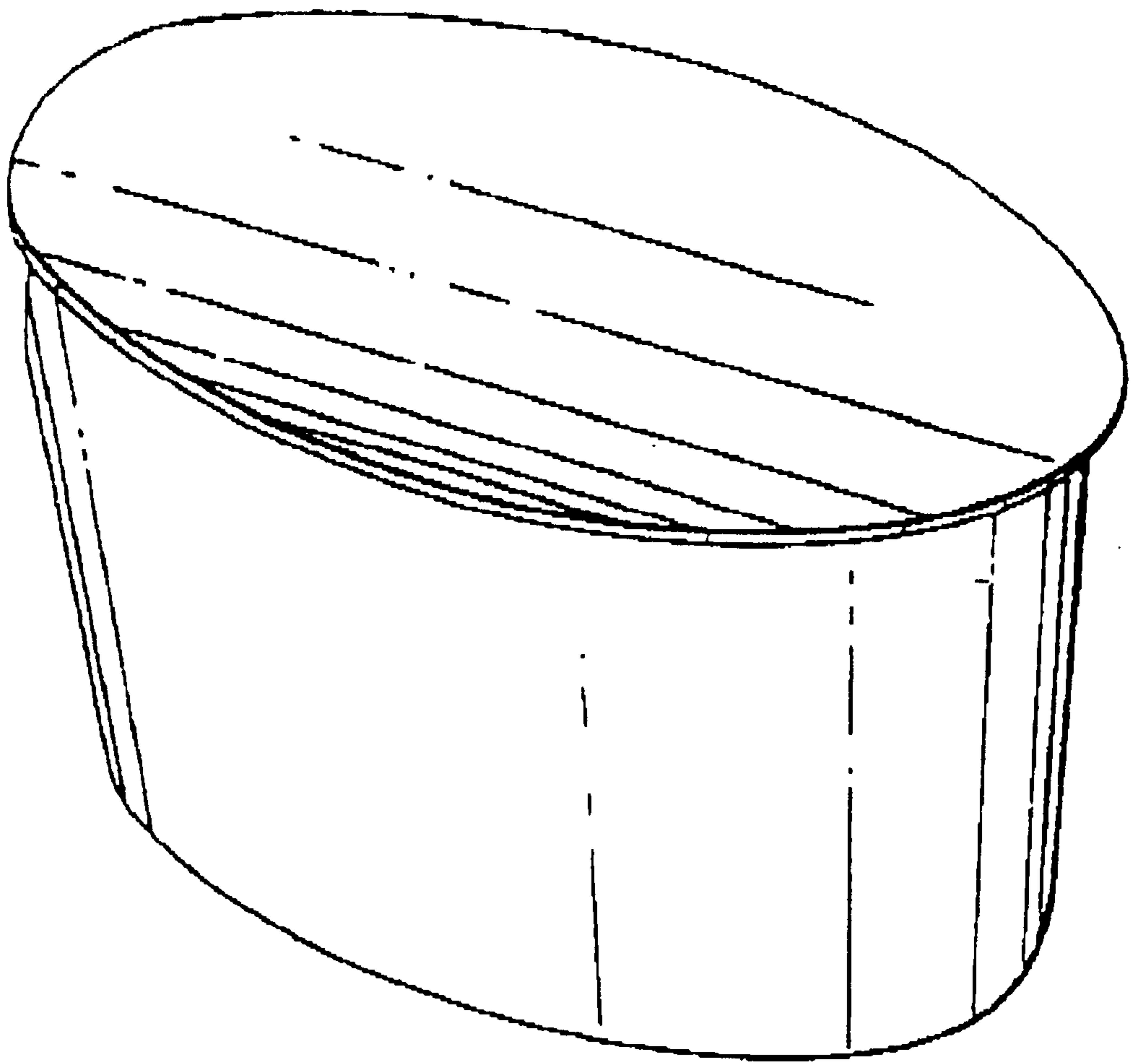

FIG. 31

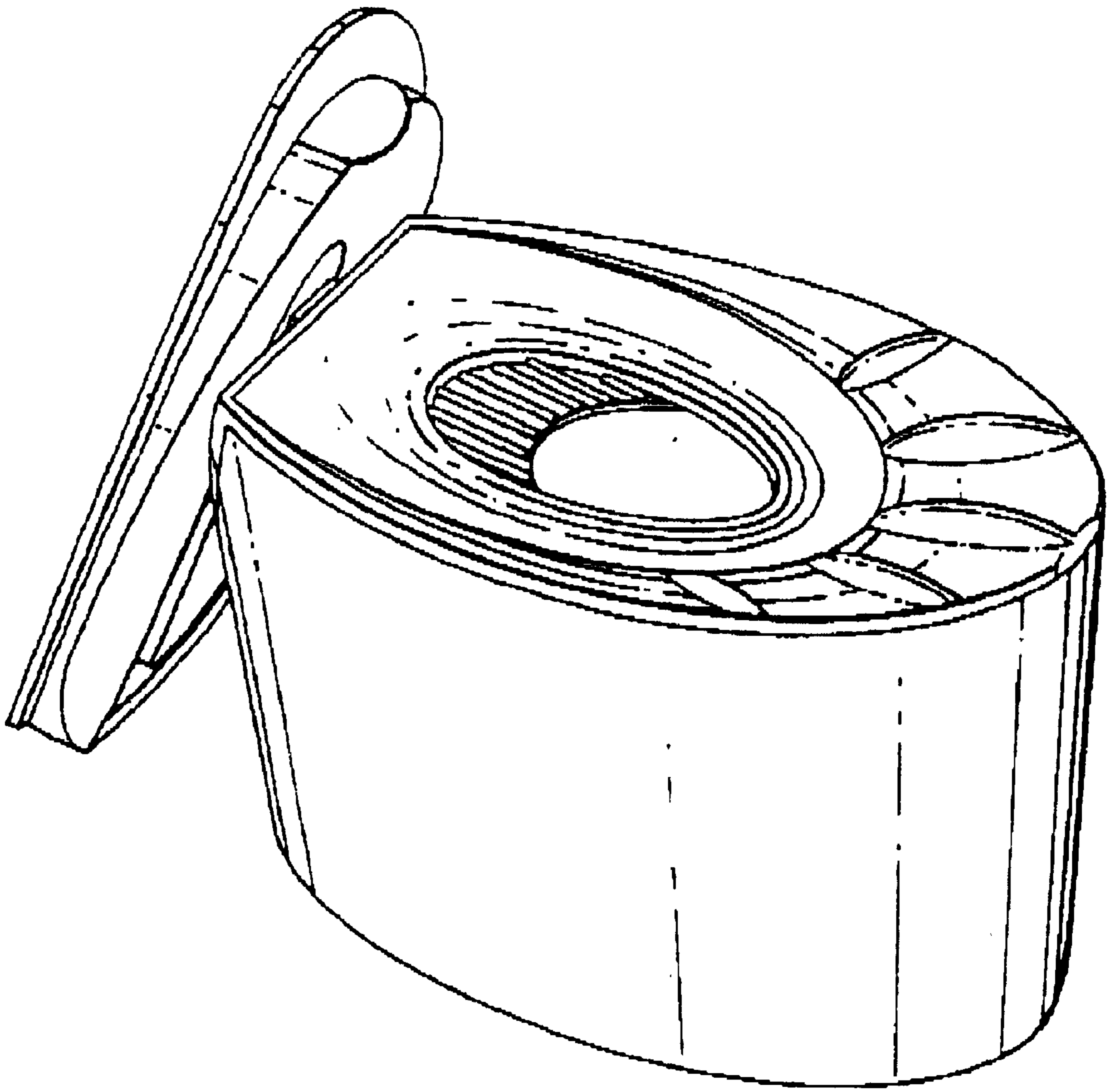

FIG. 32

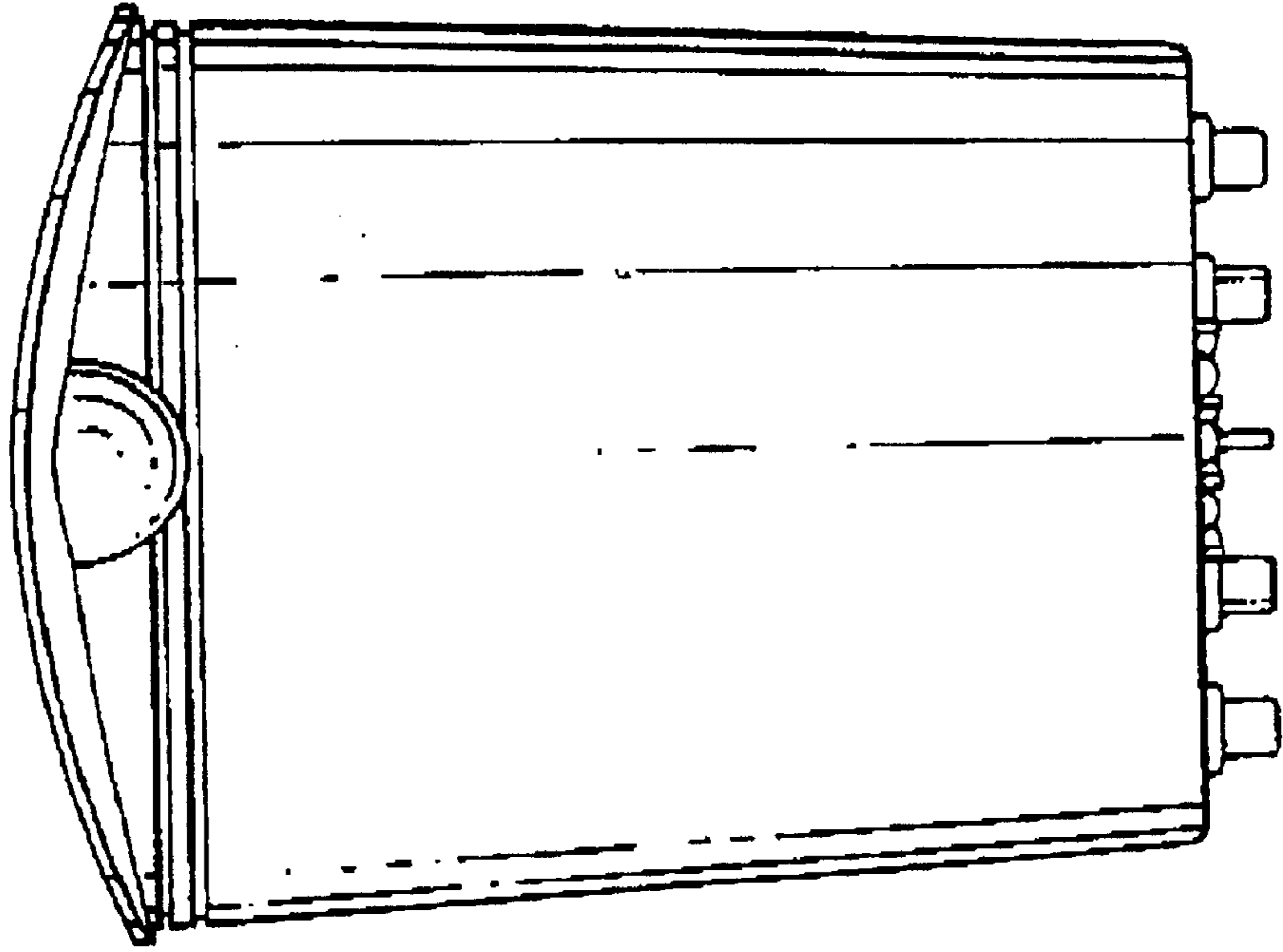

FIG. 33

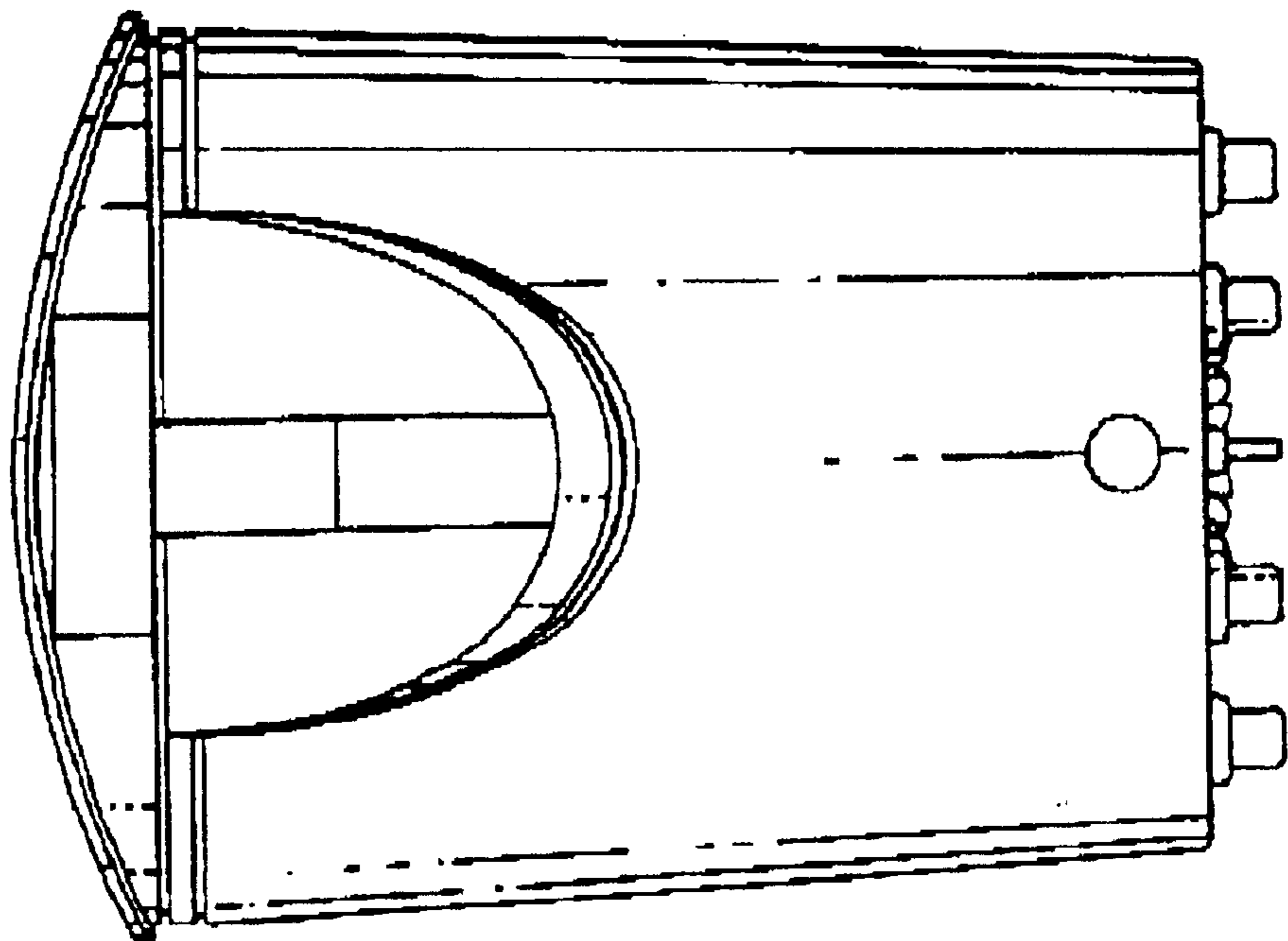

FIG. 36

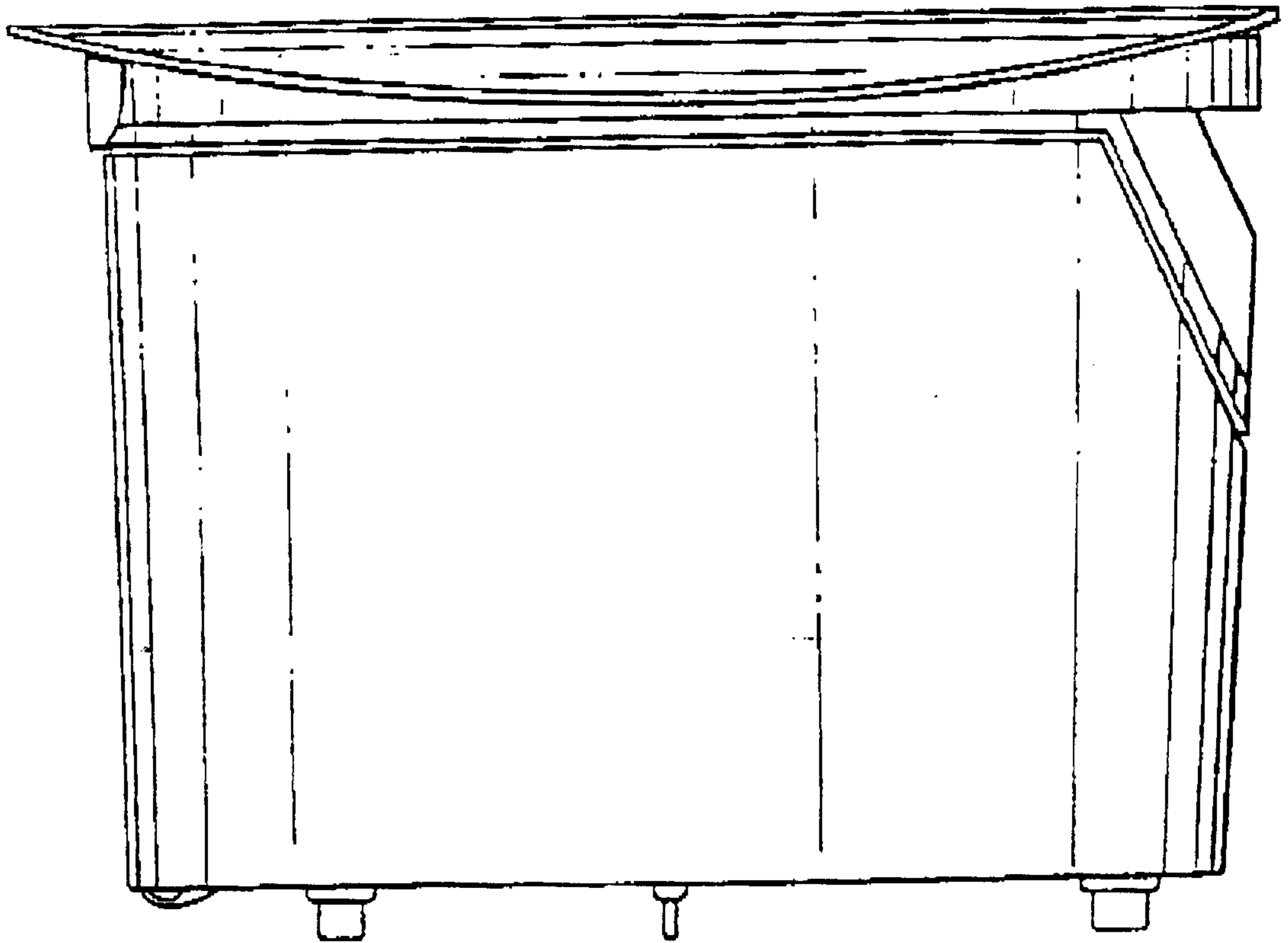

FIG. 34

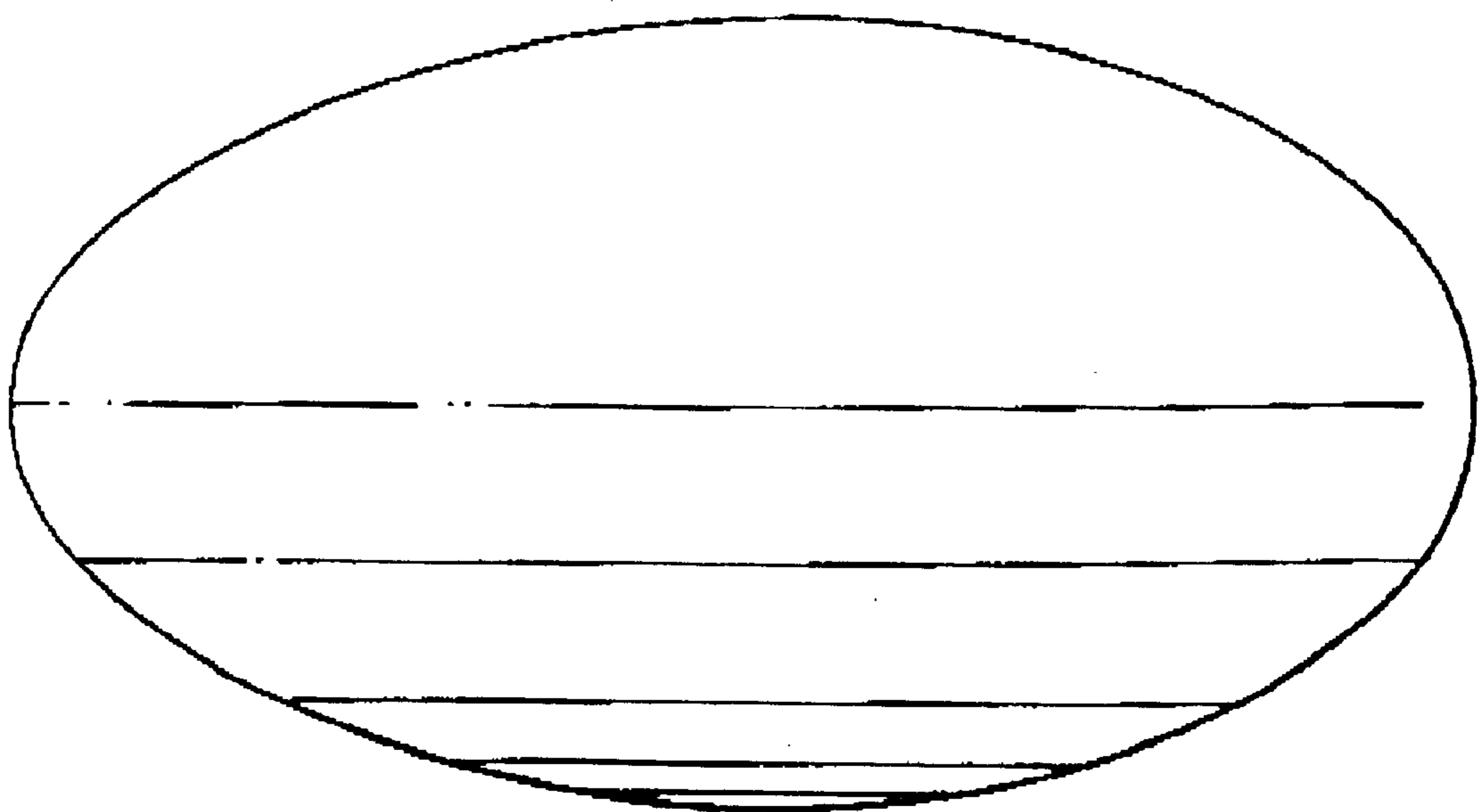

FIG. 35

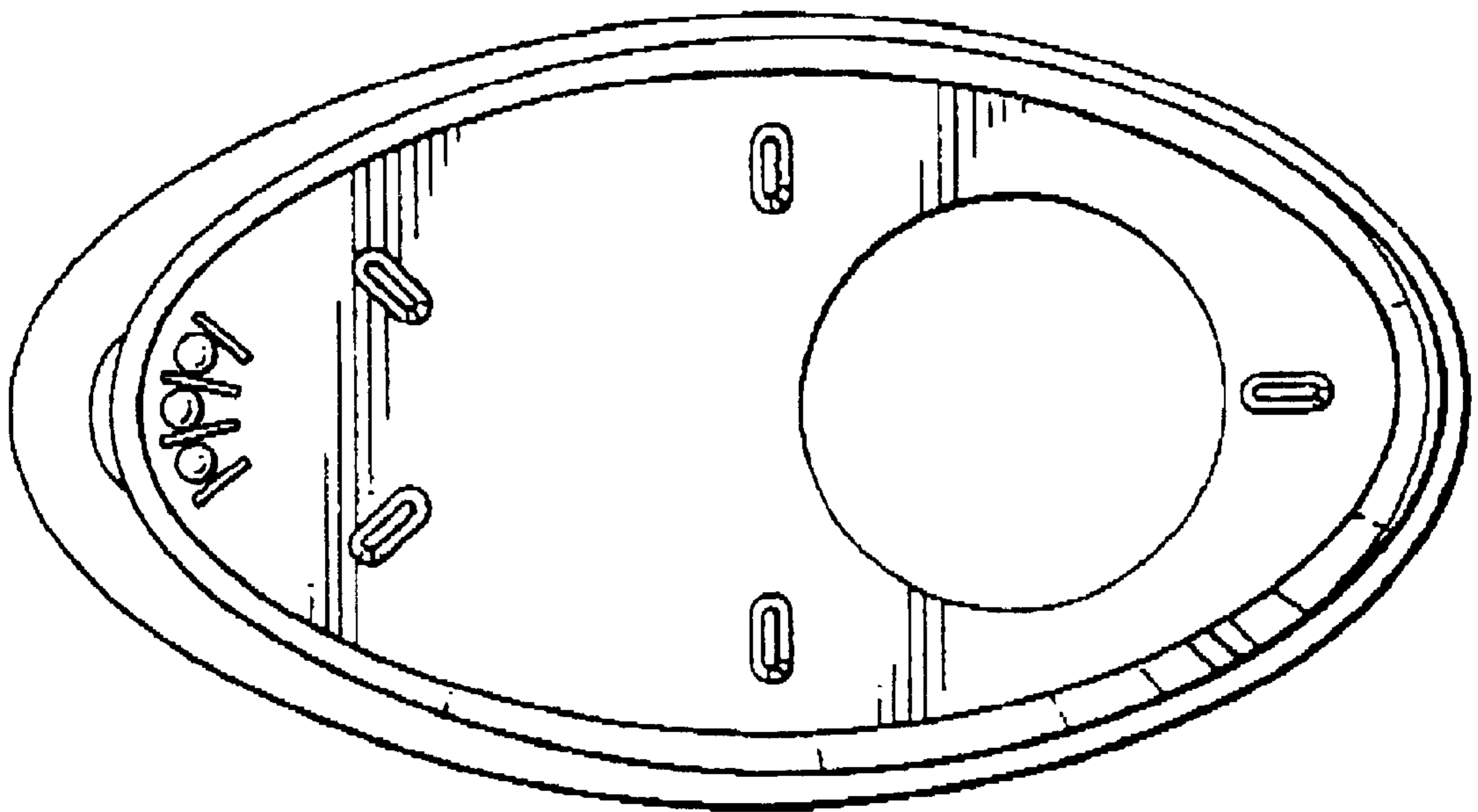

FIG. 37

