



US00D454513S

(12) **United States Design Patent**
Gueit

(10) **Patent No.:** **US D454,513 S**

(45) **Date of Patent:** **** Mar. 19, 2002**

(54) **RING**
(75) Inventor: **Jean-Claude Gueit, Perly (CH)**
(73) Assignee: **S.A. Ancienne Fabrique Georges Piaget & Cie, La Cote-aux-Fees (CH)**
(**) Term: **14 Years**

D124,825 S * 1/1941 Vogel D11/39
D136,698 S * 11/1943 Sacks D11/38
D146,017 S * 12/1946 Cook D11/38
D271,187 S * 11/1983 Bulgari D11/3
D424,965 S * 5/2000 Gueit D11/26
D434,994 S * 12/2000 Ferreira D11/26
D435,475 S * 12/2000 Canty D11/26

* cited by examiner

(21) Appl. No.: **29/134,376**
(22) Filed: **Dec. 21, 2000**

Primary Examiner—Cathy Anne MacCormac
(74) *Attorney, Agent, or Firm*—Young & Thompson

Related U.S. Application Data

(62) Division of application No. 29/101,269, filed on Mar. 1, 1999.

(57) **CLAIM**

The ornamental design for a ring, as shown and described.

(30) **Foreign Application Priority Data**

Sep. 22, 1998 (XH) DMA/004 234

DESCRIPTION

(51) **LOC (7) Cl.** **11-01**
(52) **U.S. Cl.** **D11/26**
(58) **Field of Search** D11/26-39, 3,
D11/4; 63/15, 15.1, 15.2, 15.3, 15.4, 15.45,
15.5, 15.6, 15.65, 15.7, 15.8, 15.9, 26-28,
3

FIG. 1 is a perspective view of a first embodiment of a ring having a body and a rotatable central ring, showing my new design;
FIG. 2 is another perspective view thereof, the central ring being in a different position;
FIG. 3 is a top plan view of FIG. 1;
FIG. 4 is a top plan view of FIG. 2;
FIG. 5 is a side view of FIG. 3;
FIG. 6 is a side view of FIG. 4;
FIG. 7 is another side view of FIG. 3;
FIG. 8 is another side view of FIG. 4;
FIG. 9 is a perspective view of a second embodiment of FIG. 1;
FIG. 10 is another perspective view of FIG. 9, the central ring being in a different position;
FIG. 11 is a top plan view of FIG. 9;
FIG. 12 is a top plan view of FIG. 10;
FIG. 13 is a side view of FIG. 11;
FIG. 14 is a side view of FIG. 12;
FIG. 15 is another side view of FIG. 11; and,
FIG. 16 is another side view of FIG. 12.
The broken lines are for illustrative purposes only and form no part of the claimed design.

(56) **References Cited**

U.S. PATENT DOCUMENTS

D12,868 S * 4/1882 Ripley D11/37
D52,014 S * 5/1918 Whitehouse D11/34
D56,388 S * 10/1920 Sharp D11/38
D58,603 S * 8/1921 Lapidus D11/38
D59,236 S * 10/1921 Lapidus D11/39
D59,314 S * 10/1921 Winsen D11/38
D61,982 S * 2/1923 Lapidus D11/34
1,681,687 A * 8/1928 Schraysshuen 63/15.4
D99,681 S * 5/1936 Salter D11/37
D100,148 S * 6/1936 Barun D11/38
D100,754 S * 8/1936 Braun D11/38
2,086,493 A * 7/1937 Ellingwood 63/3

1 Claim, 6 Drawing Sheets

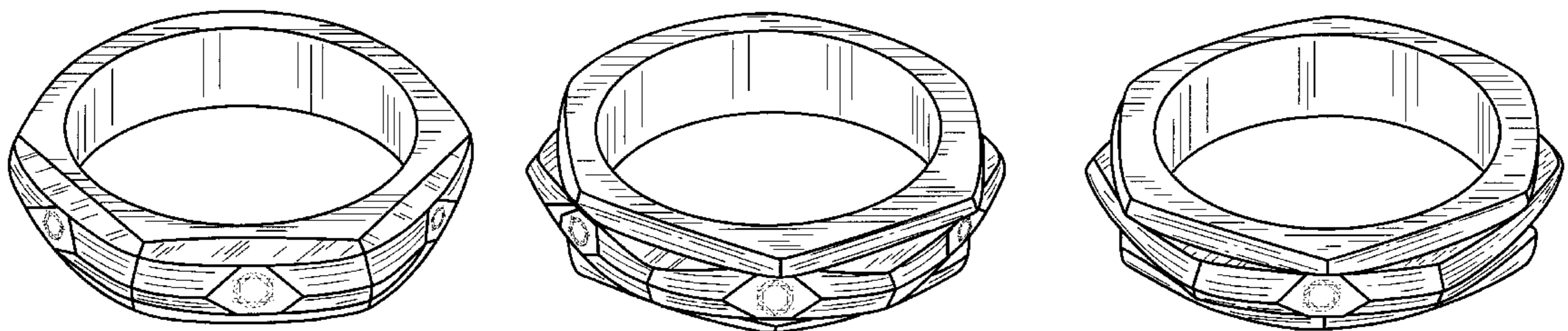

Fig. 1

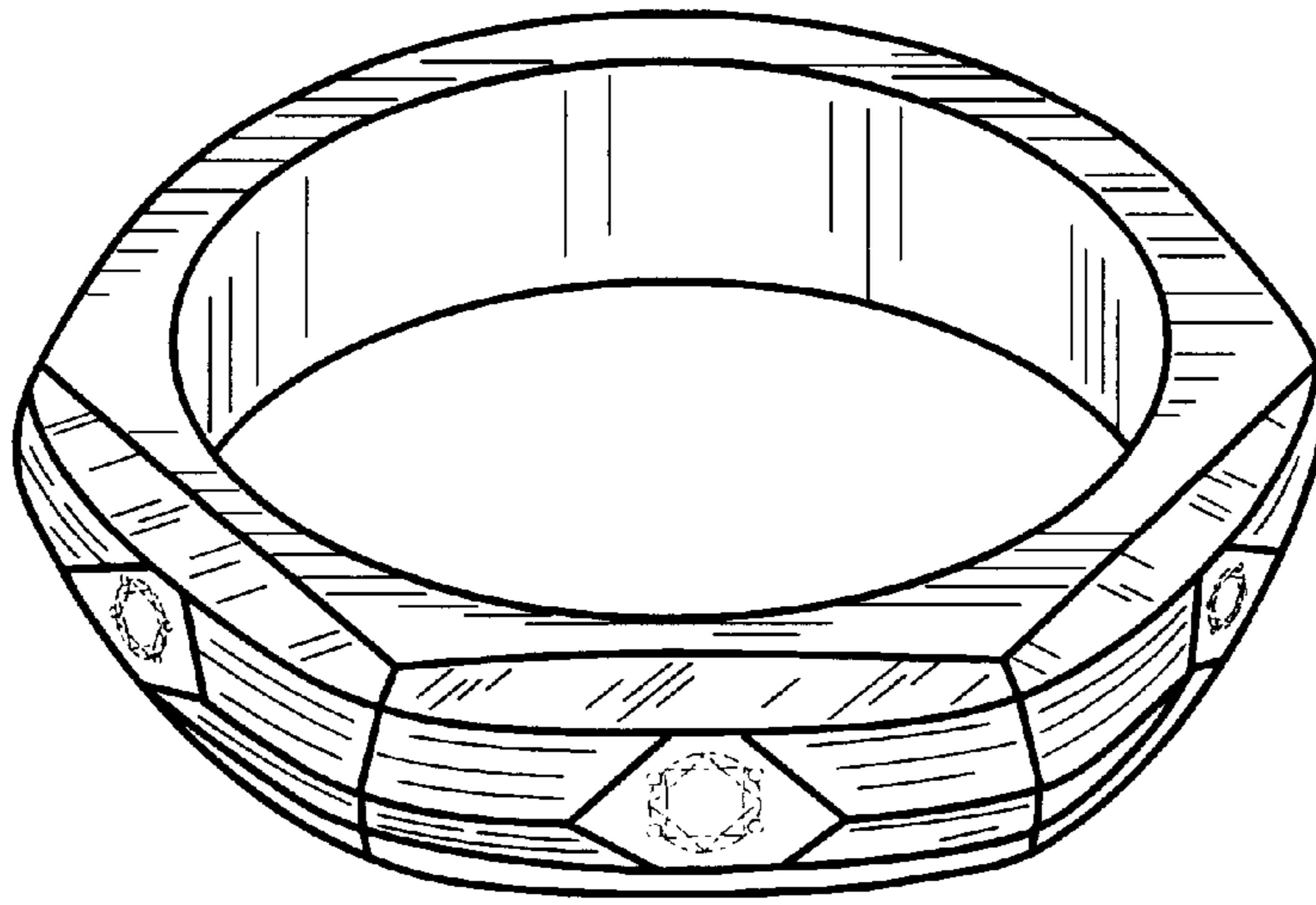

Fig. 3

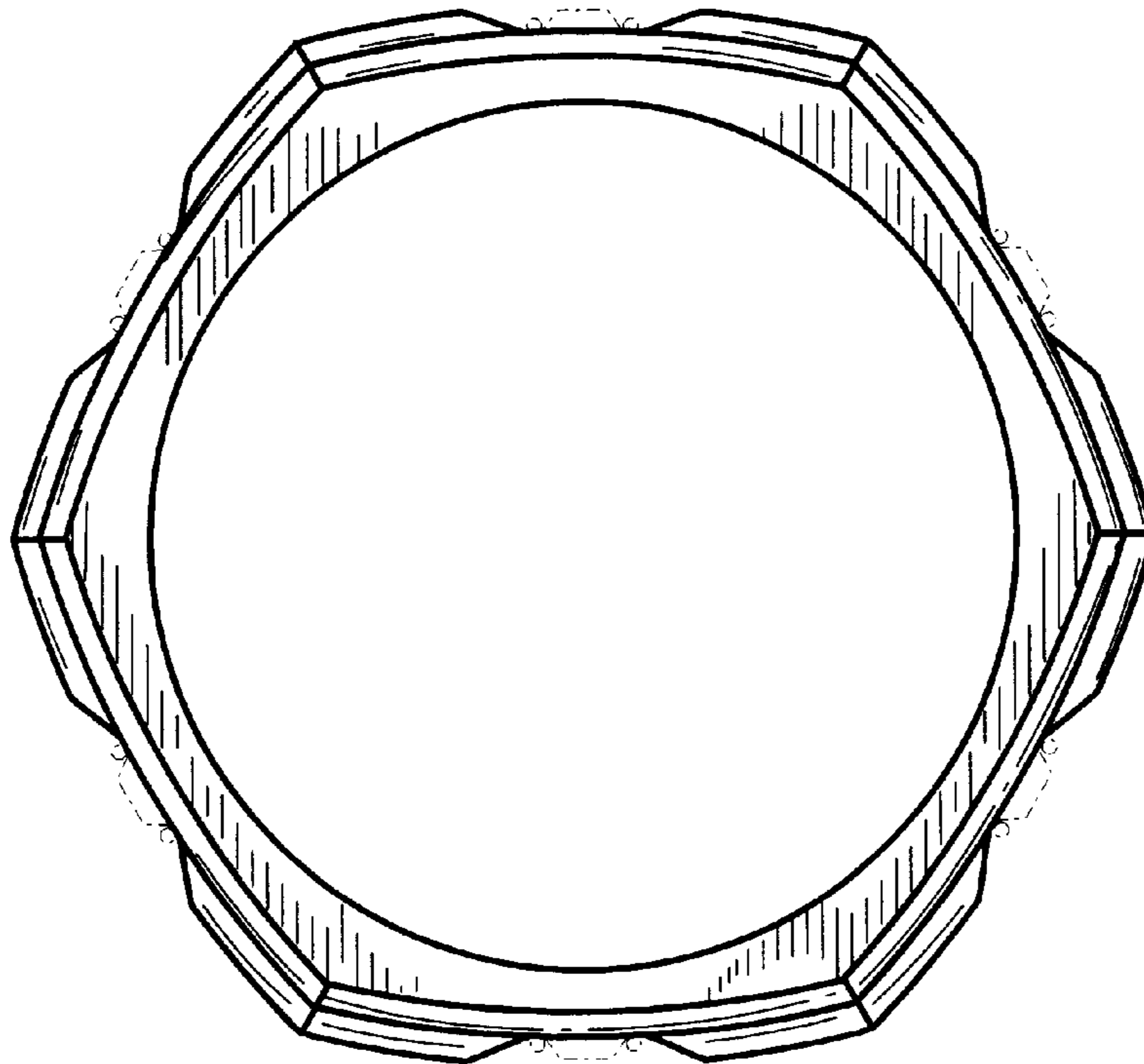

Fig. 2

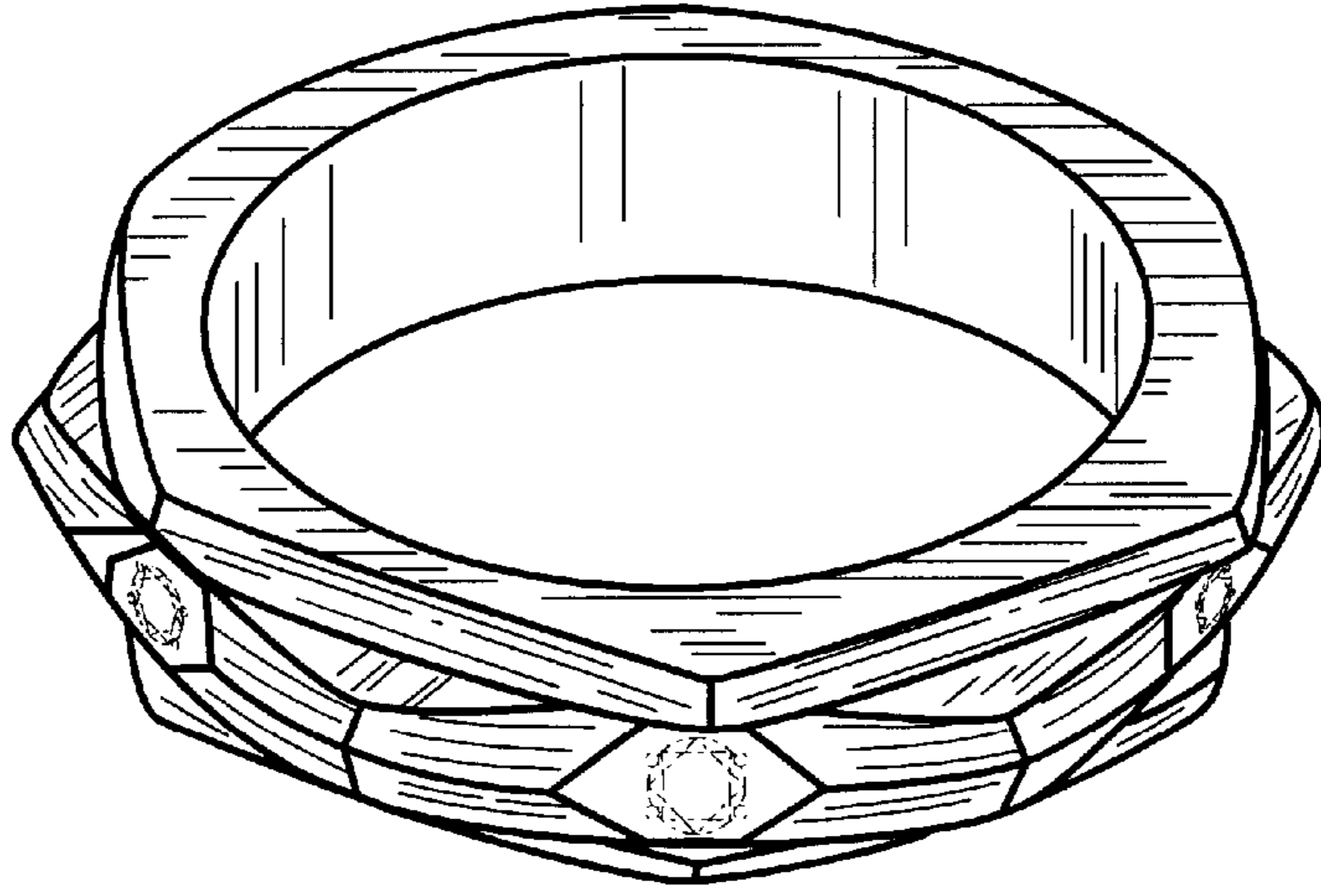

Fig. 4

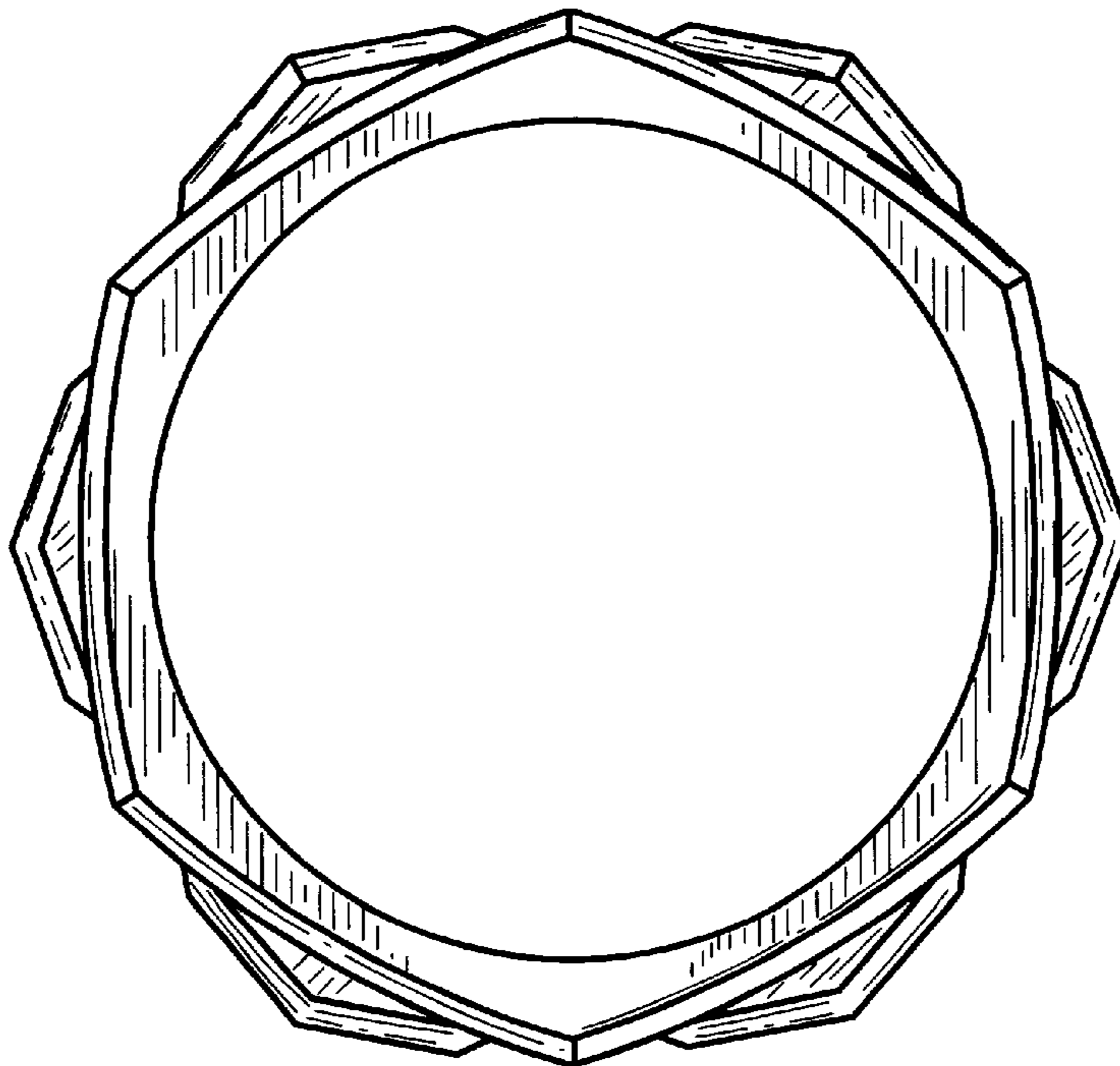

Fig. 5

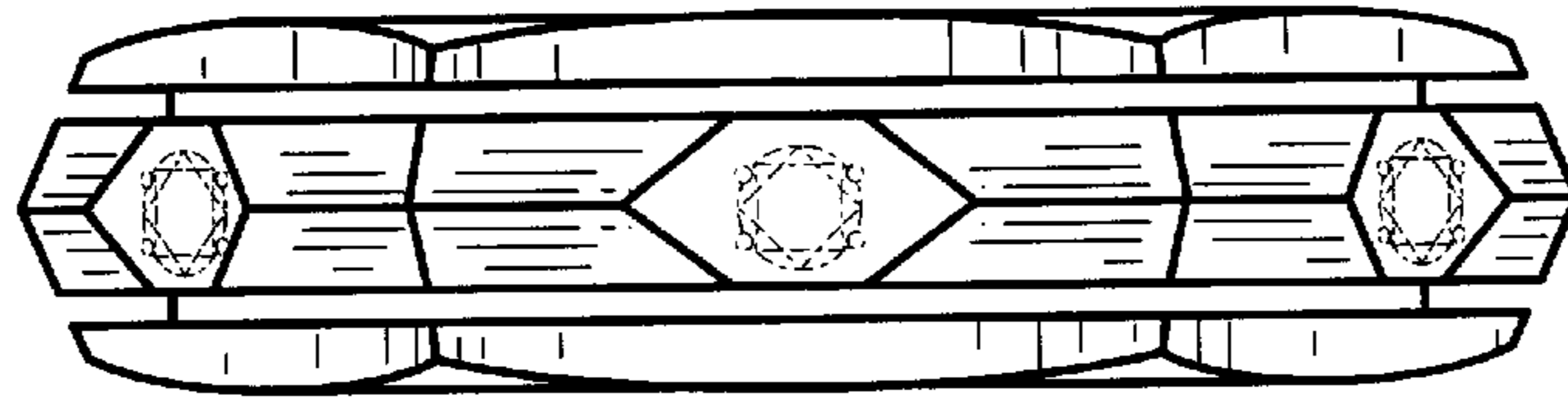

Fig. 6

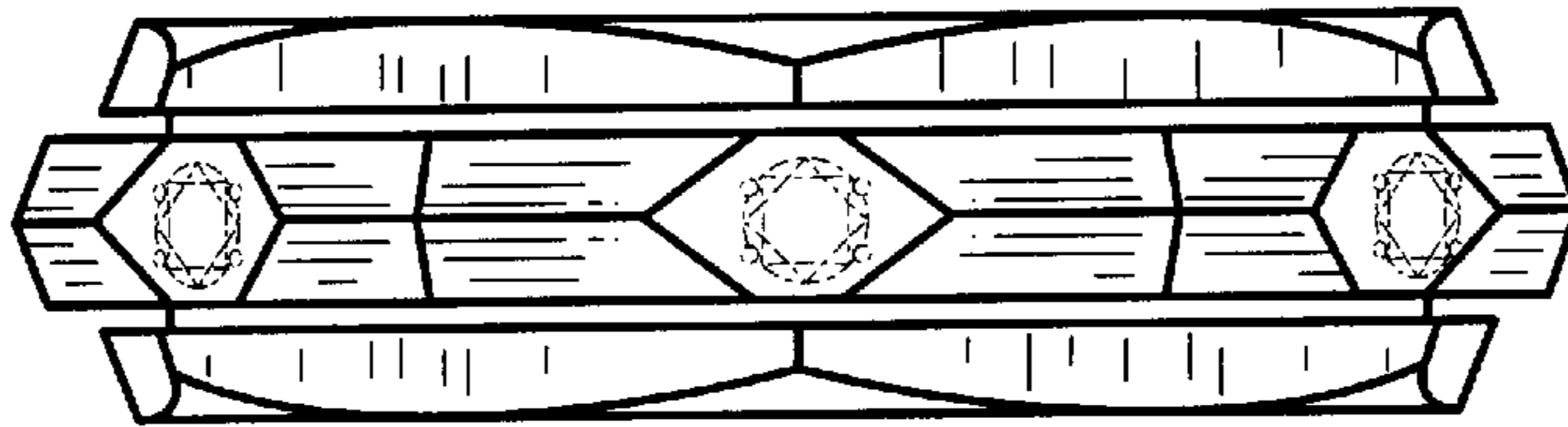

Fig. 7

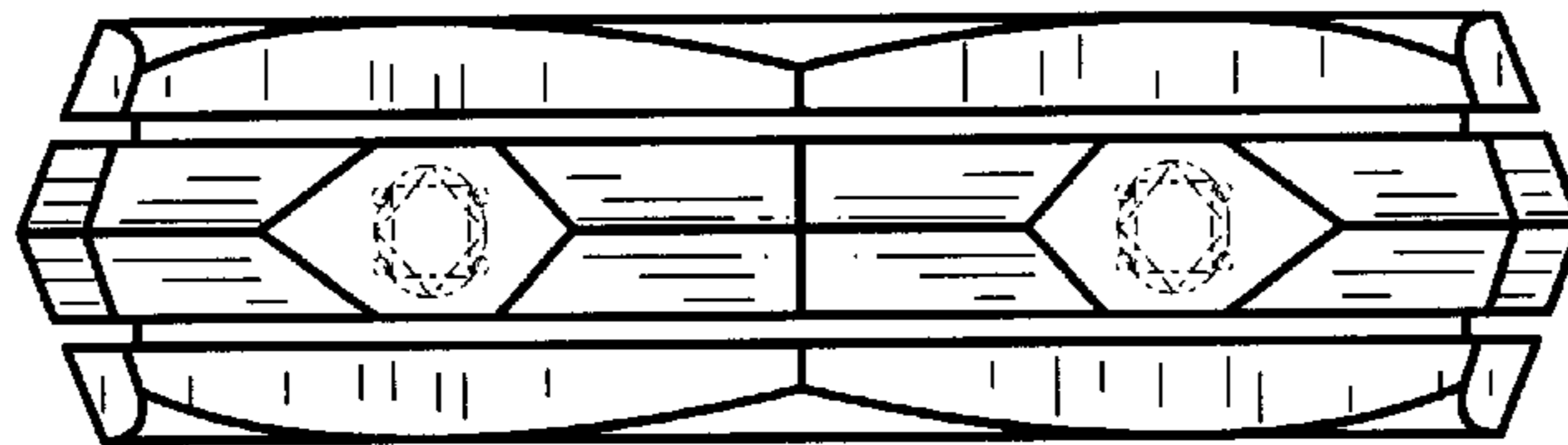

Fig. 8

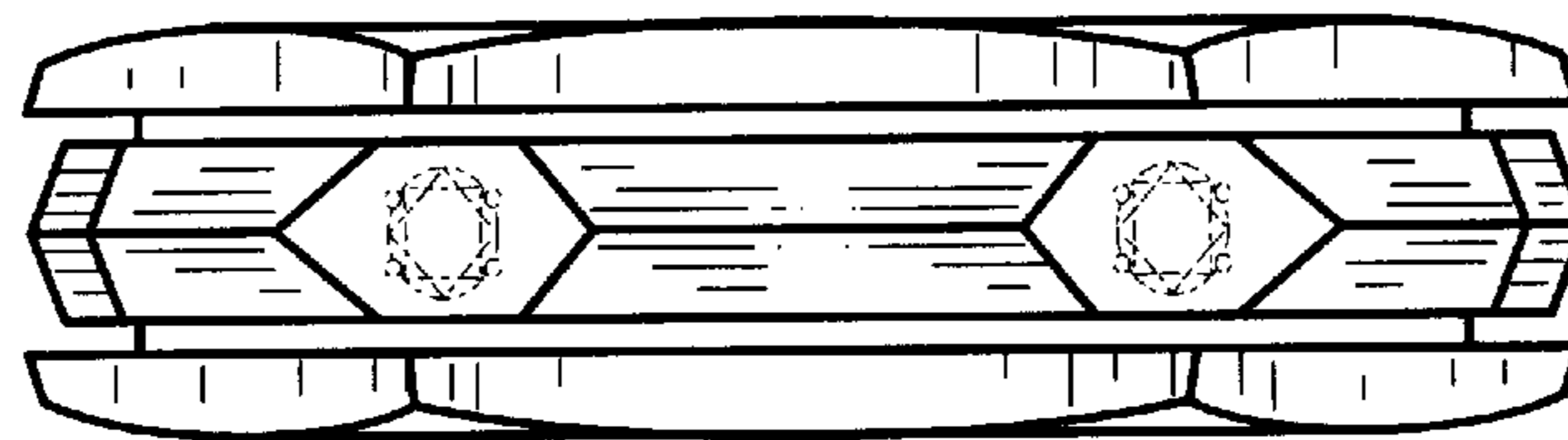

Fig. 9

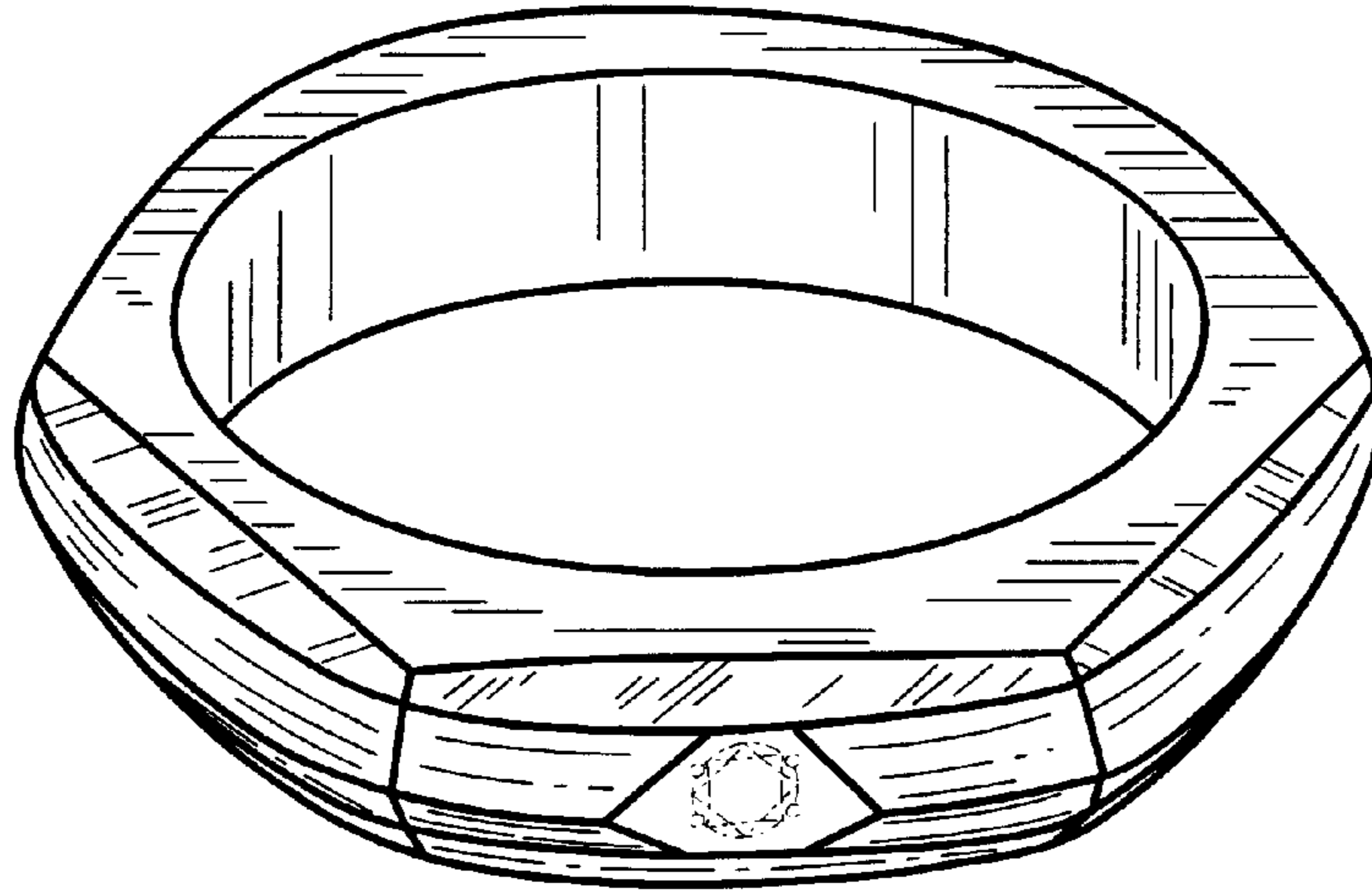

Fig. 11

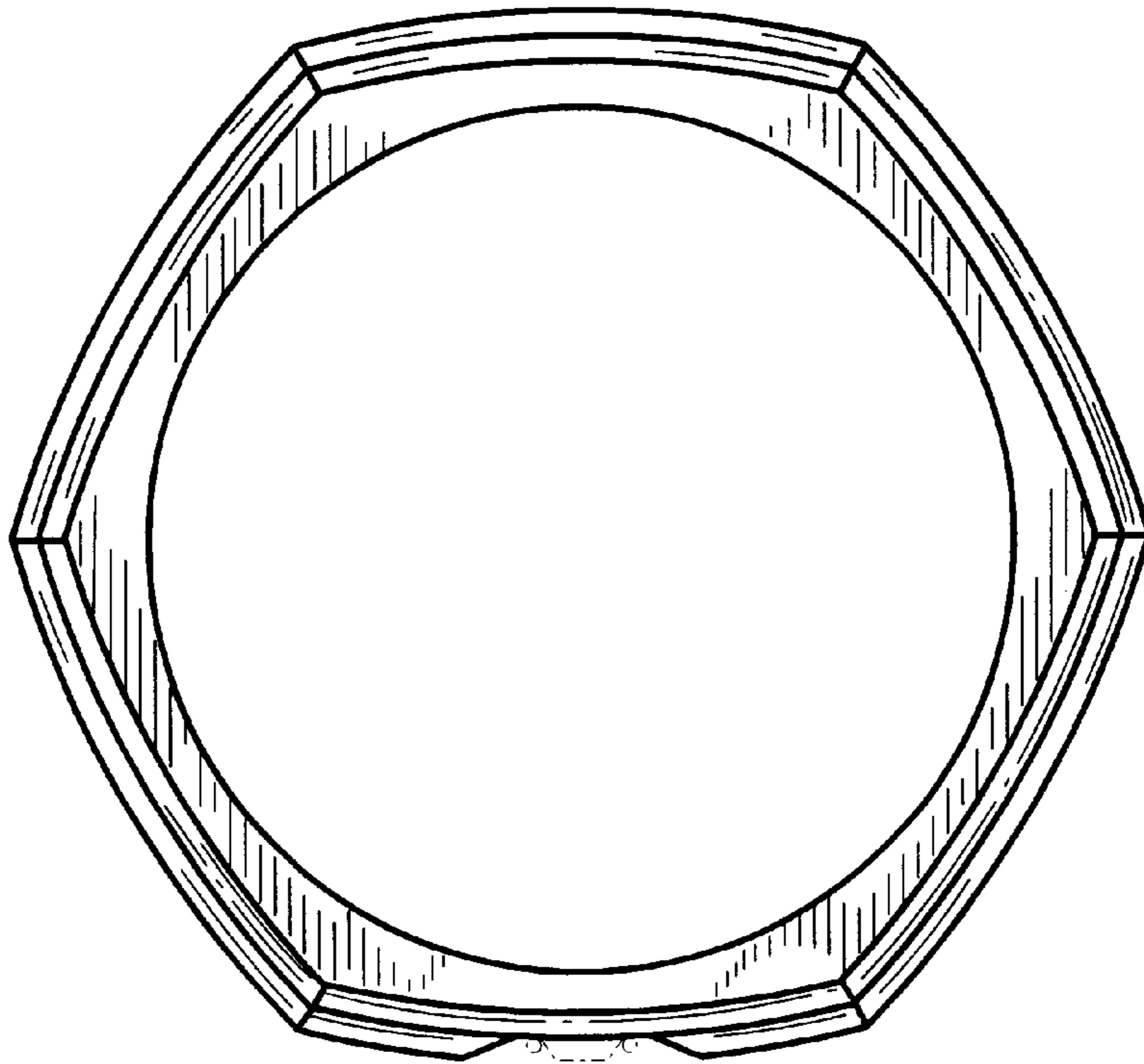

Fig.10

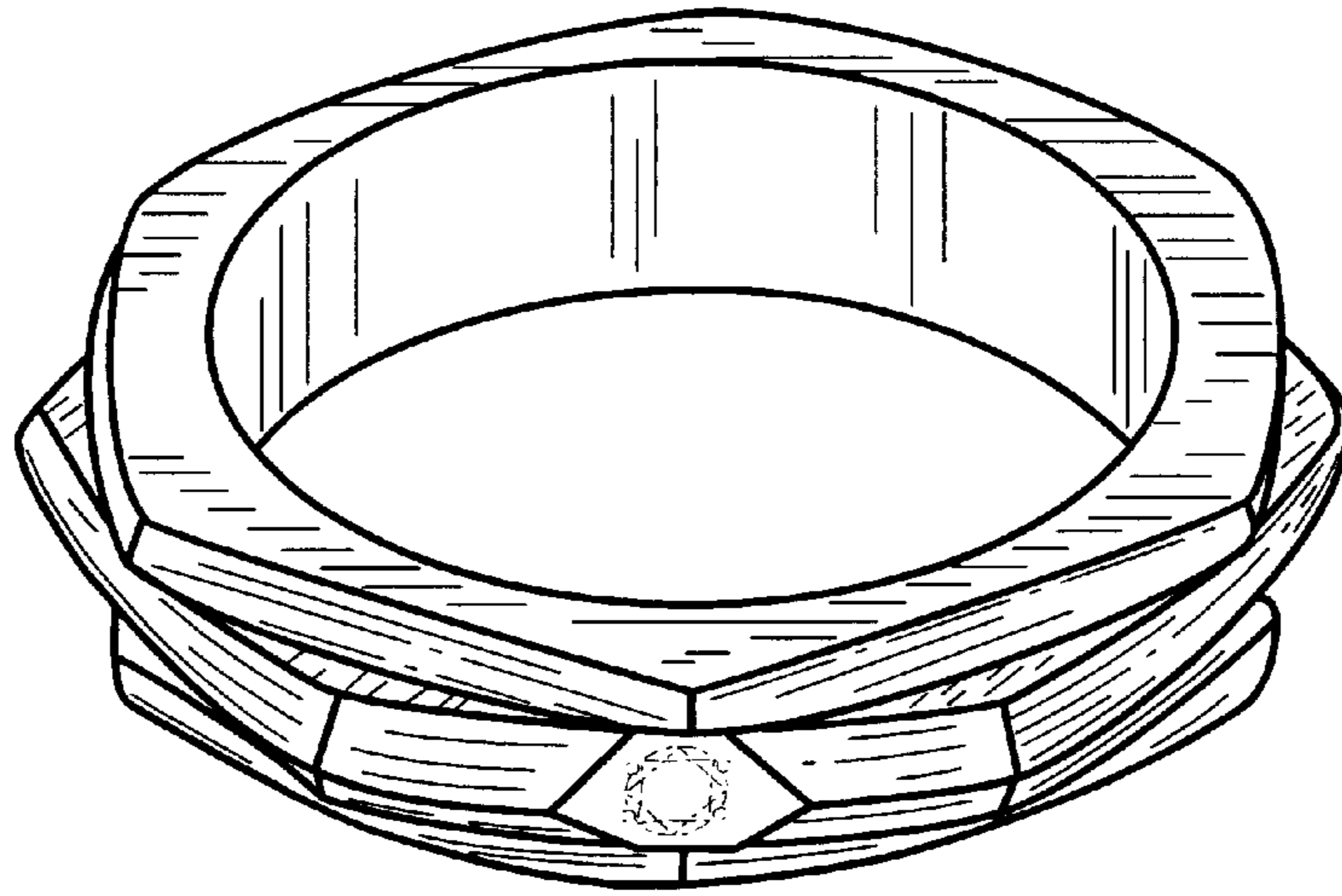

Fig.12

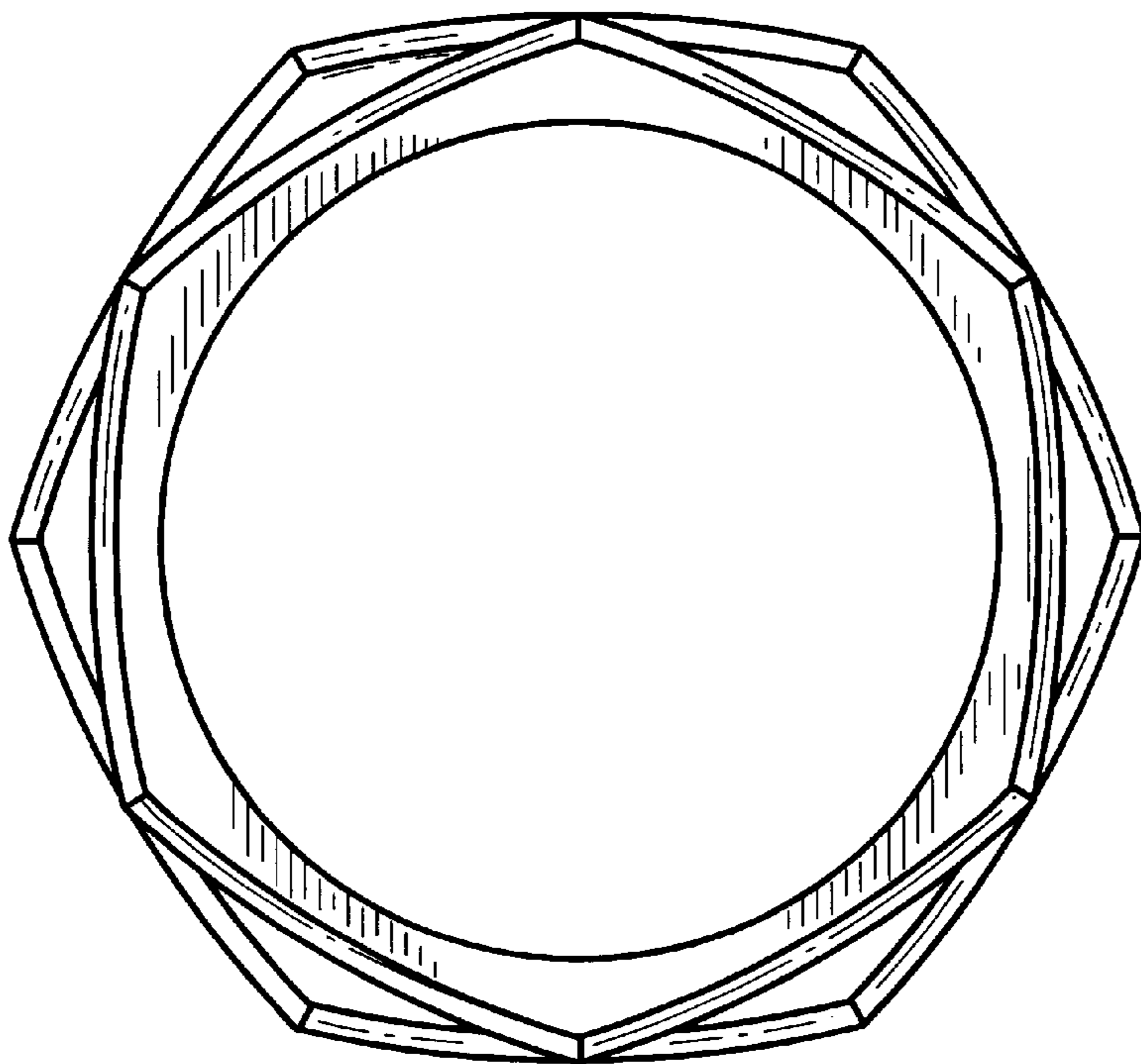

Fig.13

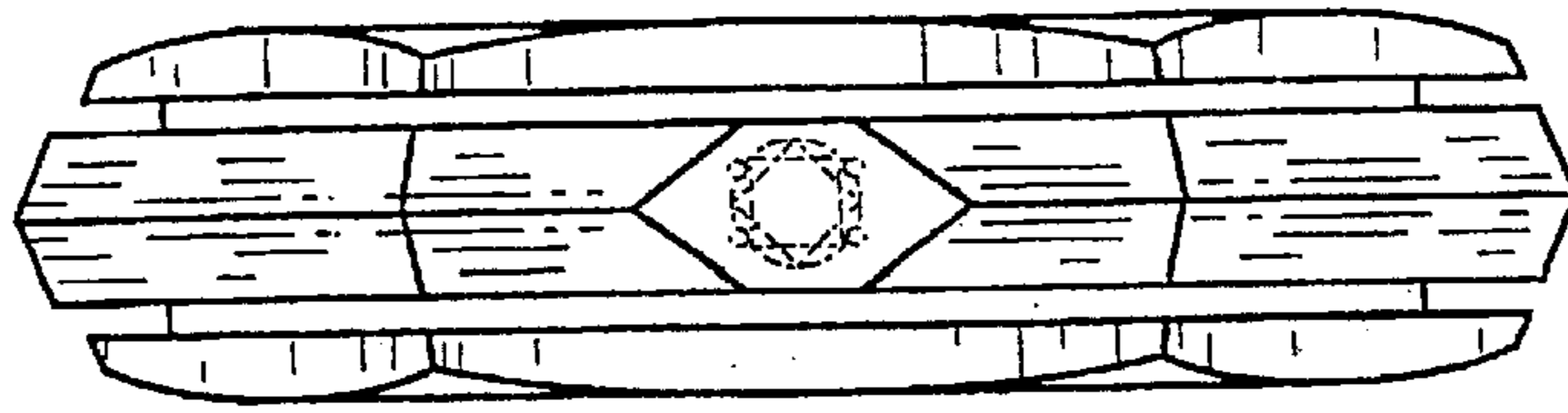

Fig.14

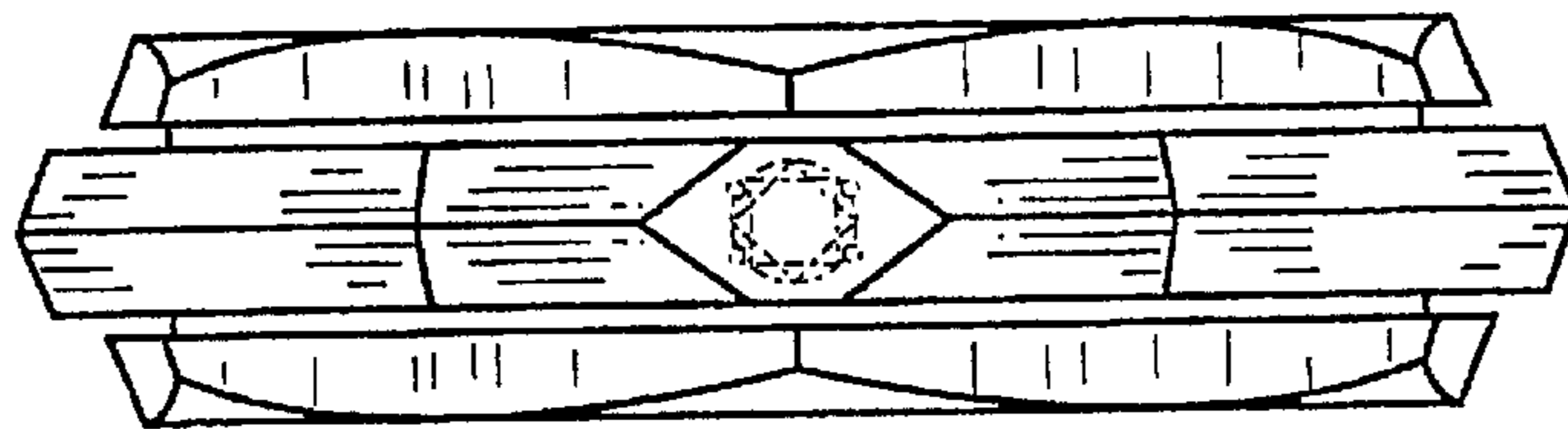

Fig.15

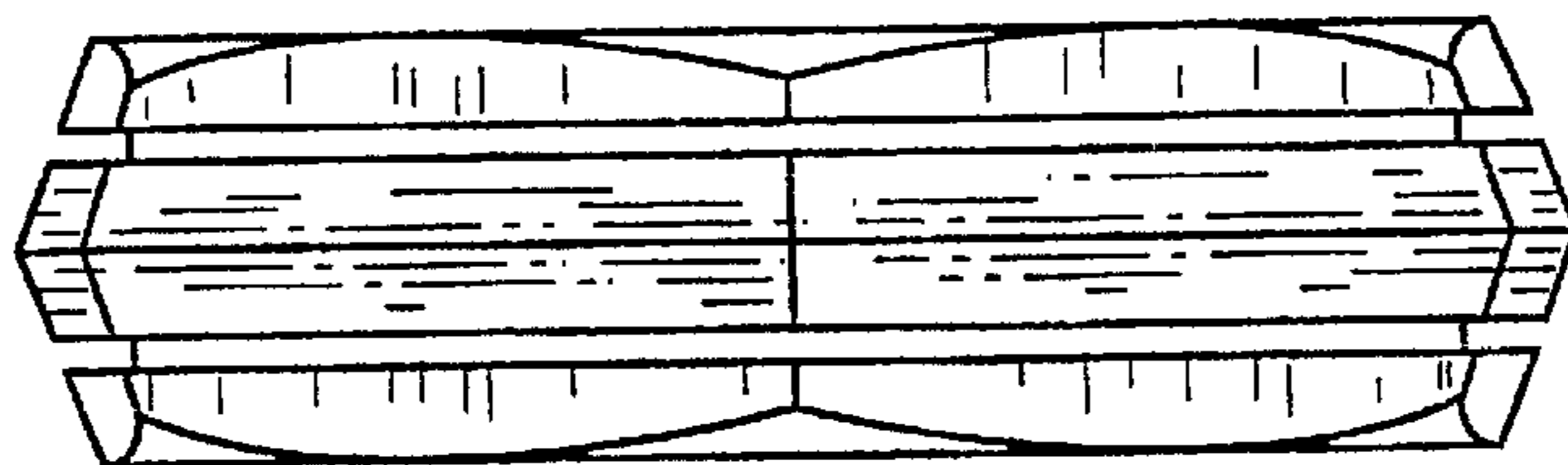

Fig.16

