



US00D454377S

(12) **United States Design Patent**
Hsu et al.

(10) **Patent No.:** **US D454,377 S**

(45) **Date of Patent:** **** Mar. 12, 2002**

(54) **SCOOTER**

D326,290 S * 5/1992 Badsey D12/110
D433,718 S * 11/2000 McGreen D21/423
6,206,387 B1 * 3/2001 Tsai 280/87.041

(75) Inventors: **Chen-Rong Hsu**, Taichung Hsien (TW); **Jenn-Jia Shu**, Eimonte, CA (US)

* cited by examiner

(73) Assignees: **Hao Yih Trading Co., Ltd.**, Taichung Hsien (TW); **Zenital Inc.**, El Monte, CA (US)

Primary Examiner—Raphael Barkai
(74) *Attorney, Agent, or Firm*—Rosenberg, Klein & Lee

(**) Term: **14 Years**

(57) **CLAIM**

(21) Appl. No.: **29/137,506**

The ornamental design for a scooter, as shown and described.

(22) Filed: **Feb. 22, 2001**

DESCRIPTION

(51) **LOC (7) Cl.** **21-01**

(52) **U.S. Cl.** **D21/423**

(58) **Field of Search** D21/419, 421, D21/423, 424, 426, 435, 533, 760, 765, 771; D12/107, 110-112; 280/87.01, 87.04, 87.041, 87.042, 87.05, 278, 287; 180/180, 181, 216, 219, 220

FIG. 1 is a perspective view of scooter showing our new design;

FIG. 2 is a front elevation view thereof;

FIG. 3 is a rear elevation view thereof;

FIG. 4 is a left side elevation view thereof;

FIG. 5 is a right side elevation view thereof;

FIG. 6 is a top plan view thereof; and,

FIG. 7 is a bottom plan view thereof.

(56) **References Cited**

U.S. PATENT DOCUMENTS

4,842,091 A * 6/1989 Badsey 180/219

1 Claim, 5 Drawing Sheets

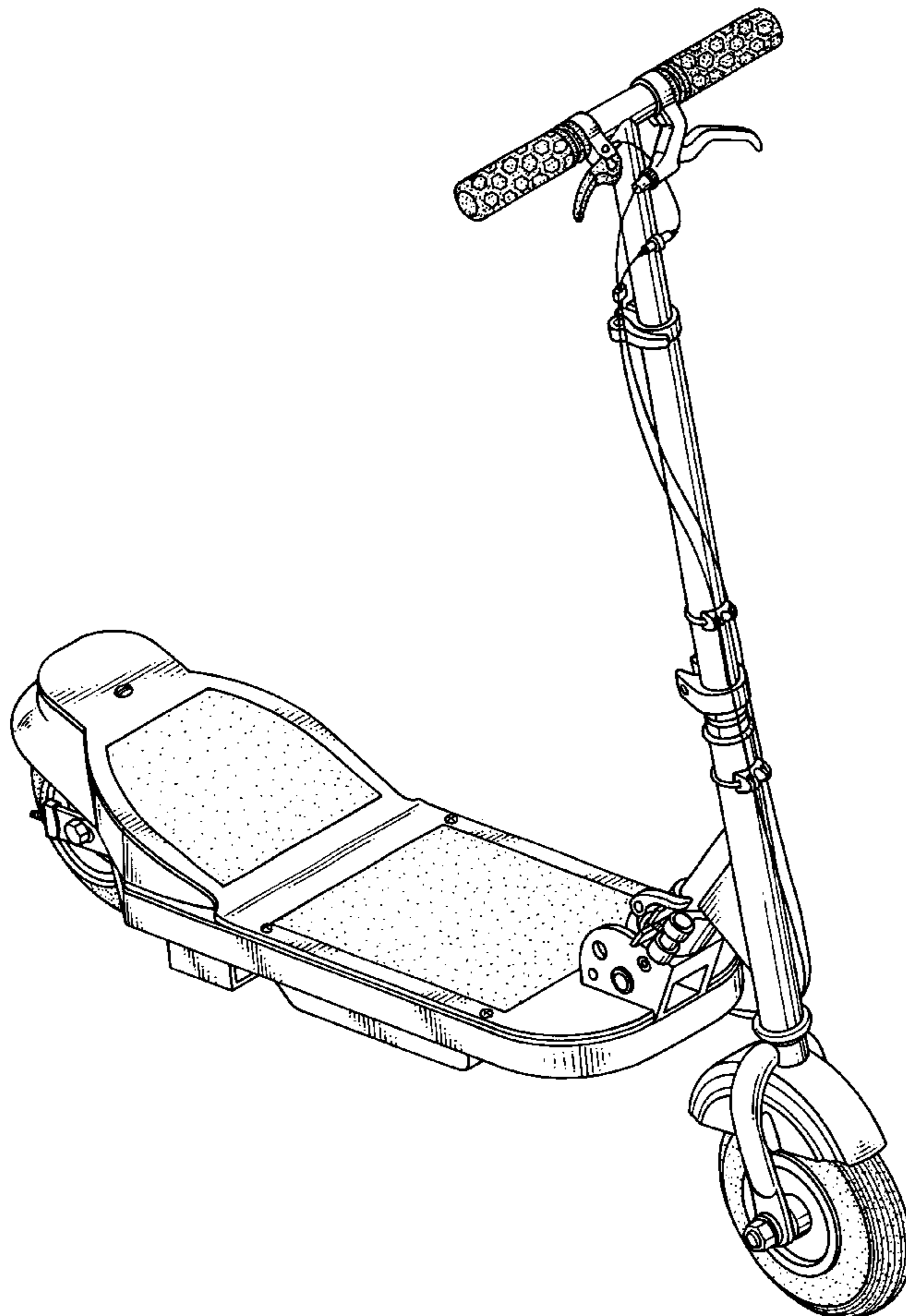

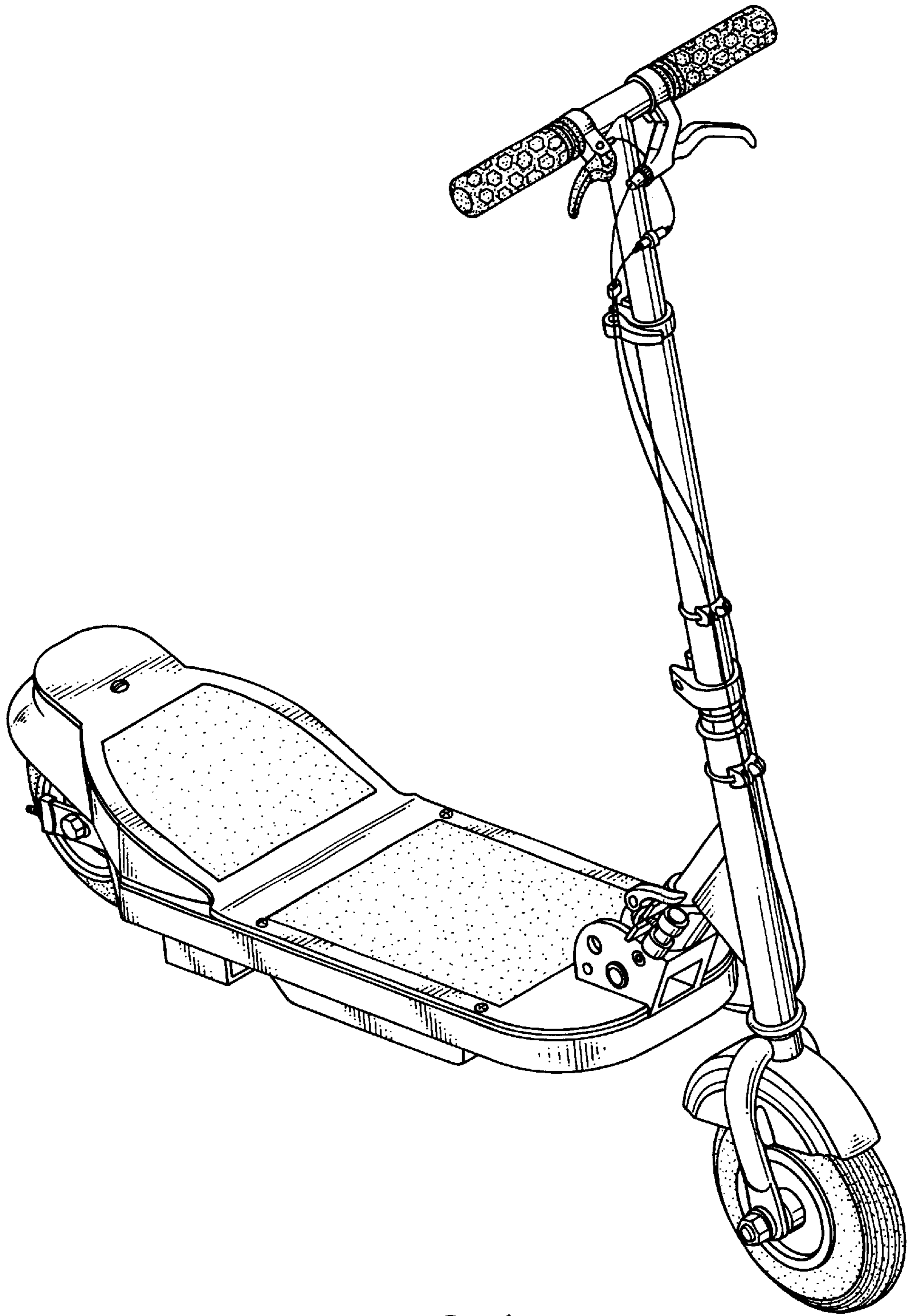

FIG. 1

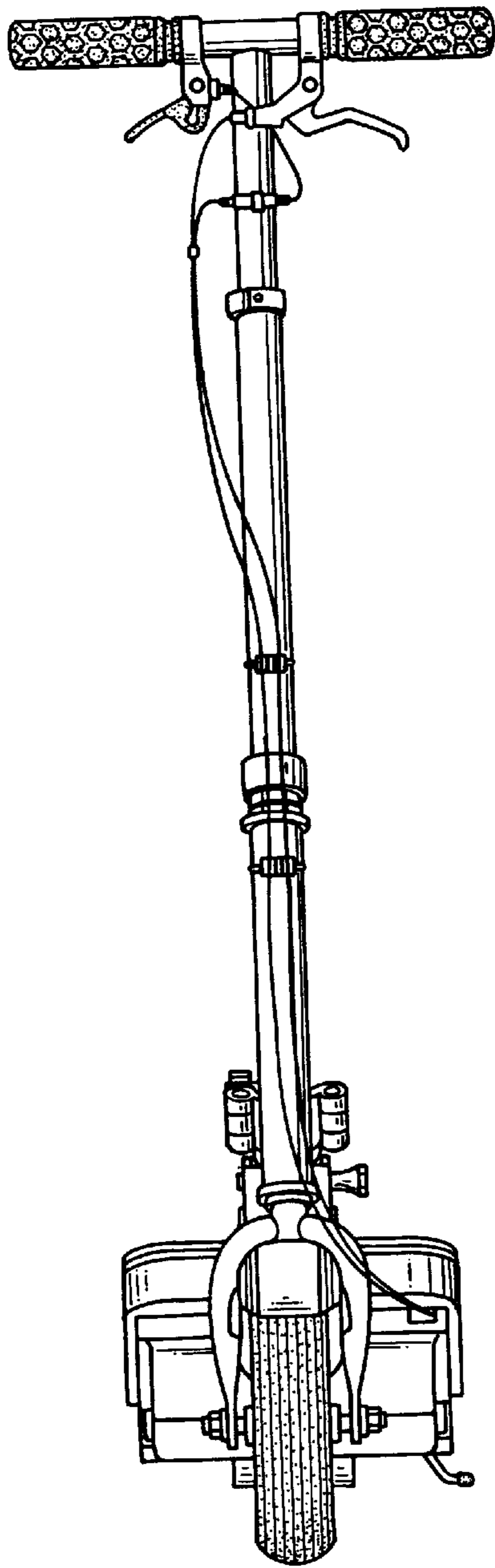

FIG. 2

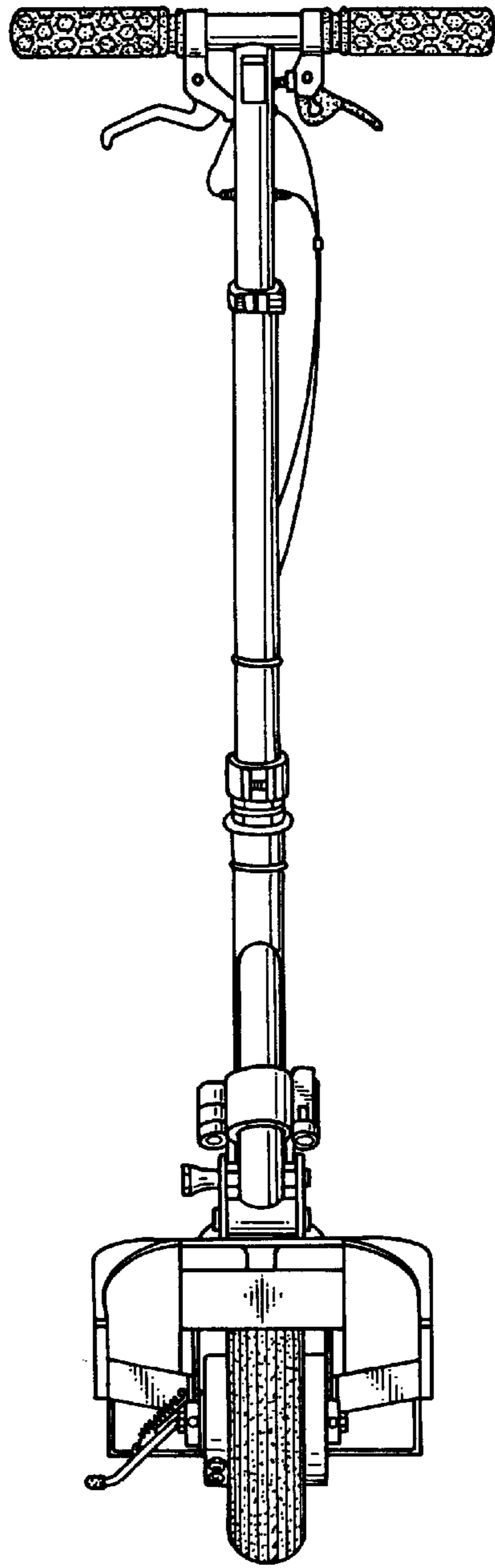

FIG. 3



FIG. 4

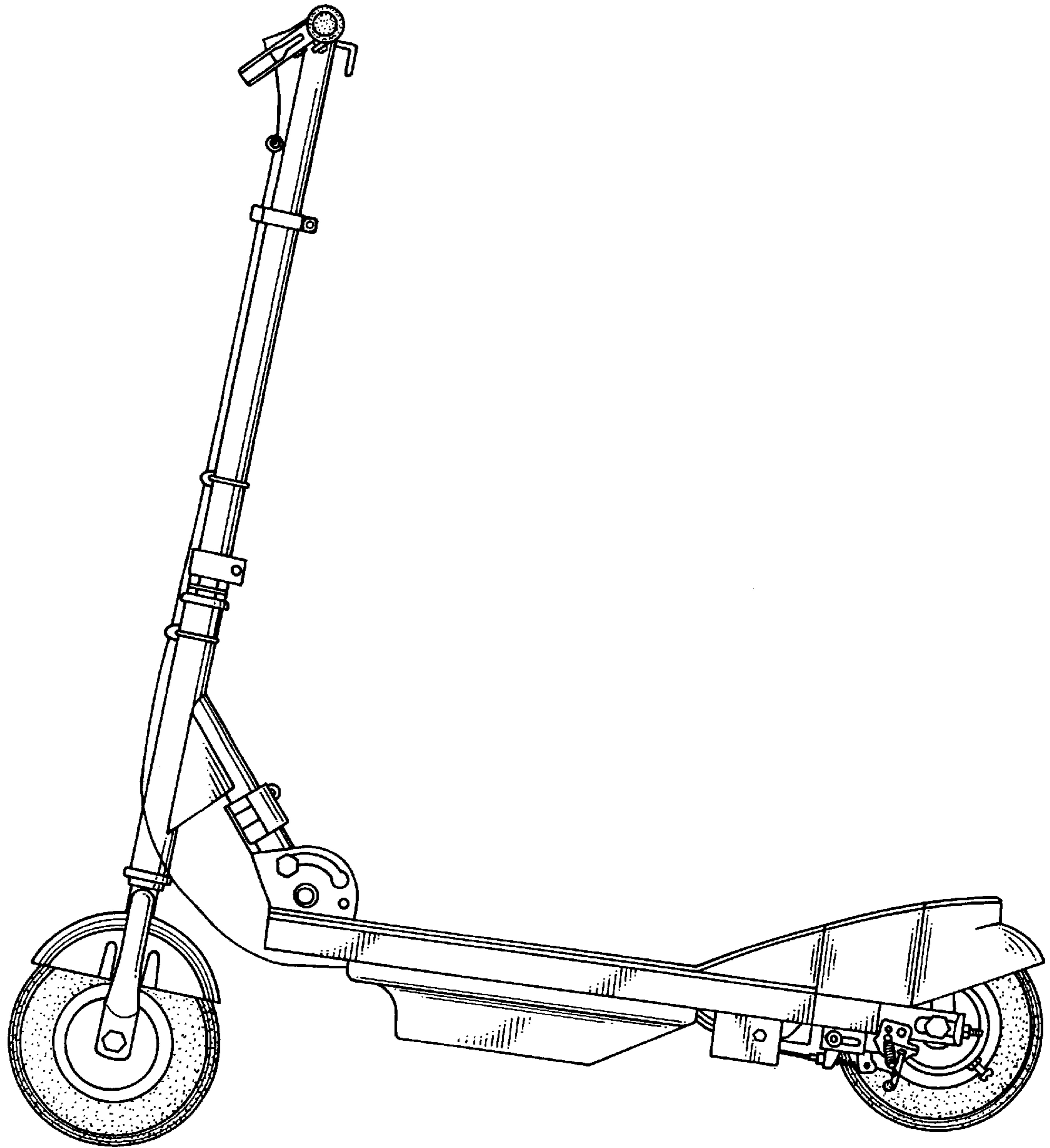

FIG. 5

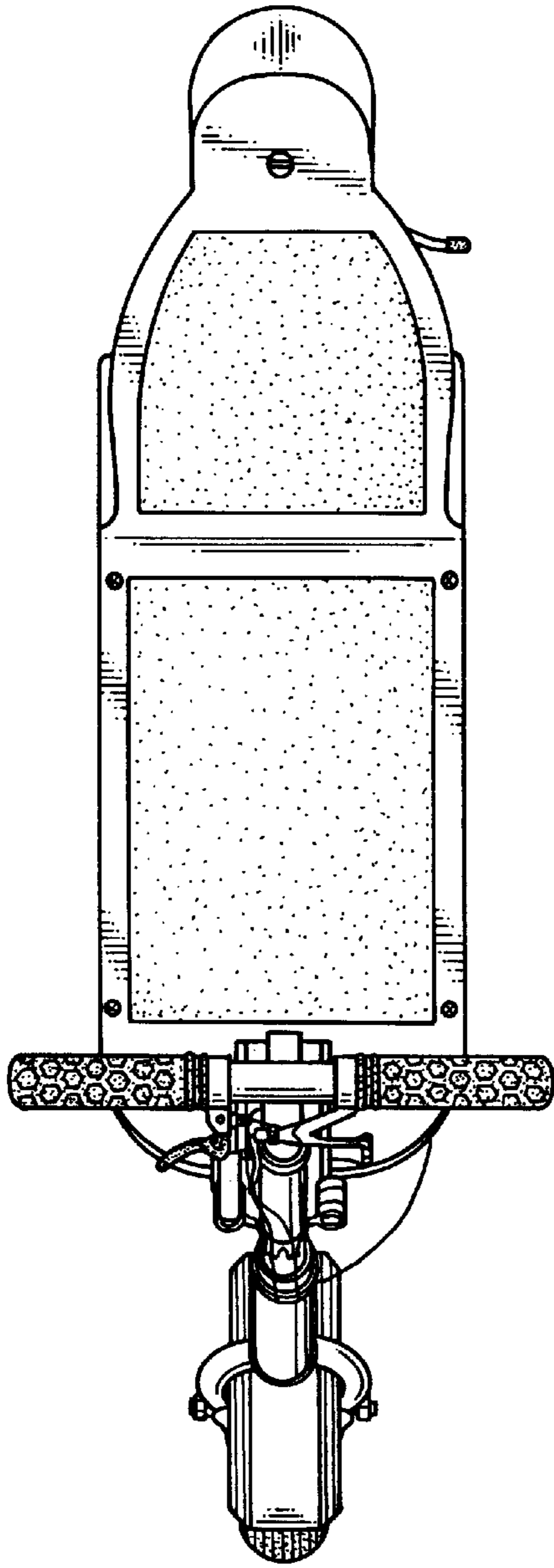

FIG. 6

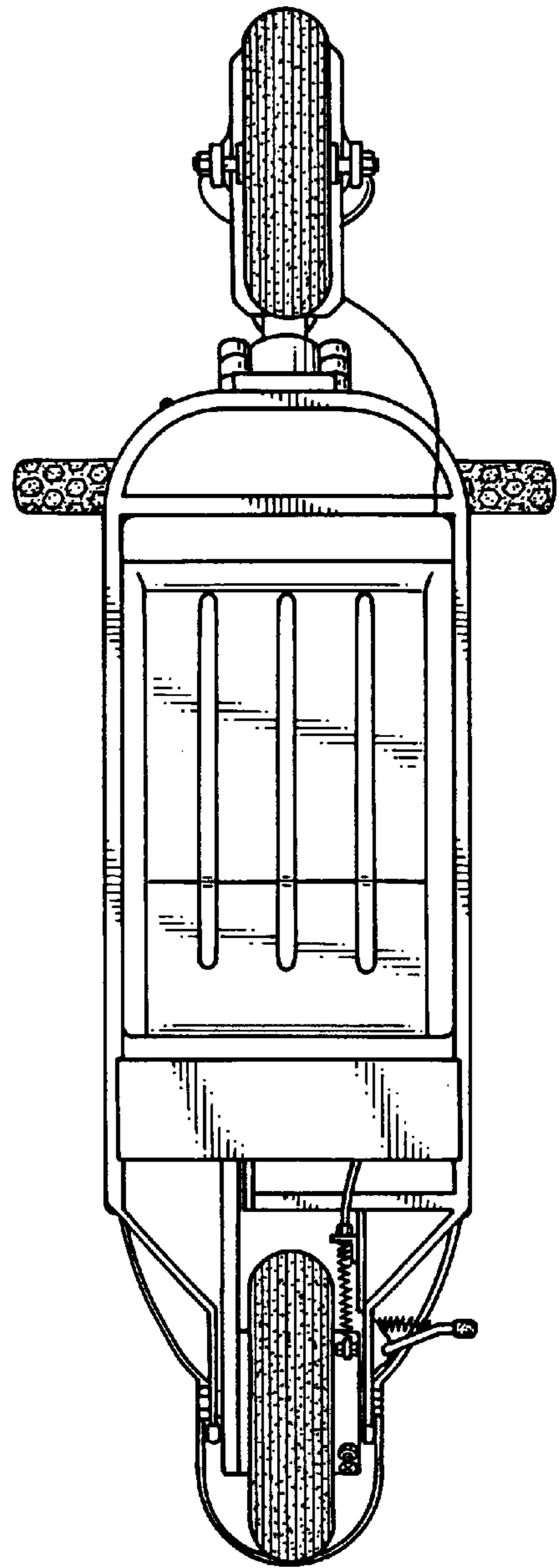

FIG. 7