



US00D454306S

(12) **United States Design Patent**
Sweeton et al.

(10) **Patent No.:** **US D454,306 S**
(45) **Date of Patent:** **** Mar. 12, 2002**

(54) **TEXTURED PAD TRIGGER LEVER FOR PUMP DISPENSER**

(75) Inventors: **Steven L. Sweeton**, Lee's Summit, MO (US); **Joseph R. Krestine**, Leawood, KS (US)

(73) Assignee: **Saint-Gobain Calmar Inc.**, City of Industry, CA (US)

(**) Term: **14 Years**

(21) Appl. No.: **29/140,591**

(22) Filed: **Apr. 23, 2001**

(51) **LOC (7) Cl.** **09-07**

(52) **U.S. Cl.** **D9/434; D9/448**

(58) **Field of Search** D9/434, 447, 448, D9/300, 301, 499; 222/383.1, 304, 323, 324

(56) **References Cited**

U.S. PATENT DOCUMENTS

4,917,303 A *	4/1990	Maas	222/383.1
5,706,984 A *	1/1998	Tada et al.	222/383.1
5,762,236 A	6/1998	Foster et al.	
D406,060 S	2/1999	Dumont et al.	
D409,487 S *	5/1999	Wadsworth	D9/448
D417,151 S	11/1999	Spengler	
D421,718 S	3/2000	Durliat et al.	
6,216,912 B1 *	4/2001	Keung et al.	222/383.1
D446,721 S *	8/2001	Kimble et al.	D9/448

* cited by examiner

Primary Examiner—Dominic Simone

(74) *Attorney, Agent, or Firm*—Dykema Gossett PLLC

(57) **CLAIM**

The ornamental design for a textured pad trigger lever for pump dispenser, as shown and described.

DESCRIPTION

FIG. 1 is a perspective view of a first embodiment of the textured pad trigger lever for pump dispenser of the present invention. The textured pad is shown stippled and is of contrasting color to that of the remainder of the lever. Environmental parts are shown in broken lines for illustrative purposes only and form no part of the claimed design. FIG. 2 is a front elevational view thereof; FIG. 3 is a left side elevational view thereof, the right side elevational view being a mirror image of the left side elevational view; FIG. 4 is a back view thereof; FIG. 5 is a sectional view taken along the line 5—5 of FIG. 2 illustrating the textured pad of a different plastic material; FIG. 6 is a top view thereof; FIG. 7 is a bottom view thereof; FIG. 8 is a front elevational view of a second embodiment of the textured pad trigger lever for pump dispenser according to the invention, the textured pad being shown stippled; FIG. 9 is a left side elevational view thereof, the right side elevational view being a mirror image of the left side elevational view; FIG. 10 is a rear view thereof; FIG. 11 is a section view taken along the line 11—11 of FIG. 8 illustrating the textured pad of the same plastic material; FIG. 12 is a top view thereof; and, FIG. 13 is a bottom view thereof.

1 Claim, 3 Drawing Sheets

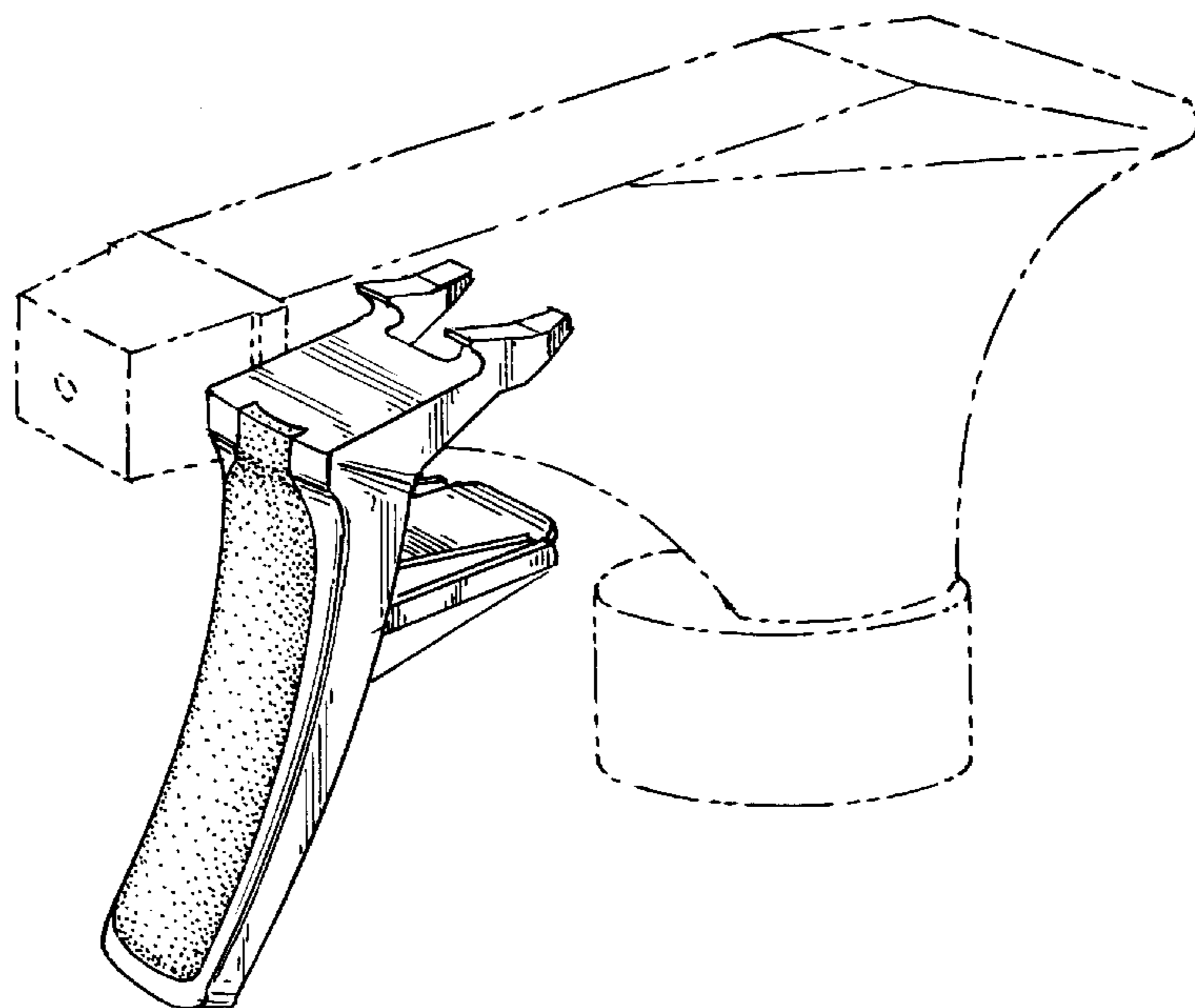

FIG. 1

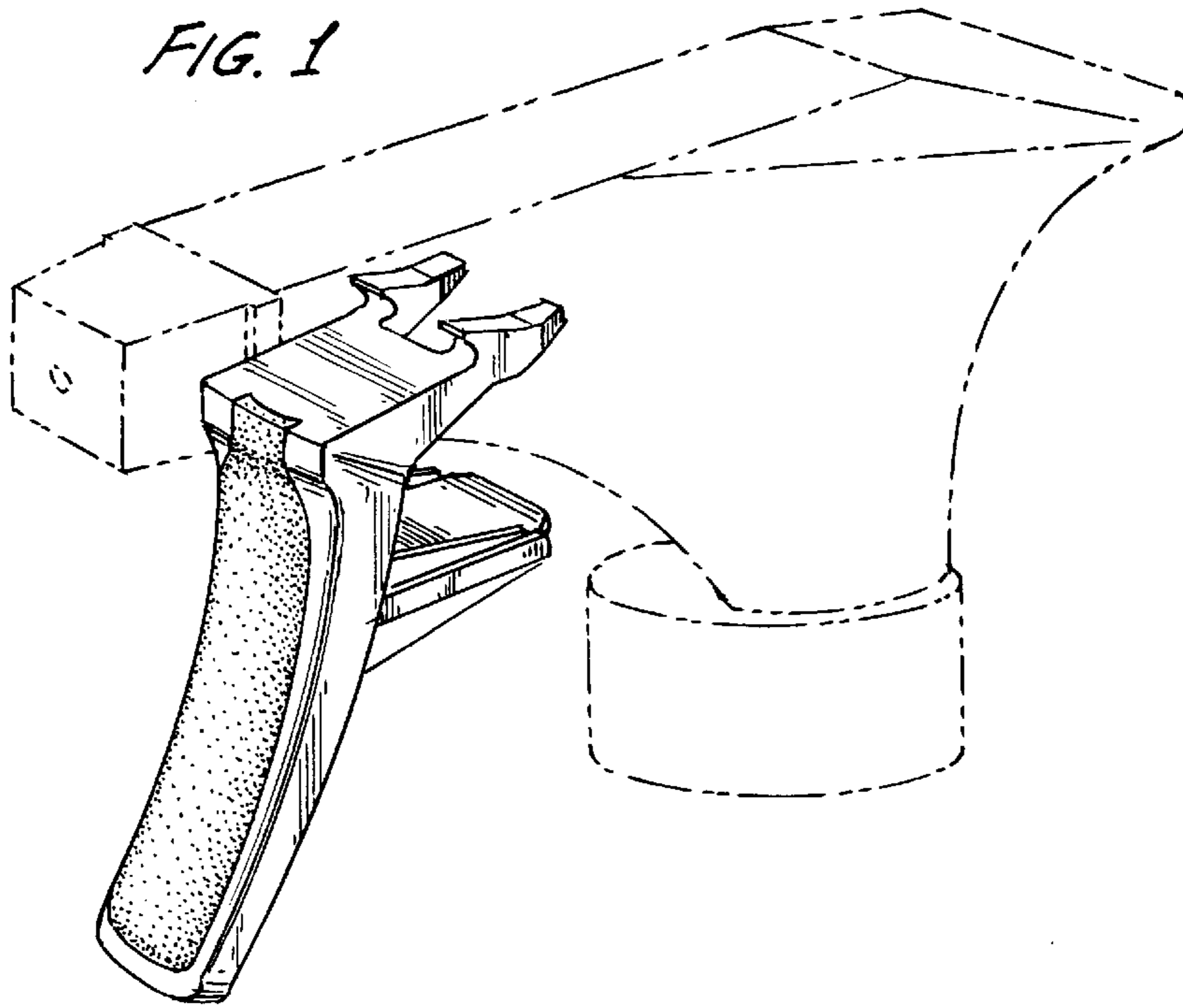

FIG. 2

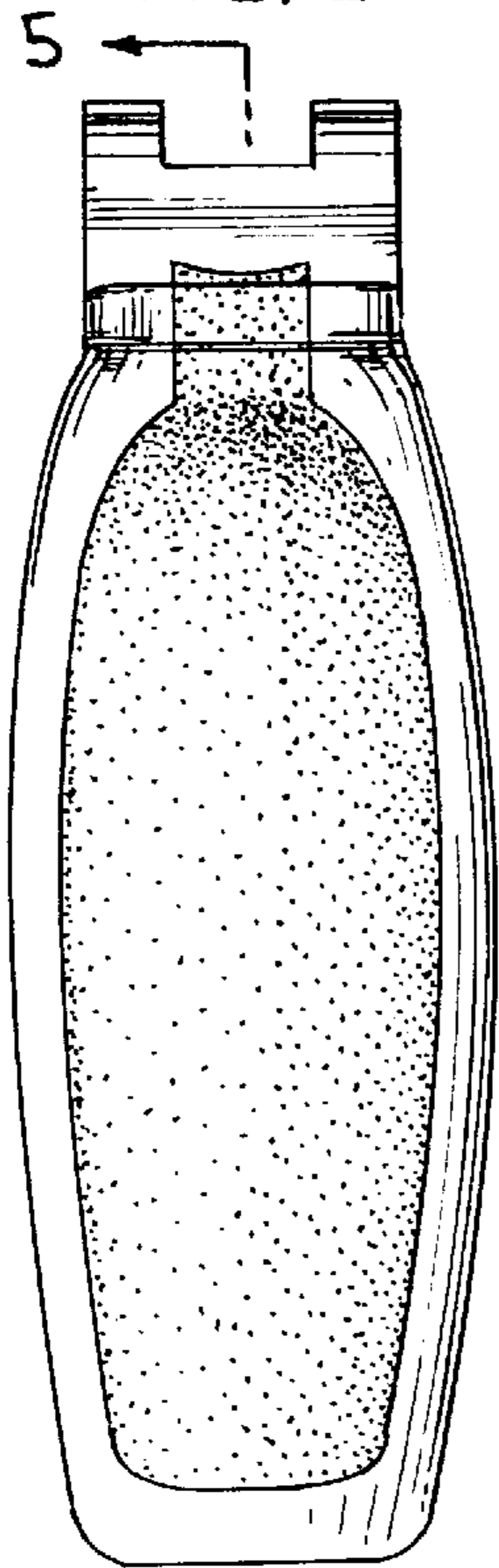

FIG. 3

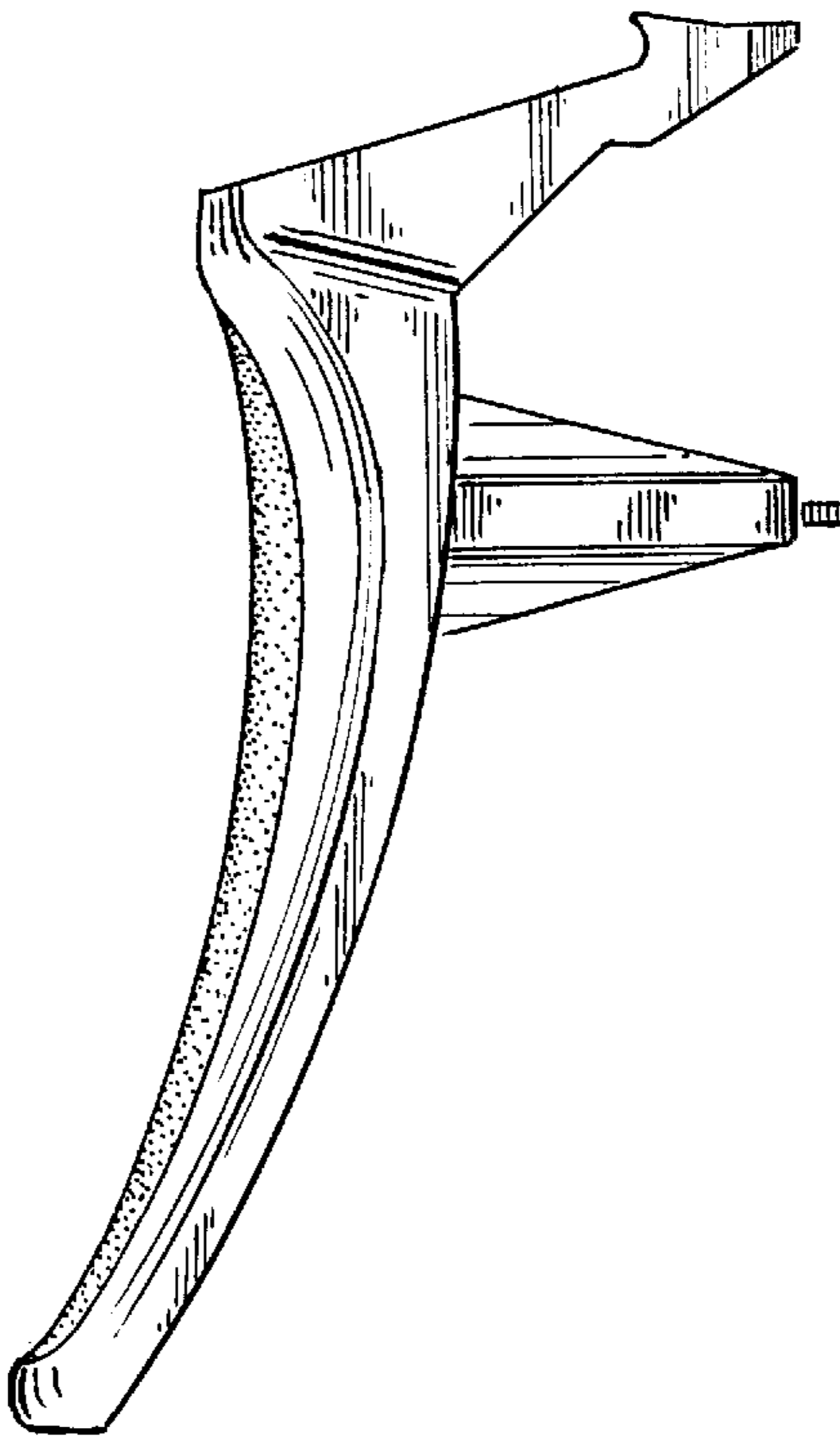

FIG. 4

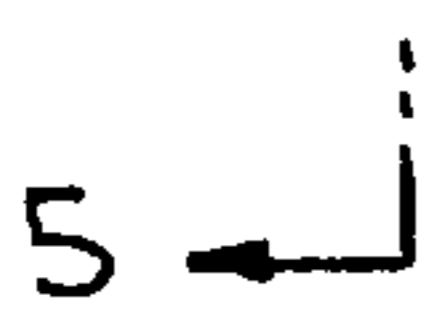
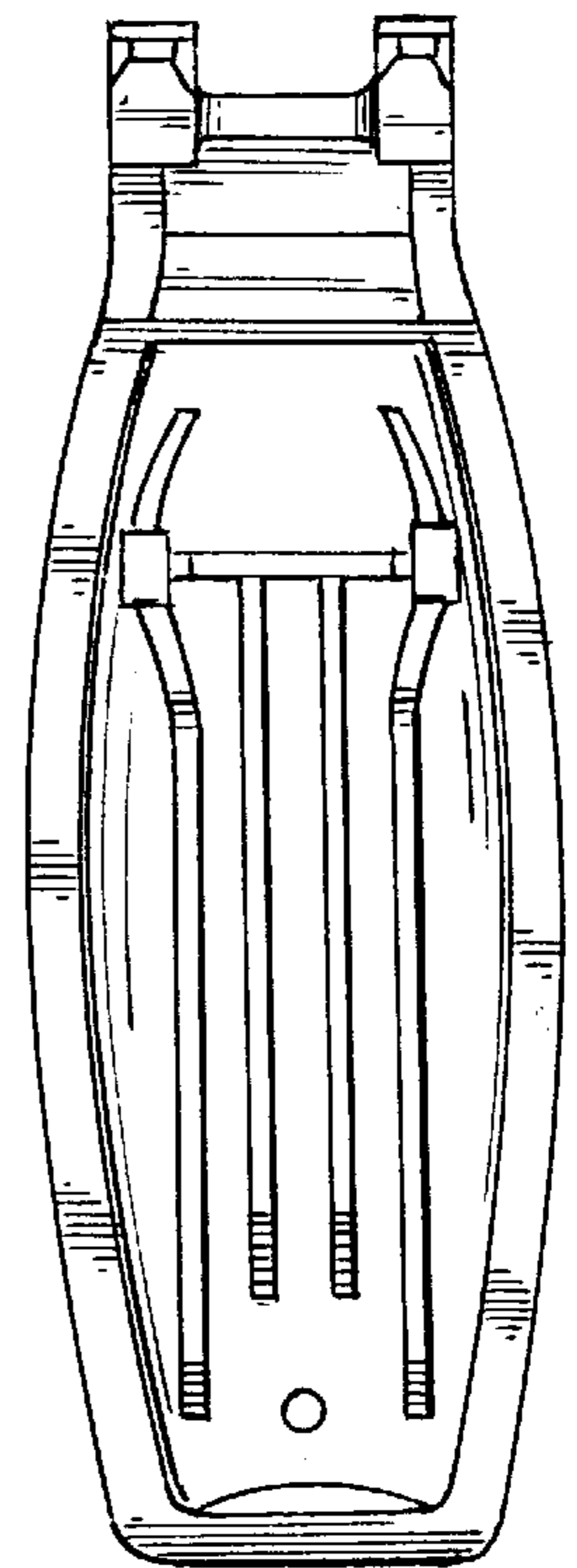

FIG. 5

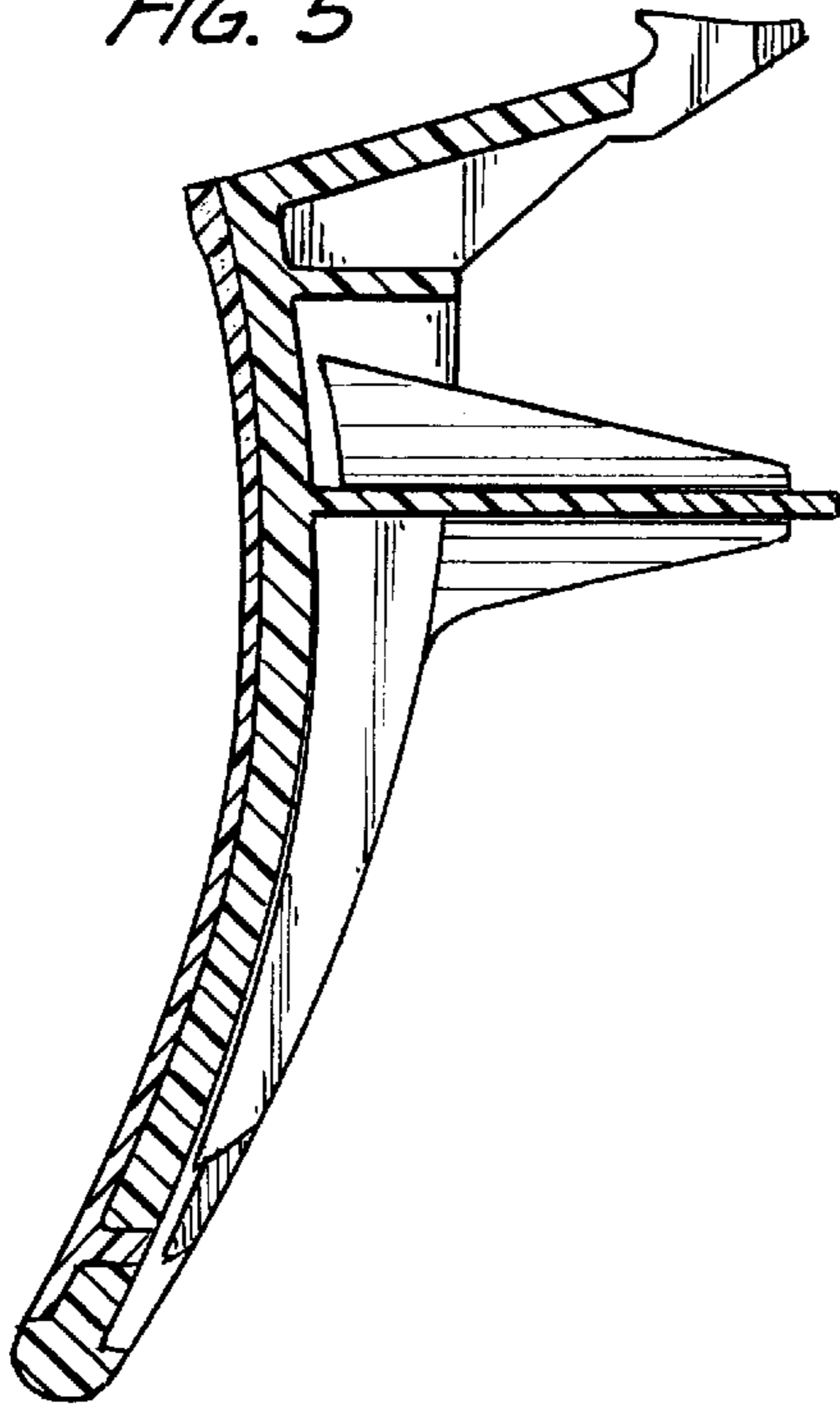

FIG. 6

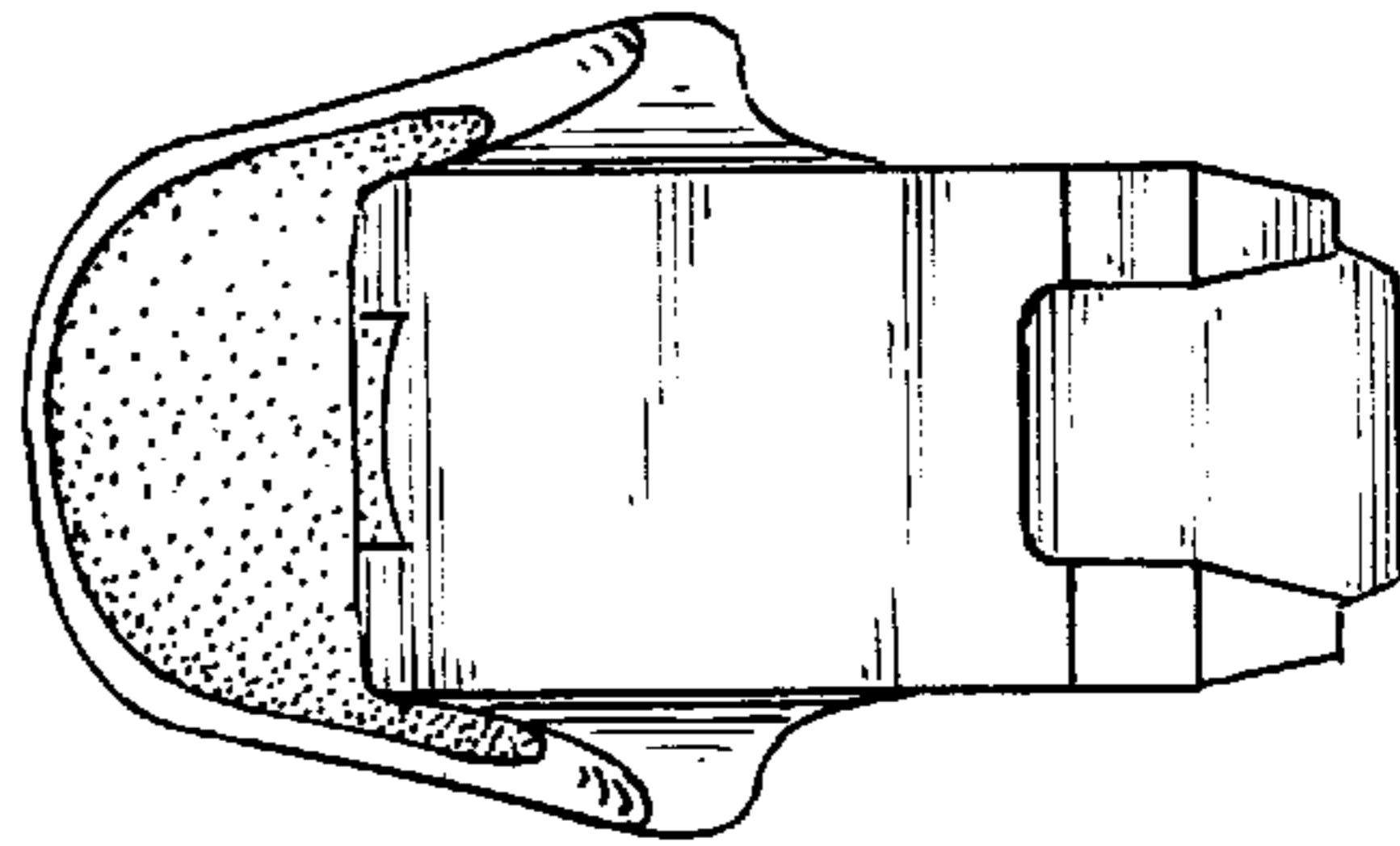

FIG. 7

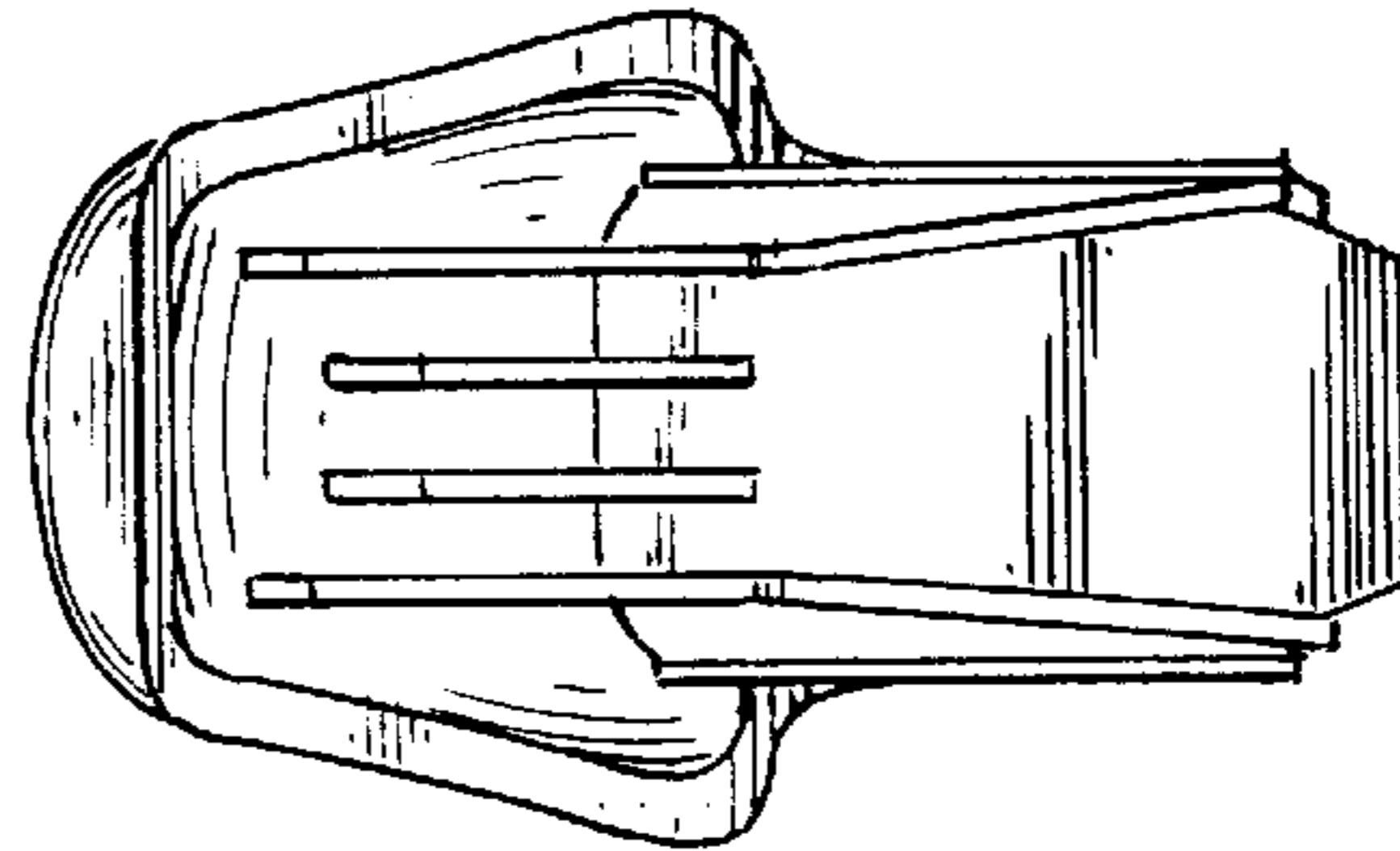

FIG. 8

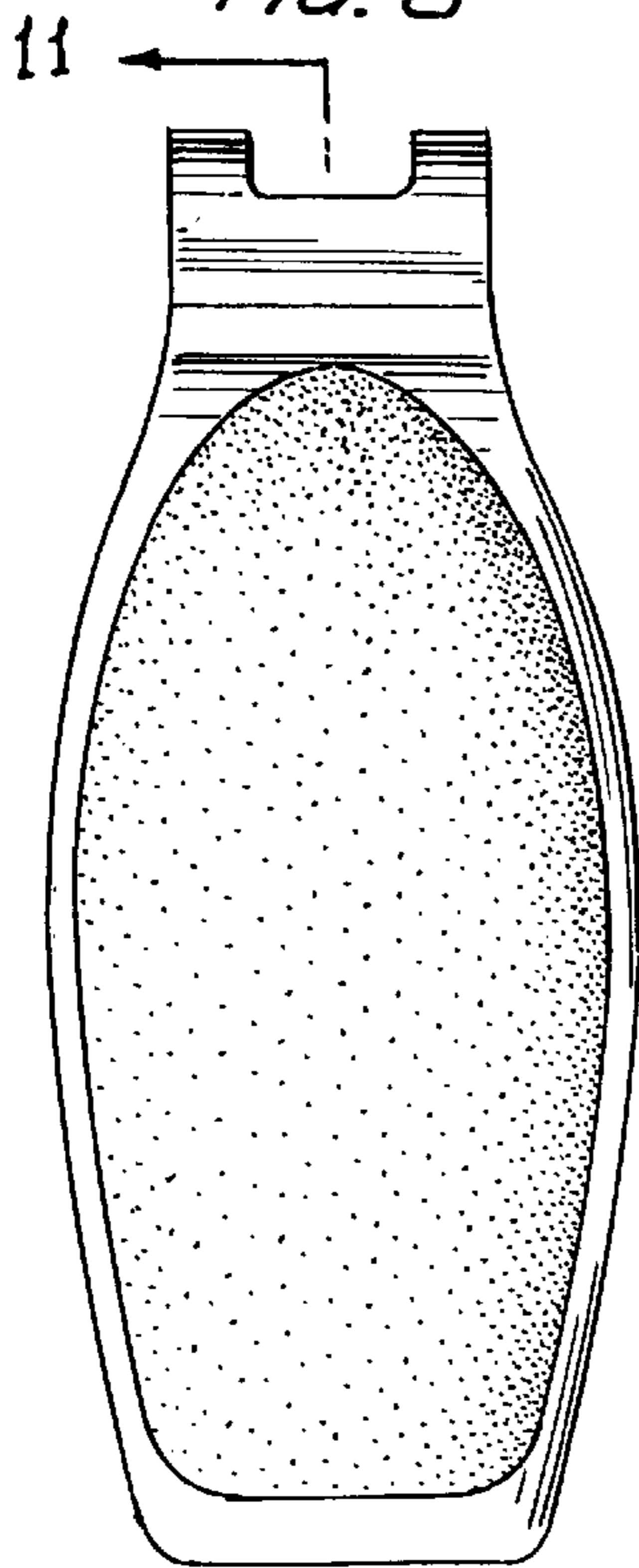

FIG. 9

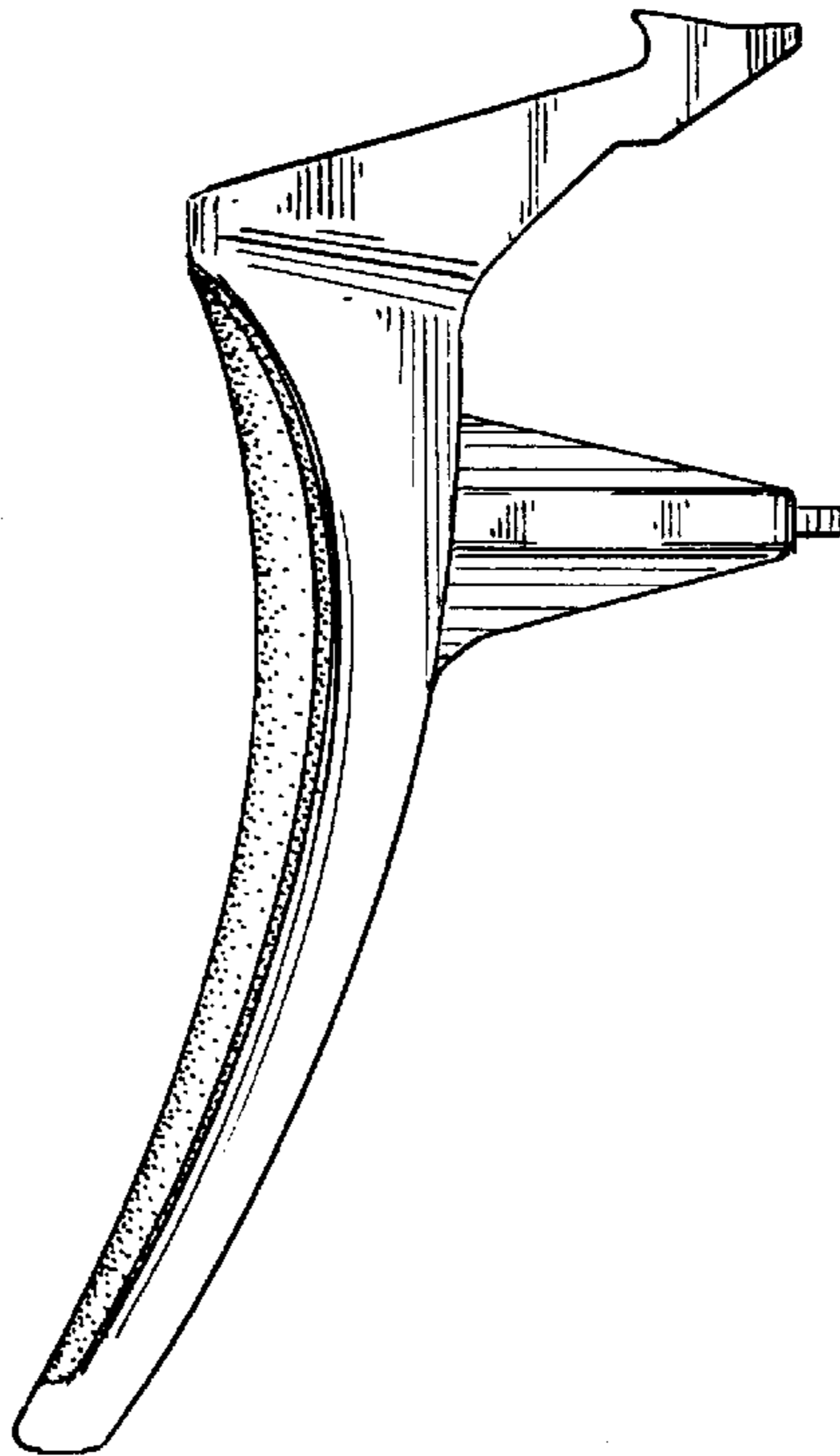
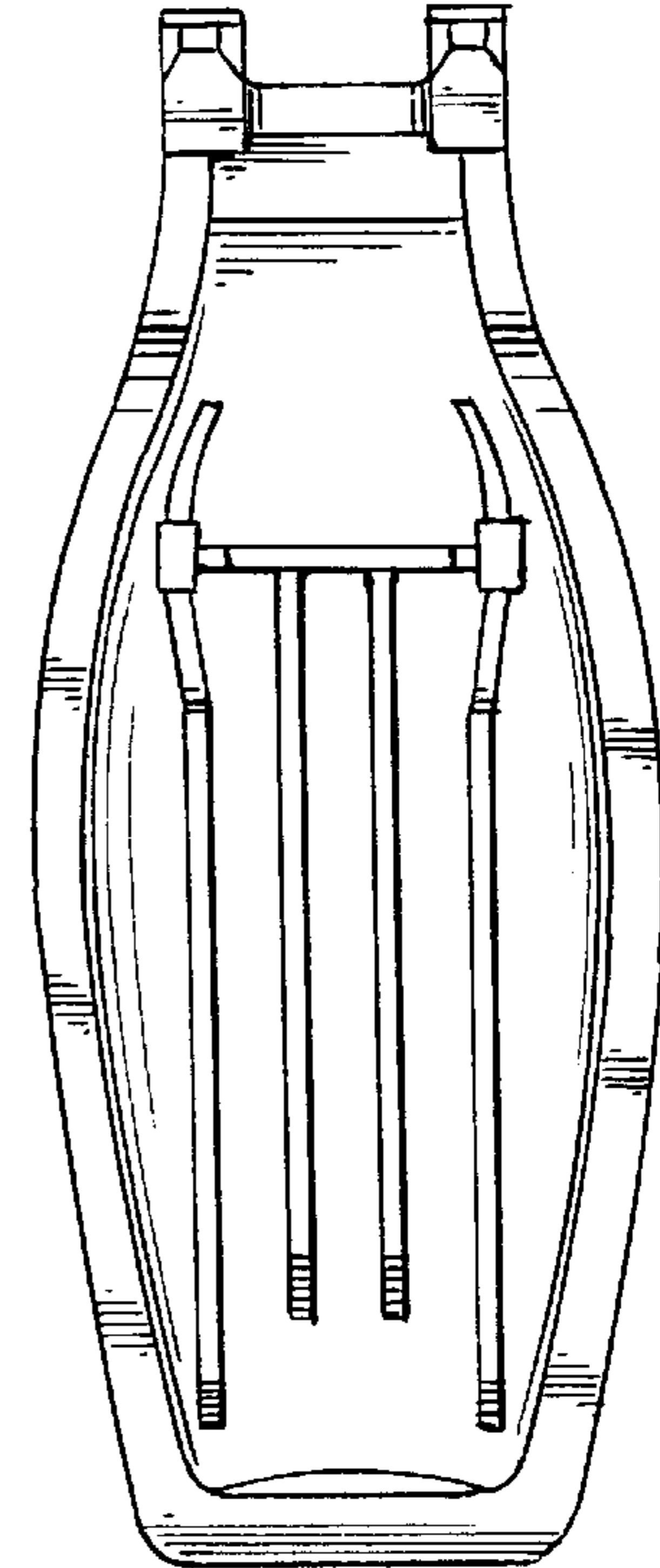

FIG. 10



11 ←

FIG. 11

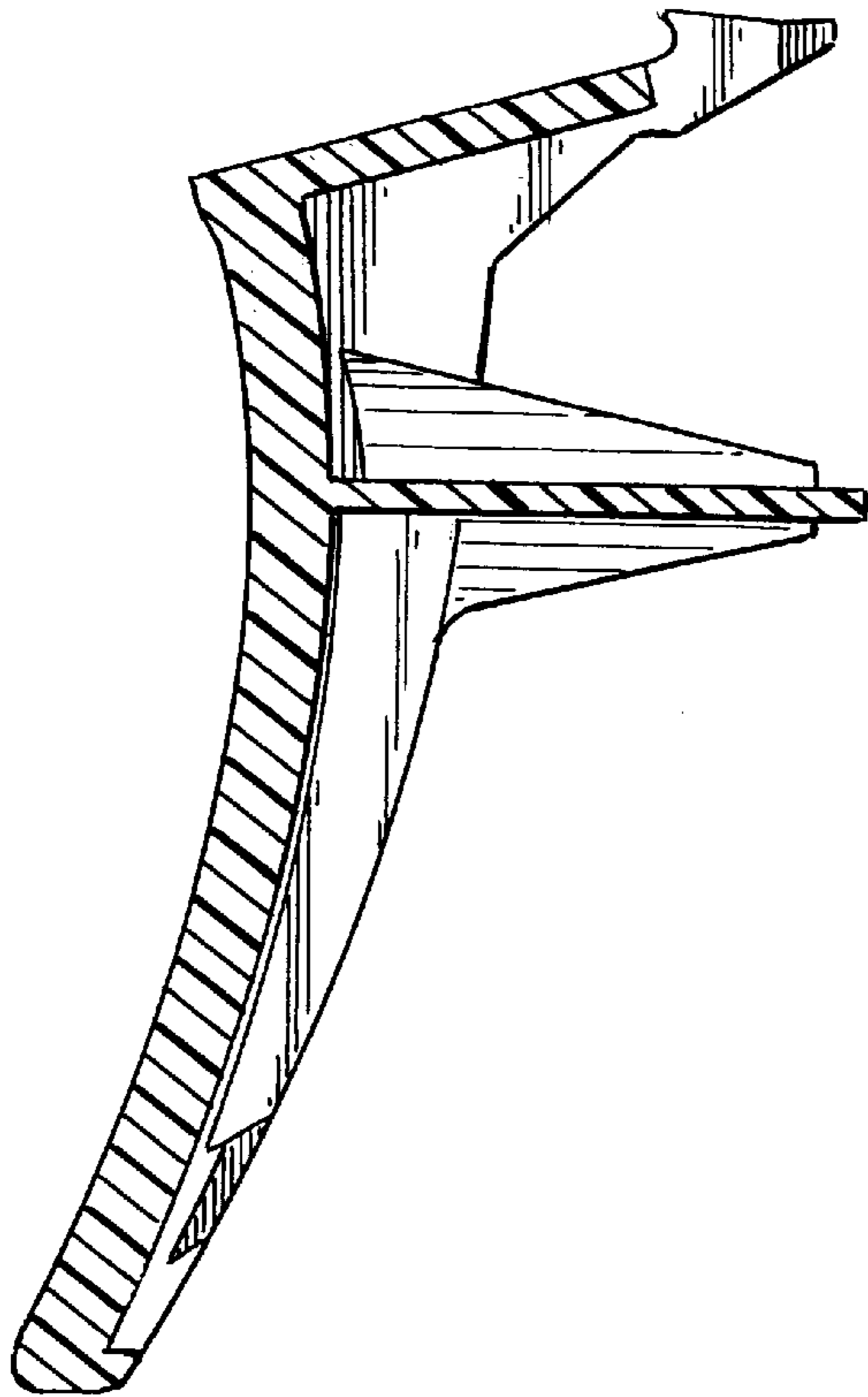

FIG. 12

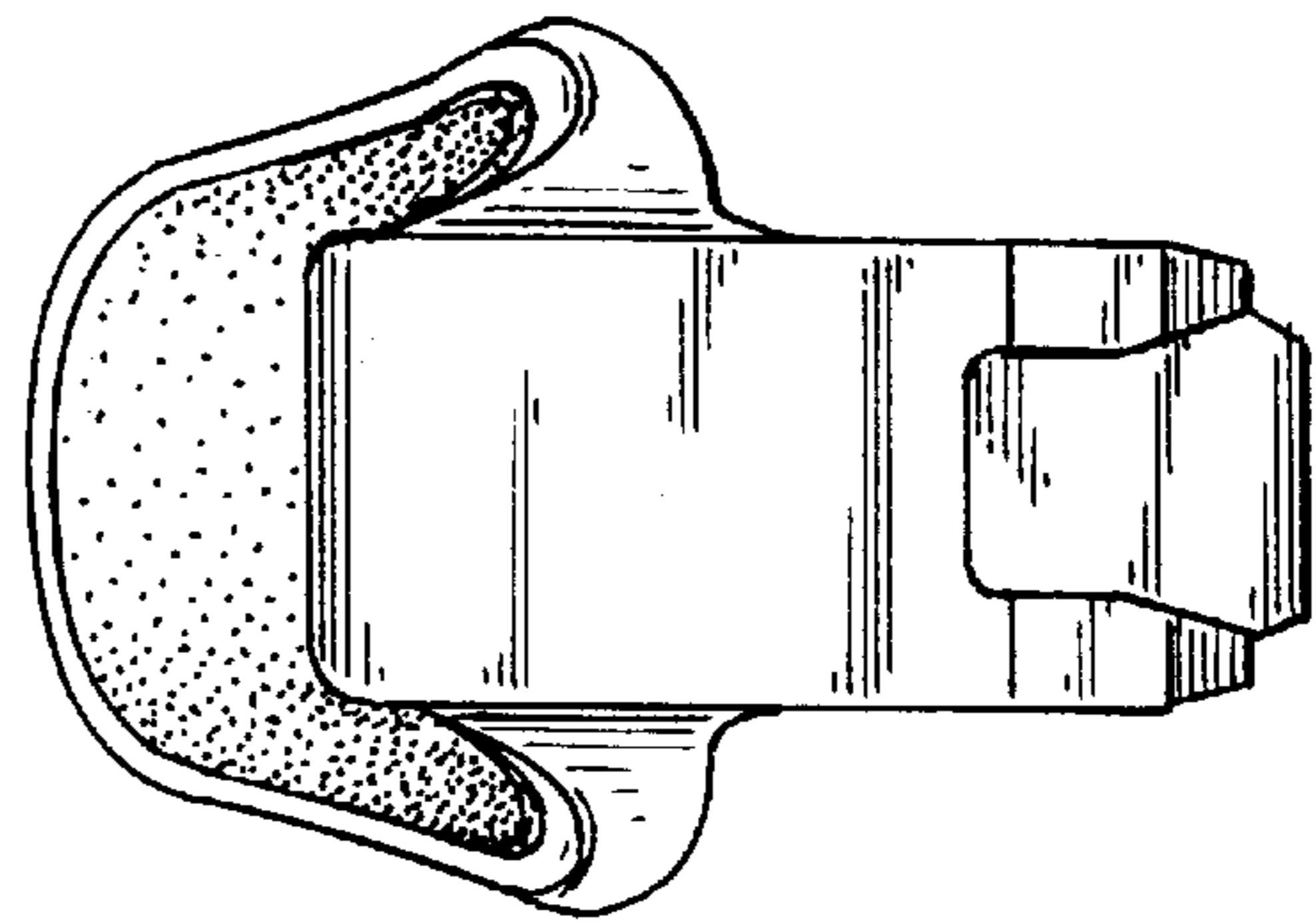

FIG. 13

