



US00D454150S

(12) **United States Design Patent**
Shigemura et al.

(10) **Patent No.:** **US D454,150 S**

(45) **Date of Patent:** **** Mar. 5, 2002**

(54) **CASH REGISTER**

D442,618 S * 5/2001 Tamaki D18/7

* cited by examiner

(75) Inventors: **Atsushi Shigemura**, Tokyo; **Tadahisa Sawano**, Hachioji, both of (JP)

Primary Examiner—Caron D. Veynar

(73) Assignee: **Casio Keisanki Kabushiki Kaisha**, Tokyo (JP)

(74) *Attorney, Agent, or Firm*—Frishauf, Holtz, Goodman, Langer & Chick, P.C.

(**) Term: **14 Years**

(57) **CLAIM**

The ornamental design for a cash register, as shown and described.

(21) Appl. No.: **29/145,991**

DESCRIPTION

(22) Filed: **Aug. 1, 2001**

FIG. 1 is a front elevational view of a cash register, showing our new design;

(51) **LOC (7) Cl.** **18-01**

FIG. 2 is a rear elevational view thereof;

(52) **U.S. Cl.** **D18/4.1**

FIG. 3 is a top plan view thereof;

(58) **Field of Search** D18/1-12; 705/15, 705/16, 17; 235/7 R

FIG. 4 is a bottom plan view thereof;

FIG. 5 is a right side elevational view thereof;

FIG. 6 is a left side elevational view thereof;

FIG. 7 is a right side elevational view thereof showing a state in which a display section is drawn; and,

FIG. 8 is a rear elevational view thereof showing the state in which the display section is drawn.

(56) **References Cited**

U.S. PATENT DOCUMENTS

D379,366 S * 5/1997 Hokazono D18/4.1

D429,757 S * 8/2000 Yatabe D18/4.1

D429,758 S * 8/2000 Komuta et al. D18/4.1

1 Claim, 4 Drawing Sheets

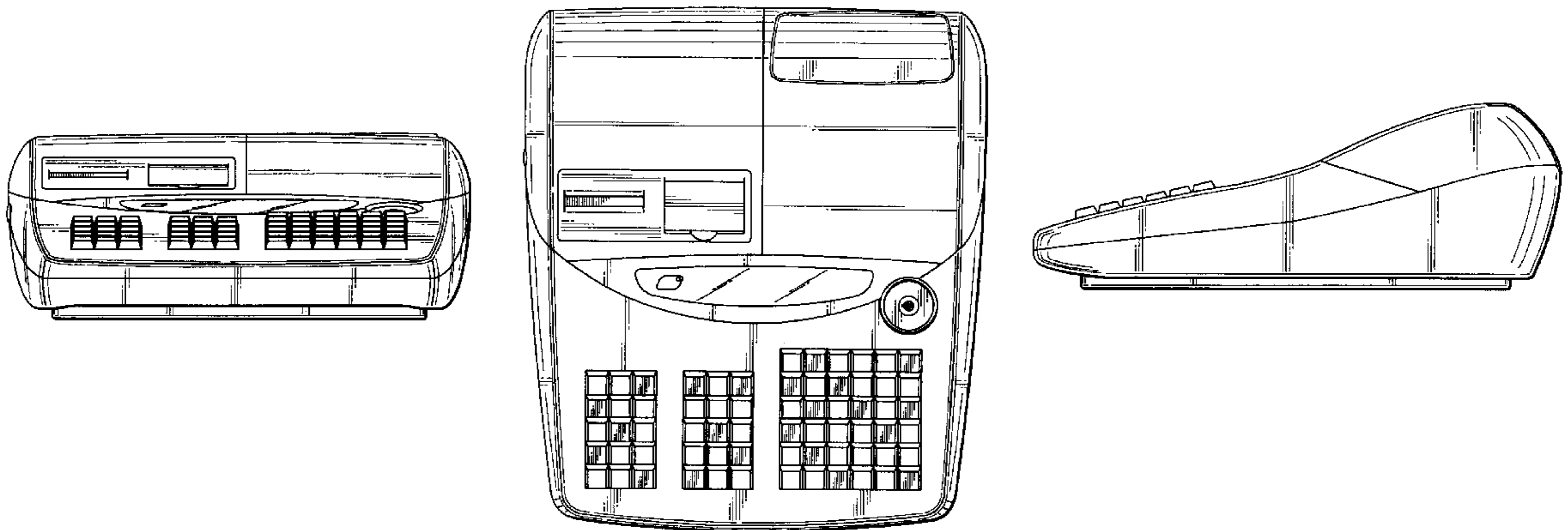

FIG. 1

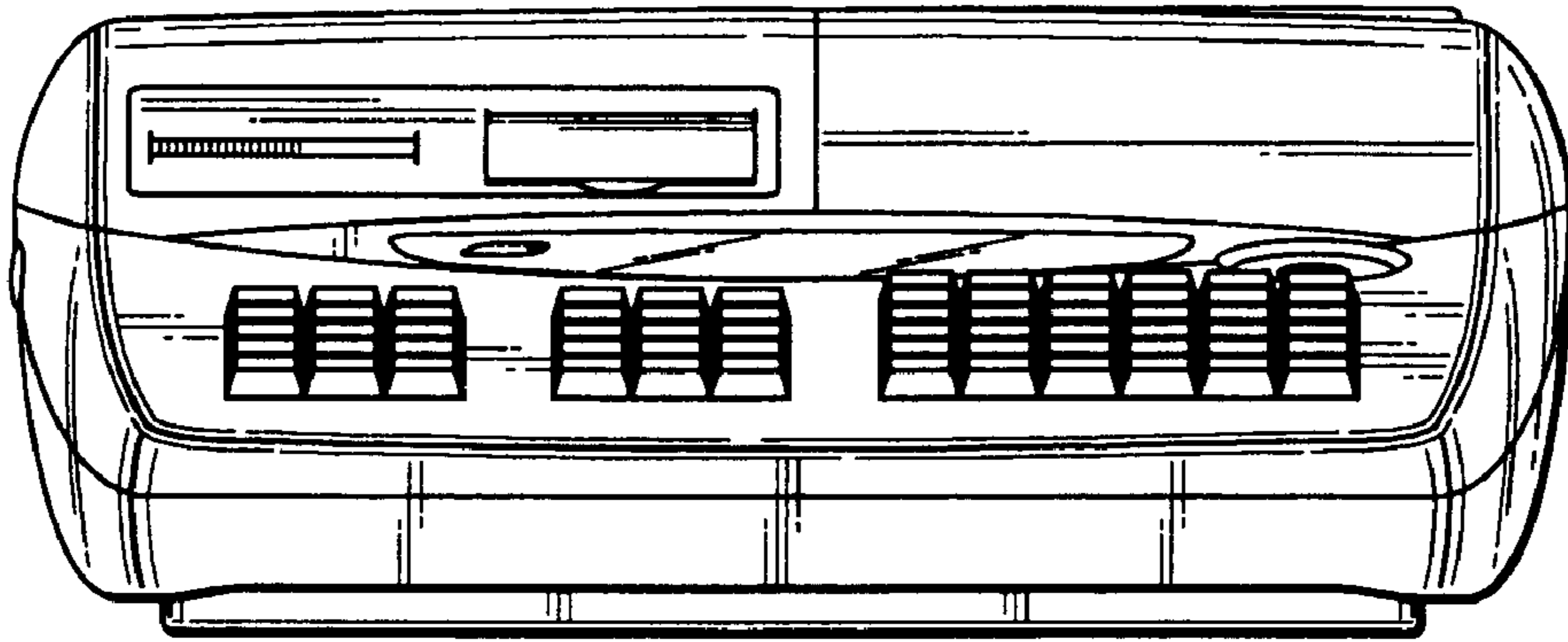

FIG. 2

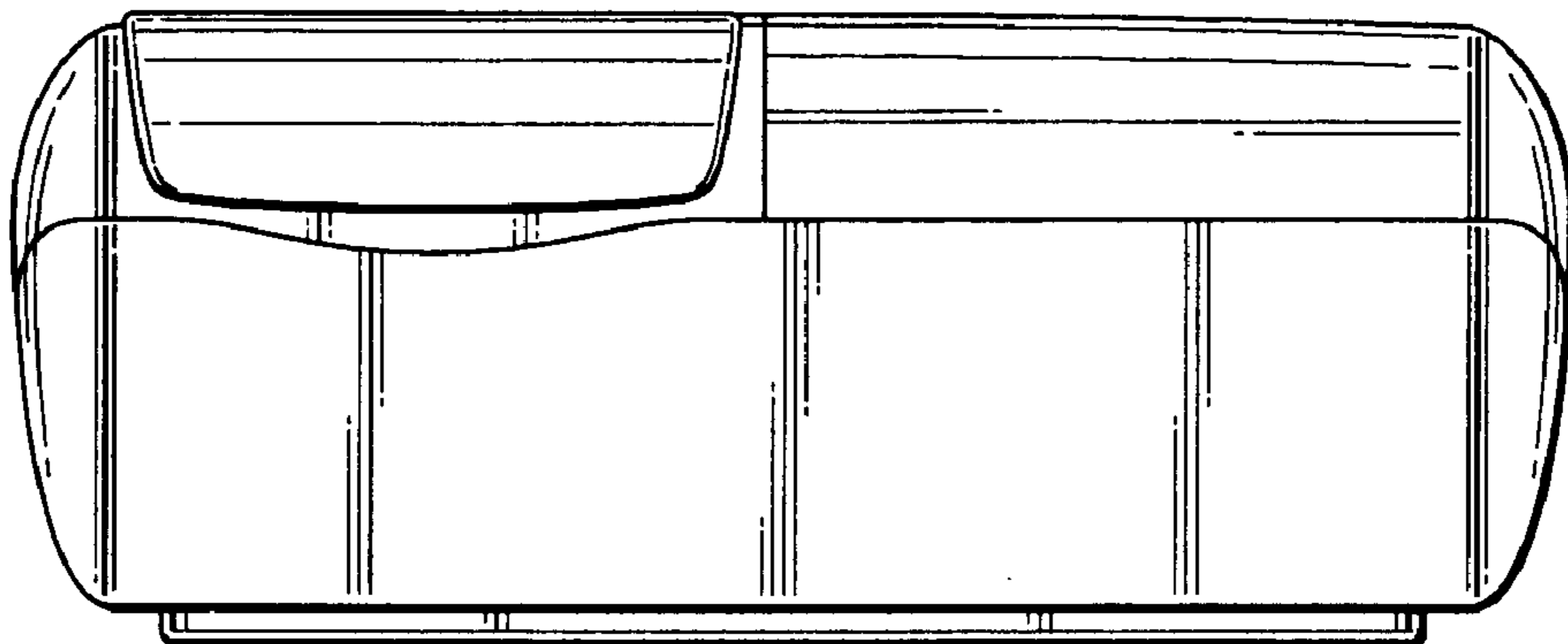

FIG.3

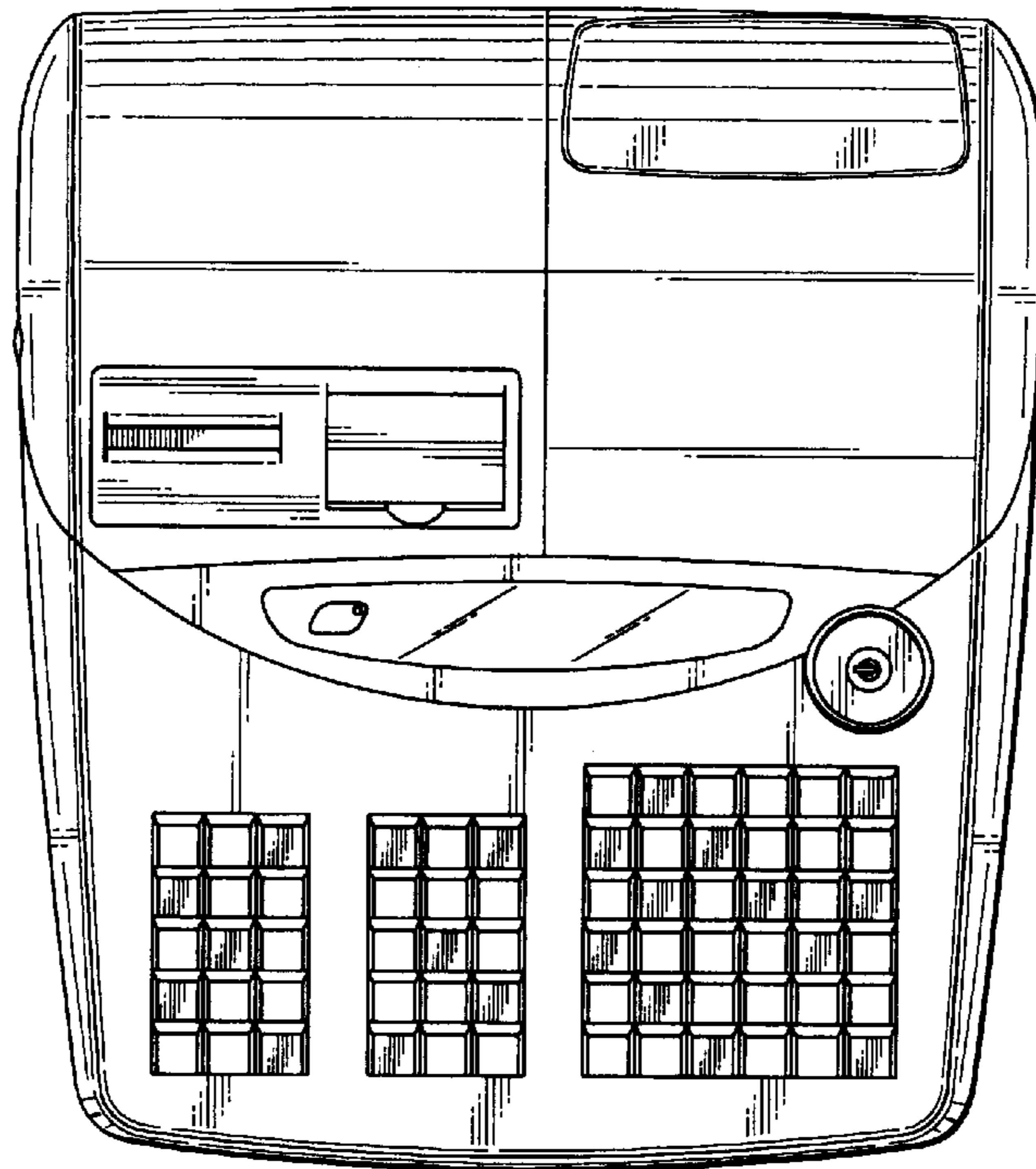

FIG.4

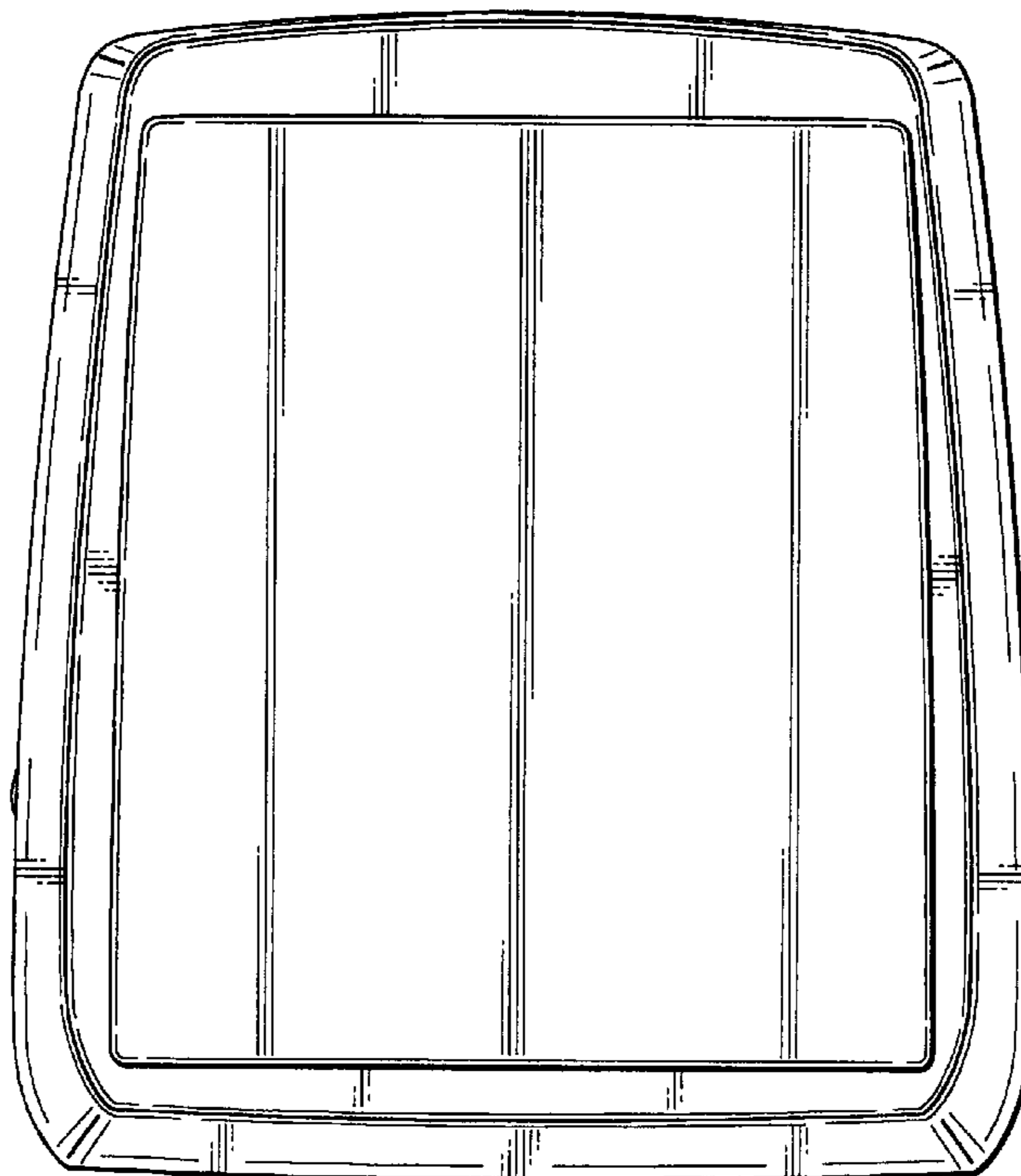

FIG. 5

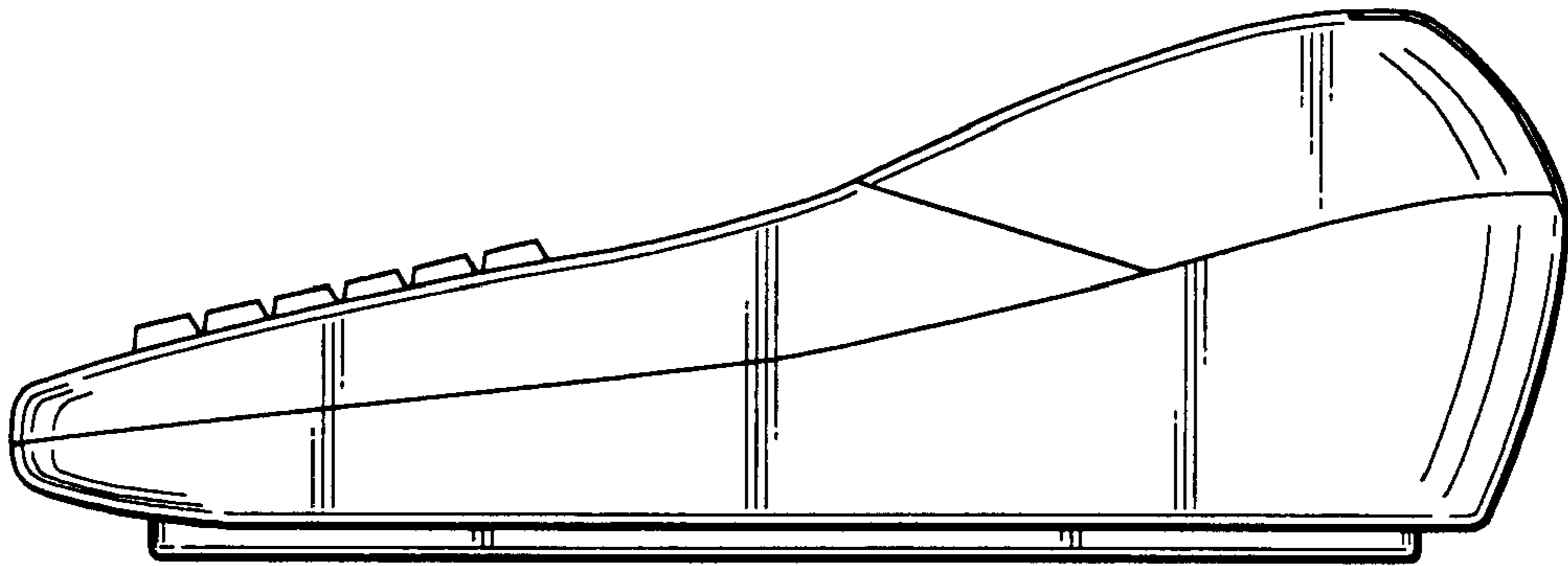

FIG. 6

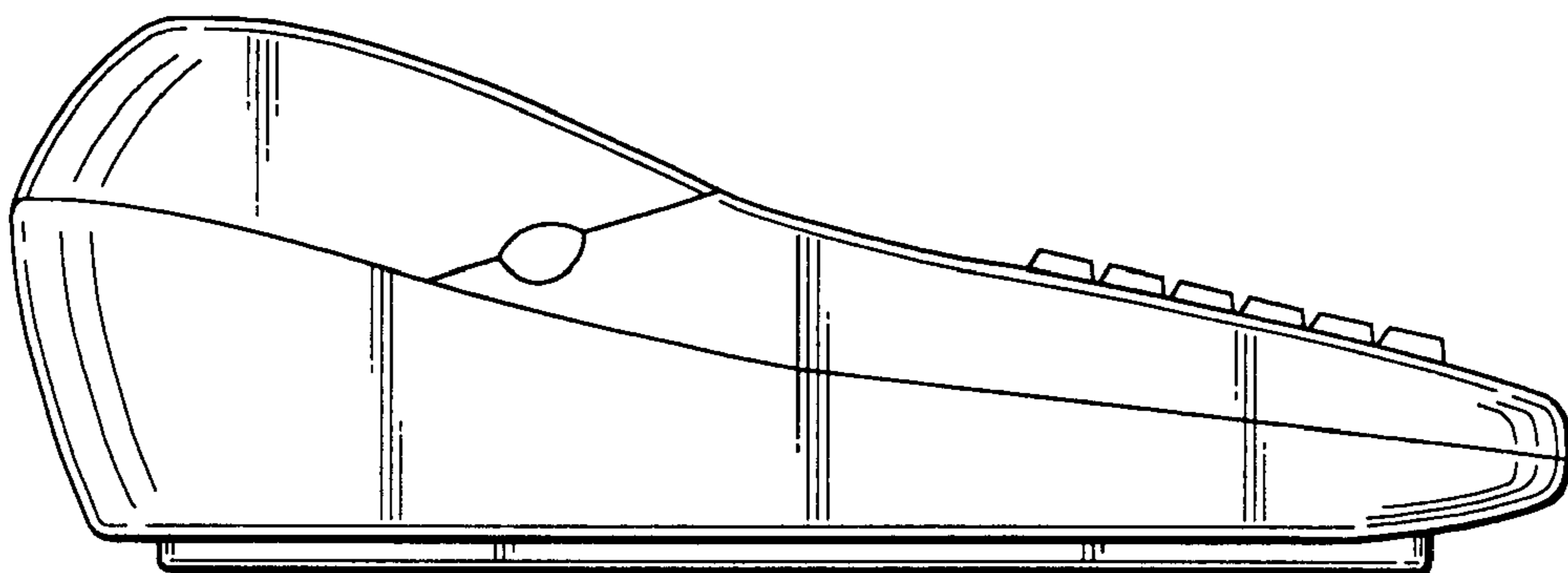

FIG. 7

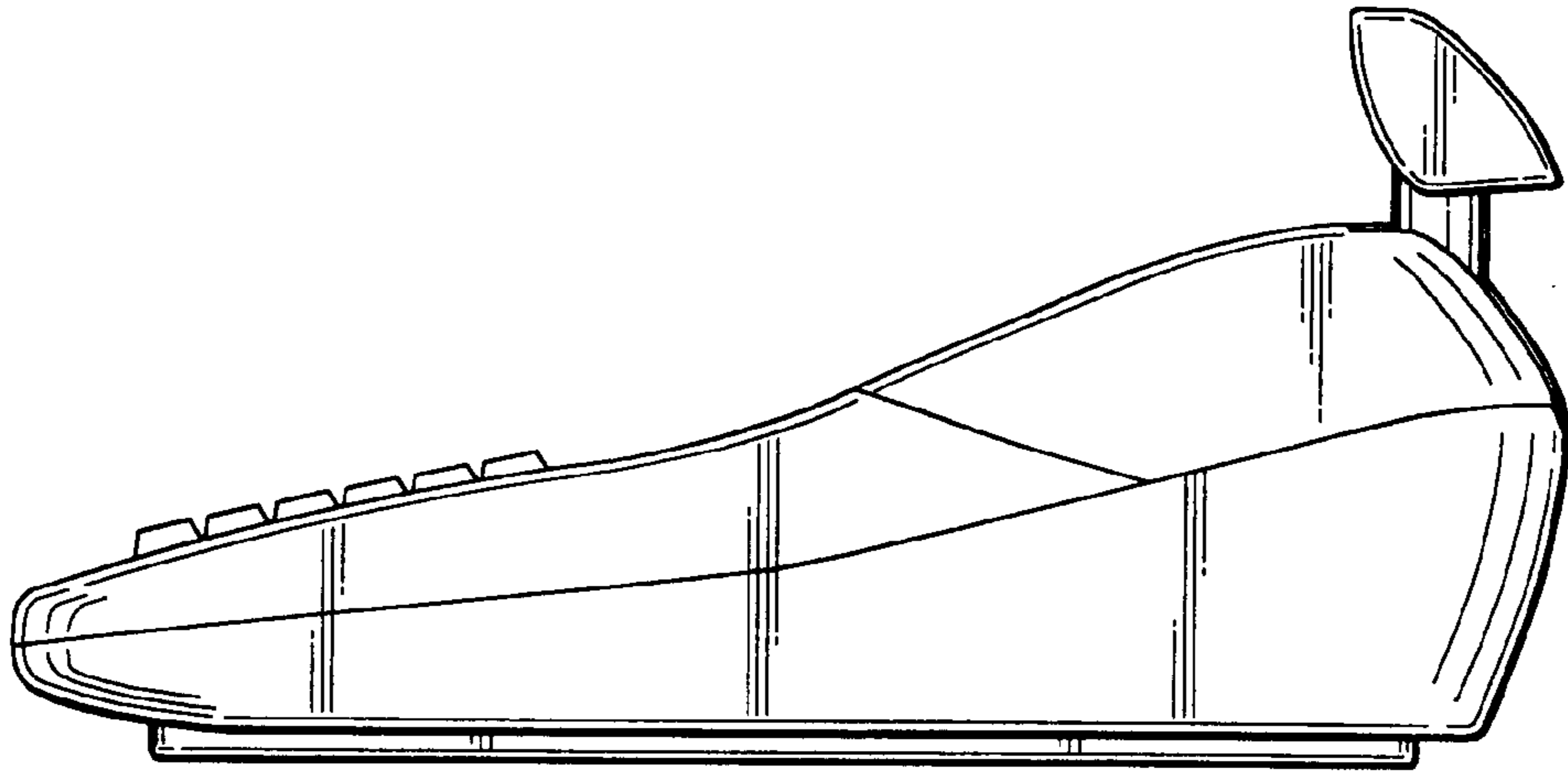

FIG. 8

