



US00D454036S

(12) **United States Design Patent**
Tse

(10) **Patent No.:** **US D454,036 S**

(45) **Date of Patent:** **** Mar. 5, 2002**

(54) **NUT CRACKER**

2,379,121 A * 6/1945 Via 30/120.3

(75) **Inventor:** **Kwok Kay Tse, Kowloon (CN)**

* cited by examiner

(73) **Assignee:** **ISIS Technology Limited, Kowloon (CN)**

Primary Examiner—Terry A. Wallace

(74) *Attorney, Agent, or Firm*—Alix, Yale & Ristas, LLP

(**) **Term:** **14 Years**

(57) **CLAIM**

The ornamental design for a nut cracker, as shown and described.

(21) **Appl. No.:** **29/138,807**

(22) **Filed:** **Mar. 20, 2001**

DESCRIPTION

(51) **LOC (7) Cl.** **07-06**

FIG. 1 is a front perspective view of the nut cracker showing my new design;

(52) **U.S. Cl.** **D7/680**

FIG. 2 is a front view of the nut cracker of FIG. 1;

(58) **Field of Search** D7/680; 30/120.1–120.5; 99/580, 581; 100/234; D8/51, 52, 55

FIG. 3 is a left side view of the nut cracker of FIG. 1;

FIG. 4 is a top plan view of the nut cracker of FIG. 1;

FIG. 5 is a rear view of the nut cracker of FIG. 1;

FIG. 6 is a right side view of the nut cracker of FIG. 1; and,

FIG. 7 is a bottom plan view of the nut cracker of FIG. 1.

(56) **References Cited**

U.S. PATENT DOCUMENTS

508,355 A * 11/1893 Streeter et al. 30/120.3

660,763 A * 10/1900 Thompson 30/120.3

1 Claim, 3 Drawing Sheets

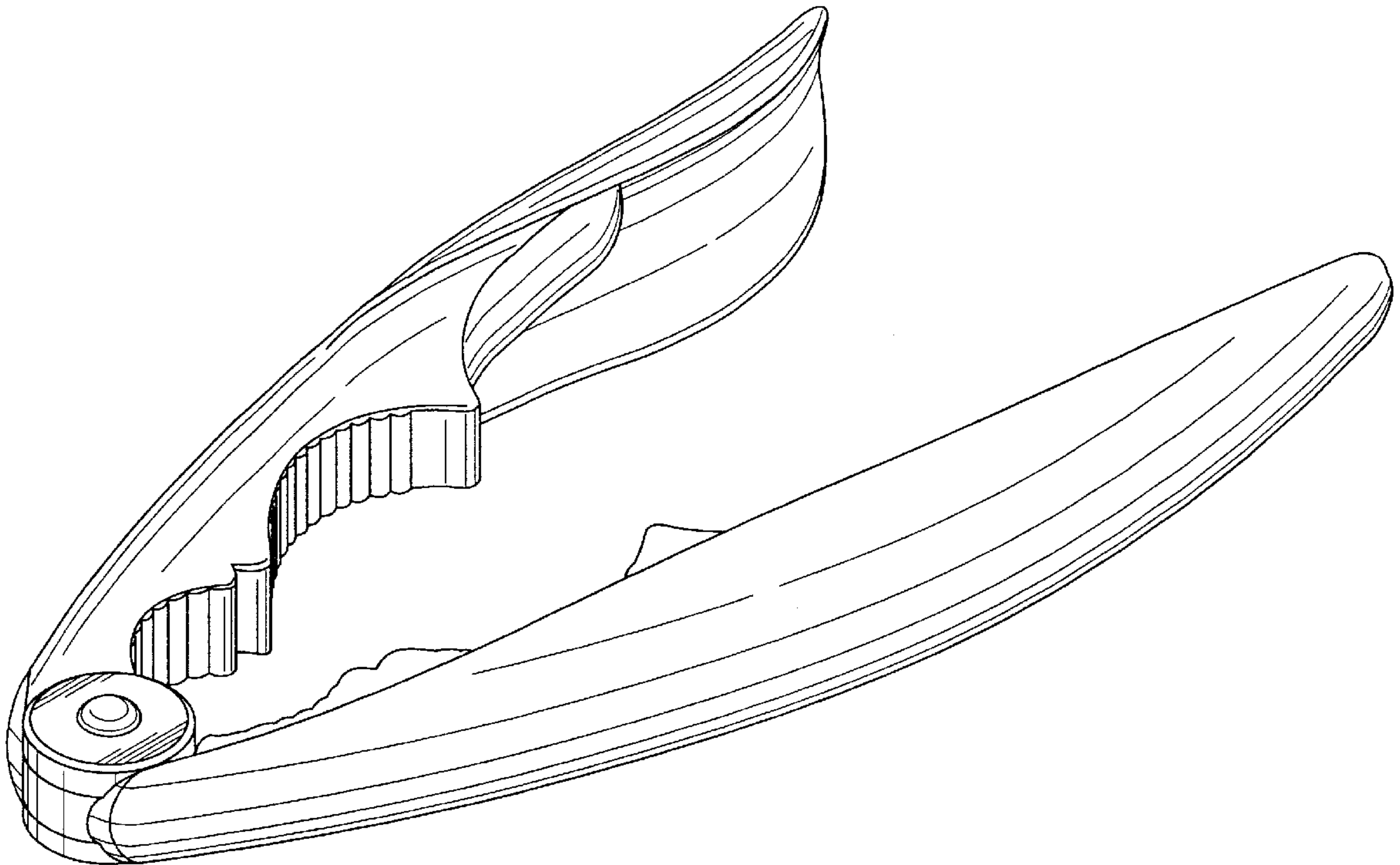

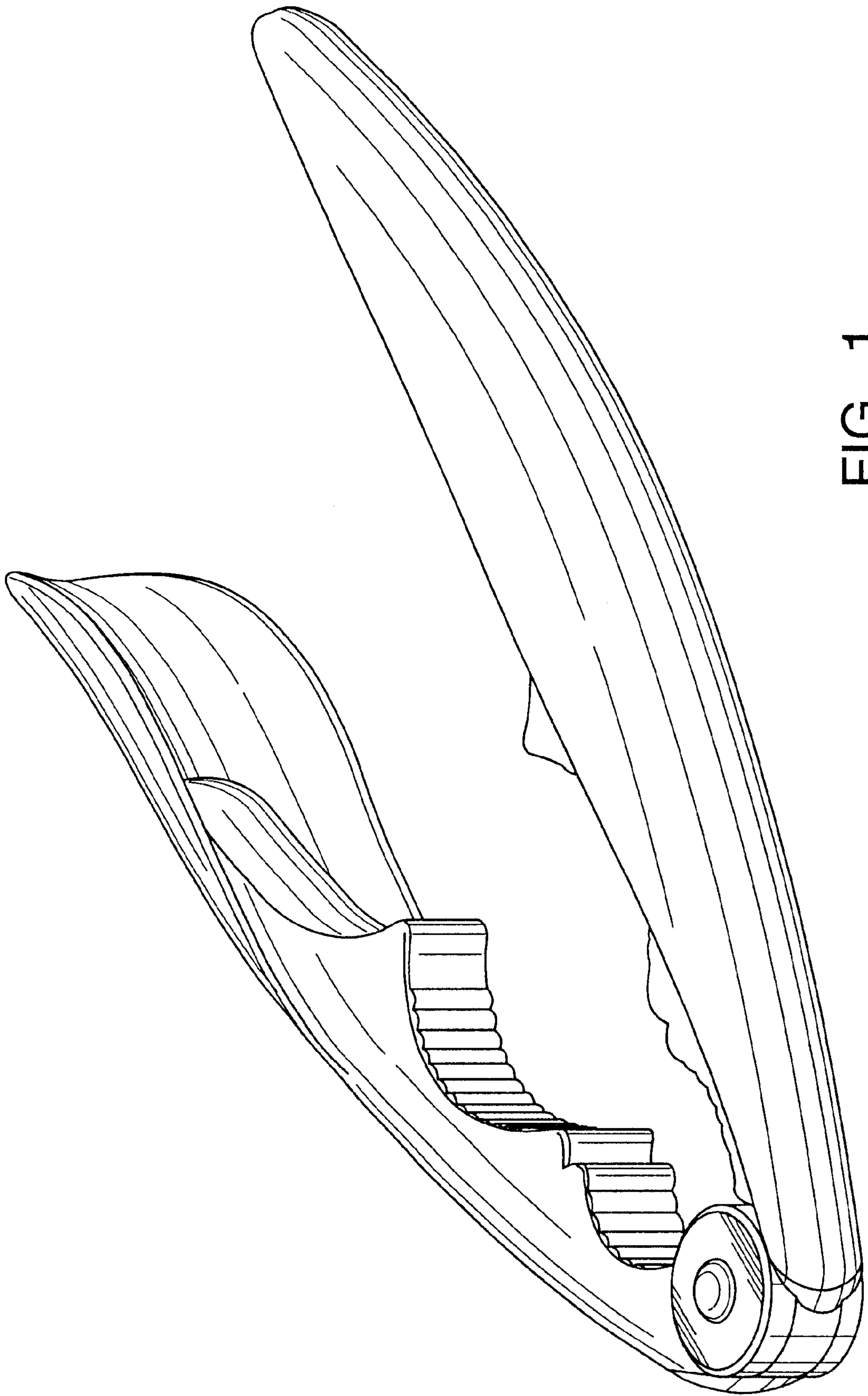

FIG. 1

FIG. 4

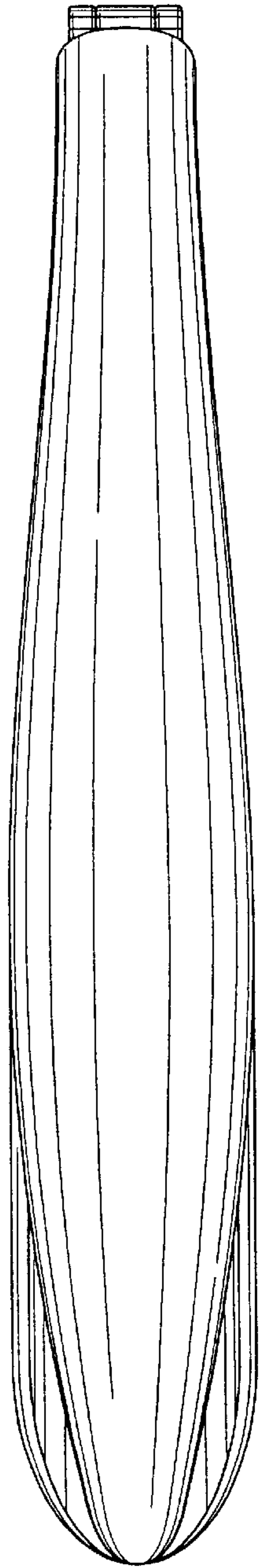
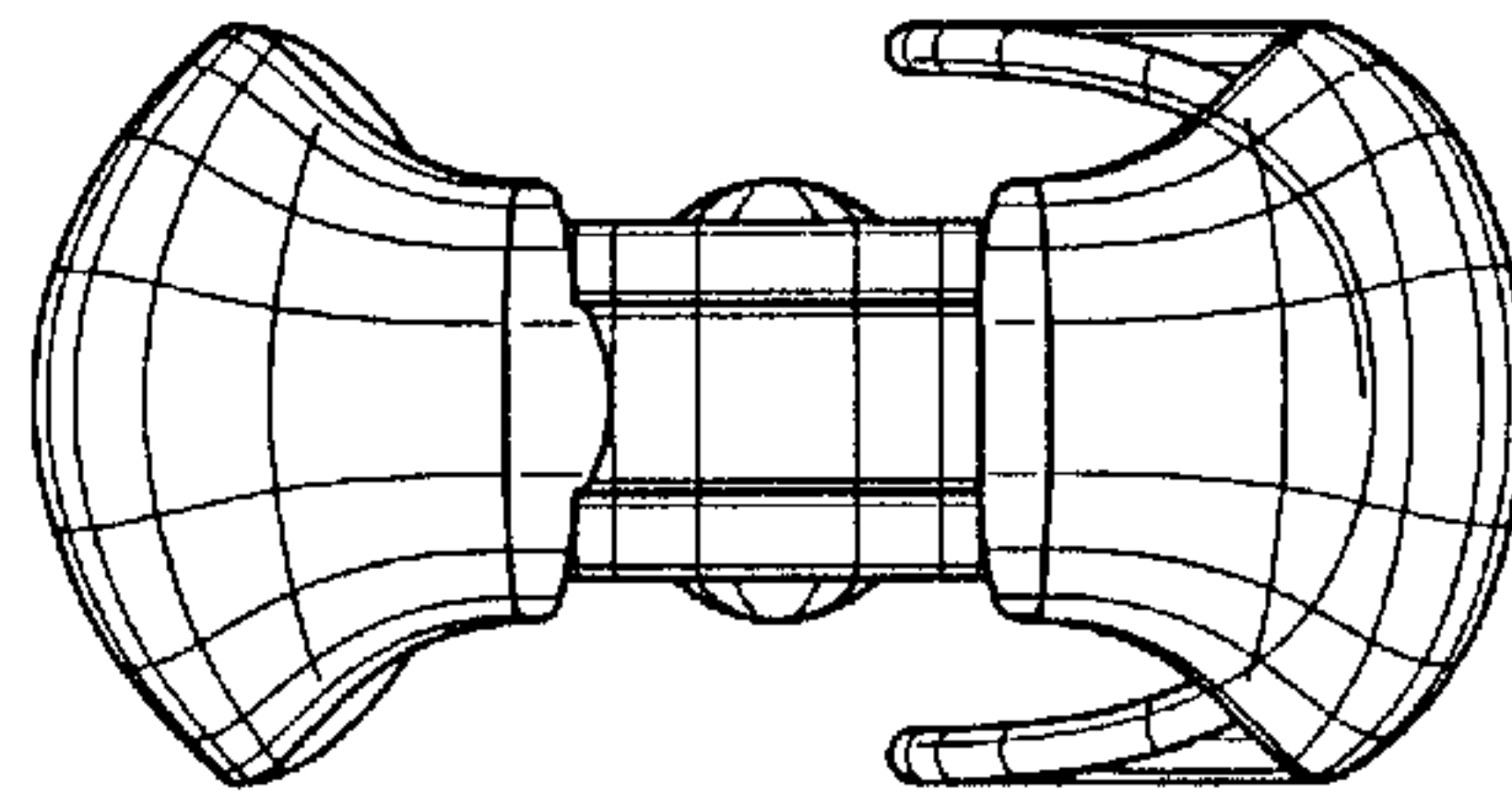

FIG. 3

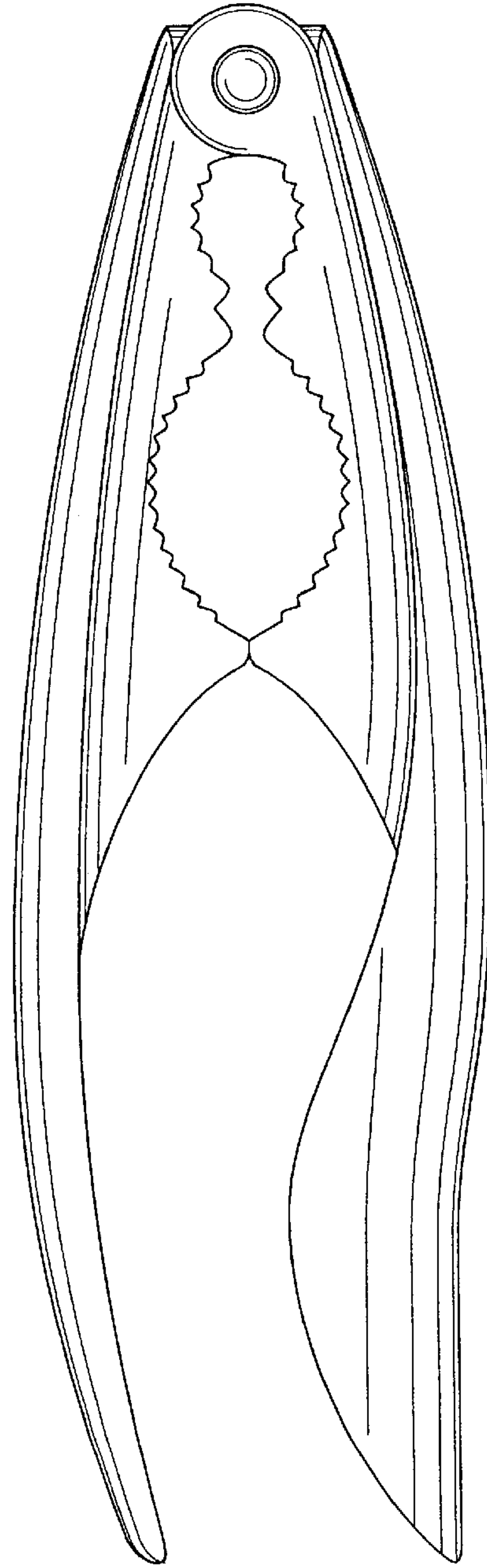

FIG. 2

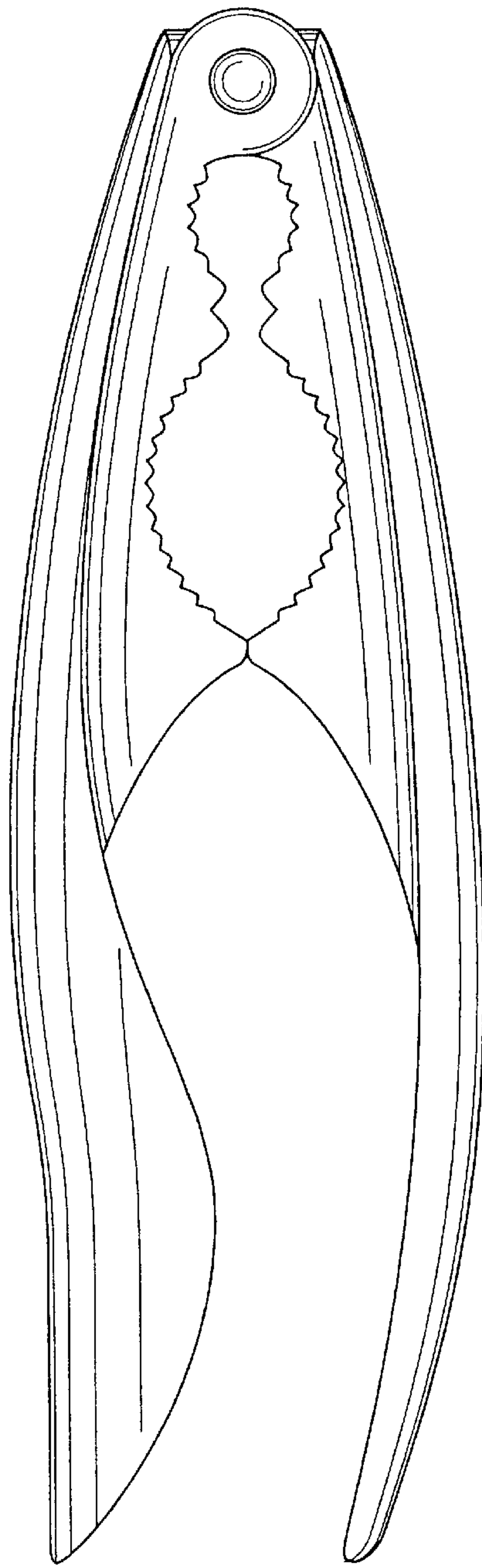

FIG. 5

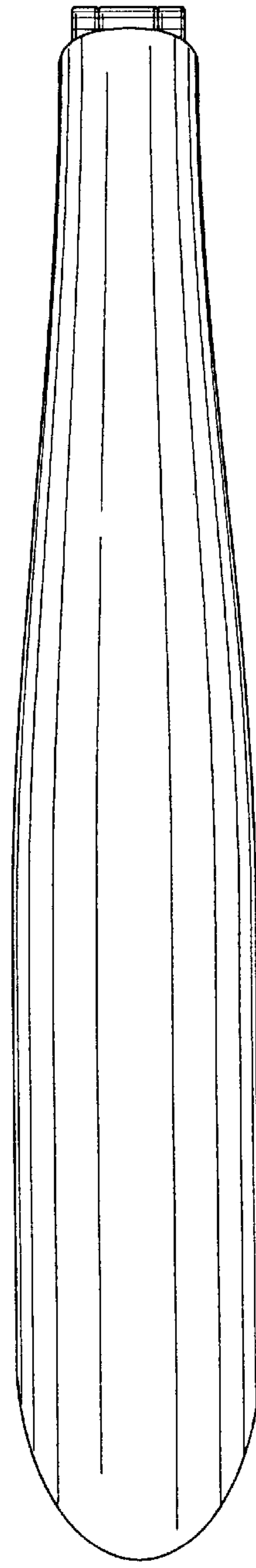

FIG. 6

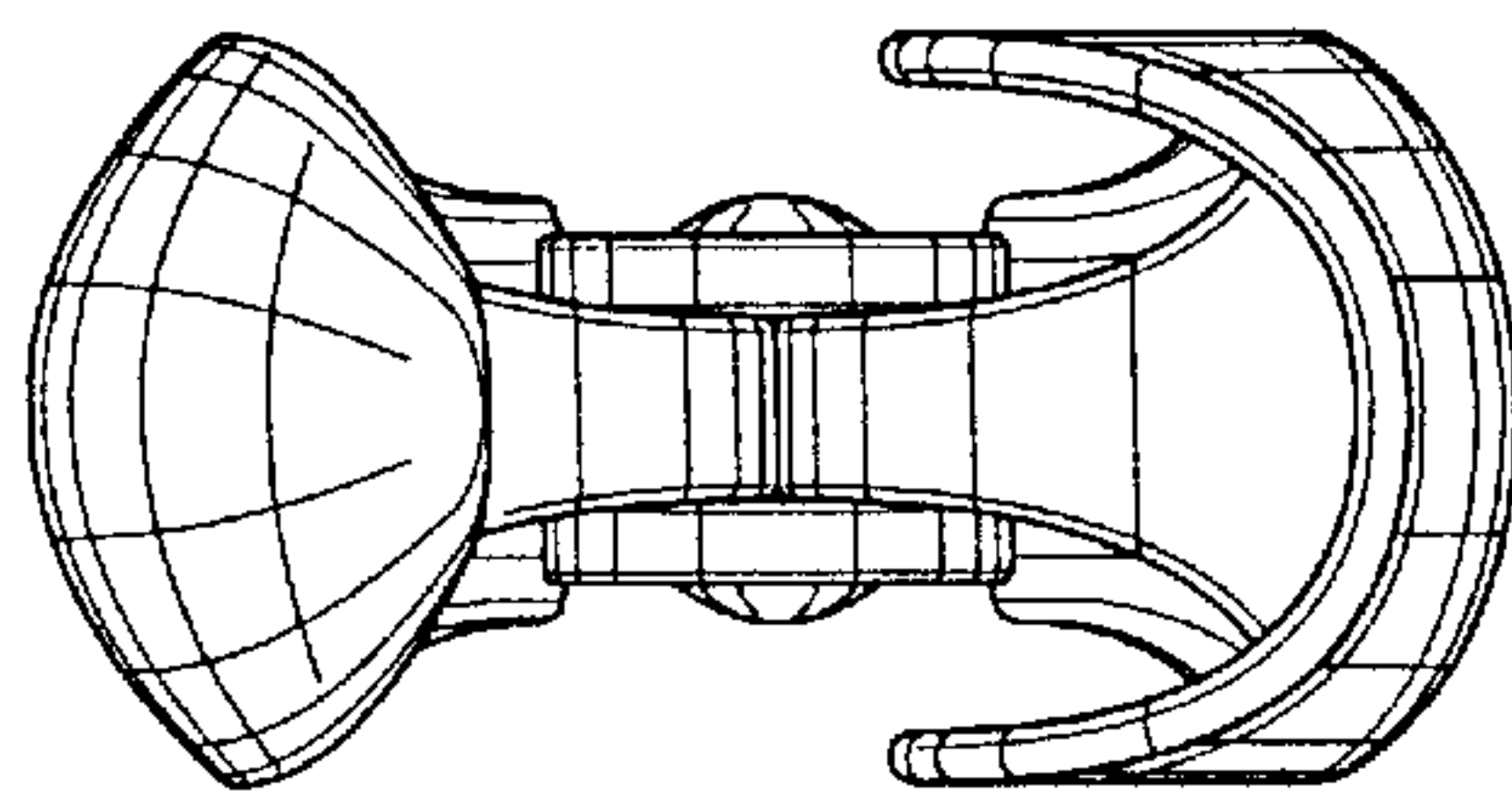

FIG. 7