



US00D453901S

(12) **United States Design Patent**
Shepperson

(10) **Patent No.:** **US D453,901 S**

(45) **Date of Patent:** **** Feb. 26, 2002**

(54) **CLAMSHELL PACKAGING FOR SAFETY RAZOR**

(75) **Inventor:** **Ian Raymond Shepperson, Ripley (GB)**

(73) **Assignee:** **American Safety Razor Company, Verona, VA (US)**

(**) **Term:** **14 Years**

(21) **Appl. No.:** **29/124,197**

(22) **Filed:** **Jun. 1, 2000**

(51) **LOC (7) Cl.** **09-01**

(52) **U.S. Cl.** **D9/418; D9/415**

(58) **Field of Search** **D9/341, 345, 347, D9/415, 418; 206/352, 461, 467, 469, 470, 471**

(56) **References Cited**

U.S. PATENT DOCUMENTS

2,822,916	A	*	2/1958	Wark et al.	206/228
D250,092	S	*	10/1978	Schoenfield et al.	D9/437
4,191,293	A	*	3/1980	Newman	206/467
D305,408	S	*	1/1990	LaJoie	D9/415
D327,844	S	*	7/1992	Wimbish et al.	D9/415
D329,600	S	*	9/1992	LaJoie	D9/418

D342,446	S	*	12/1993	Parker	D9/415
D352,236	S	*	11/1994	Althaus	D9/415
5,429,241	A	*	7/1995	Althaus	206/471
D395,820	S	*	7/1998	Motta	D9/415
D432,410	S	*	10/2000	Schwartz	D9/415
D442,857	S	*	5/2001	Feehan, Jr.	D9/415
6,276,529	B1	*	8/2001	Feehan, Jr.	206/469

* cited by examiner

Primary Examiner—Ted Shooman

Assistant Examiner—Selina Sikder

(74) *Attorney, Agent, or Firm*—McDermott, Will & Emery

(57) **CLAIM**

The ornamental design for a clamshell packaging for safety razor, as shown and described.

DESCRIPTION

FIG. 1 is a front perspective view of a clamshell packaging for safety razor showing my new design;
FIG. 2 is a rear end view thereof;
FIG. 3 is a front view thereof;
FIG. 4 is a left side elevational view thereof;
FIG. 5 is a right side elevational view thereof;
FIG. 6 is a bottom plan view thereof; and,
FIG. 7 is a top plan view thereof.

1 Claim, 6 Drawing Sheets

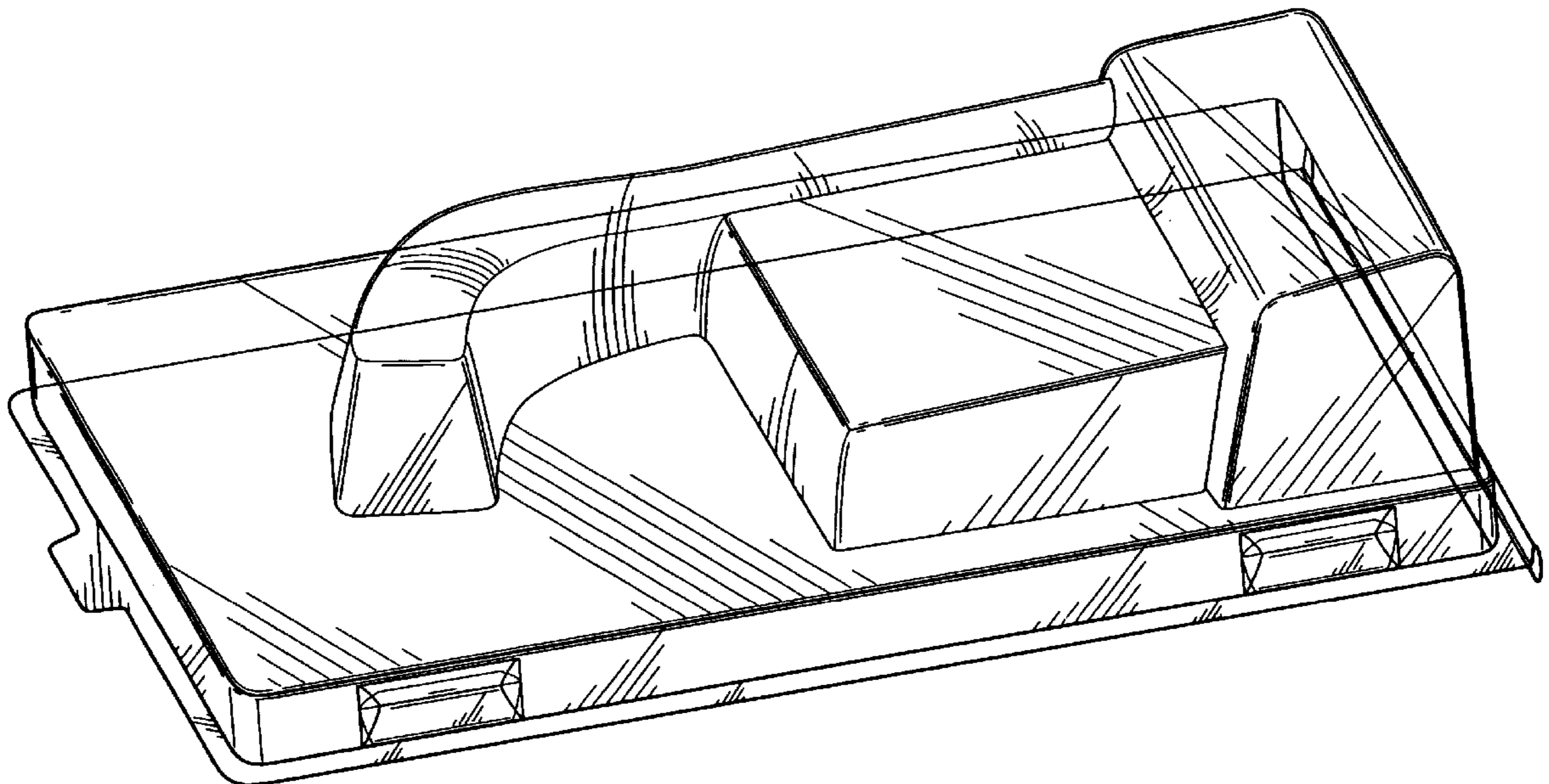

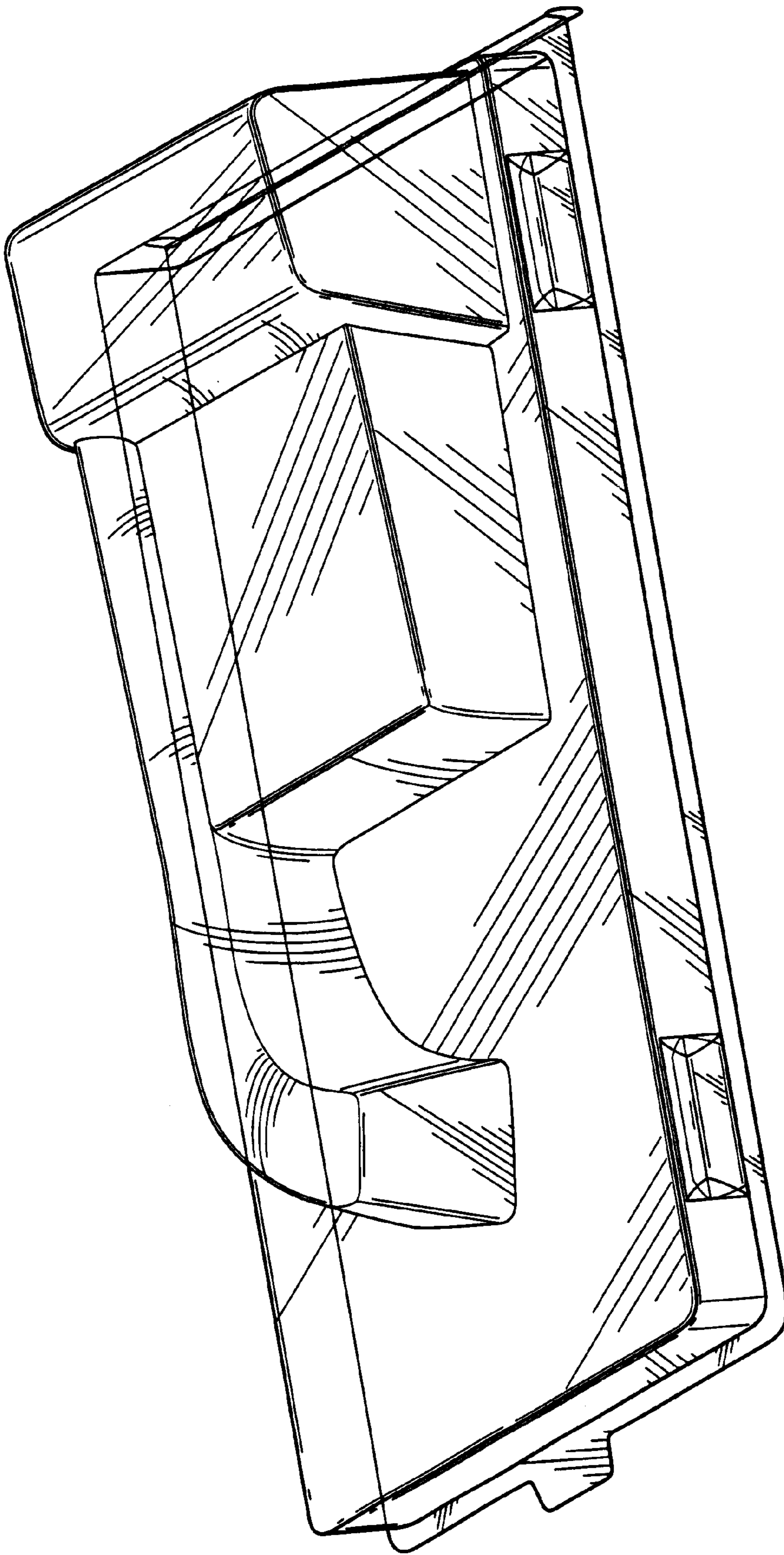

FIG. 1

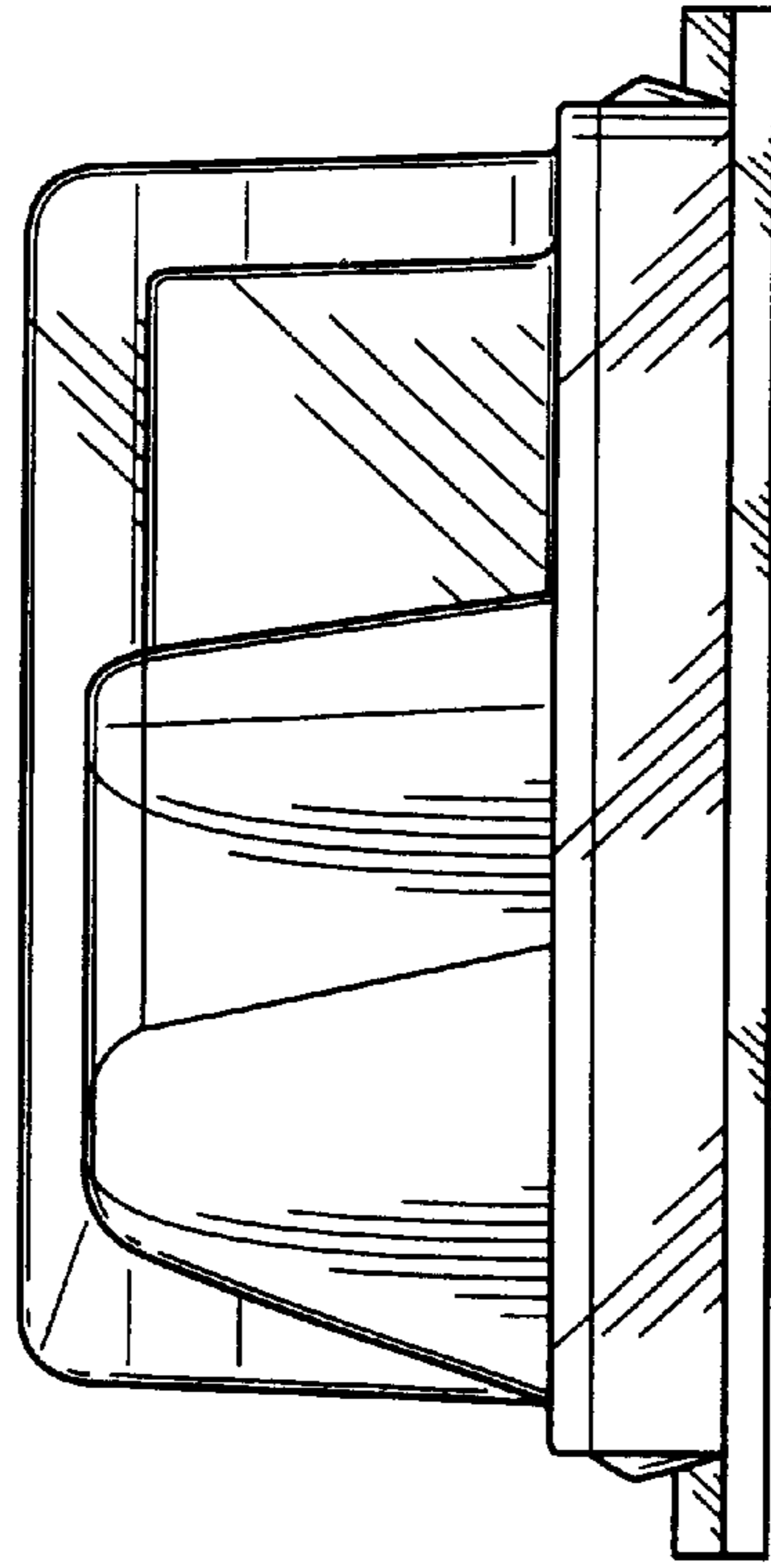

FIG. 3

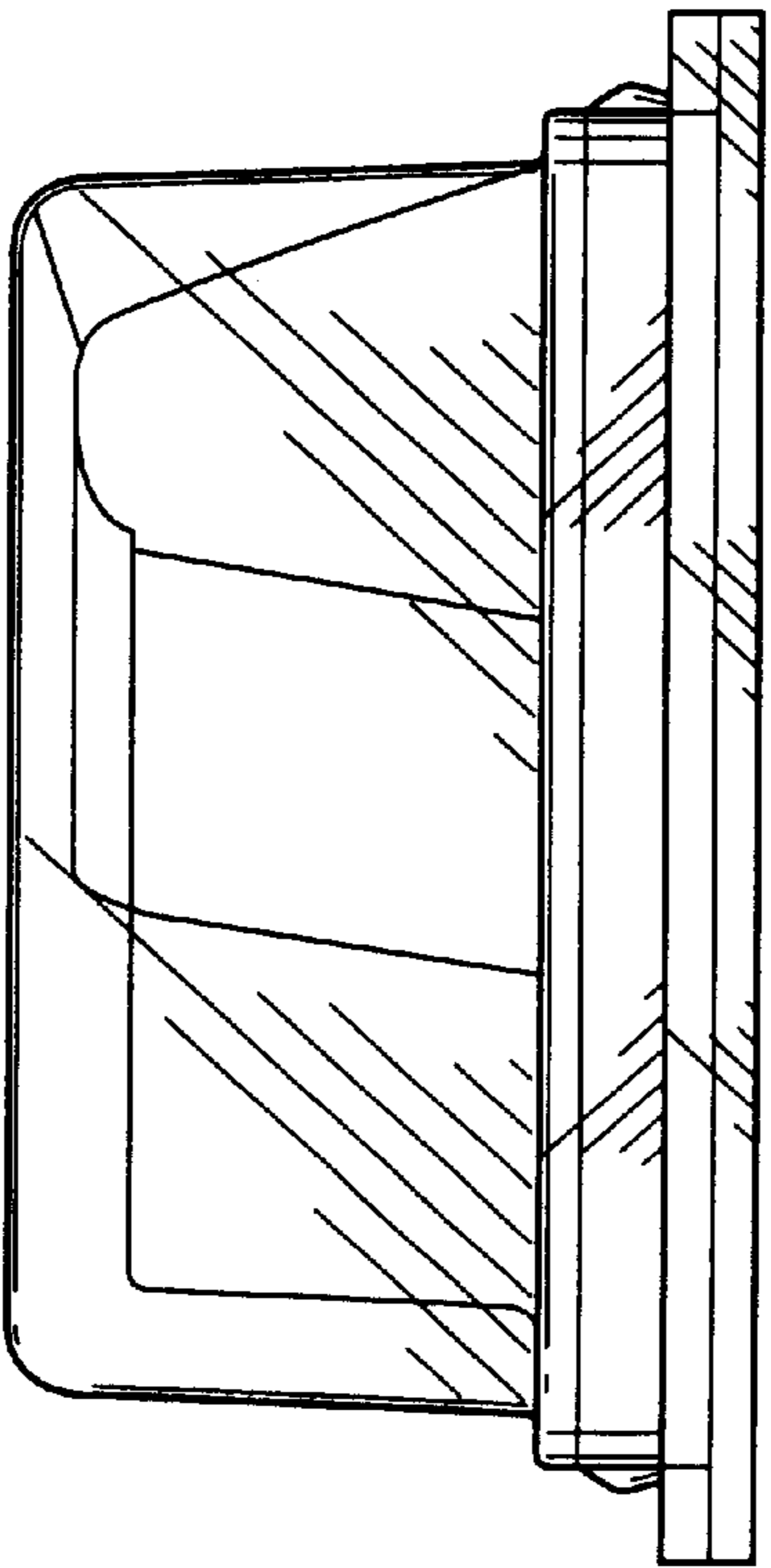

FIG. 2

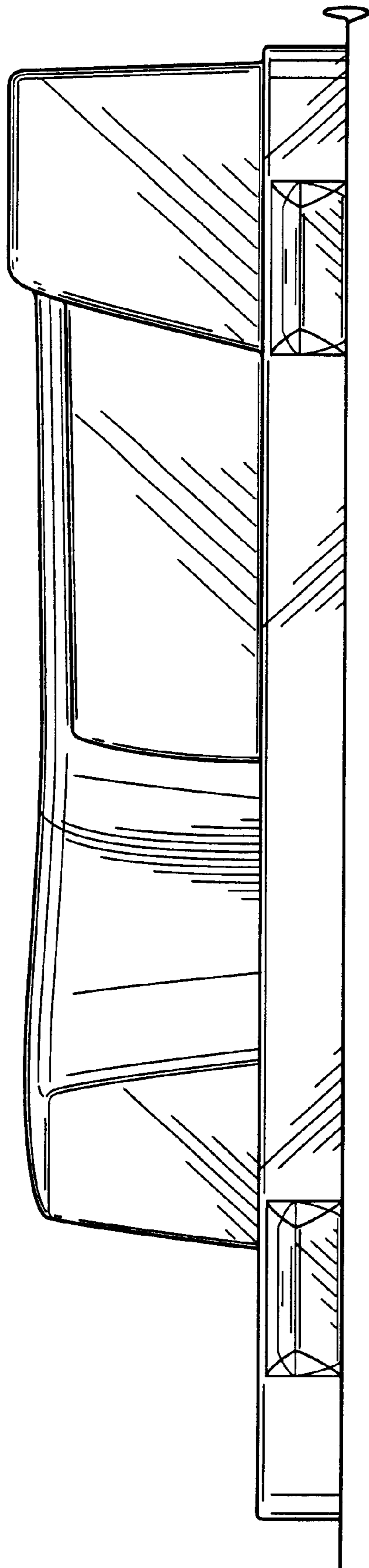

FIG. 4

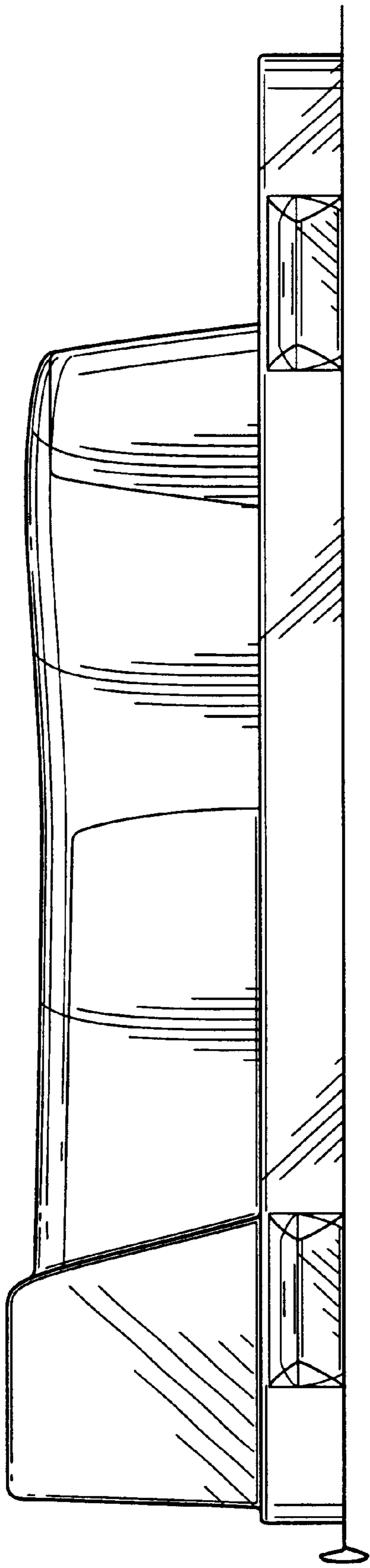

FIG. 5

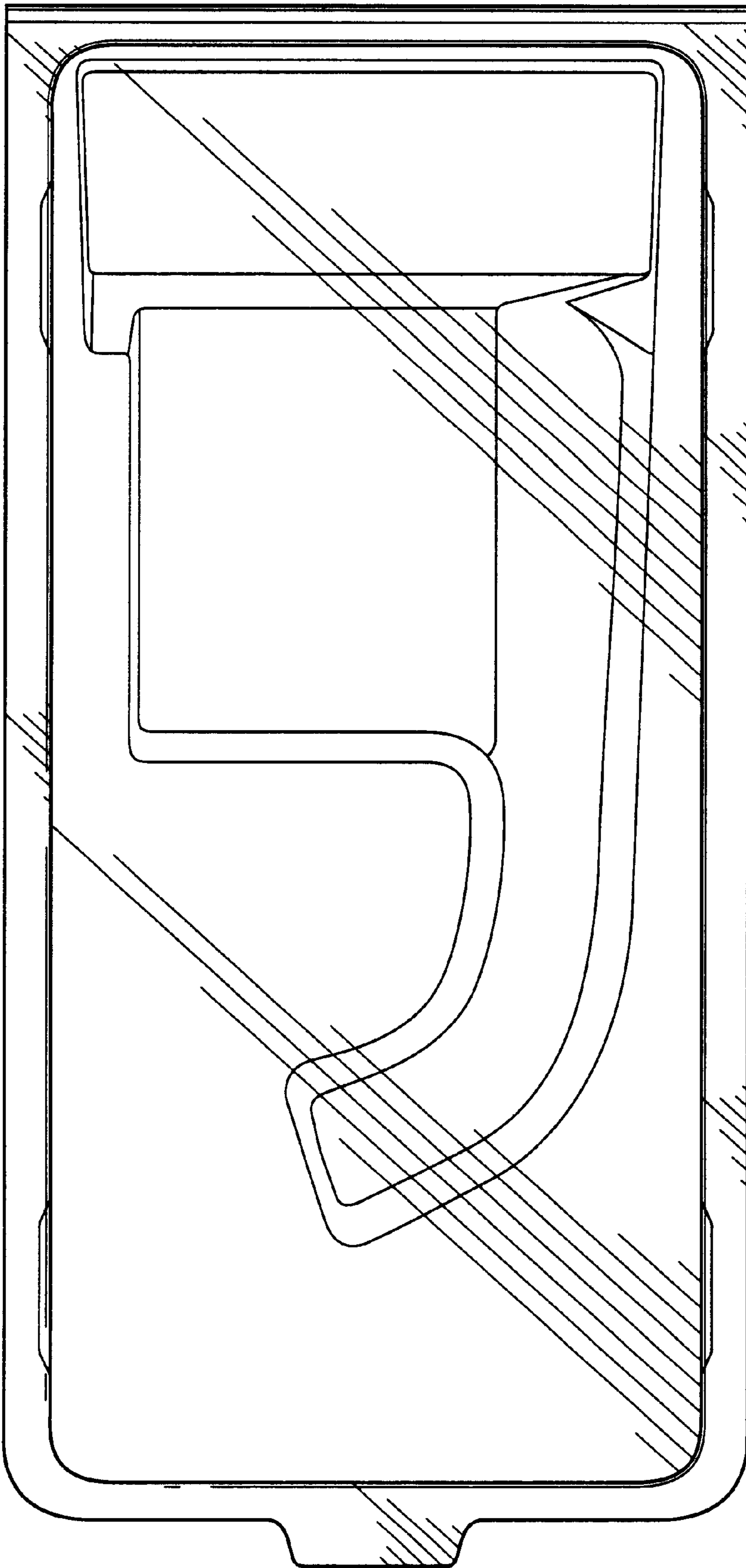

FIG. 6

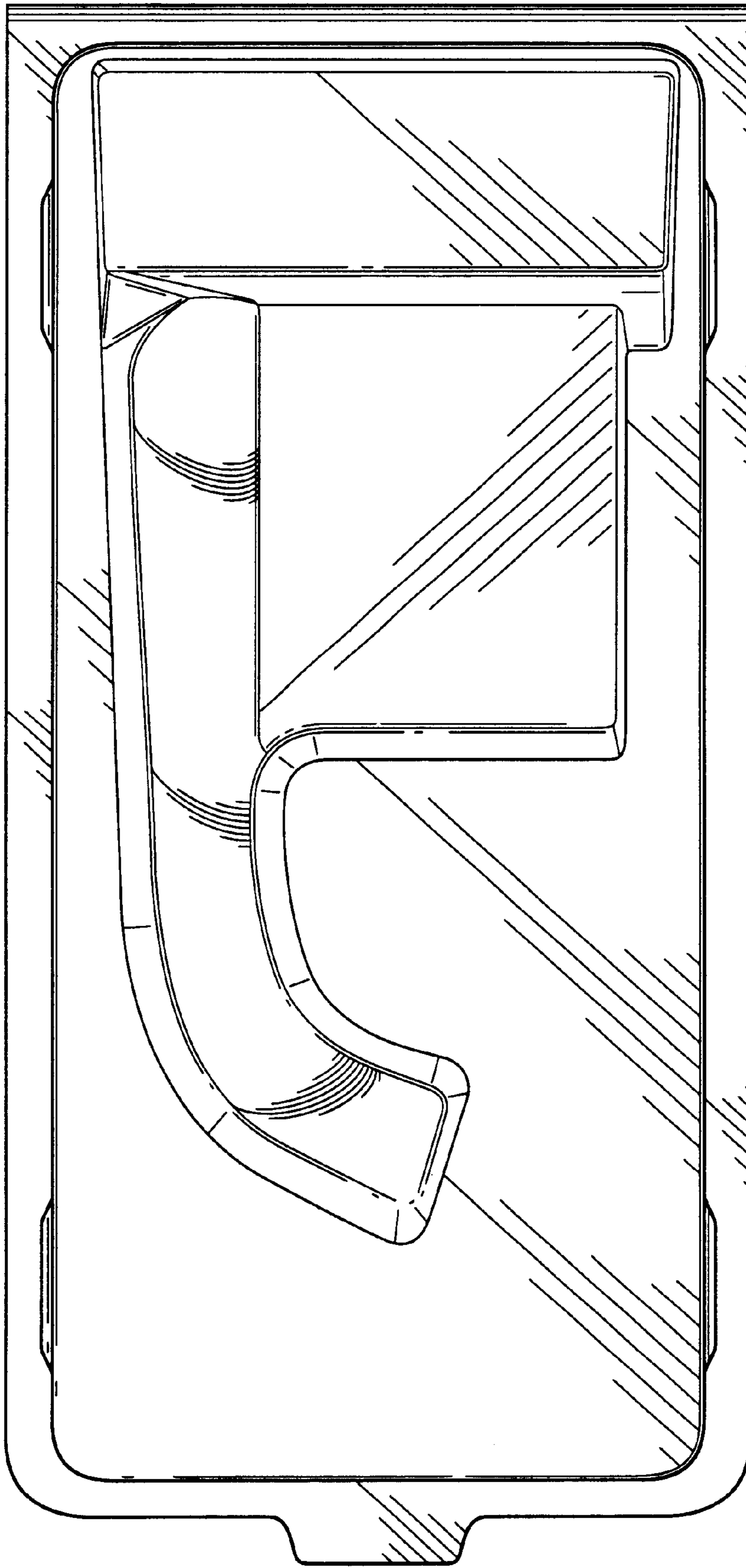

FIG. 7