



US00D453889S

(12) **United States Design Patent**  
**Caudill et al.**

(10) **Patent No.:** **US D453,889 S**

(45) **Date of Patent:** **\*\* Feb. 26, 2002**

(54) **HANDLE FOR A UTENSIL**

(76) Inventors: **Thomas H. Caudill; Benjamin A. Lacy**, both of 2194 Cat Creek Rd., Stanton, KY (US) 40380

(\*\*) Term: **14 Years**

(21) Appl. No.: **29/144,814**

(22) Filed: **Jul. 11, 2001**

(51) **LOC (7) Cl.** ..... **07-03**

(52) **U.S. Cl.** ..... **D7/401.2**

(58) **Field of Search** ..... D7/642, 645, 649, D7/650, 652, 653, 662-664, 401.2; D21/681, 682; 30/147-150, 322, 324, 329, 340, 345

(56) **References Cited**

**U.S. PATENT DOCUMENTS**

D83,198 S	*	2/1931	Herndon	.....	D28/48
D139,187 S		10/1944	Wagner		
D148,430 S		1/1948	Luhn		
3,918,158 A		11/1975	Debski		
D278,304 S	*	4/1985	Laslo	.....	D7/664
D304,539 S		11/1989	Johansson		
4,993,156 A		2/1991	Craven		
D329,966 S		10/1992	Neie		
D344,216 S		2/1994	Shepherd et al.		
D414,073 S	*	9/1999	Lai	.....	D7/401.2

\* cited by examiner

*Primary Examiner*—Caron D. Veynar

(74) *Attorney, Agent, or Firm*—Frost Brown Todd LLC; Robert H. Eichenberger

(57) **CLAIM**

The ornamental design for a handle for a utensil, as shown and described.

**DESCRIPTION**

FIG. 1 is a top view of a handle for a utensil, showing environmental structure comprising a spoon;  
 FIG. 2 is a front view thereof;  
 FIG. 3 is a left side view thereof;  
 FIG. 4 is a right side view thereof;  
 FIG. 5 is a bottom view thereof;  
 FIG. 6 is a top view of a handle for a utensil, showing environmental structure comprising a fork;  
 FIG. 7 is a front view thereof;  
 FIG. 8 is a left side view thereof;  
 FIG. 9 is a right side view thereof;  
 FIG. 10 is a bottom view thereof;  
 FIG. 11 is a top view of a handle for a utensil, showing environmental structure comprising a knife;  
 FIG. 12 is a front view thereof;  
 FIG. 13 is a left side view thereof;  
 FIG. 14 is a right side view thereof;  
 FIG. 15 is a rear view thereof; and,  
 FIG. 16 is a bottom view thereof.

The broken lines showing a spoon, fork, and knife in FIGS. 1-16 are for illustrative purposes only and form no part of the claimed design.

FIGS. 11-16 are drawn on a reduced scale from FIGS. 1-10.

**1 Claim, 6 Drawing Sheets**

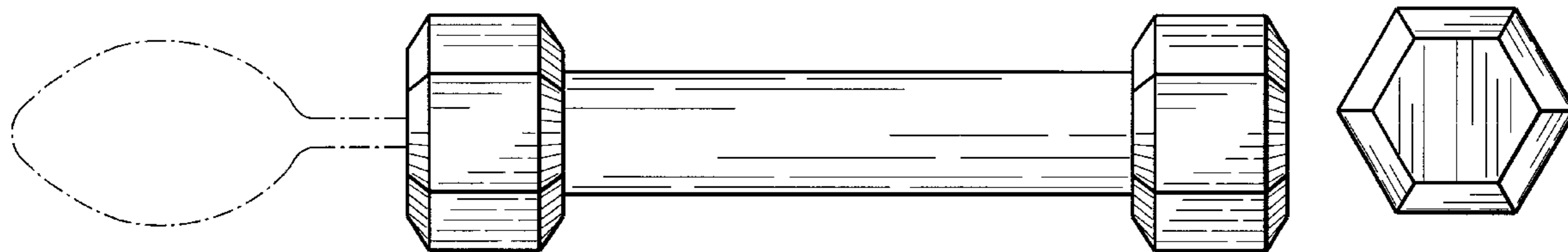

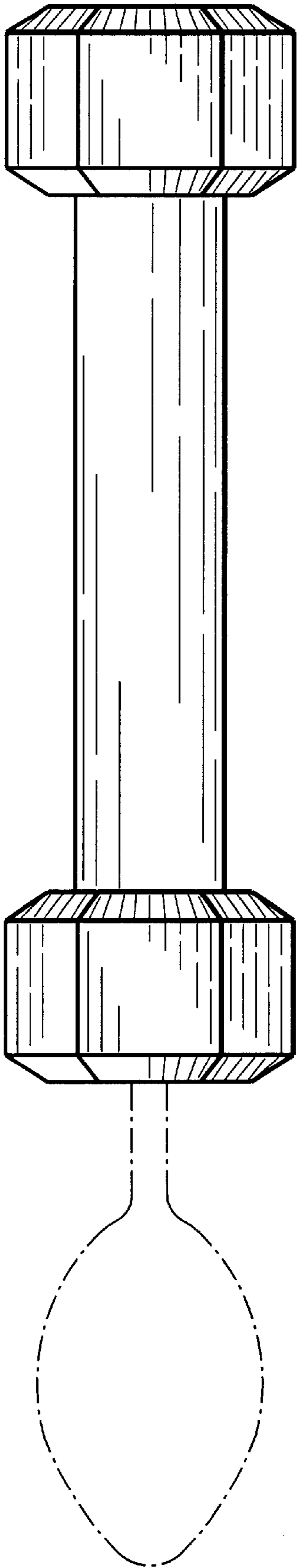

*Fig. 1*

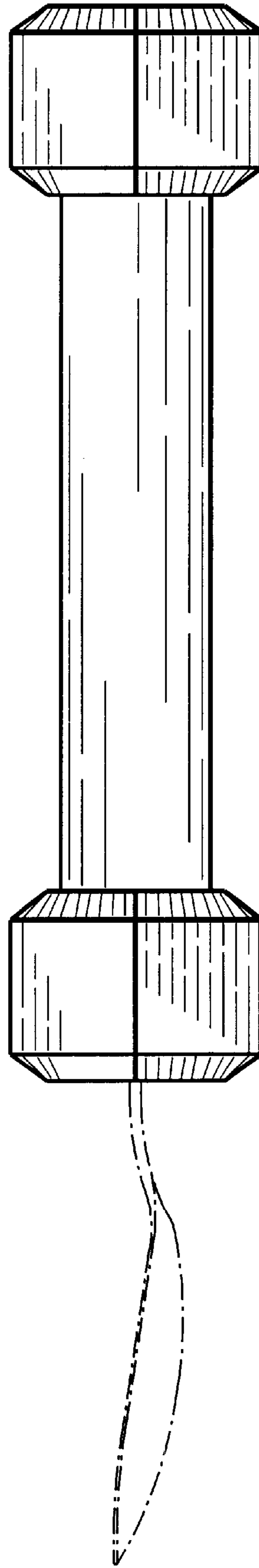

*Fig. 2*

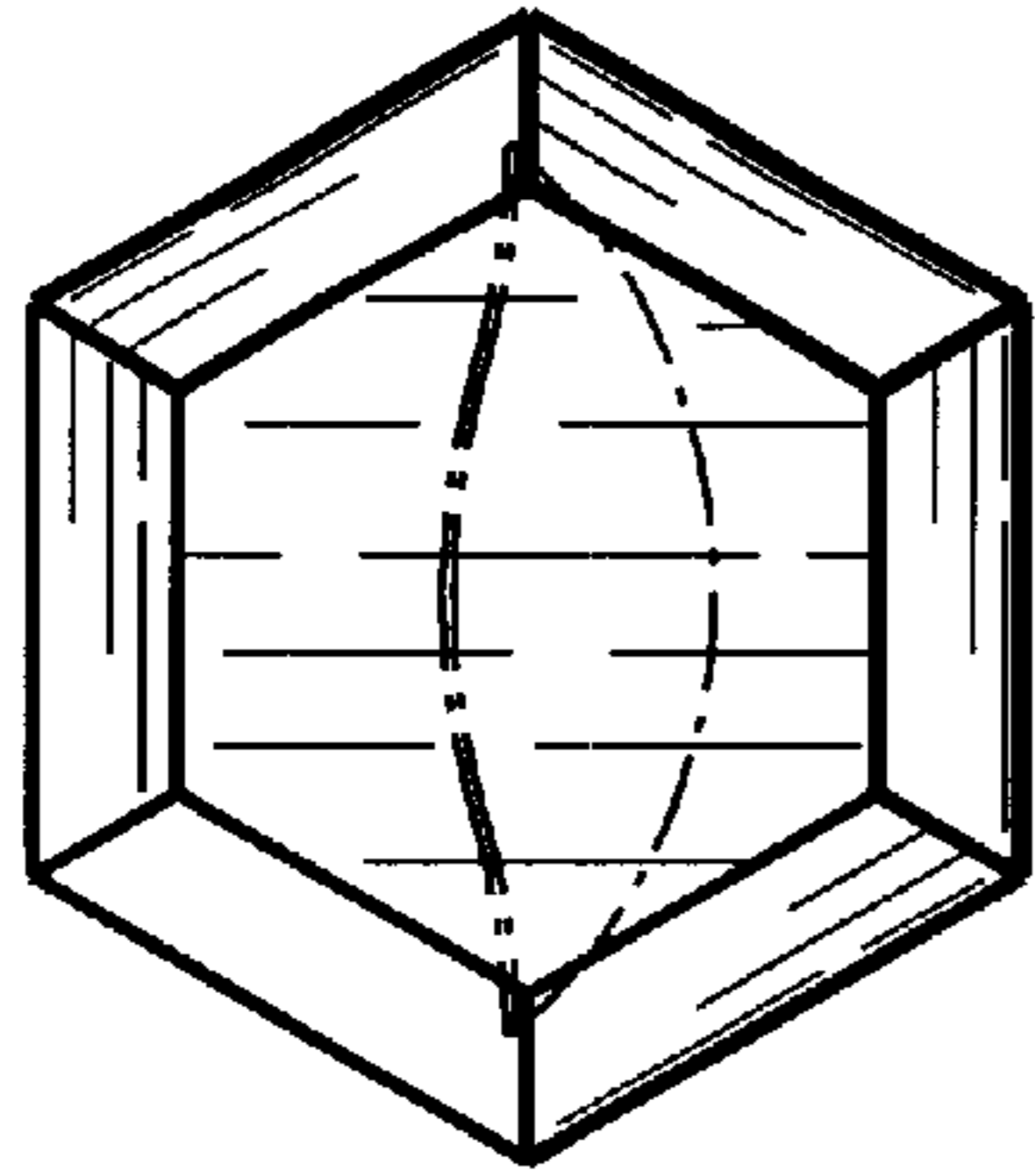

Fig. 3

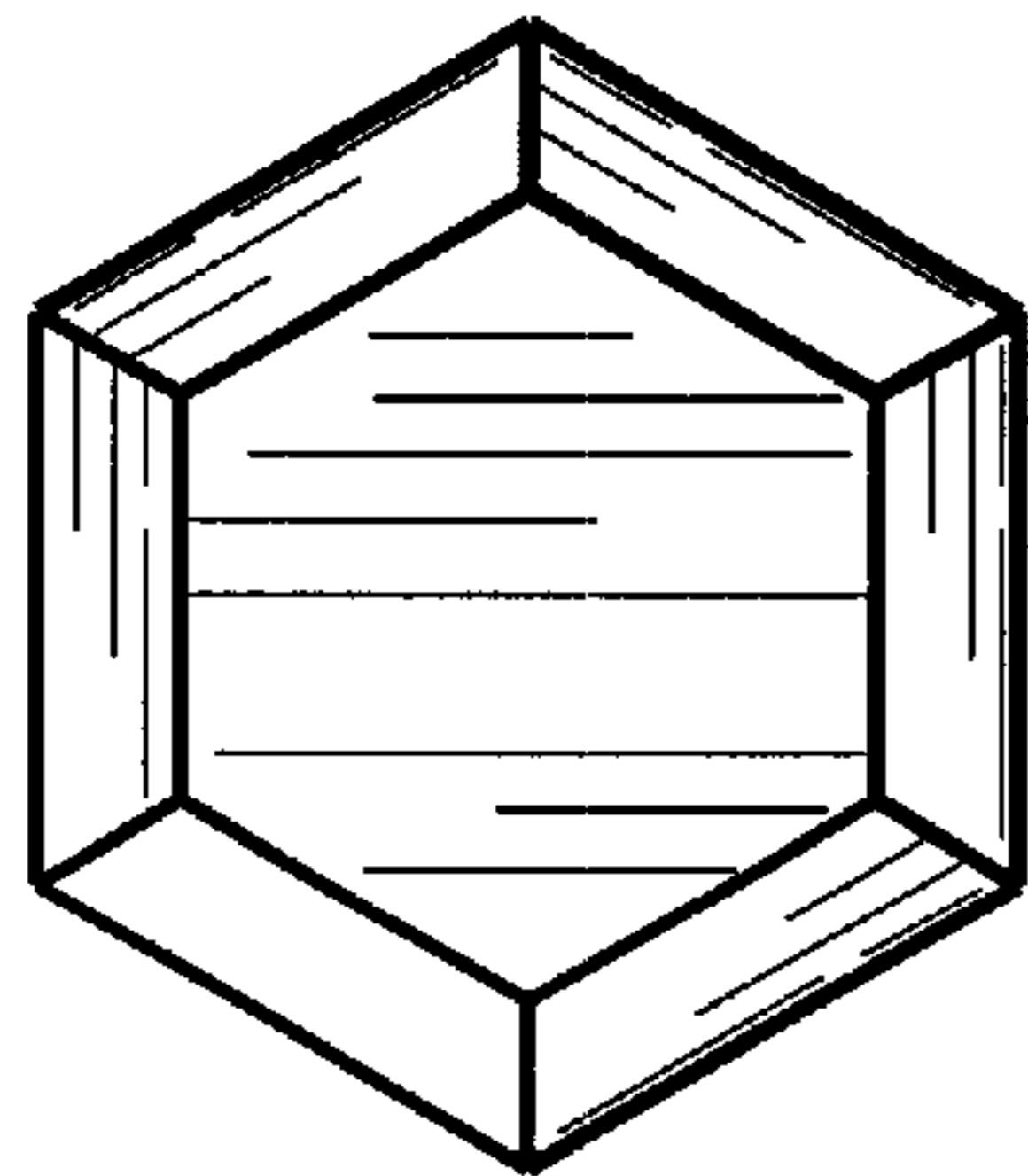

Fig. 4

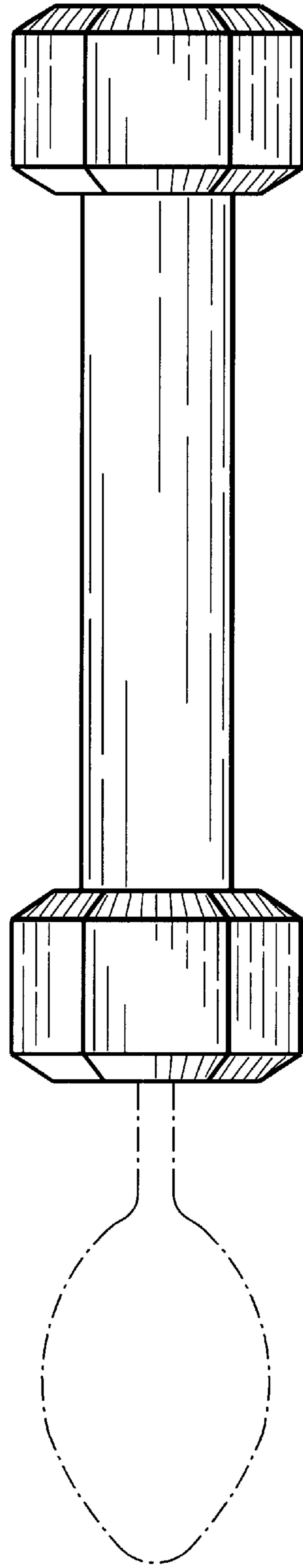
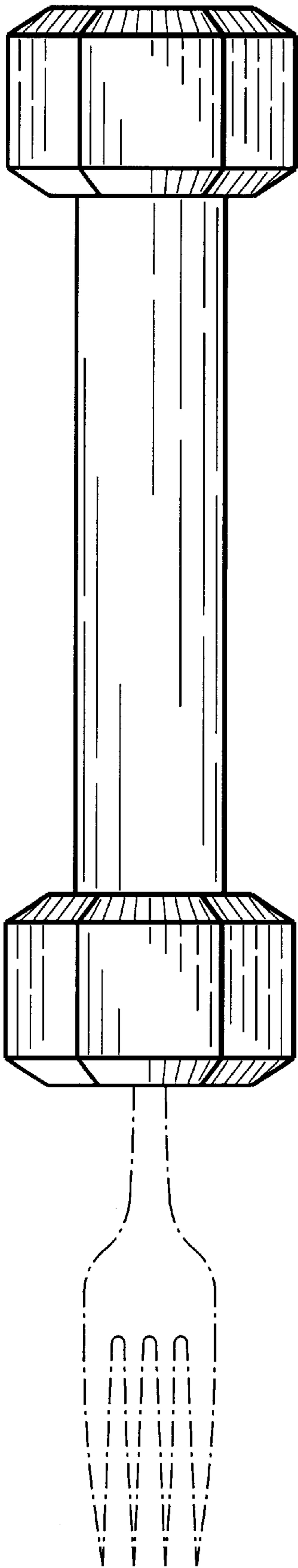
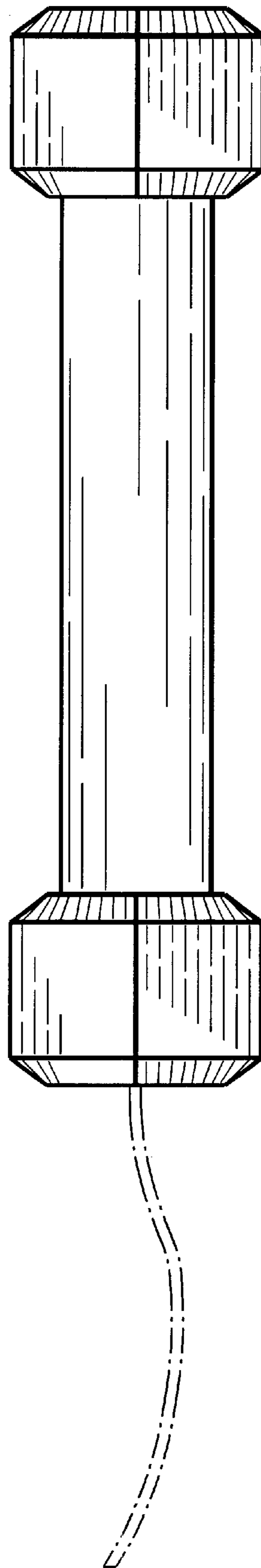

Fig. 5



*Fig. 6*



*Fig. 7*

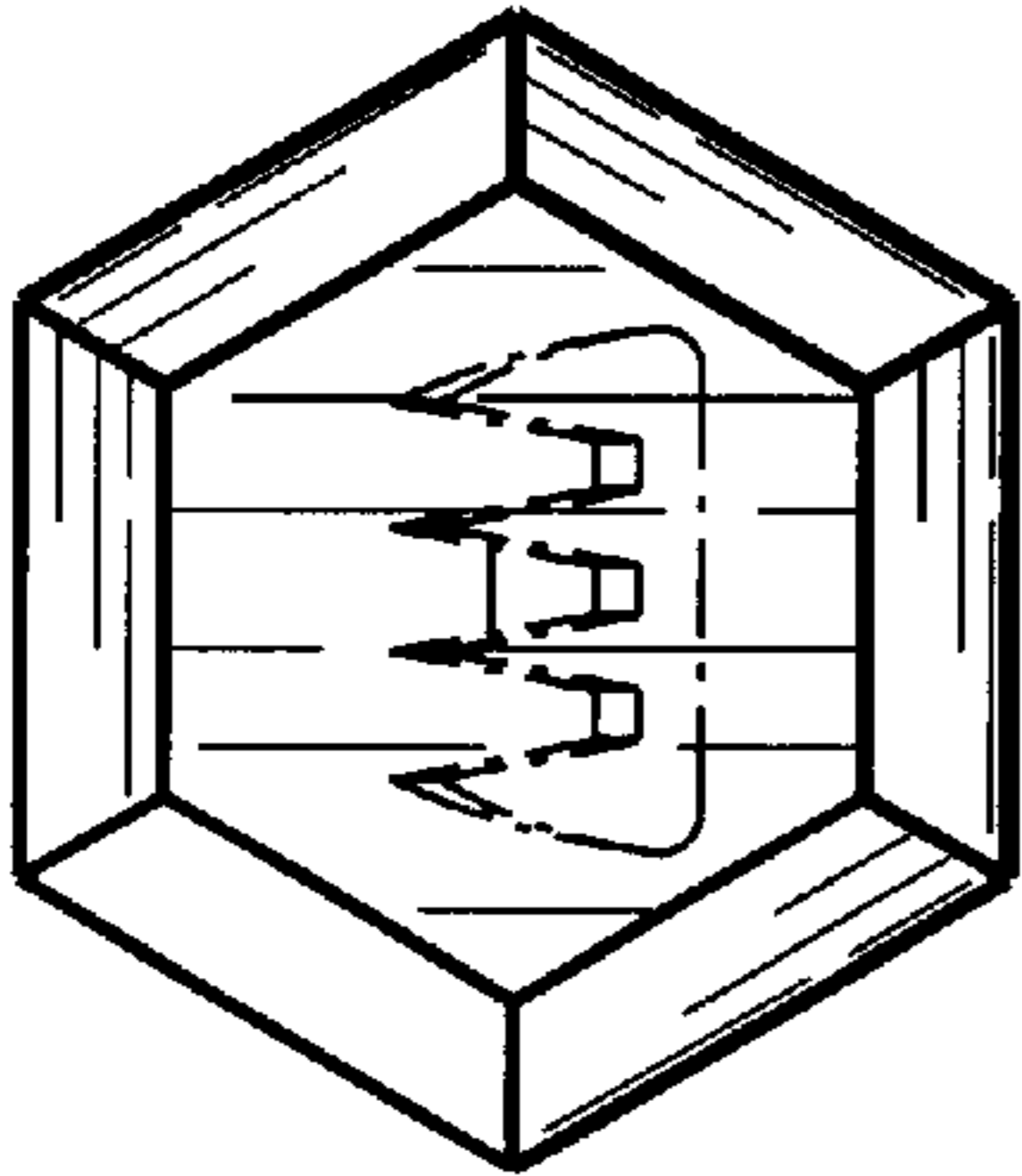

Fig. 8

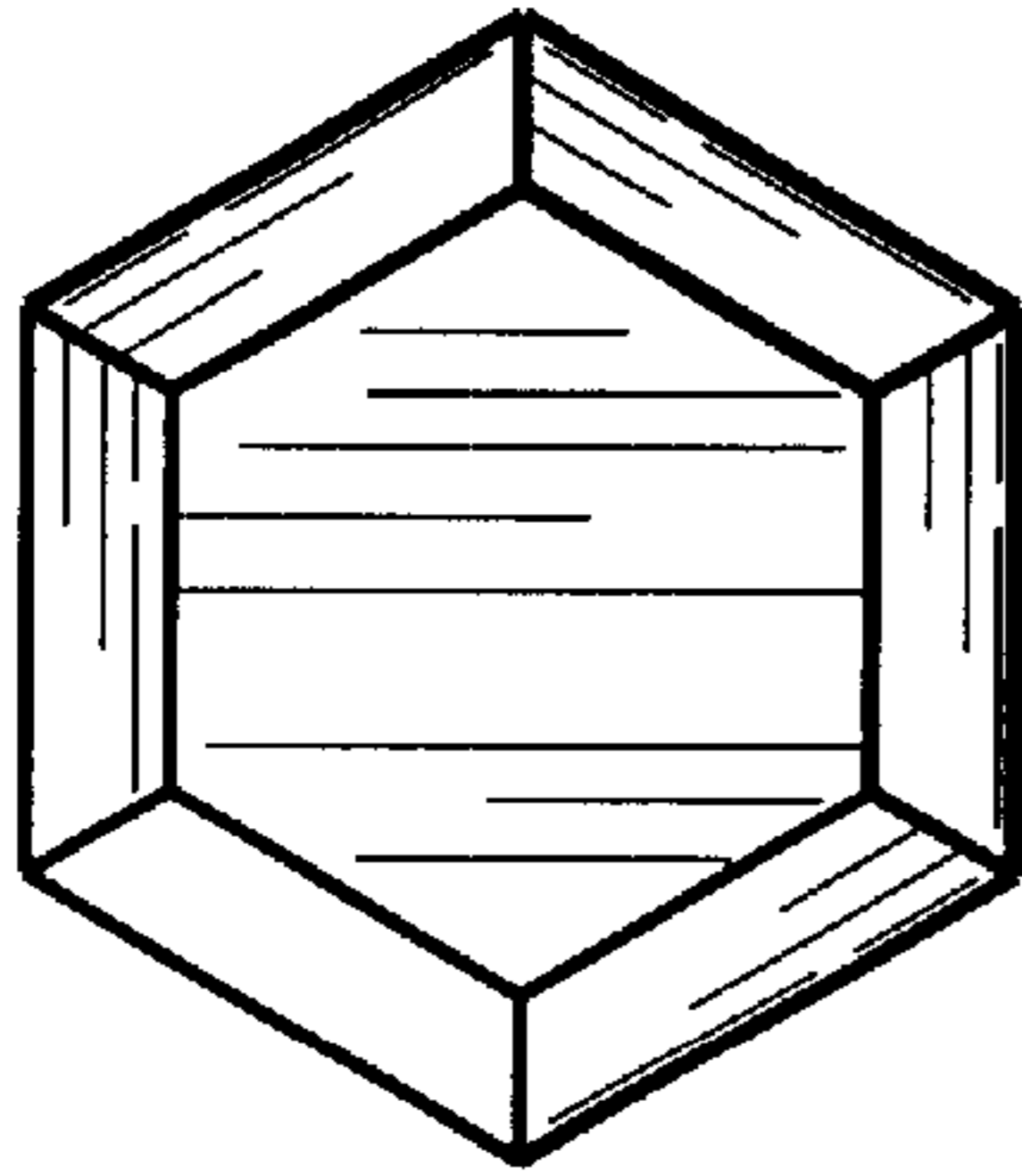

Fig. 9

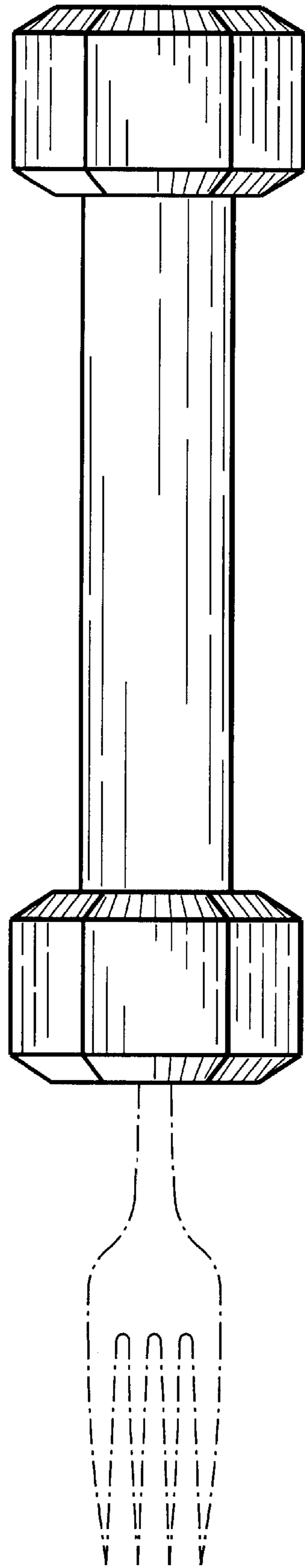
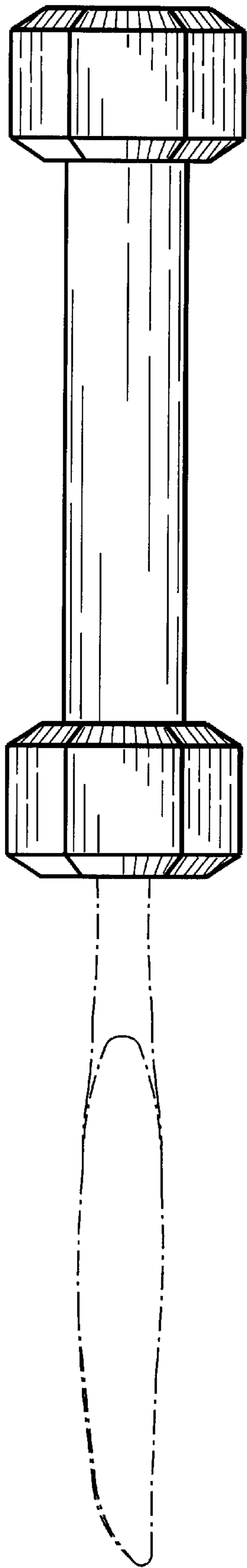
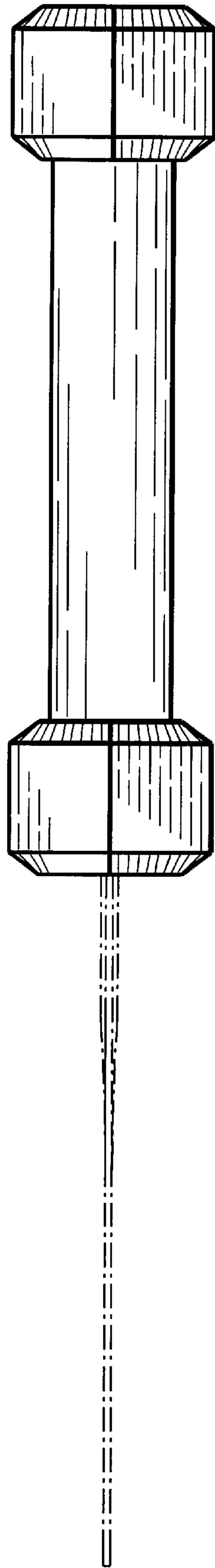

Fig. 10



*Fig. 11*



*Fig. 12*

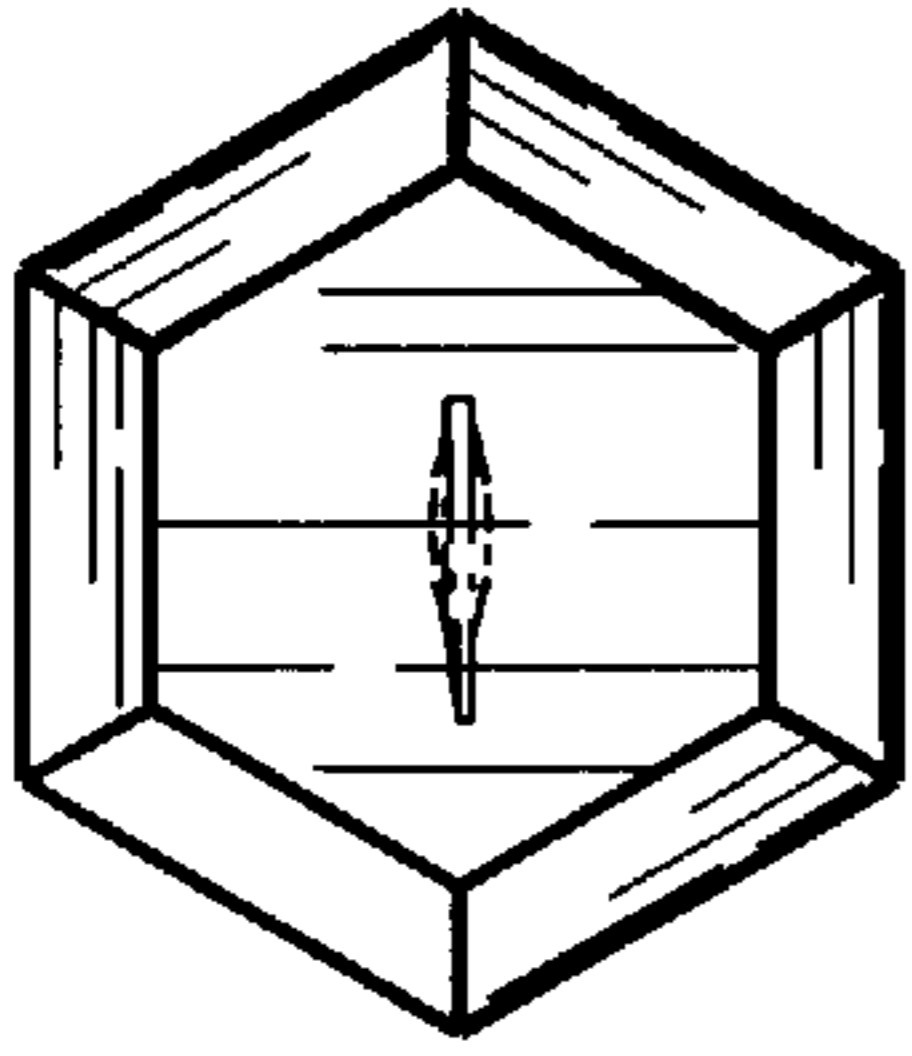

Fig. 13

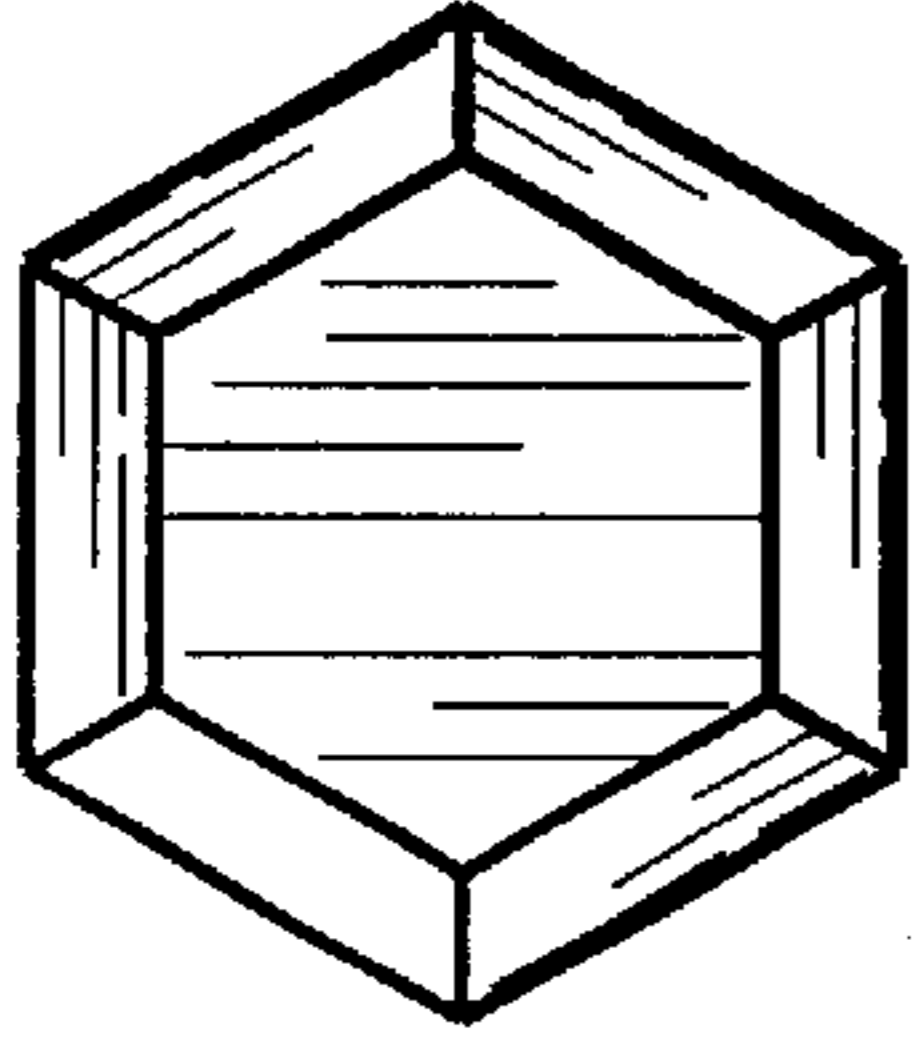

Fig. 14

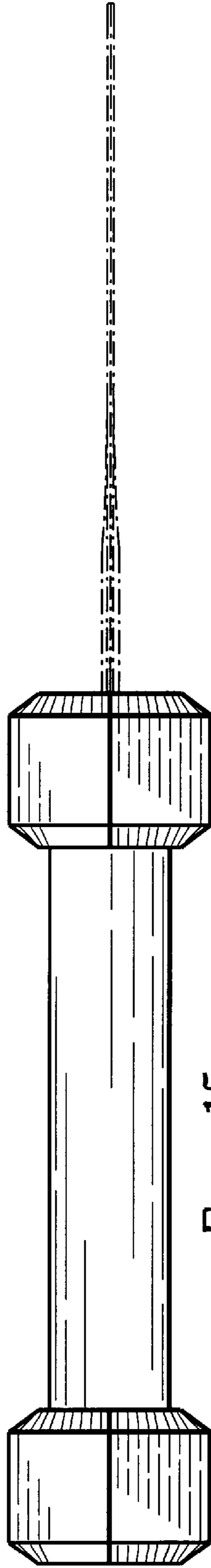

Fig. 15

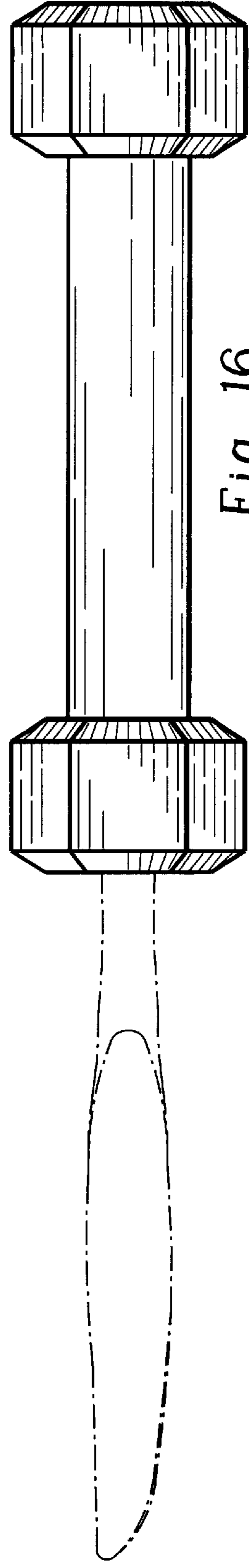

Fig. 16