



US00D453864S

(12) **United States Design Patent**
Olivares et al.

(10) **Patent No.:** **US D453,864 S**

(45) **Date of Patent:** **** Feb. 19, 2002**

(54) **SPIRALLY ROLLED PET PRODUCT**

D385,686 S * 11/1997 Parker D1/122
D391,735 S * 3/1998 Baker D1/106
6,014,950 A * 1/2000 Rogers 119/710

(76) Inventors: **José Tirso Olivares**, 525 N. Ada,
Chicago, IL (US) 60622; **Joseph M.
Kornick**, 612 W. Belden, Chicago, IL
(US) 60614

* cited by examiner

(**) Term: **14 Years**

Primary Examiner—Cathy Anne MacCormac
(74) *Attorney, Agent, or Firm*—Lee, Mann, Smith,
McWilliams, Sweeney & Ohlson

(21) Appl. No.: **29/138,444**

(57) **CLAIM**

(22) Filed: **Mar. 13, 2001**

The ornamental design for a spirally rolled pet product, as shown and described.

(51) **LOC (7) Cl.** **30-99**

(52) **U.S. Cl.** **D30/160; D1/199**

(58) **Field of Search** D30/160; D1/100,
D1/106, 118, 120, 122, 125-128, 130, 199;
119/707-711; 426/104

DESCRIPTION

(56) **References Cited**

U.S. PATENT DOCUMENTS

2,051,682 A * 5/1936 Couture D1/122
D197,595 S * 3/1964 Savitt D30/160
5,390,629 A * 2/1995 Simone 119/711

FIG. 1 is a bottom plan view of the invention;
FIG. 2 is a right side elevational view of the invention;
FIG. 3 is a perspective view of the invention;
FIG. 4 is a rear elevational view of the invention;
FIG. 5 is a left side elevational view of the invention;
FIG. 6 is a top plan view of the invention; and,
FIG. 7 is a front elevational view of the invention.

1 Claim, 2 Drawing Sheets

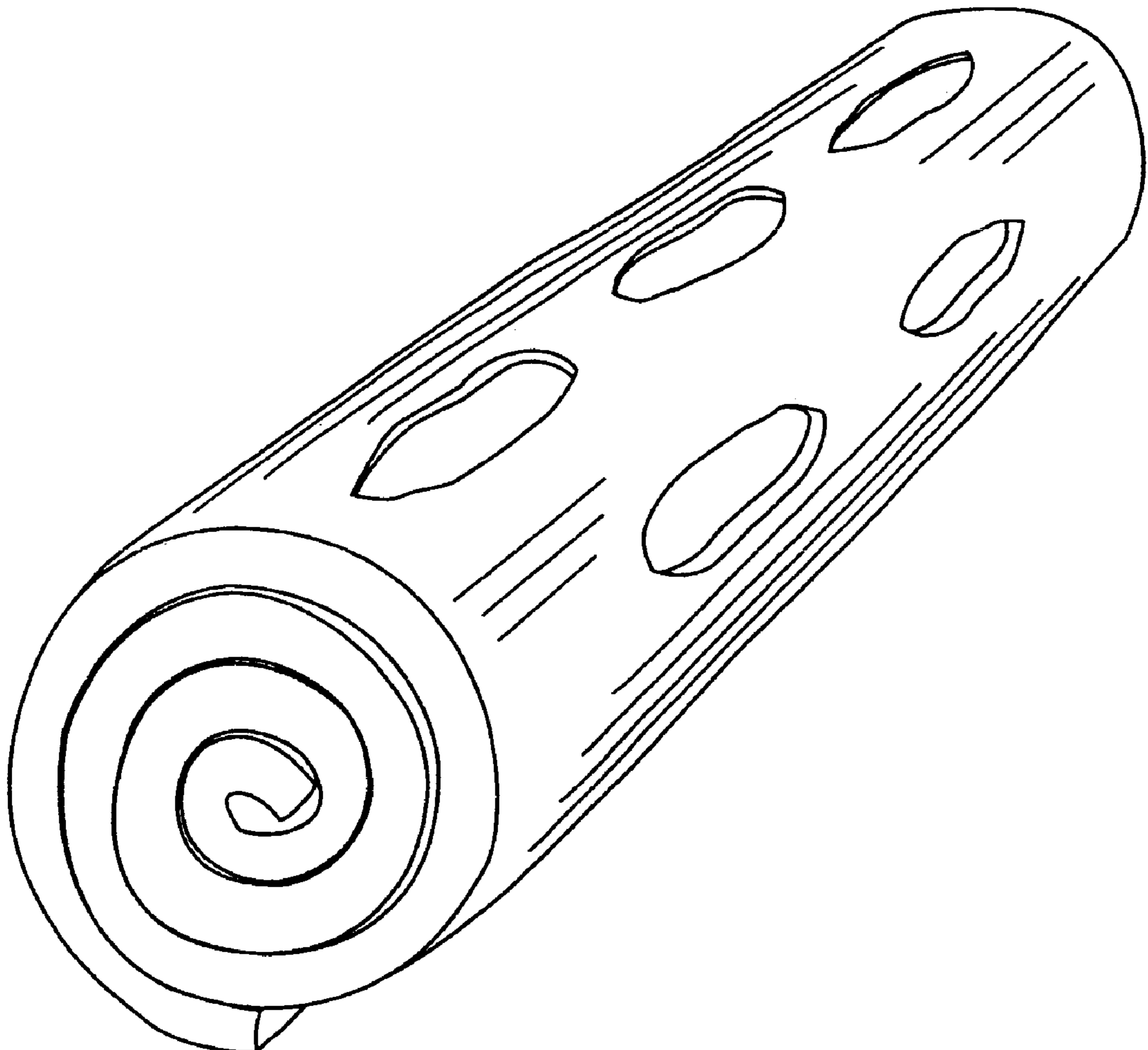

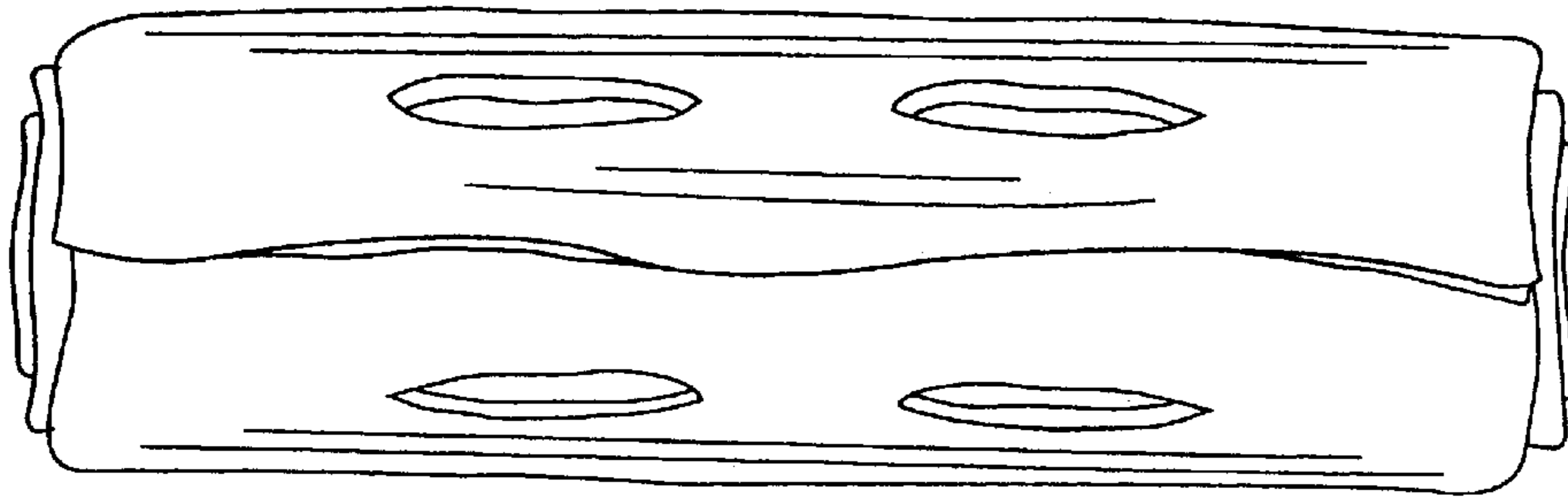

FIG. 1

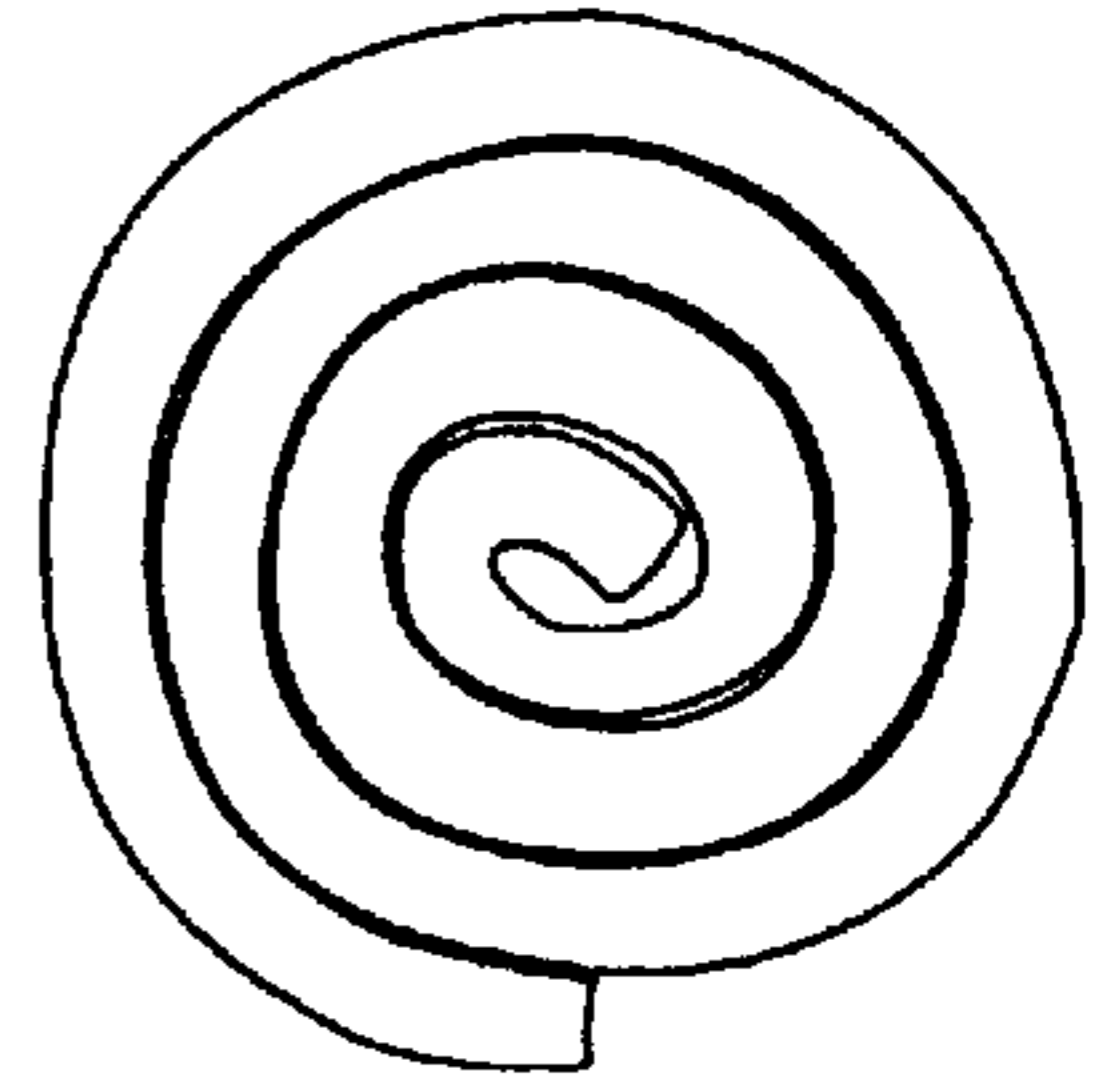

FIG. 2

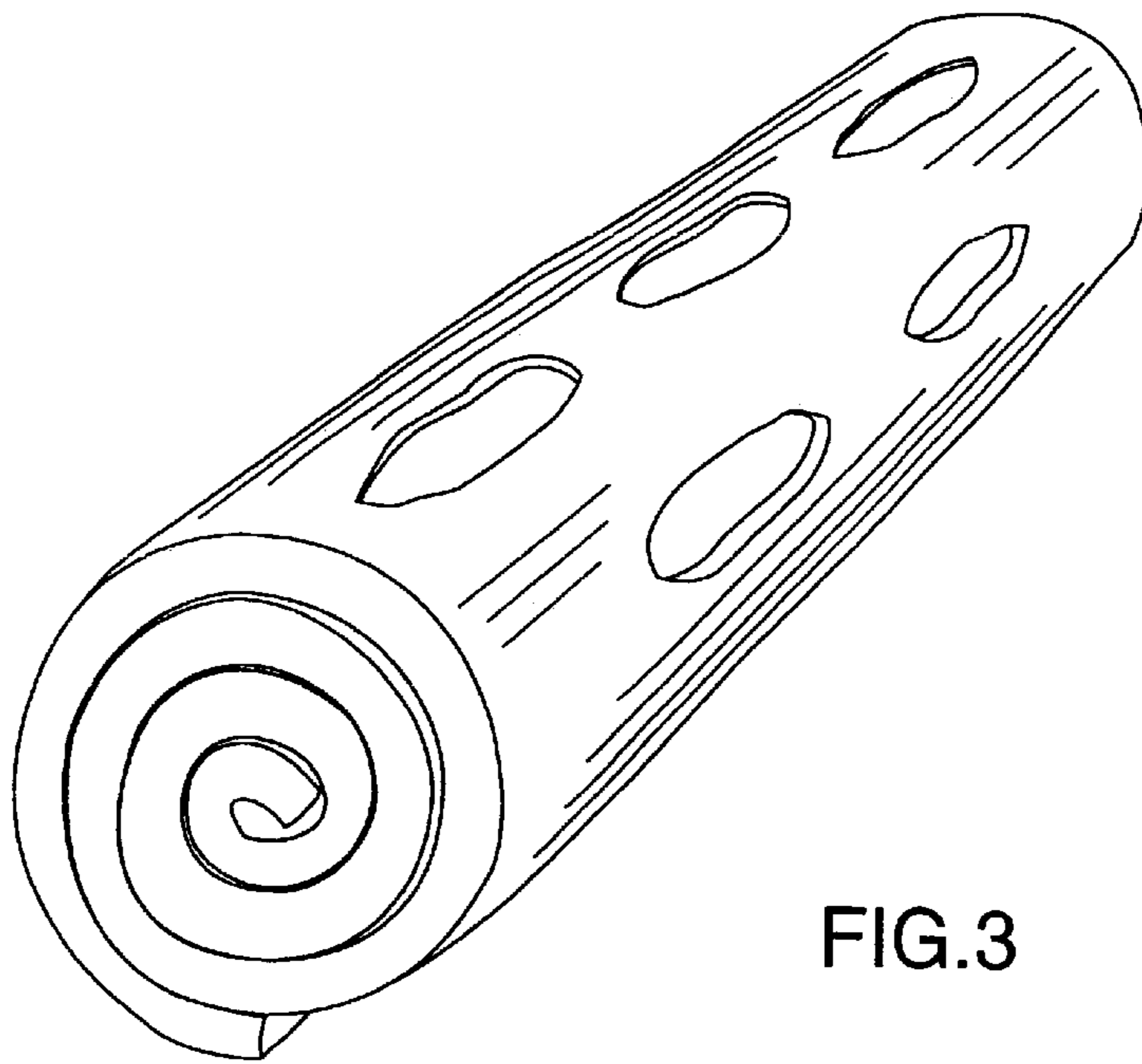

FIG. 3

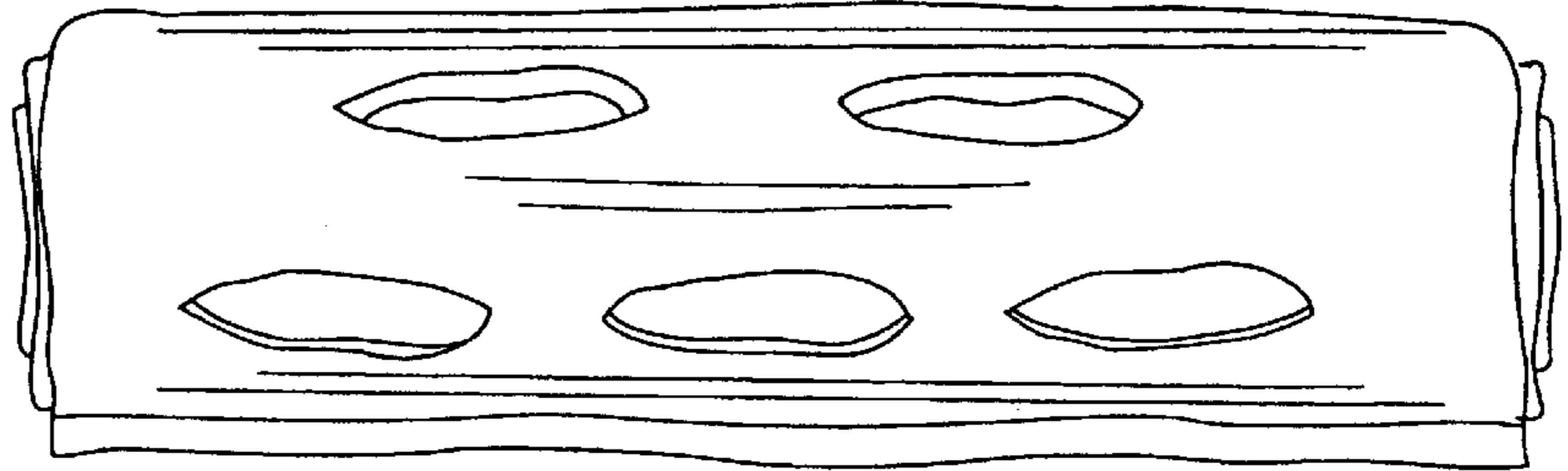

FIG. 4

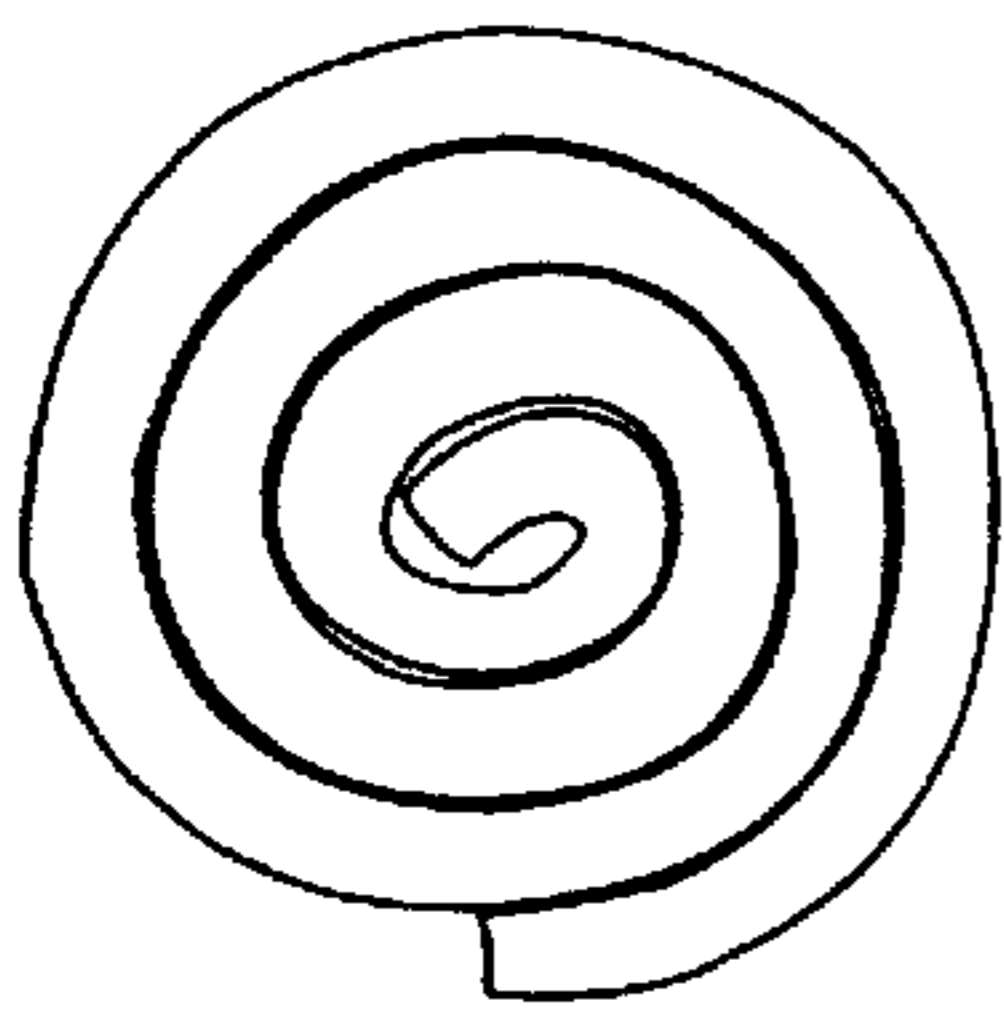

FIG. 5

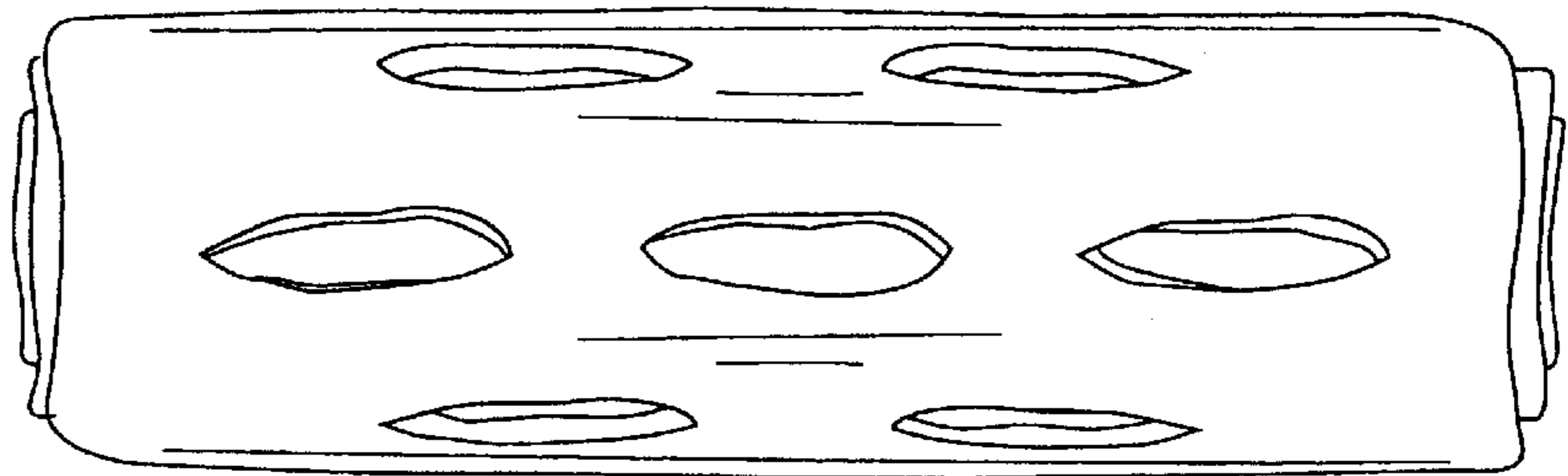

FIG. 6

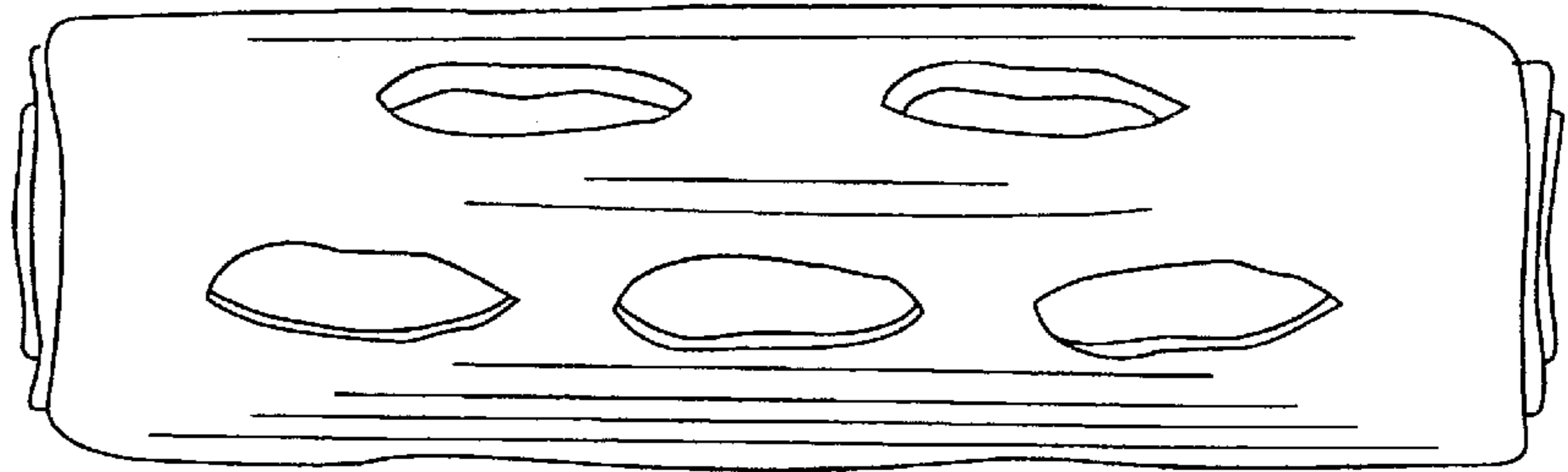

FIG. 7