



US00D453803S

(12) **United States Design Patent**
Yann et al.

(10) **Patent No.:** **US D453,803 S**

(45) **Date of Patent:** **** Feb. 19, 2002**

(54) **SKATEBOARD DEVICE**

(76) Inventors: **Yang-Tzyy Yann; Te-Wang Liao**, both
of 58, Ma Yuan West St., Taichung
(TW)

(**) Term: **14 Years**

(21) Appl. No.: **29/135,003**

(22) Filed: **Dec. 29, 2000**

(51) **LOC (7) Cl.** **21-01**

(52) **U.S. Cl.** **D21/423**

(58) **Field of Search** D21/419, 421,
D21/423, 424, 426, 435, 533, 760, 765,
771; D12/107, 110-112; 280/87.01, 87.021,
87.041, 87.042; 180/181, 216

(56) **References Cited**

U.S. PATENT DOCUMENTS

D178,619 S * 8/1956 Tonelli D21/423
4,394,029 A * 7/1983 Holmgren 280/87.041

D289,065 S * 3/1987 Schultz D21/423
4,775,162 A * 10/1988 Chao 280/87.041
6,155,553 A * 3/2000 Wang 280/87.041
D435,874 S * 1/2001 Cheng D21/423

* cited by examiner

Primary Examiner—Raphael Barkai

(57) **CLAIM**

The ornamental design for a skateboard device, as shown
and described.

DESCRIPTION

FIG. 1 is a perspective view of a skateboard device showing
my new design;

FIG. 2 is a front elevational view thereof;

FIG. 3 is a rear elevational view thereof;

FIG. 4 is a left side elevational view thereof.

FIG. 5 is a right side elevational view thereof;

FIG. 6 is a top plan view thereof; and,

FIG. 7 is a bottom plan view thereof.

1 Claim, 7 Drawing Sheets

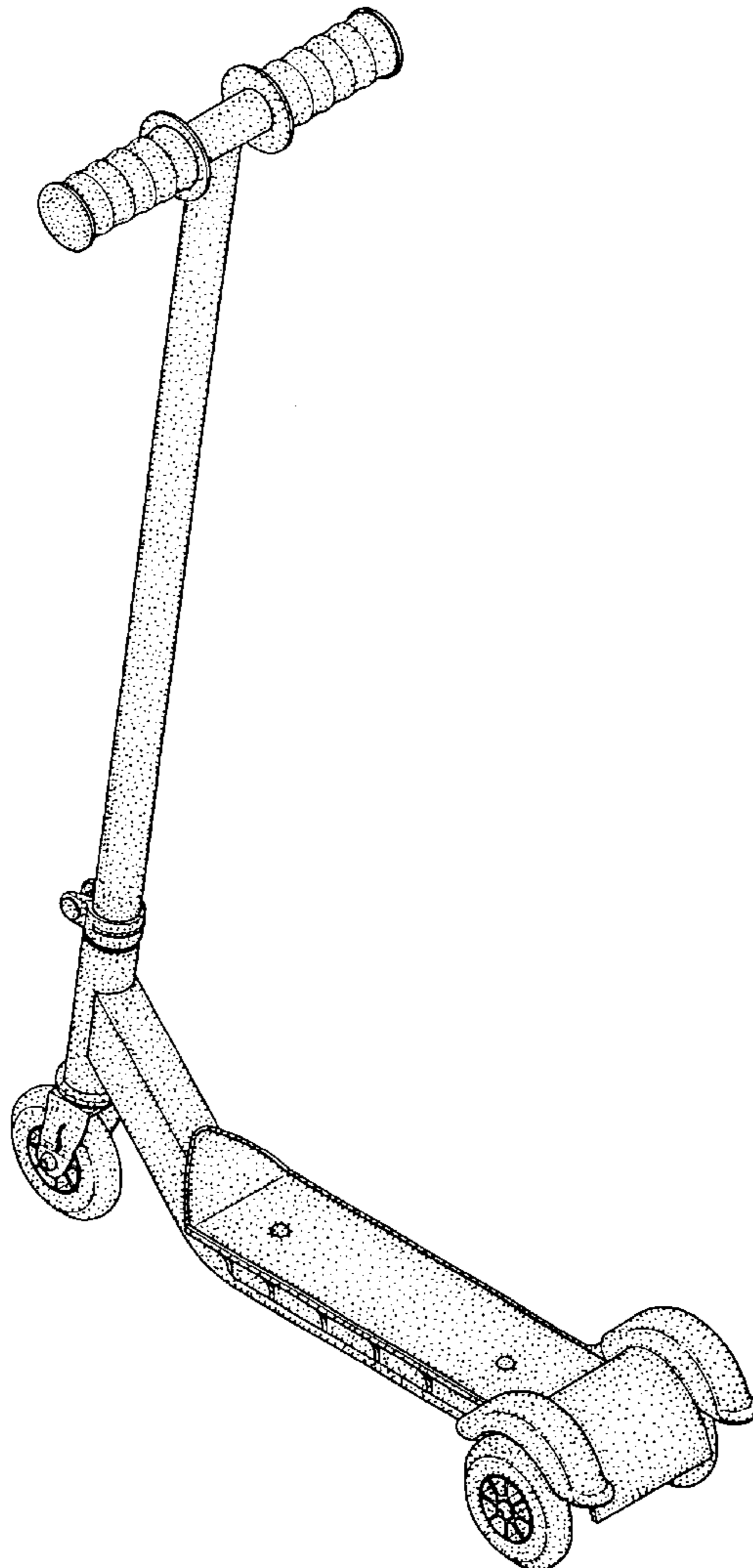

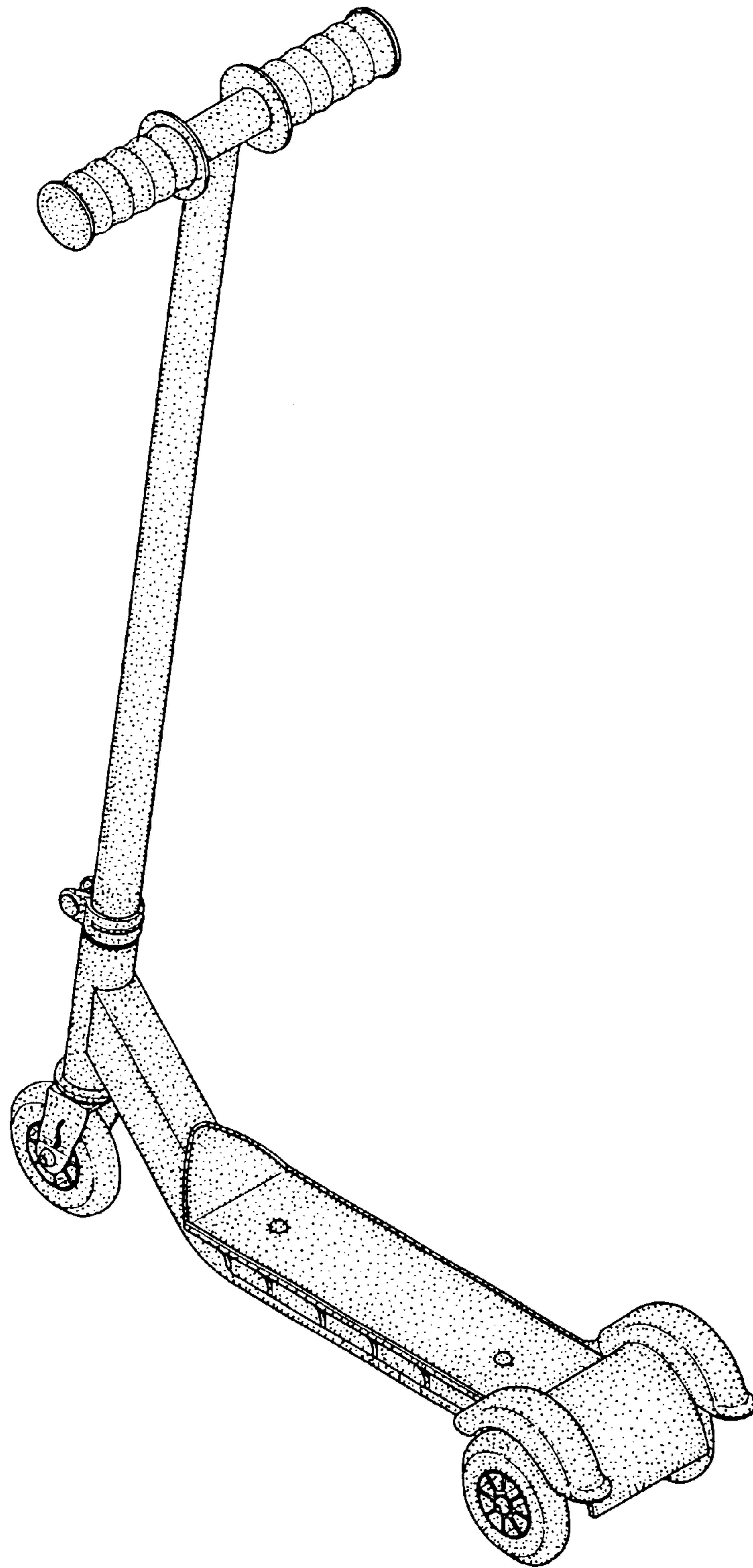

FIG. 1

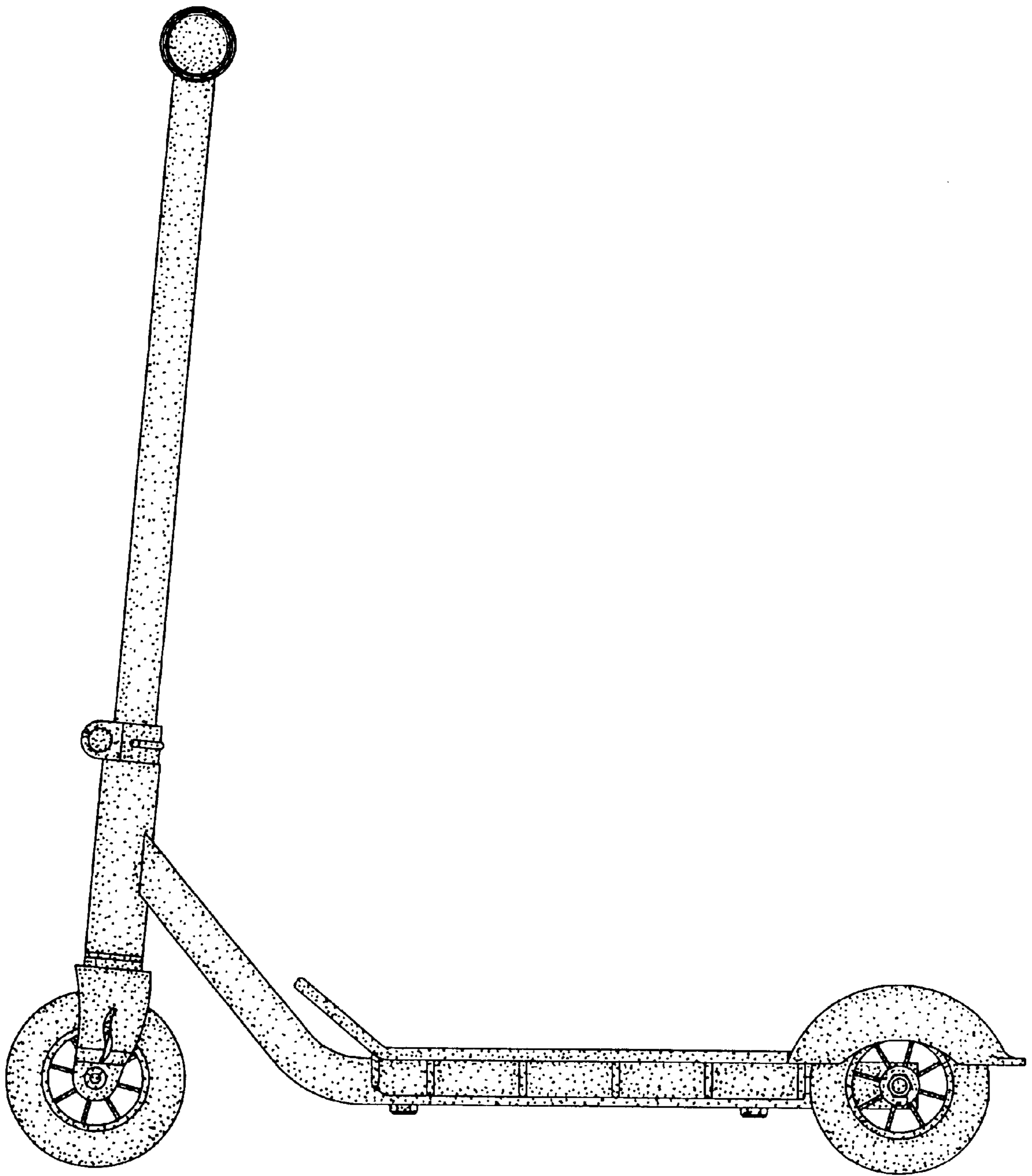

FIG. 2

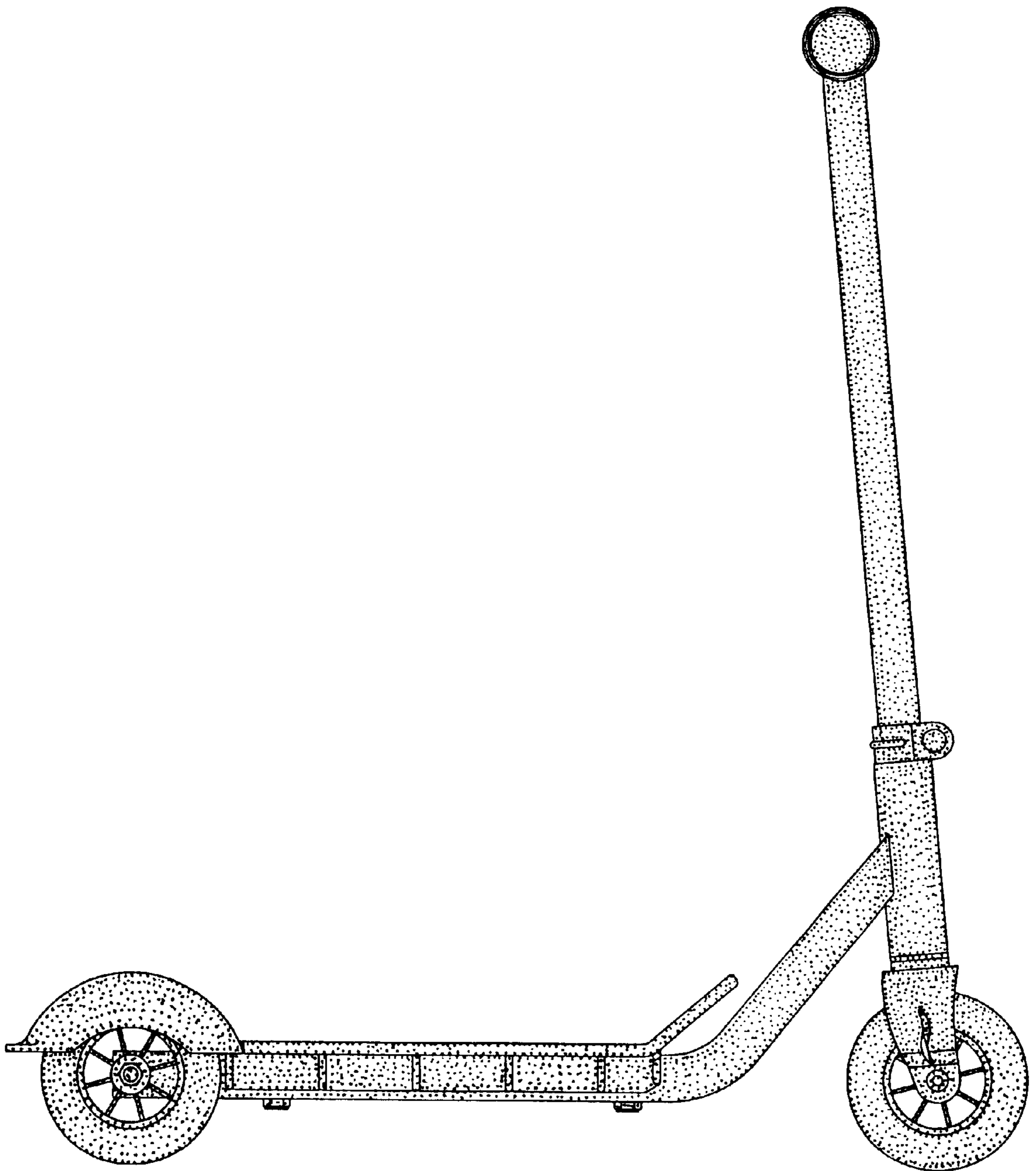

FIG. 3

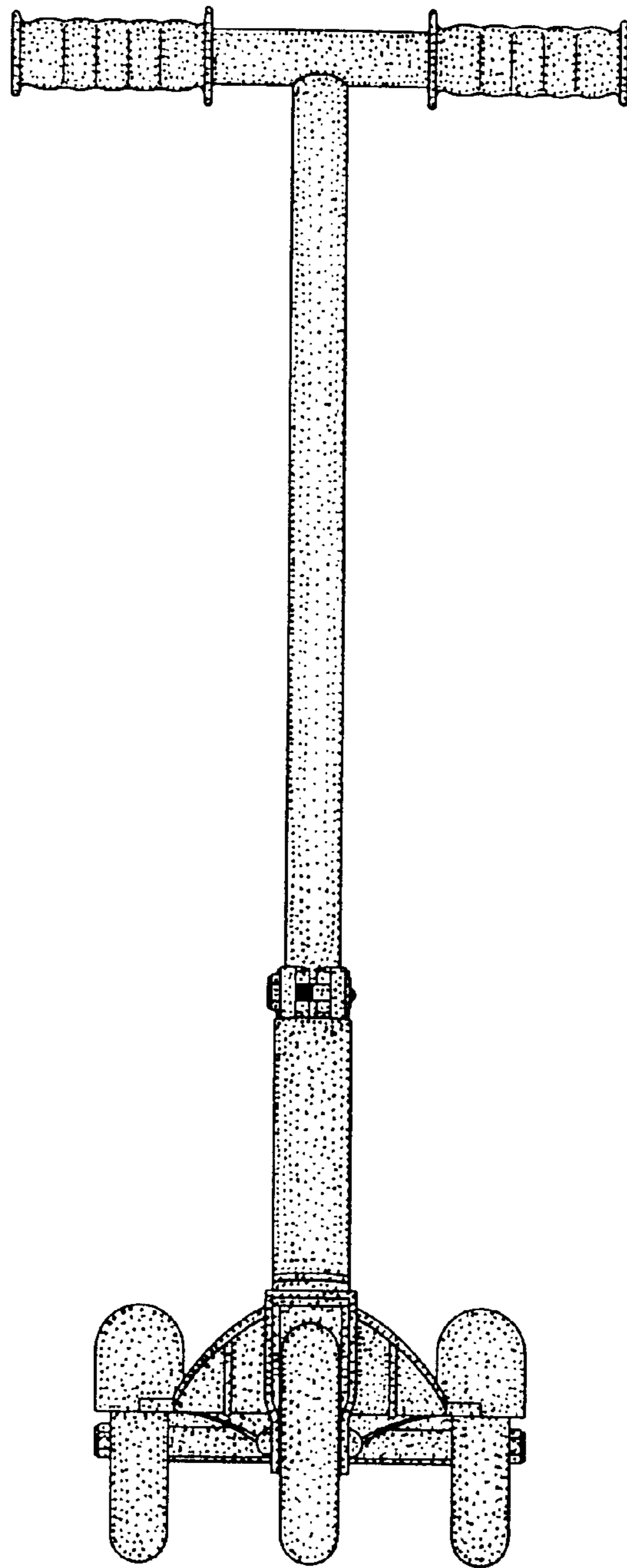

FIG. 4

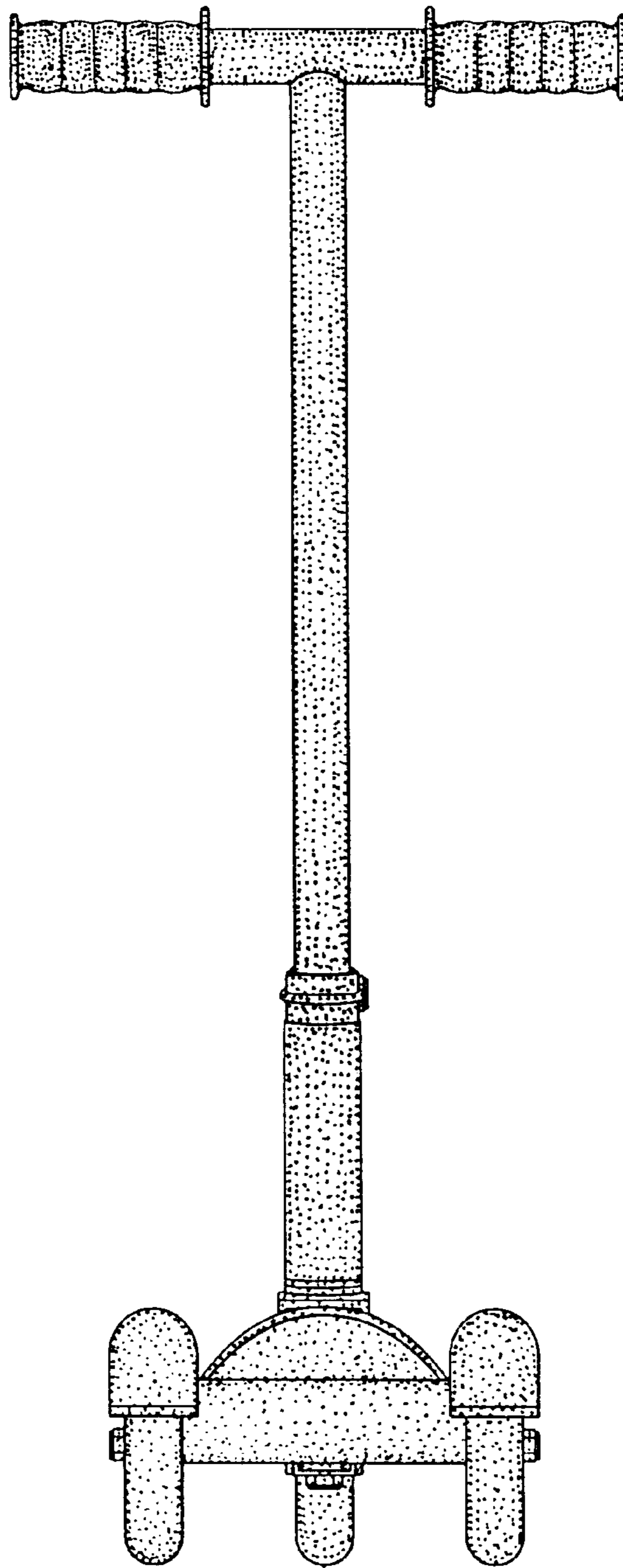
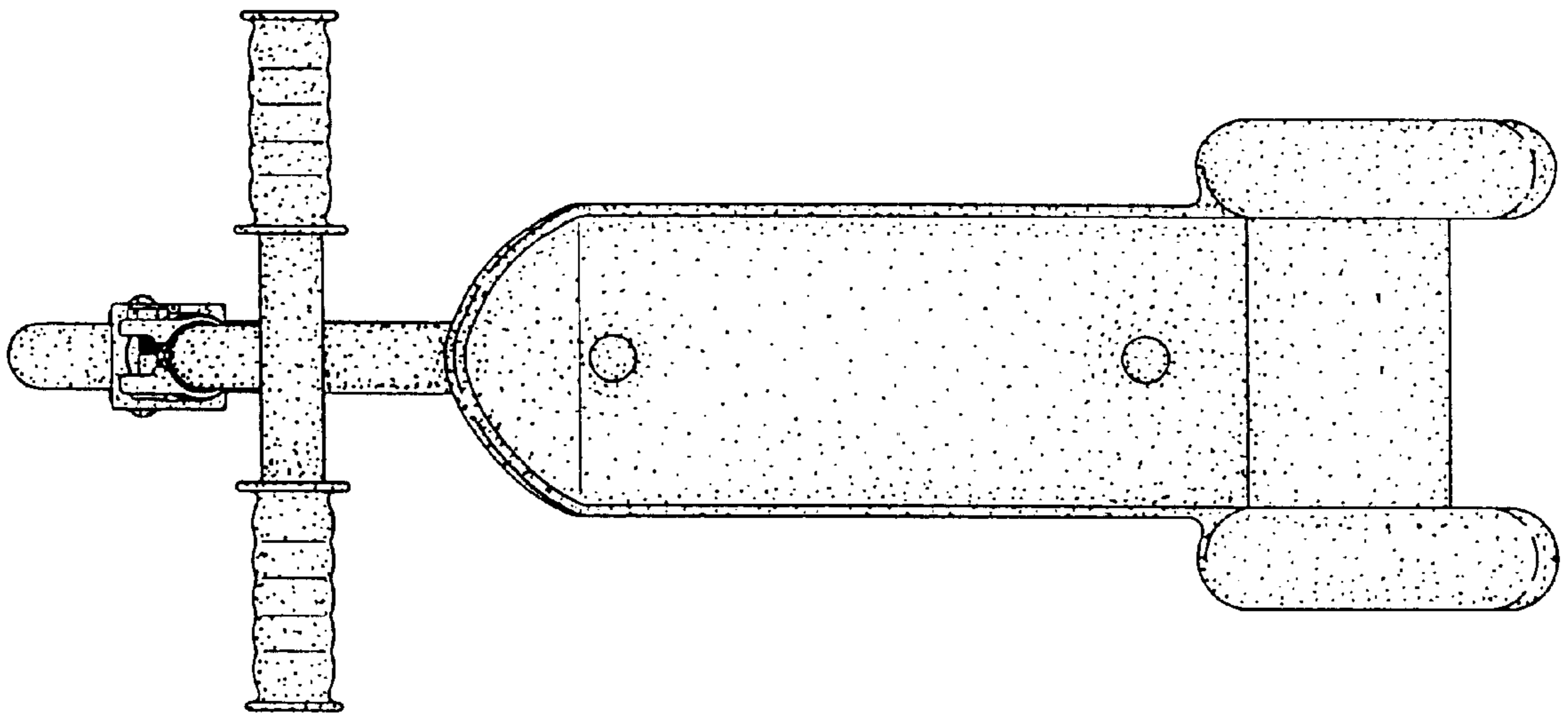

FIG. 5



F I G. 6

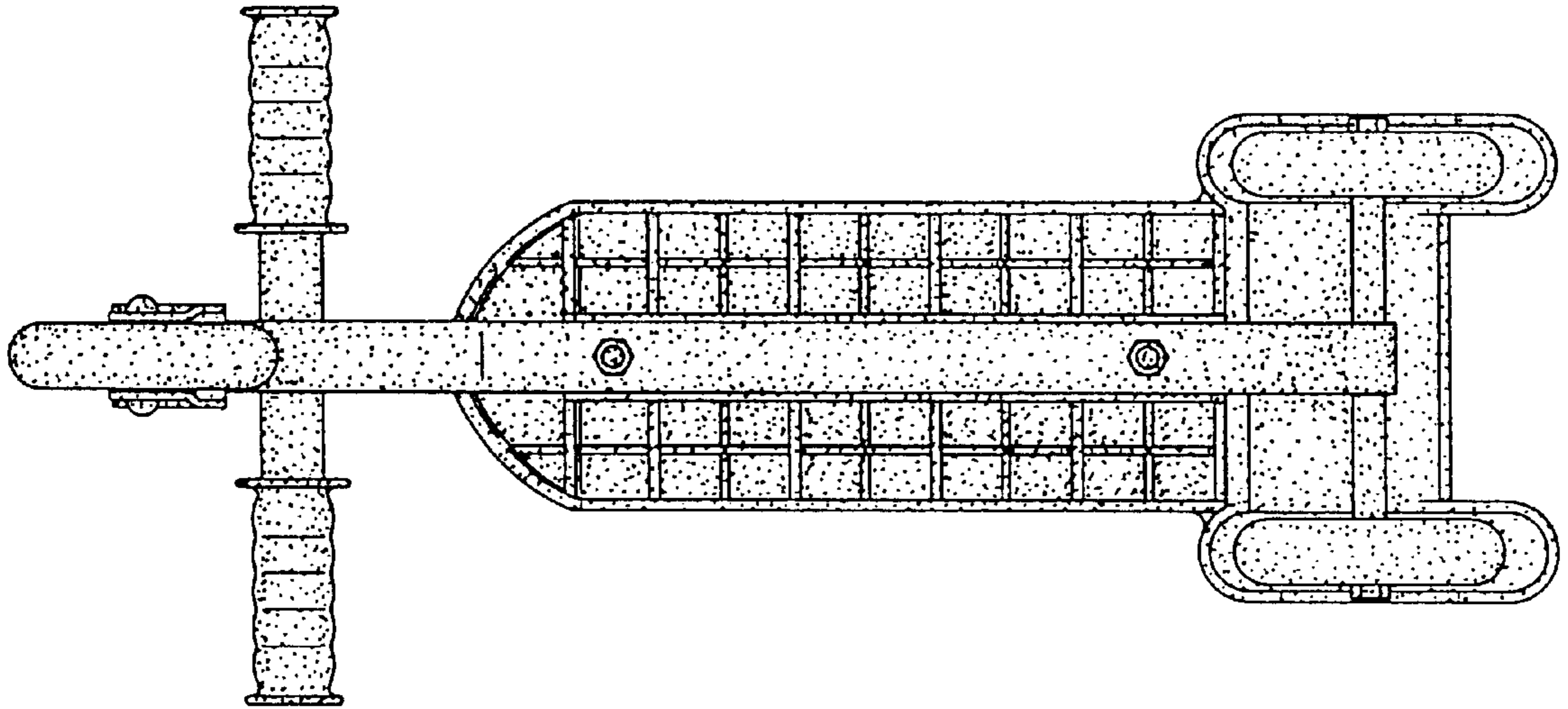

FIG. 7