



US00D453706S

(12) **United States Design Patent**
Lai

(10) **Patent No.:** **US D453,706 S**

(45) **Date of Patent:** **** *Feb. 19, 2002**

(54) **JEWELRY SETTING**

D432,448 S 10/2000 Lai

(75) Inventor: **Danny S. Lai**, New York, NY (US)

* cited by examiner

(73) Assignee: **Gramercy Jewelry Manufacturing Corp.**, New York, NY (US)

Primary Examiner—Ralf Seifert

(74) *Attorney, Agent, or Firm*—Baker Botts L.L.P.

(*) Notice: This patent is subject to a terminal disclaimer.

(57) **CLAIM**

The ornamental design of a jewelry setting, as shown and described.

(**) Term: **14 Years**

DESCRIPTION

(21) Appl. No.: **29/131,713**

FIG. 1 is a top view of a first embodiment of a jewelry setting according to the present invention provided in an earring;

(22) Filed: **Oct. 26, 2000**

FIG. 2 is a side view of the jewelry setting of FIG. 1;

(51) **LOC (7) Cl.** **11-01**

FIG. 3 is a perspective view of the jewelry setting of FIG. 1;

(52) **U.S. Cl.** **D11/91**

FIG. 4 is a side view of a second embodiment of the jewelry setting according to the present invention;

(58) **Field of Search** D11/76, 34, 40,
D11/89-91; 63/32, 26, 15

FIG. 5 is a top view of the jewelry setting of FIG. 4;

(56) **References Cited**

U.S. PATENT DOCUMENTS

2,907,187 A	10/1959	Karp et al.	
4,813,246 A	* 3/1989	Richards	63/26
5,123,265 A	6/1992	Ramot	
5,377,506 A	1/1995	Tranzer	
5,520,017 A	5/1996	Vivat	
D391,516 S	3/1998	Kothari	
D398,875 S	9/1998	Kothari	
5,848,539 A	12/1998	Ouzounian	
D403,611 S	1/1999	Lai	
D411,134 S	6/1999	Lai	
6,003,335 A	12/1999	Gurevich et al.	
6,026,660 A	2/2000	Lai	
D425,817 S	5/2000	Gurevich et al.	
D427,934 S	6/2000	Lai	

FIG. 6 is a perspective view of the jewelry setting of FIG. 4;

FIG. 7 is a perspective view of the jewelry setting of FIG. 4 provided on a chain;

FIG. 8 is a top view of a third embodiment of the jewelry setting according to the present invention provided in a ring;

FIG. 9 is a side view of the jewelry setting of FIG. 8 provided in the ring; and,

FIG. 10 is a perspective view of the jewelry setting of FIG. 8 provided in the ring.

The broken lines are provide for illustrative purposes only and form no part of the claimed design.

1 Claim, 3 Drawing Sheets

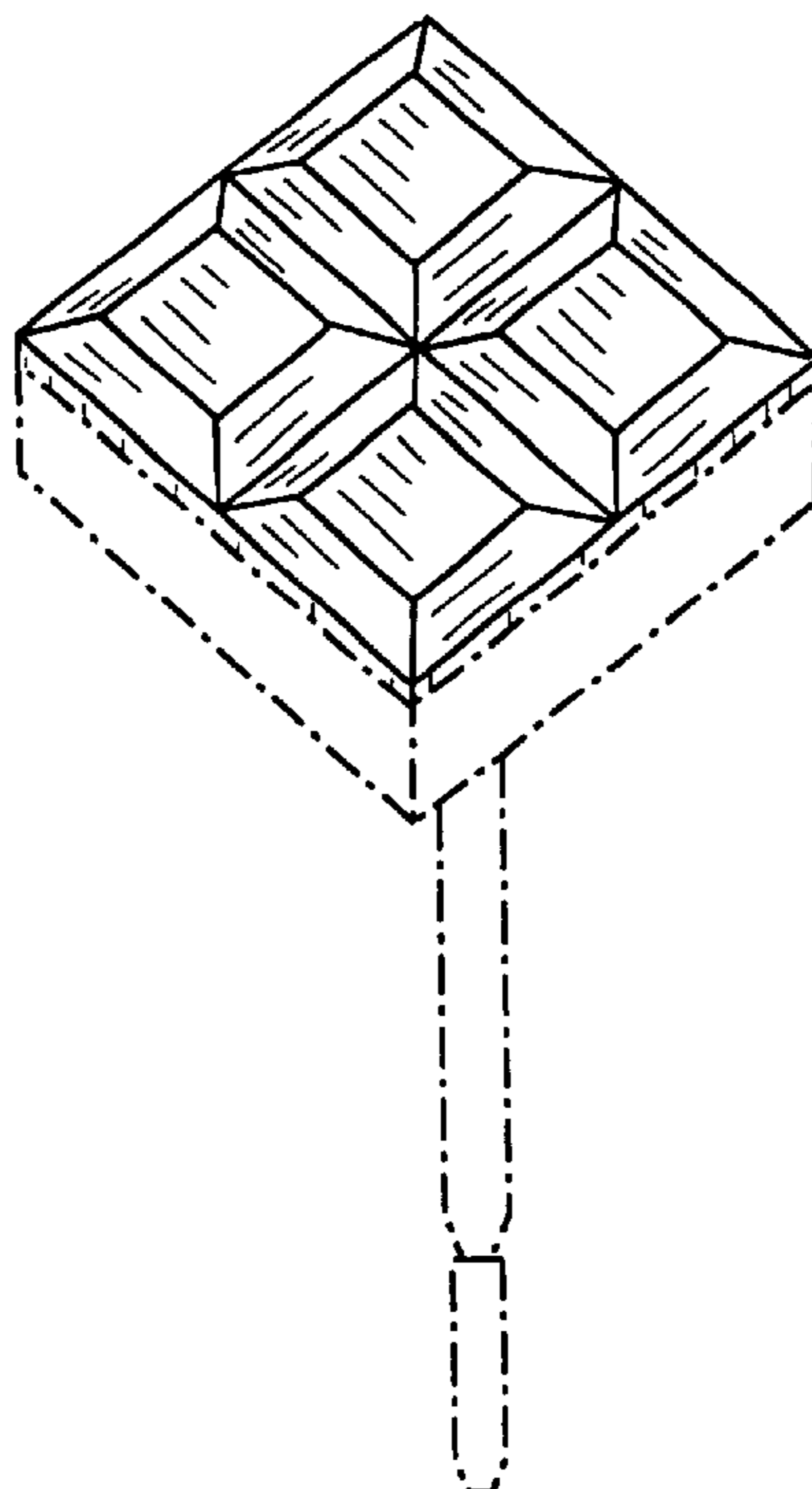

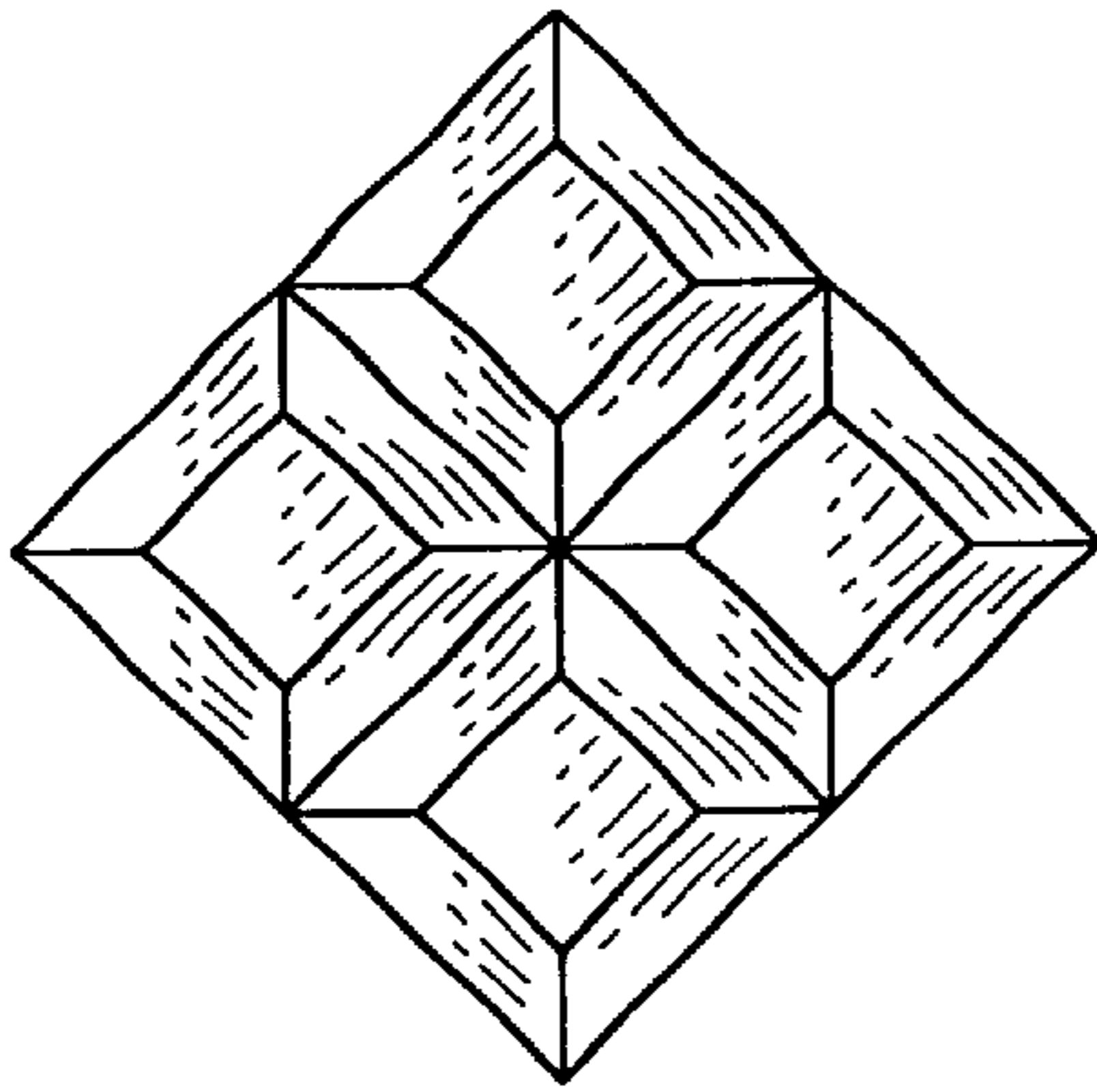

FIG. 1

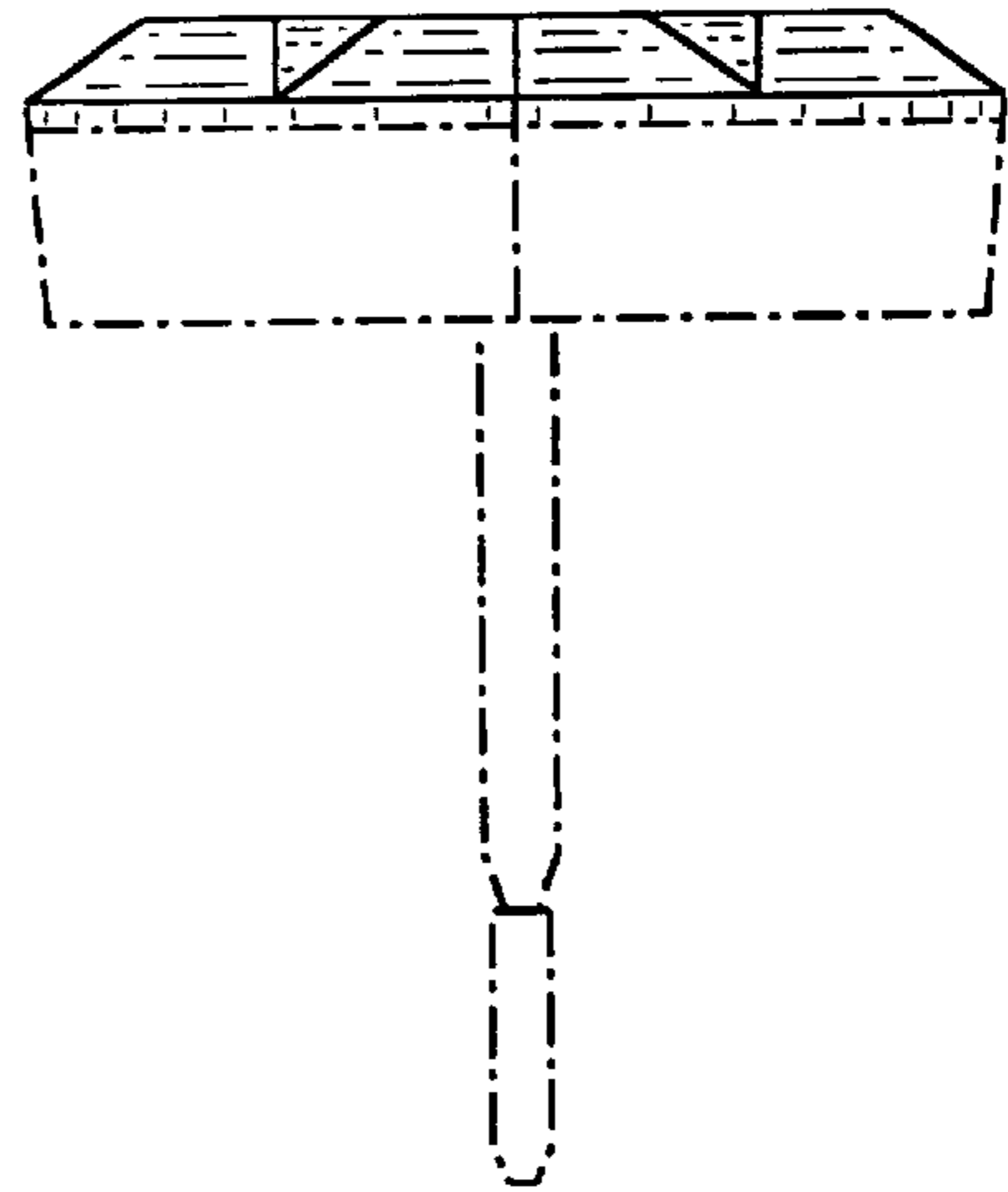

FIG. 2

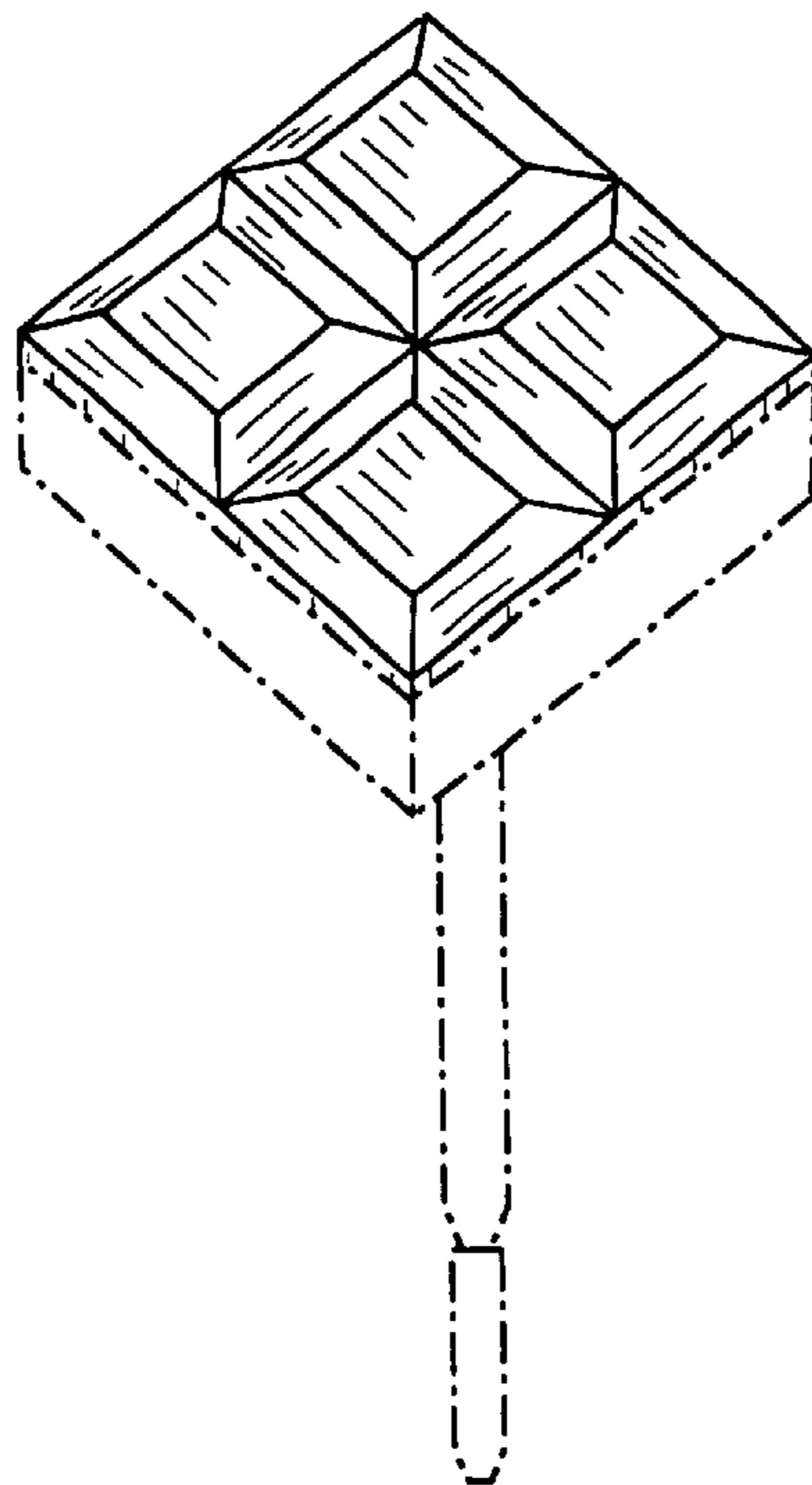

FIG. 3

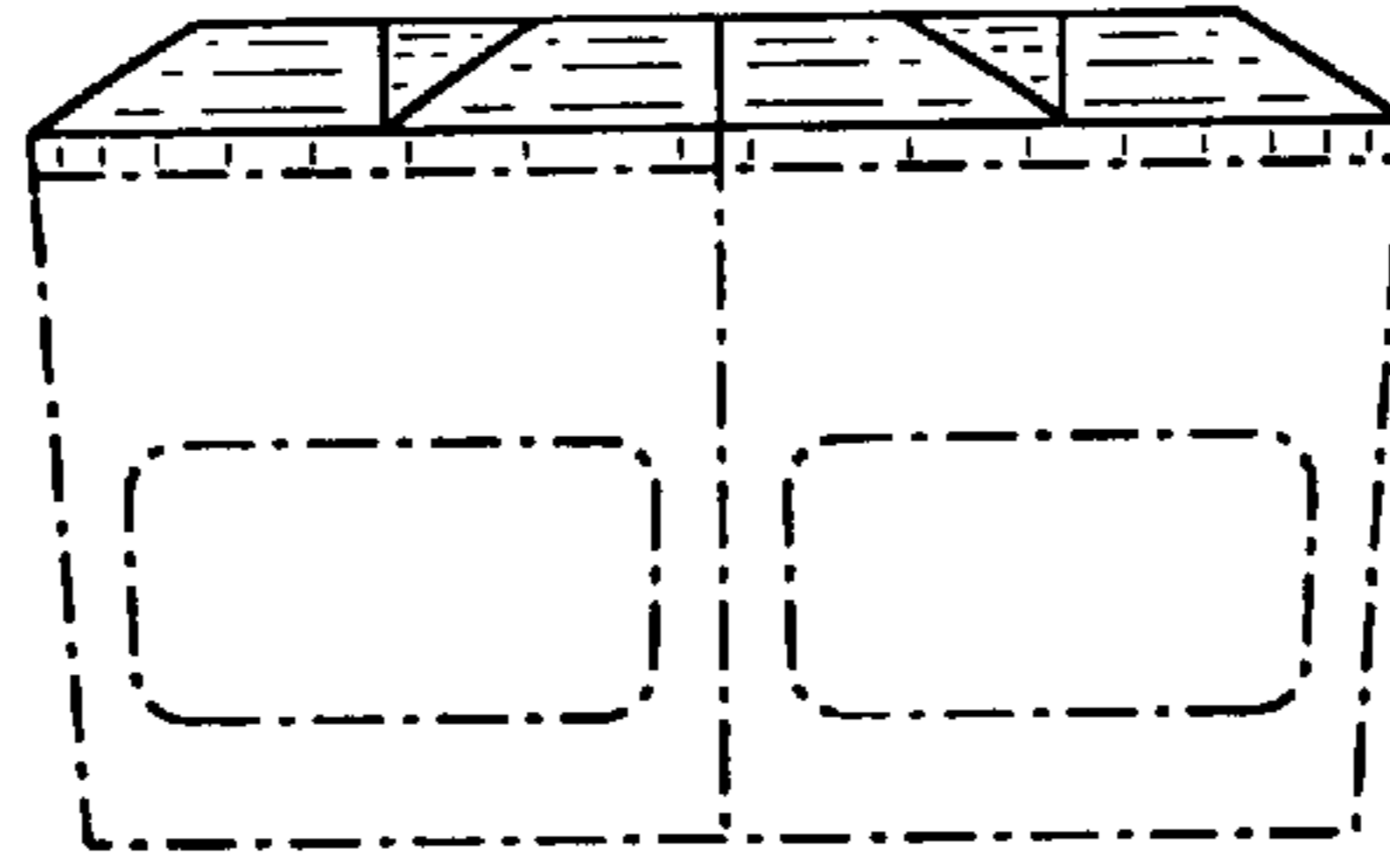

FIG. 4

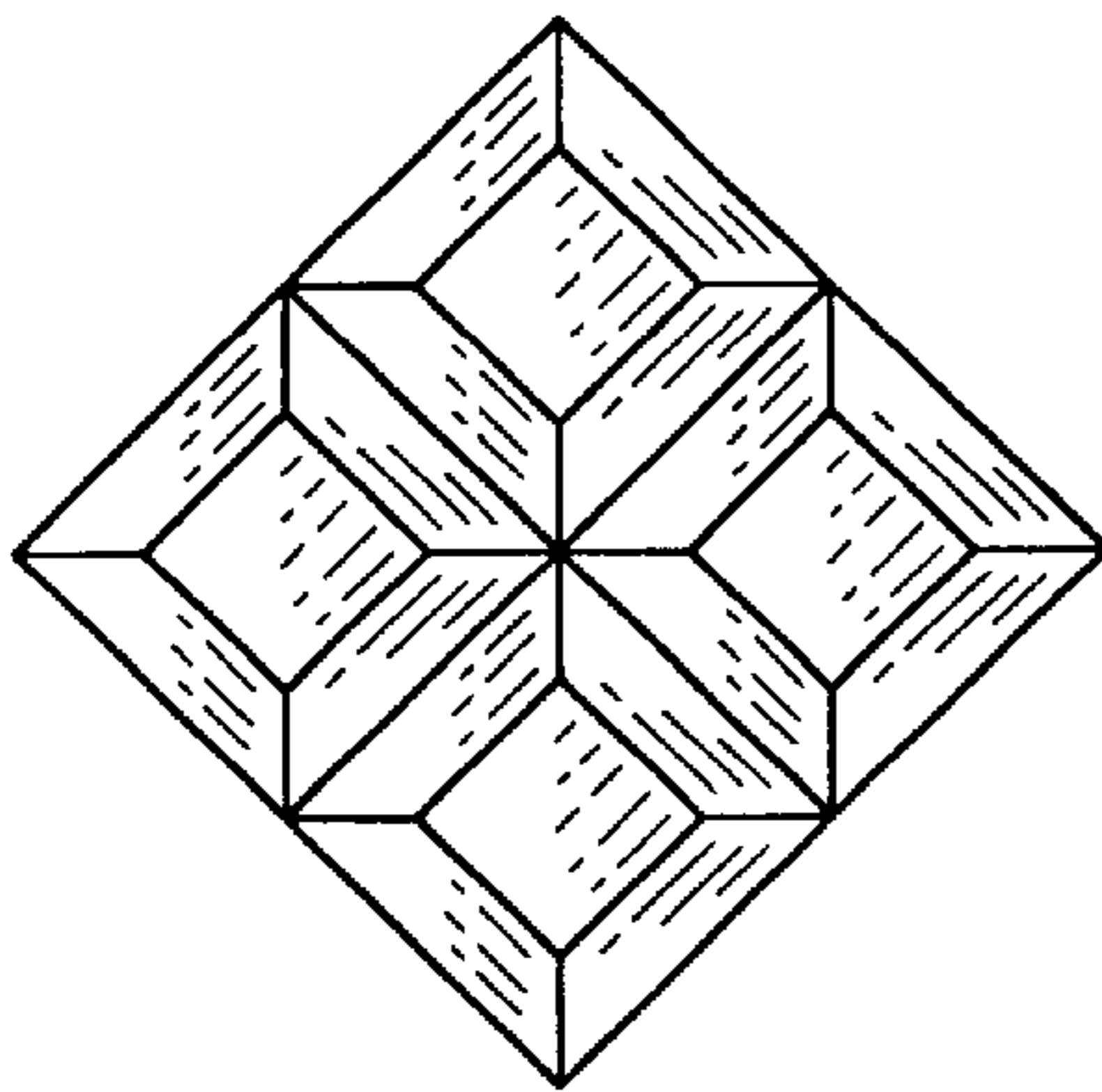

FIG. 5

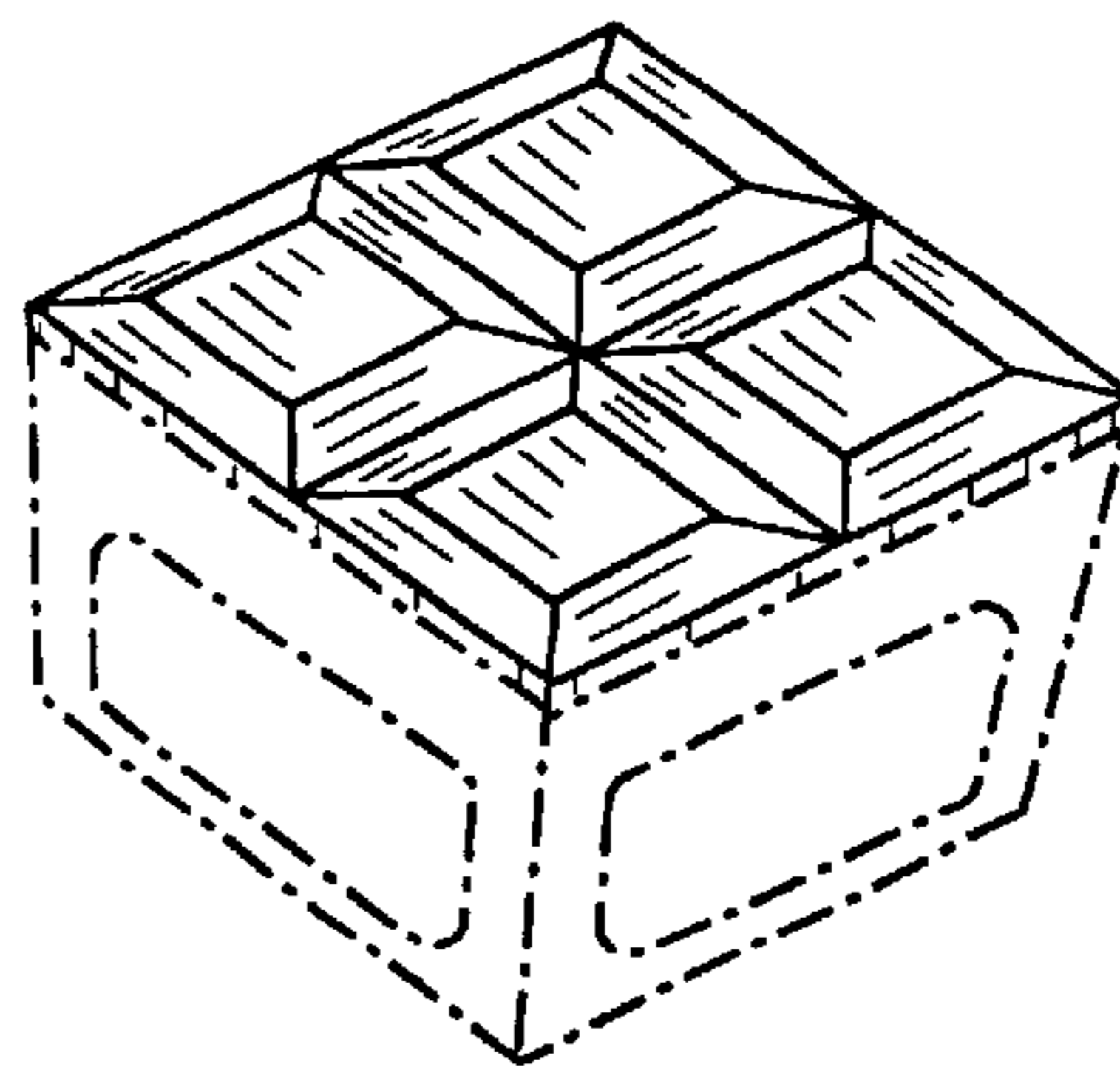

FIG. 6

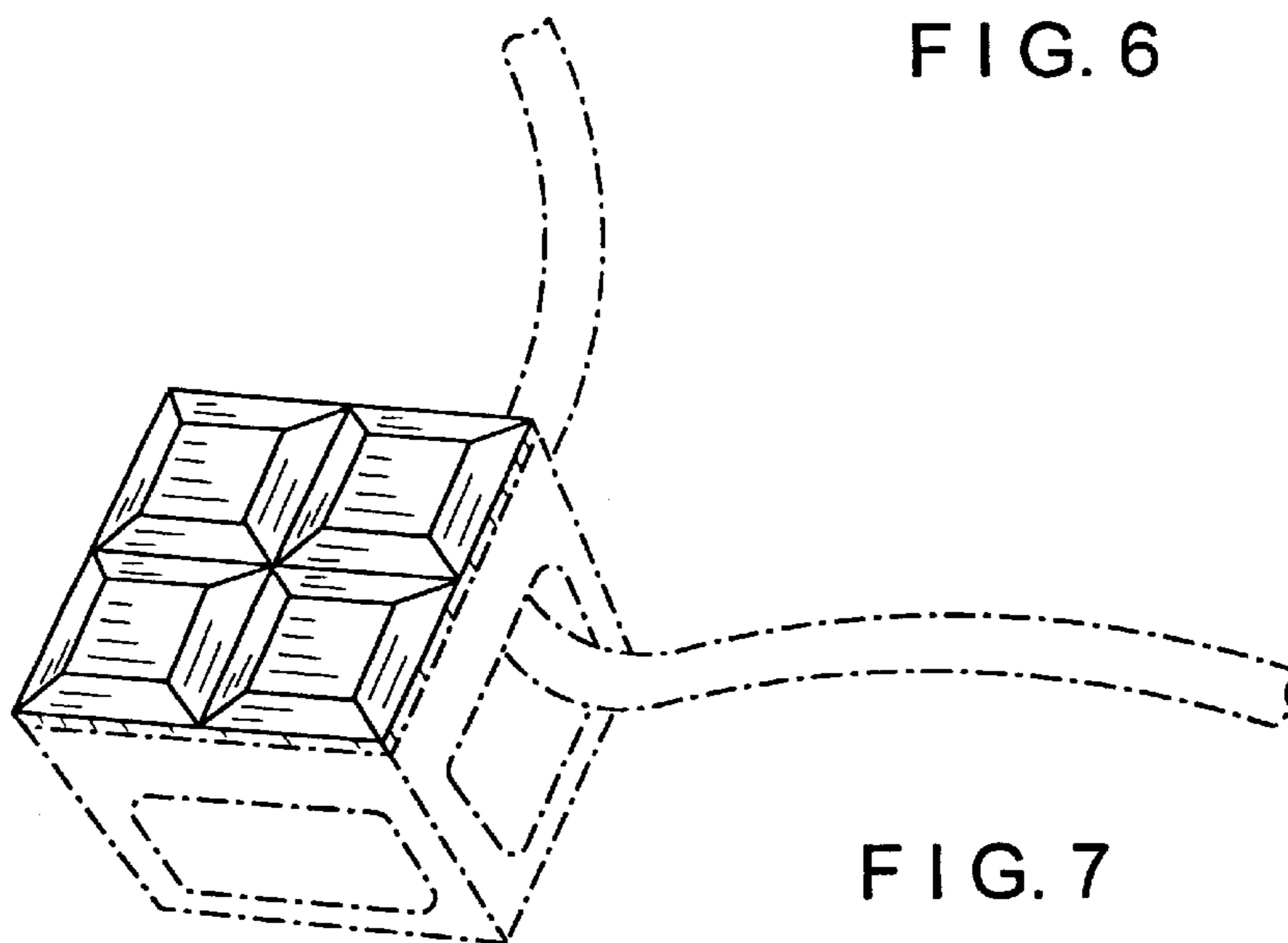

FIG. 7

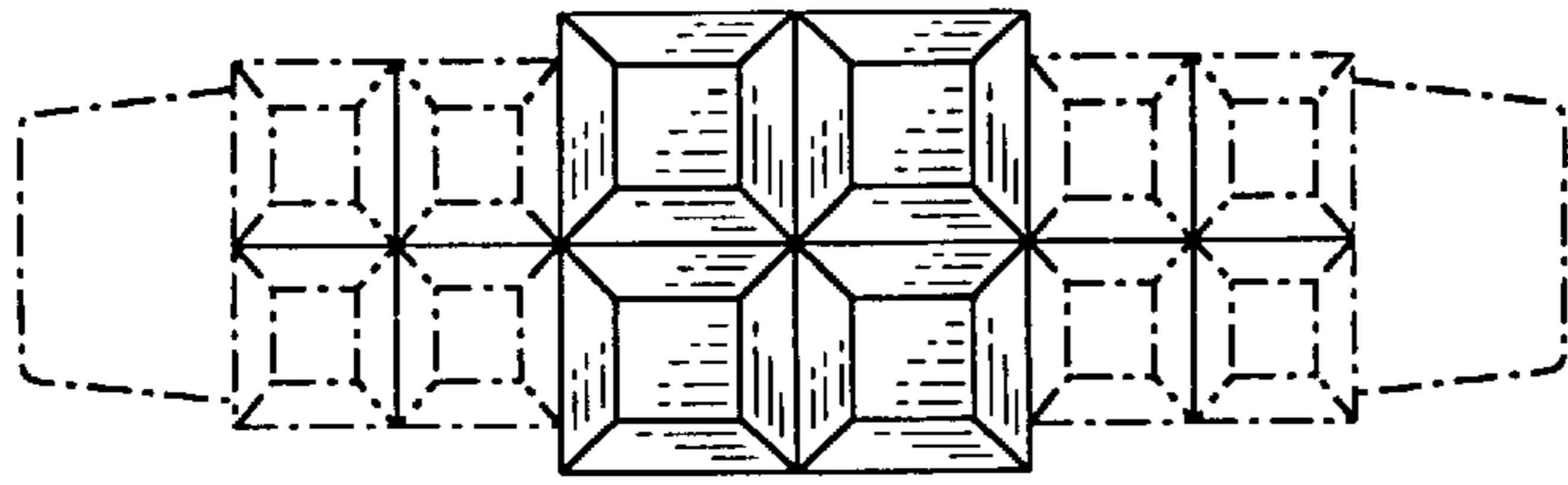

FIG. 8

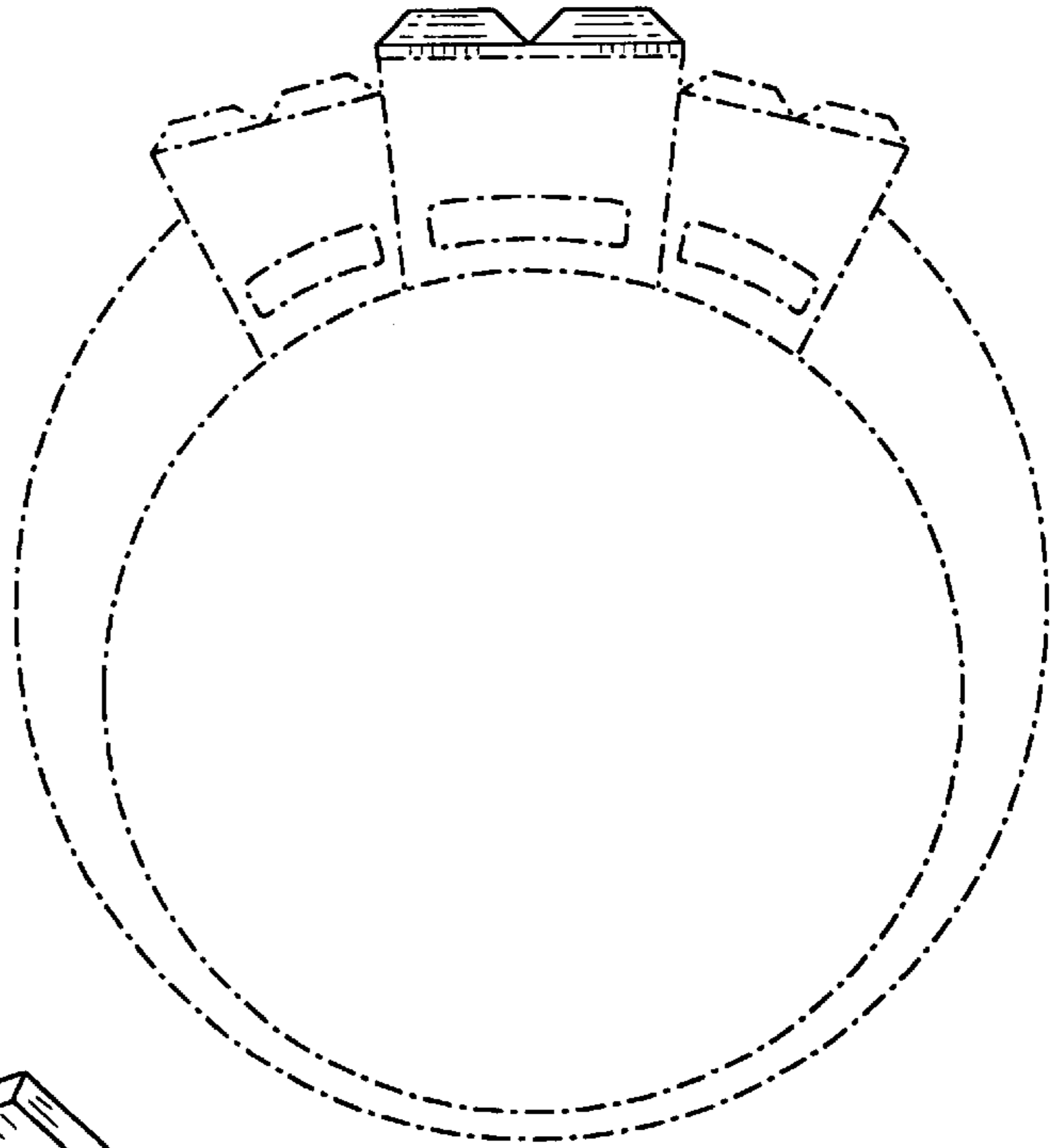

FIG. 9

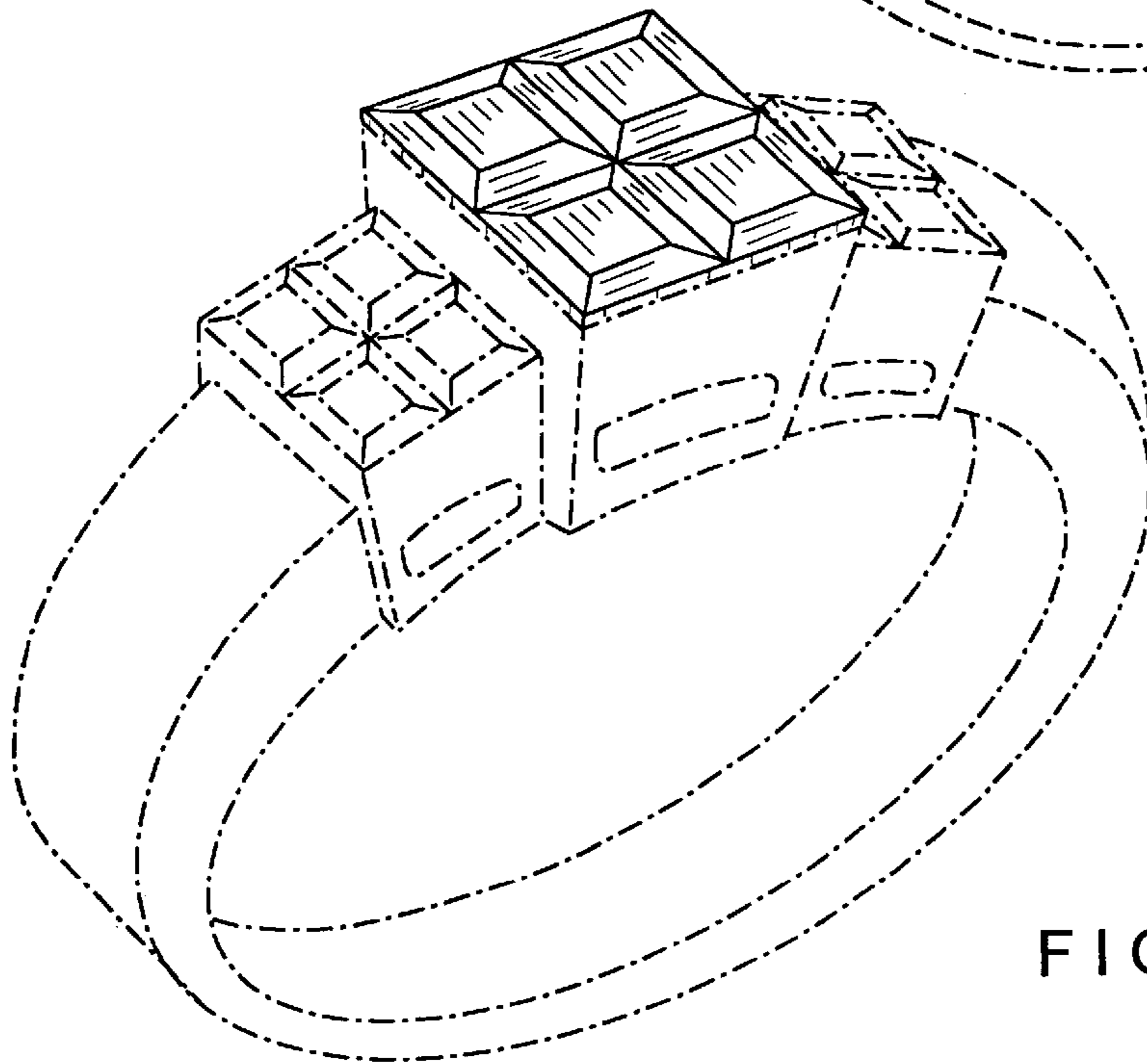

FIG. 10