



US00D453594S

(12) **United States Design Patent**
Ishihara

(10) **Patent No.:** **US D453,594 S**

(45) **Date of Patent:** **** Feb. 12, 2002**

(54) **PET HARNESS**

(75) Inventor: **Kimio Ishihara**, Shizuoka (JP)

(73) Assignee: **C's Ishihara Co., Ltd.**, Shizuoka (JP)

(**) Term: **14 Years**

(21) Appl. No.: **29/116,235**

(22) Filed: **Dec. 30, 1999**

(51) **LOC (7) Cl.** **30-04**

(52) **U.S. Cl.** **D30/152**

(58) **Field of Search** D30/151, 152,
D30/145, 109; 119/850, 907, 725, 771

(56) **References Cited**

U.S. PATENT DOCUMENTS

D312,151 S	*	11/1990	Dickey	D30/145
5,193,486 A	*	3/1993	Kitchens	119/725
5,632,235 A	*	5/1997	Larsen et al.	119/856
5,894,817 A	*	4/1999	Manuel	119/497

* cited by examiner

Primary Examiner—Pamela Burgess

(74) *Attorney, Agent, or Firm*—Young & Thompson

(57) **CLAIM**

The ornamental design for a pet harness, as shown and described.

DESCRIPTION

FIG. 1 is a top plan view of a pet harness showing my new design;
 FIG. 2 is a front elevational view thereof;
 FIG. 3 is a bottom plan view thereof;
 FIG. 4 is a side elevational view from the right of FIG. 1;
 FIG. 5 is a rear elevational view thereof;
 FIG. 6 is a side elevational view from the left of FIG. 1;
 FIG. 7 is a right side elevational view shown in use;
 FIG. 8 is a front elevational view shown in use; and,
 FIG. 9 is a front elevational view shown in use, the broken lines are for illustrative purposes only and form no part of the claimed design.

1 Claim, 4 Drawing Sheets

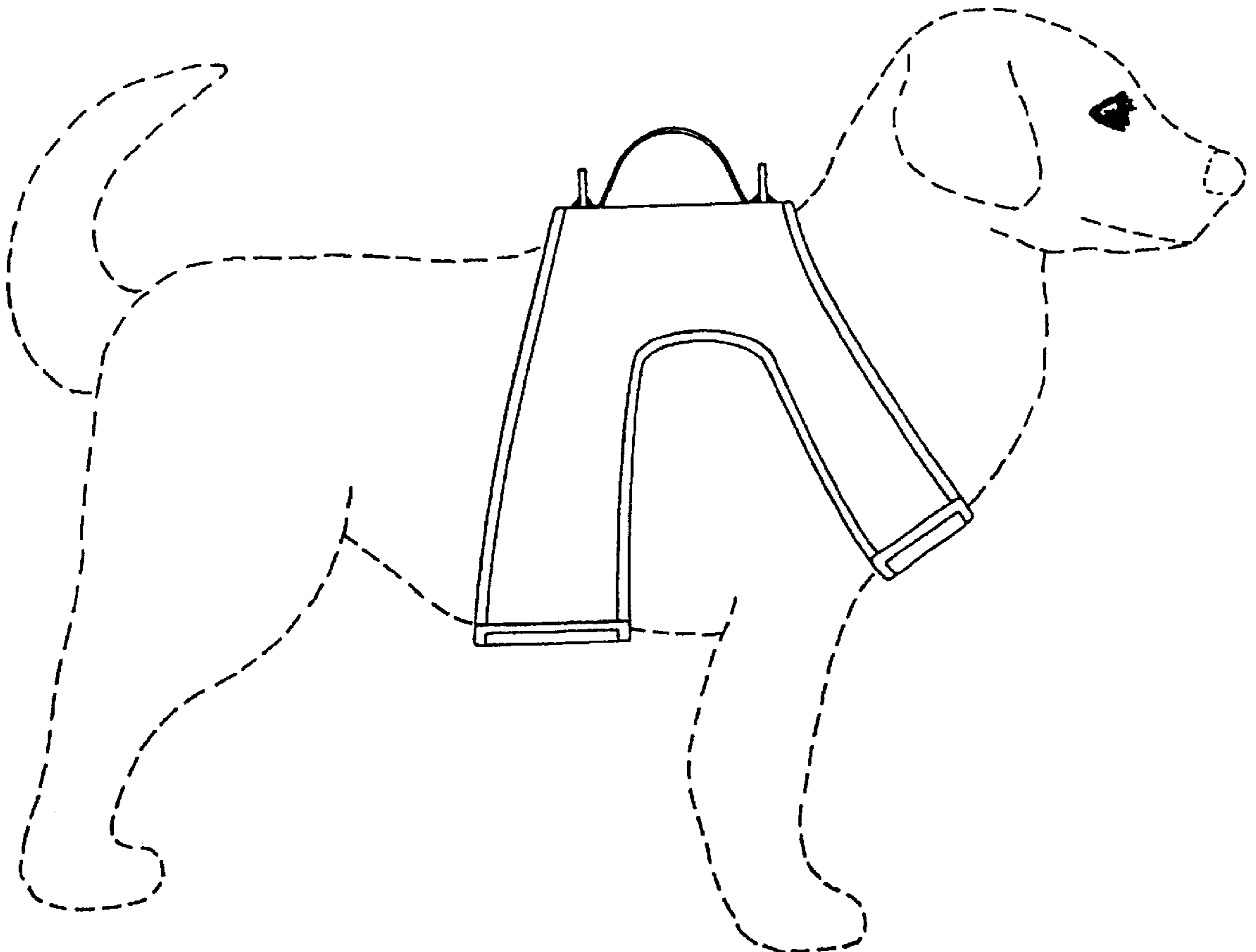

Fig. 1

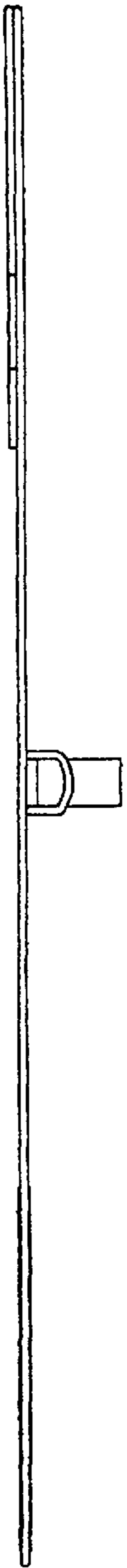

Fig. 2

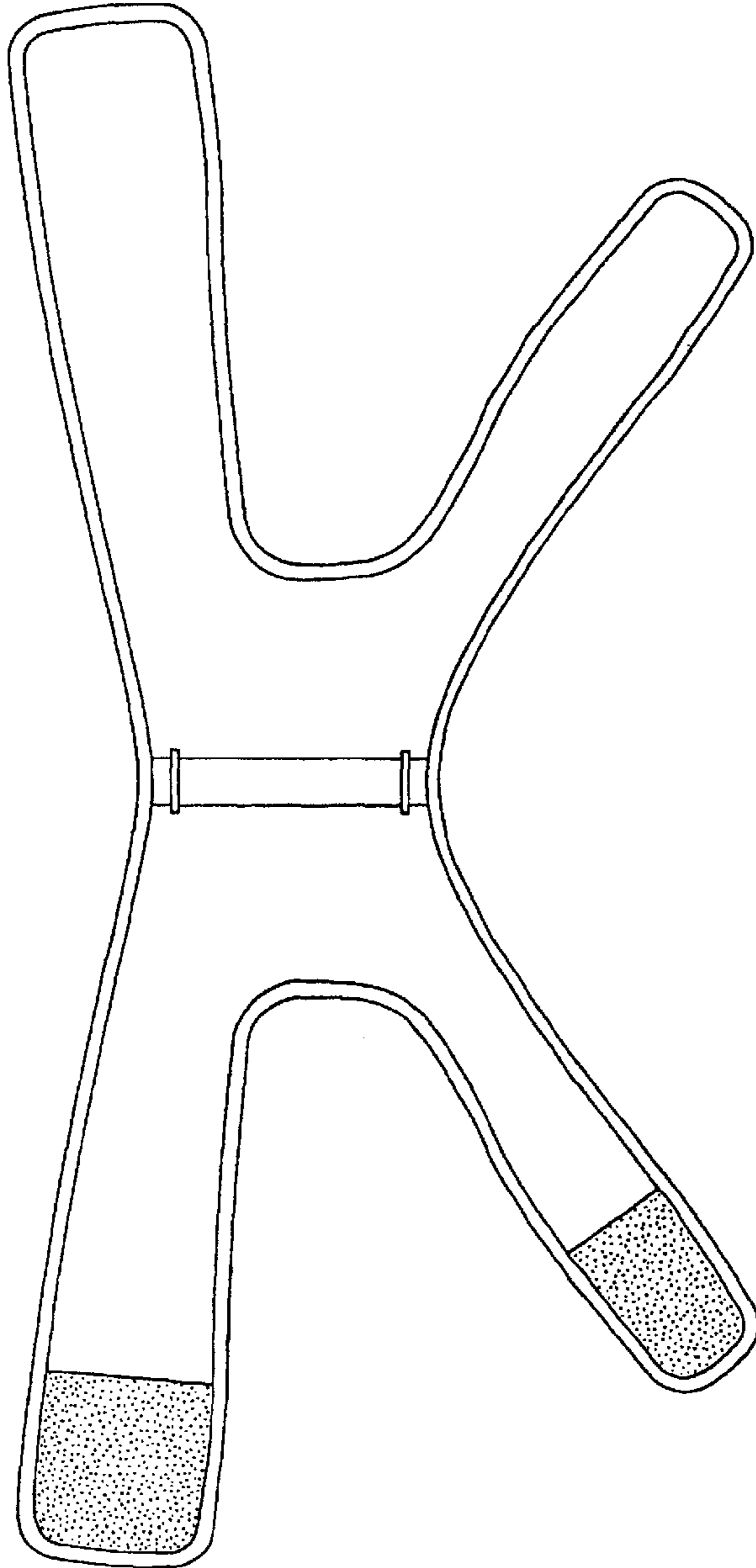

Fig. 4



Fig. 3

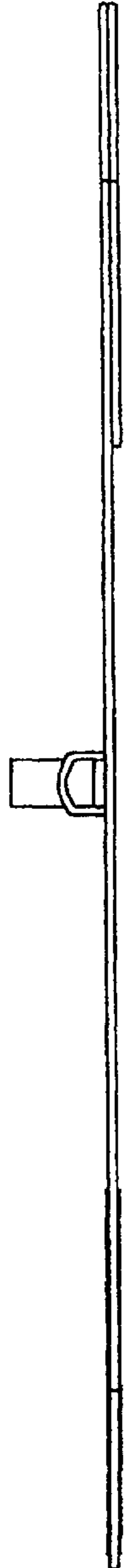

Fig. 5

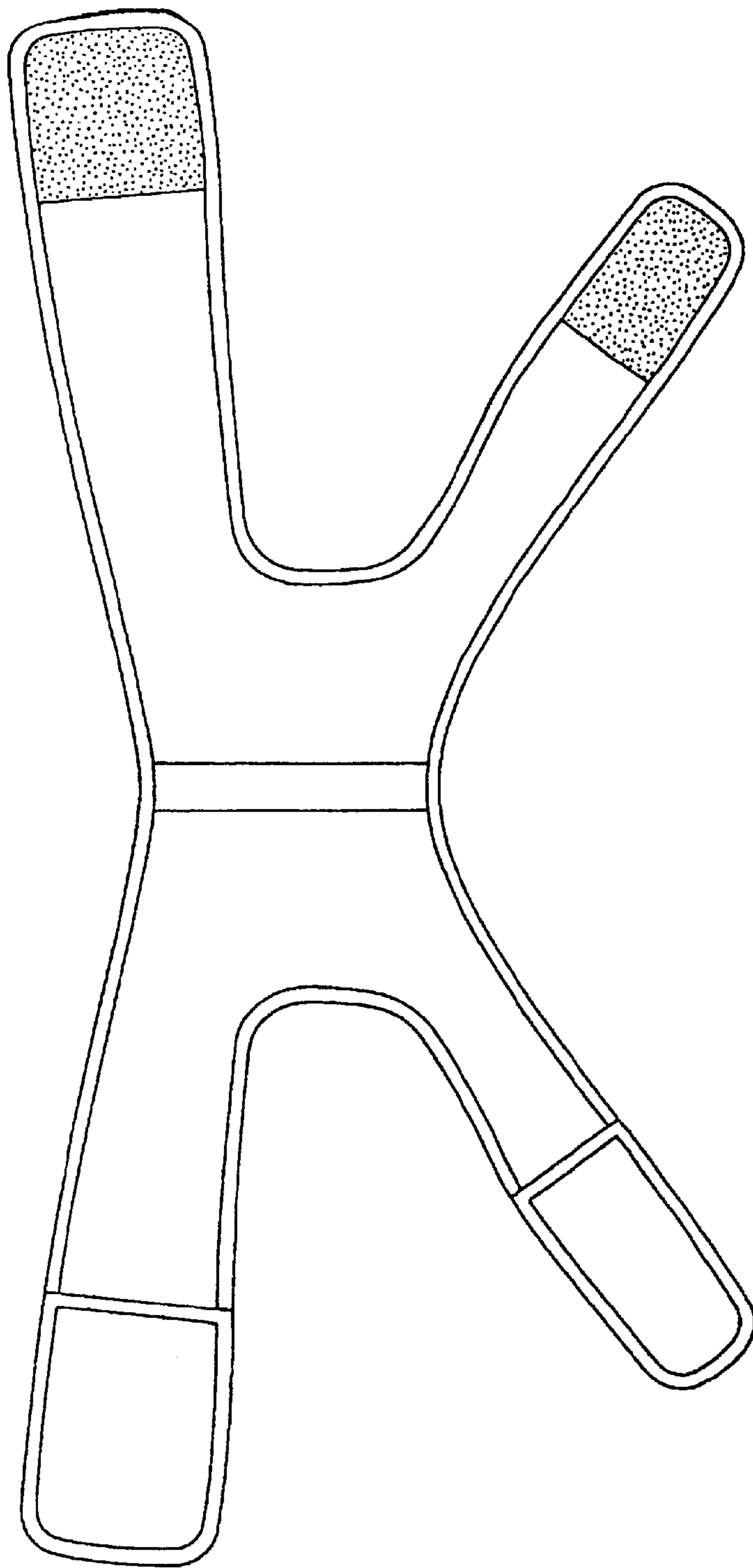

Fig. 6

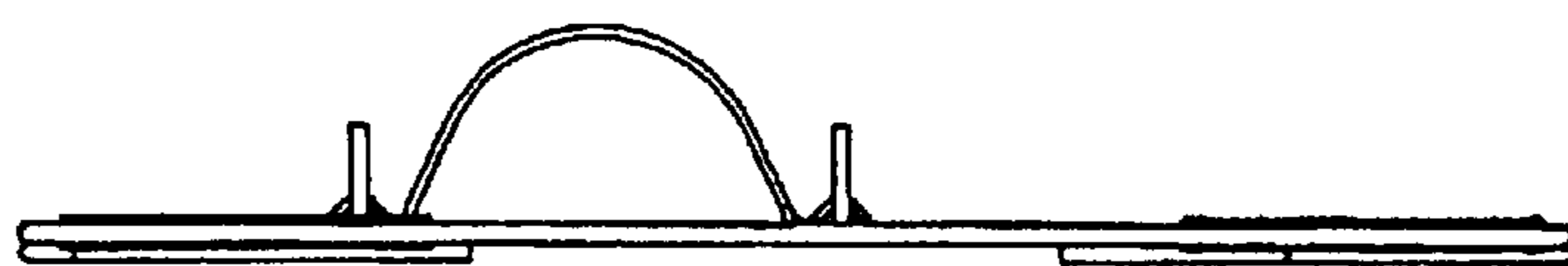

Fig. 7

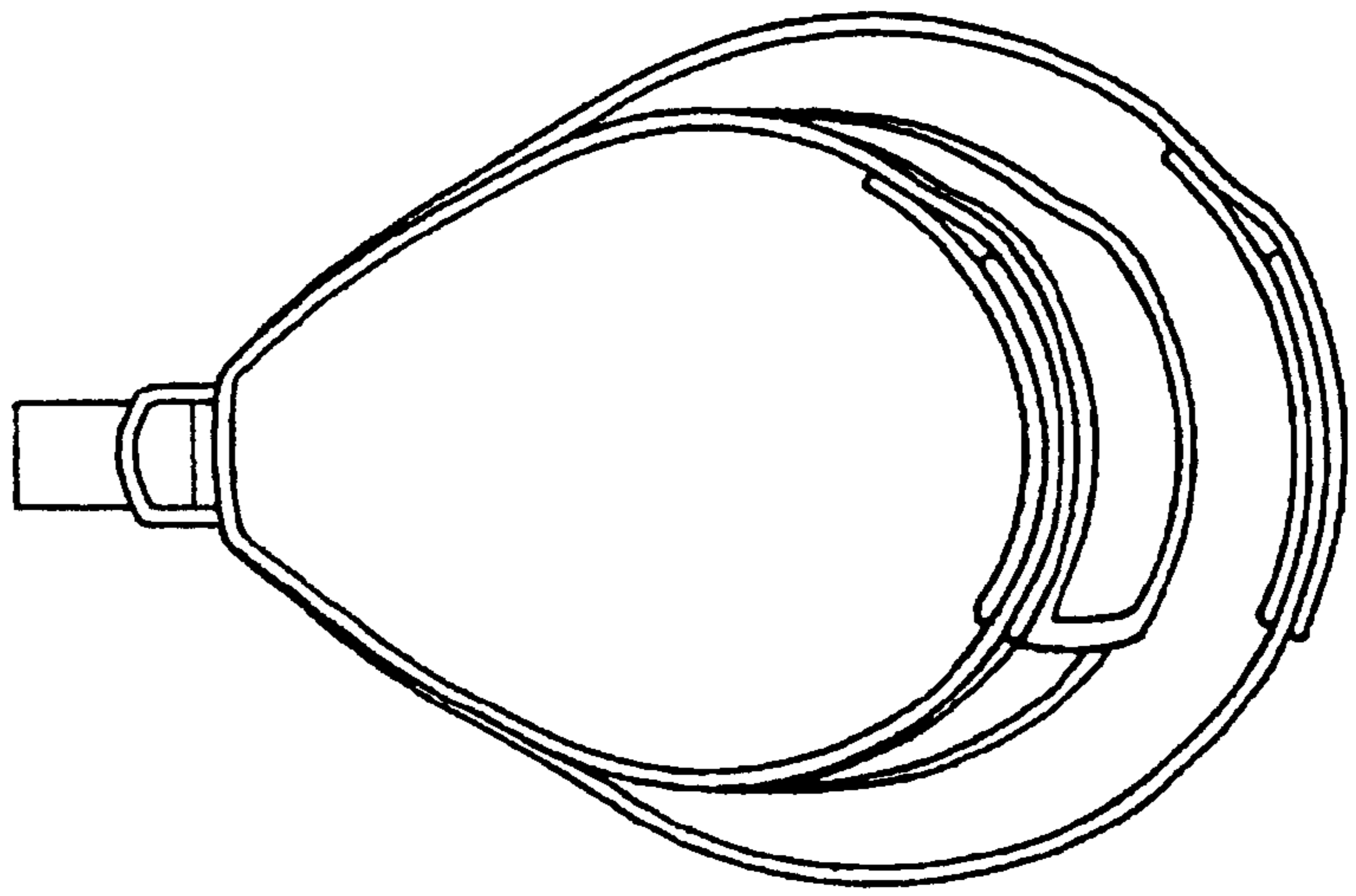

Fig. 8

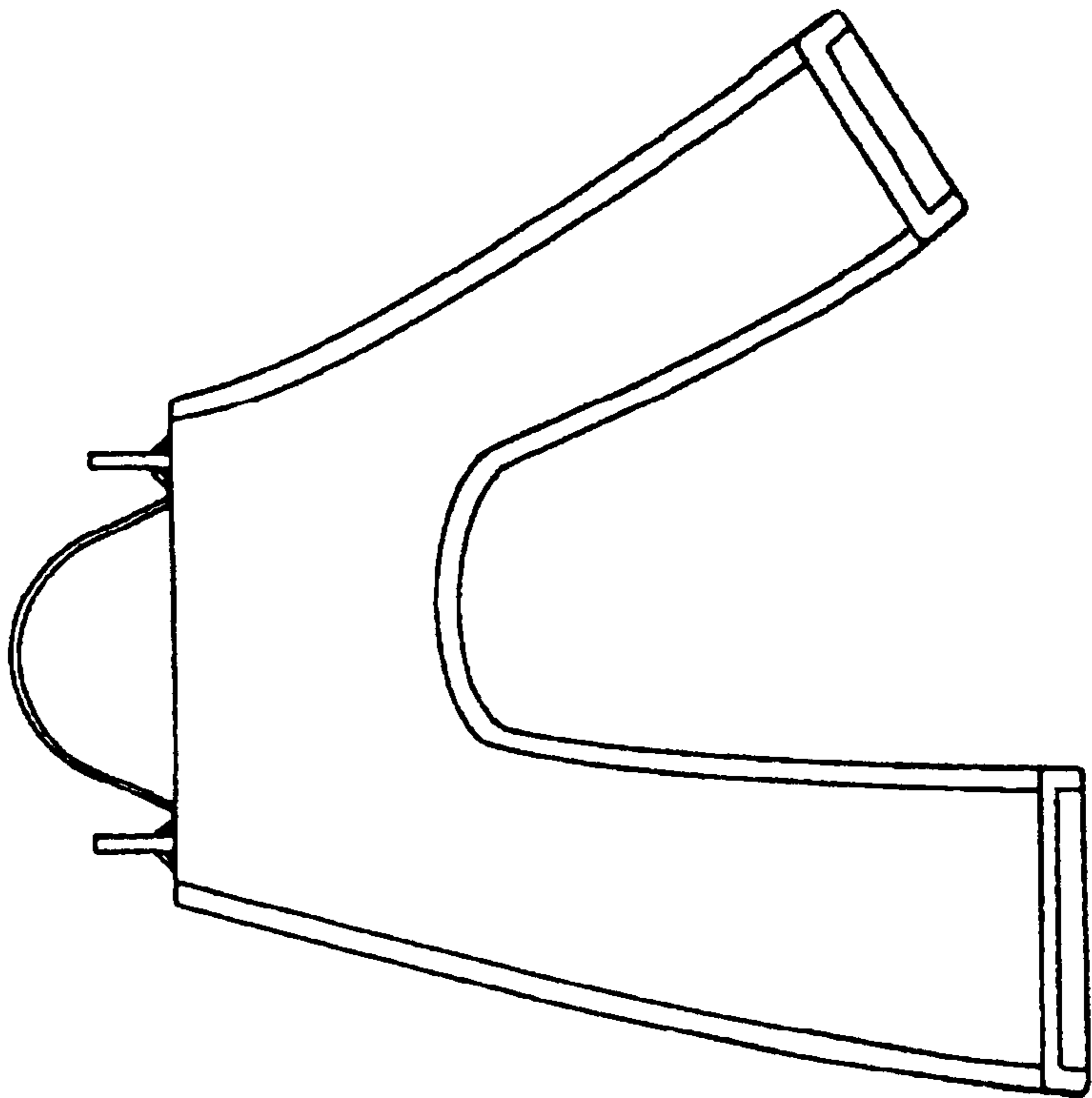

Fig. 9

