



US00D453515S

(12) **United States Design Patent**
Brewer et al.

(10) **Patent No.:** **US D453,515 S**

(45) **Date of Patent:** **** Feb. 12, 2002**

(54) **ELECTRONIC MEMORY CARD HOLDER**

(75) Inventors: **Wesley G. Brewer**, Los Gatos; **Robert F. Wallace**, Sunnyvale; **Robert C. Miller**, San Jose, all of CA (US)

(73) Assignee: **SanDisk Corporation**, Sunnyvale, CA (US)

(**) Term: **14 Years**

(21) Appl. No.: **29/132,354**

(22) Filed: **Nov. 6, 2000**

(51) **LOC (7) Cl.** **14-02**

(52) **U.S. Cl.** **D14/436; D14/435**

(58) **Field of Search** D14/435, 436, D14/432, 433; 283/75.6, 77, 75, 904, 900; 361/684, 685, 686

(56) **References Cited**

U.S. PATENT DOCUMENTS

4,141,400 A	*	2/1979	Mangan	283/904
D375,304 S	*	11/1996	Takahata et al.	D14/435
D412,160 S	*	7/1999	Nelson	D14/435
6,040,622 A		3/2000	Wallace		
6,112,996 A		9/2000	Matsuo		
D444,789 S	*	7/2001	Obata	D14/436
D445,096 S		7/2001	Wallace		

* cited by examiner

Primary Examiner—Kay H. Chin

(74) *Attorney, Agent, or Firm*—Skjerven Morrill MacPherson LLP

(57) **CLAIM**

The ornamental design for an electronic memory card holder, as shown and described.

DESCRIPTION

FIG. 1 is a top and front perspective view of an electronic memory card holder showing our new design;
 FIG. 2 is a top plan view thereof;
 FIG. 3 is a side elevational view thereof, the opposite side view being a mirror image of that shown;
 FIG. 4 is a bottom plan view thereof;
 FIG. 5 is a rear elevational view thereof;
 FIG. 6 is a front elevational view thereof;
 FIG. 7 is a top and front perspective view of a second embodiment of the electronic memory card holder;
 FIG. 8 is a top plan view of FIG. 7;
 FIG. 9 is a side elevational view of FIG. 7, the opposite side view being a mirror image of that shown;
 FIG. 10 is a bottom plan view of FIG. 7;
 FIG. 11 is a rear elevational view of FIG. 7;
 FIG. 12 is a front elevational view of FIG. 7;
 FIG. 13 is a top and front perspective view of a third embodiment of the electronic memory card holder;
 FIG. 14 is a top plan view of FIG. 13;
 FIG. 15 is a side elevational view of FIG. 13, the opposite side view being a mirror image of that shown;
 FIG. 16 is a bottom plan view of FIG. 13;
 FIG. 17 is a rear elevational view of FIG. 13; and,
 FIG. 18 is a front elevational view of FIG. 13.

1 Claim, 3 Drawing Sheets

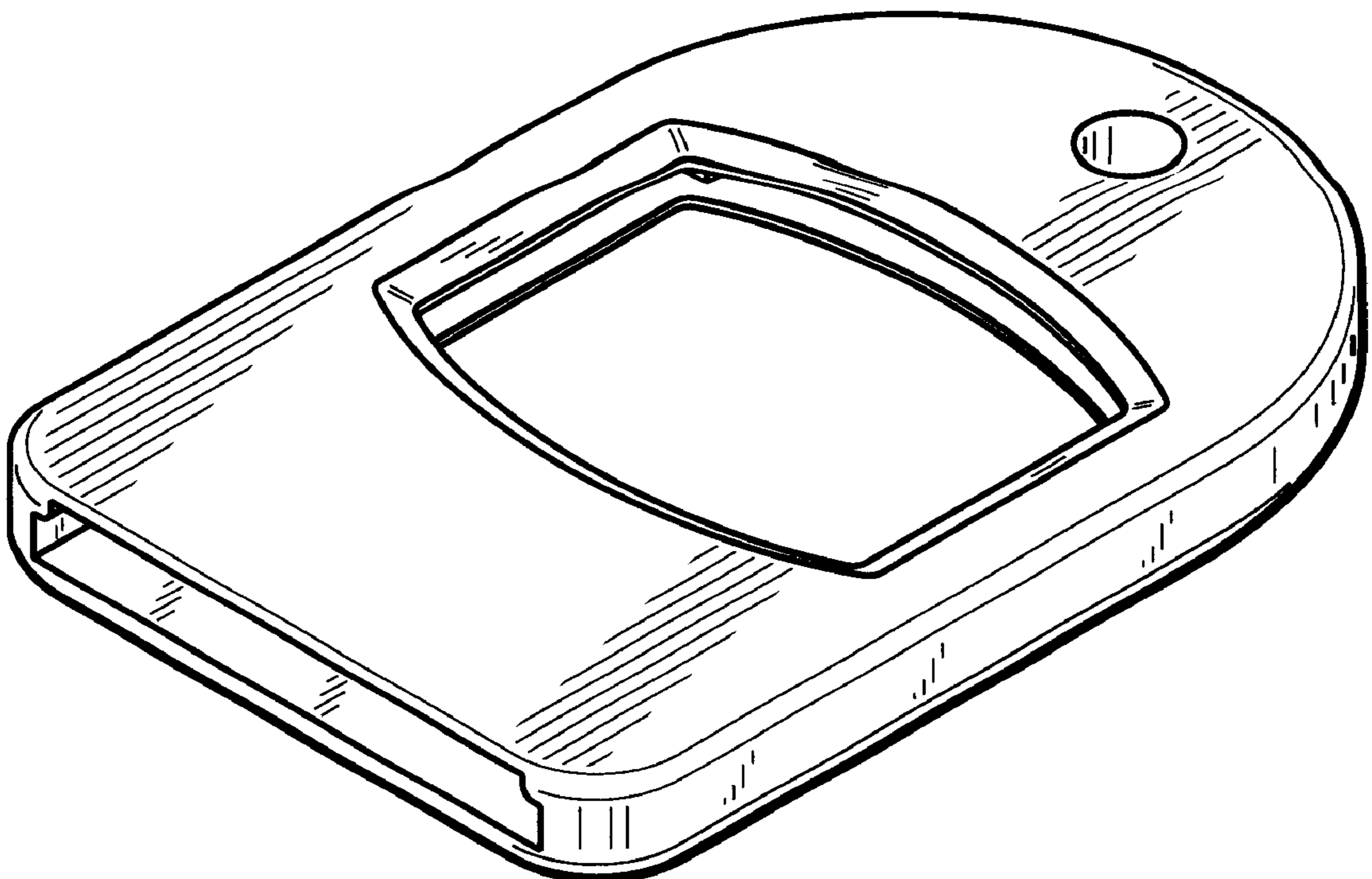

FIG._1

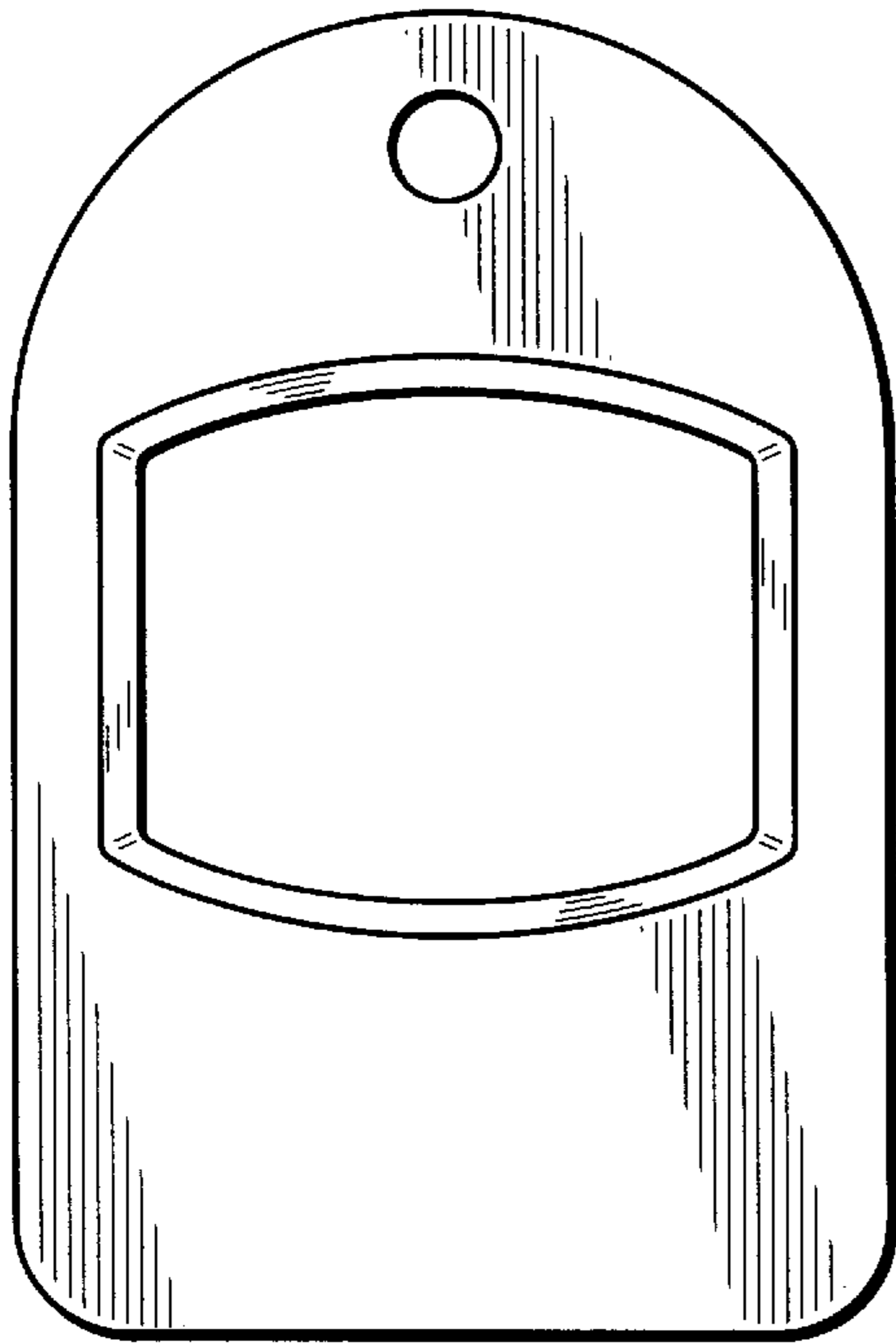
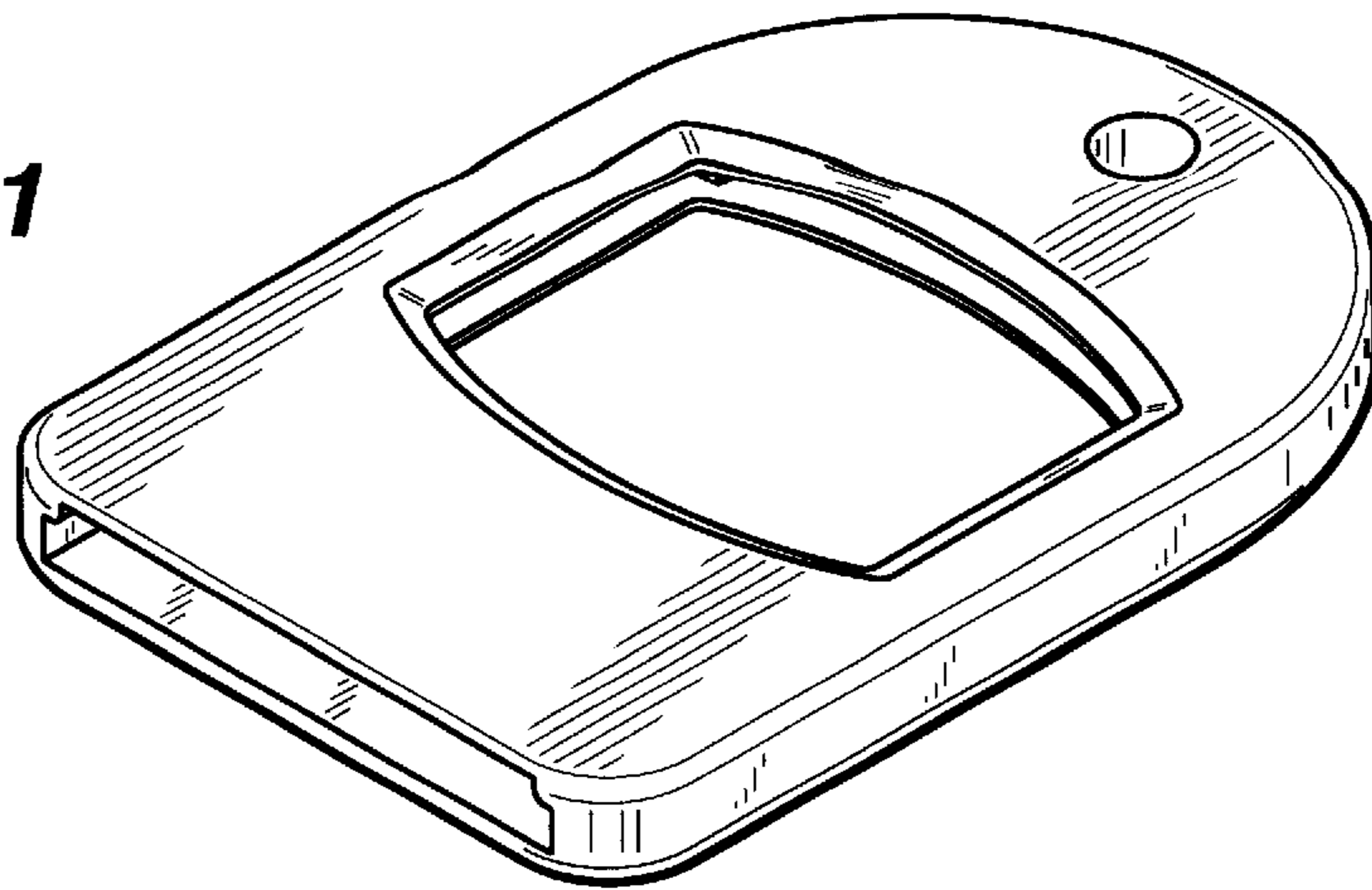

FIG._2

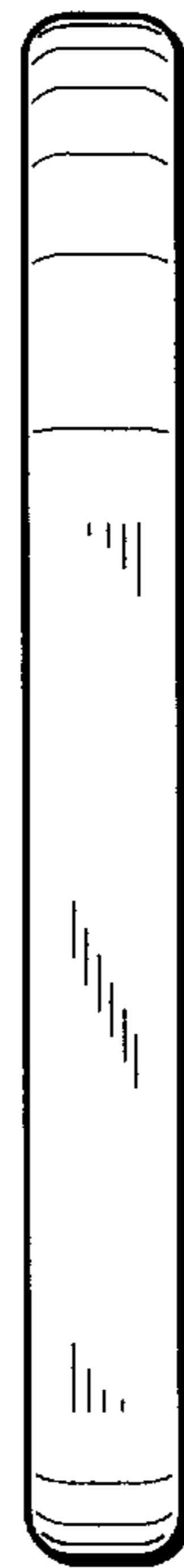

FIG._3

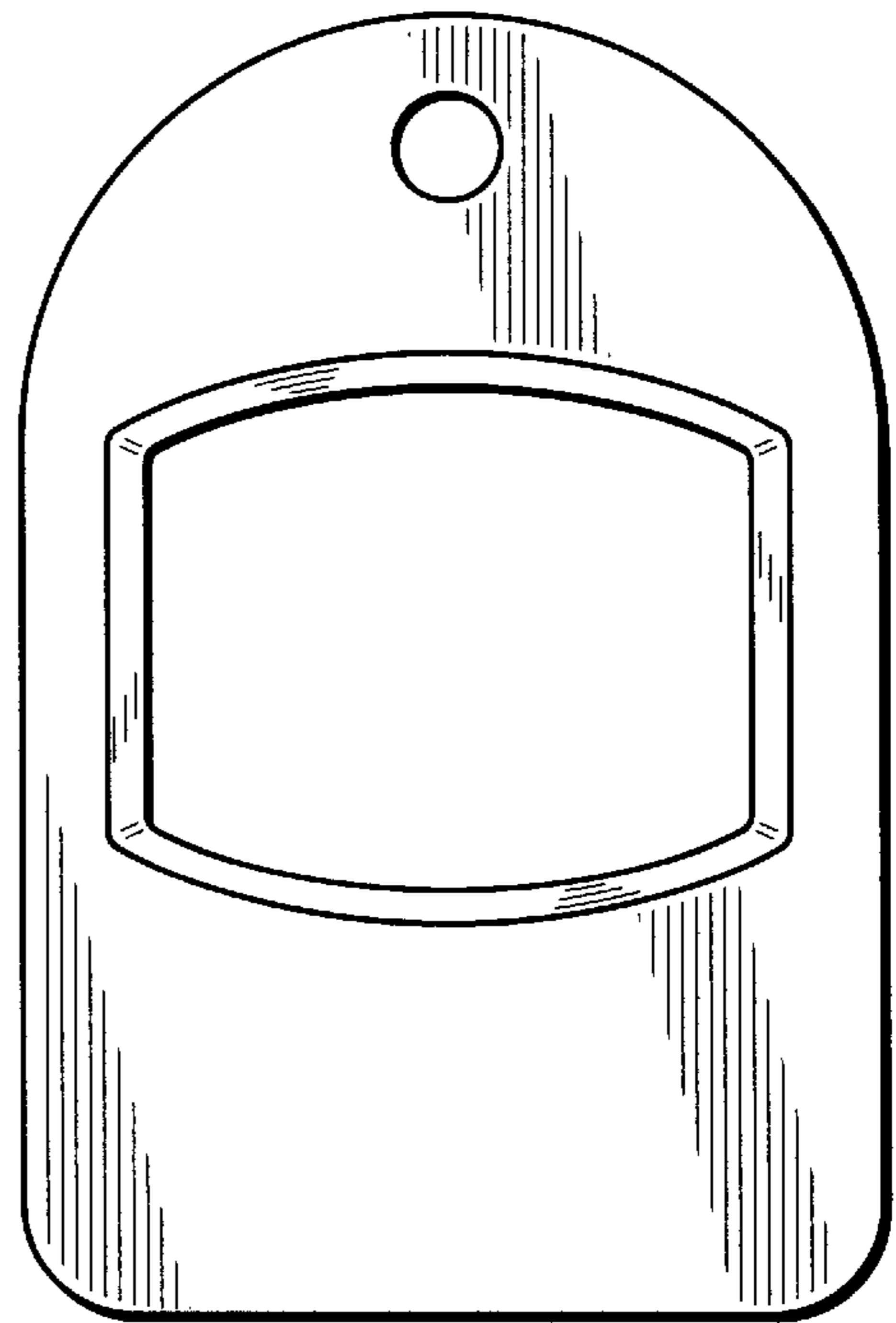

FIG._4



FIG._5

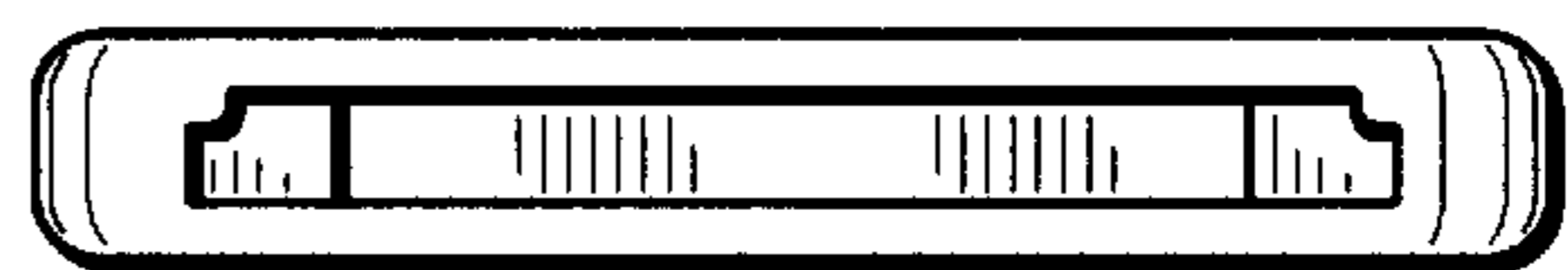

FIG._6

FIG._7

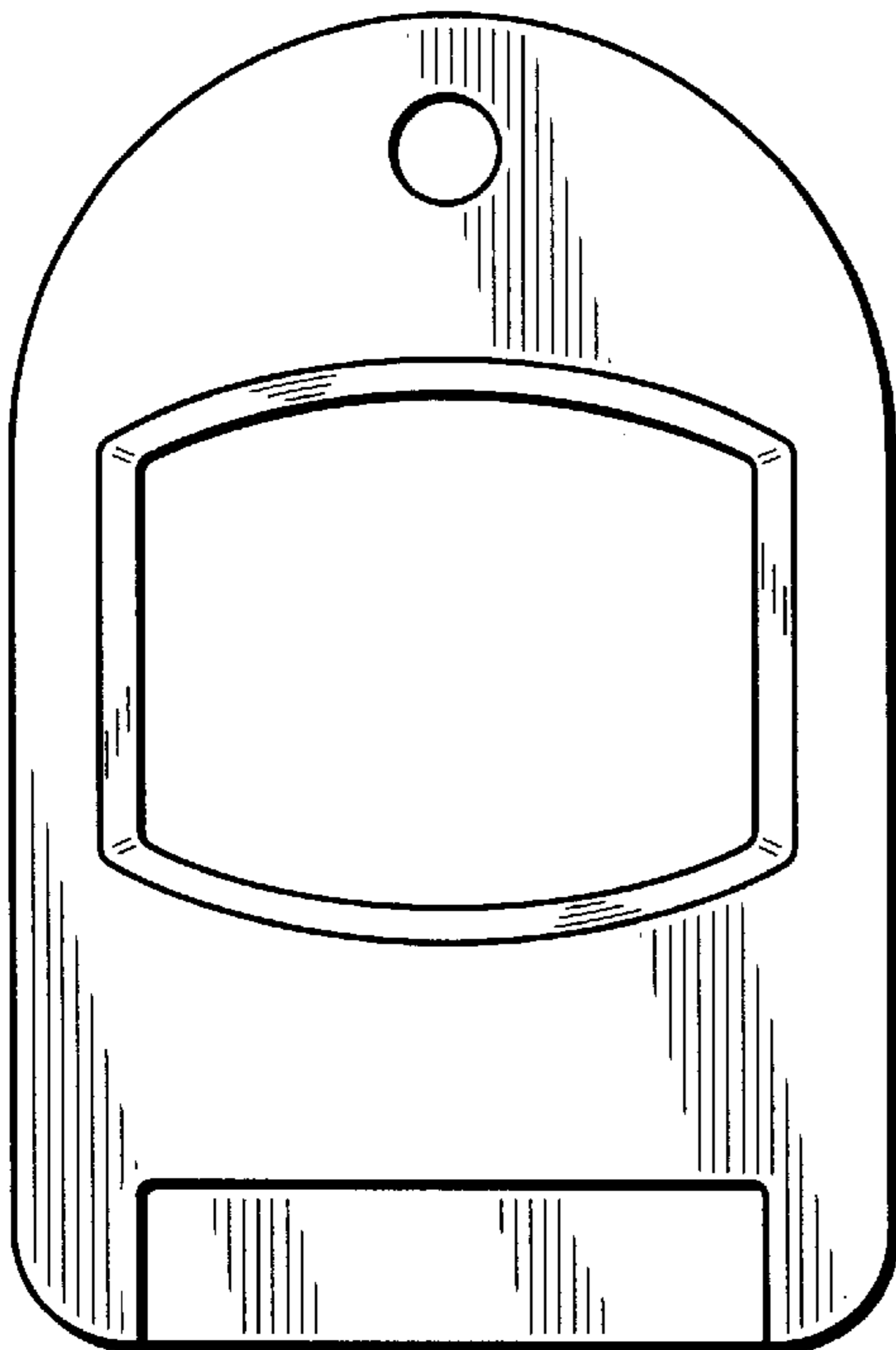
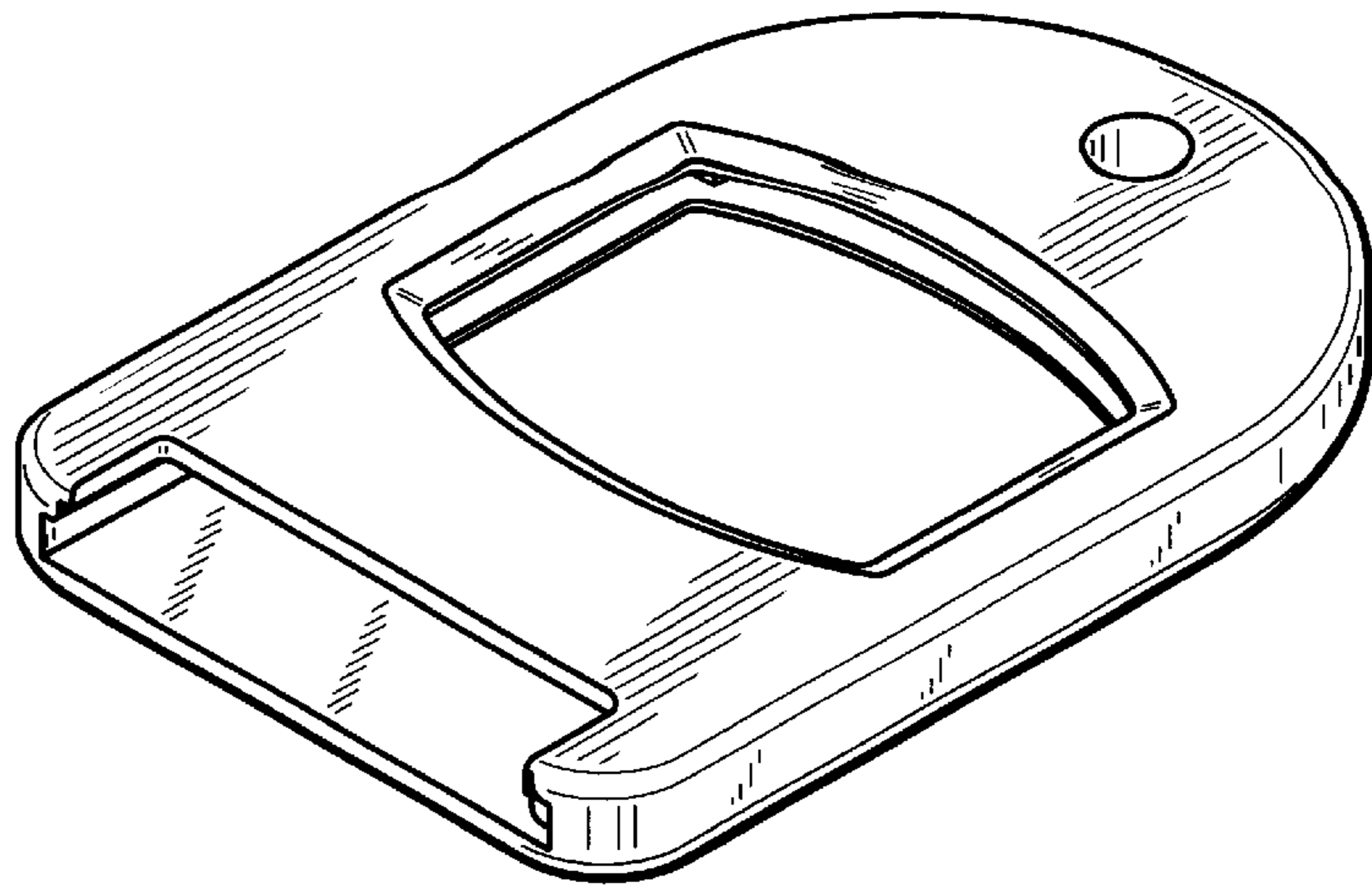

FIG._8

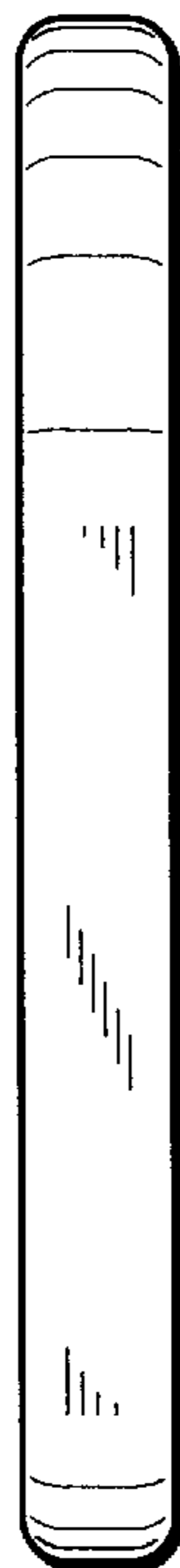

FIG._9

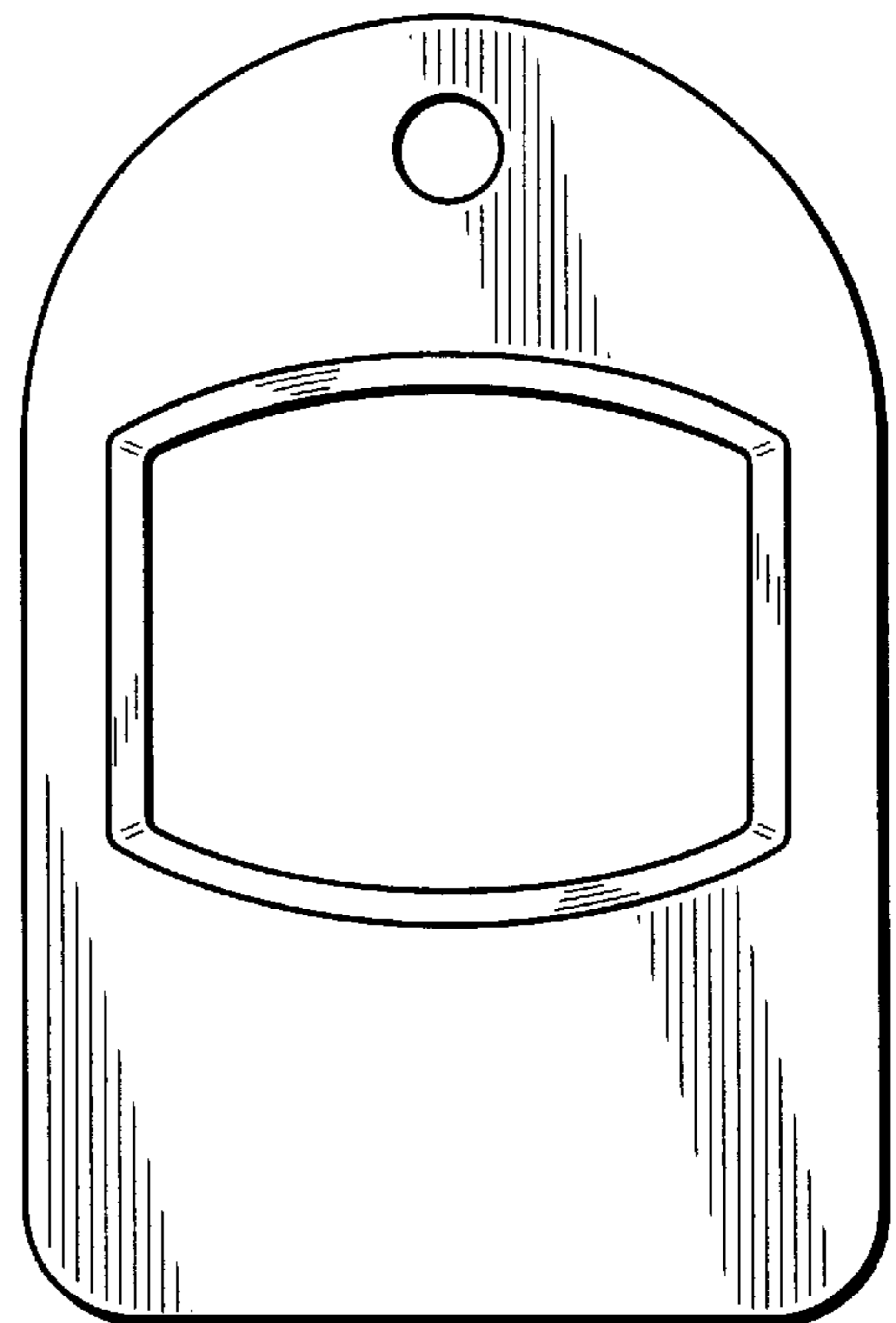

FIG._10



FIG._11

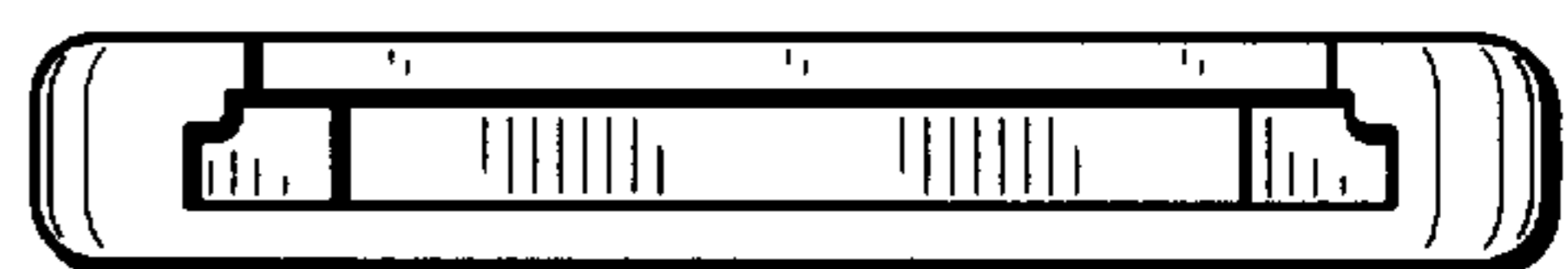

FIG._12

FIG._13

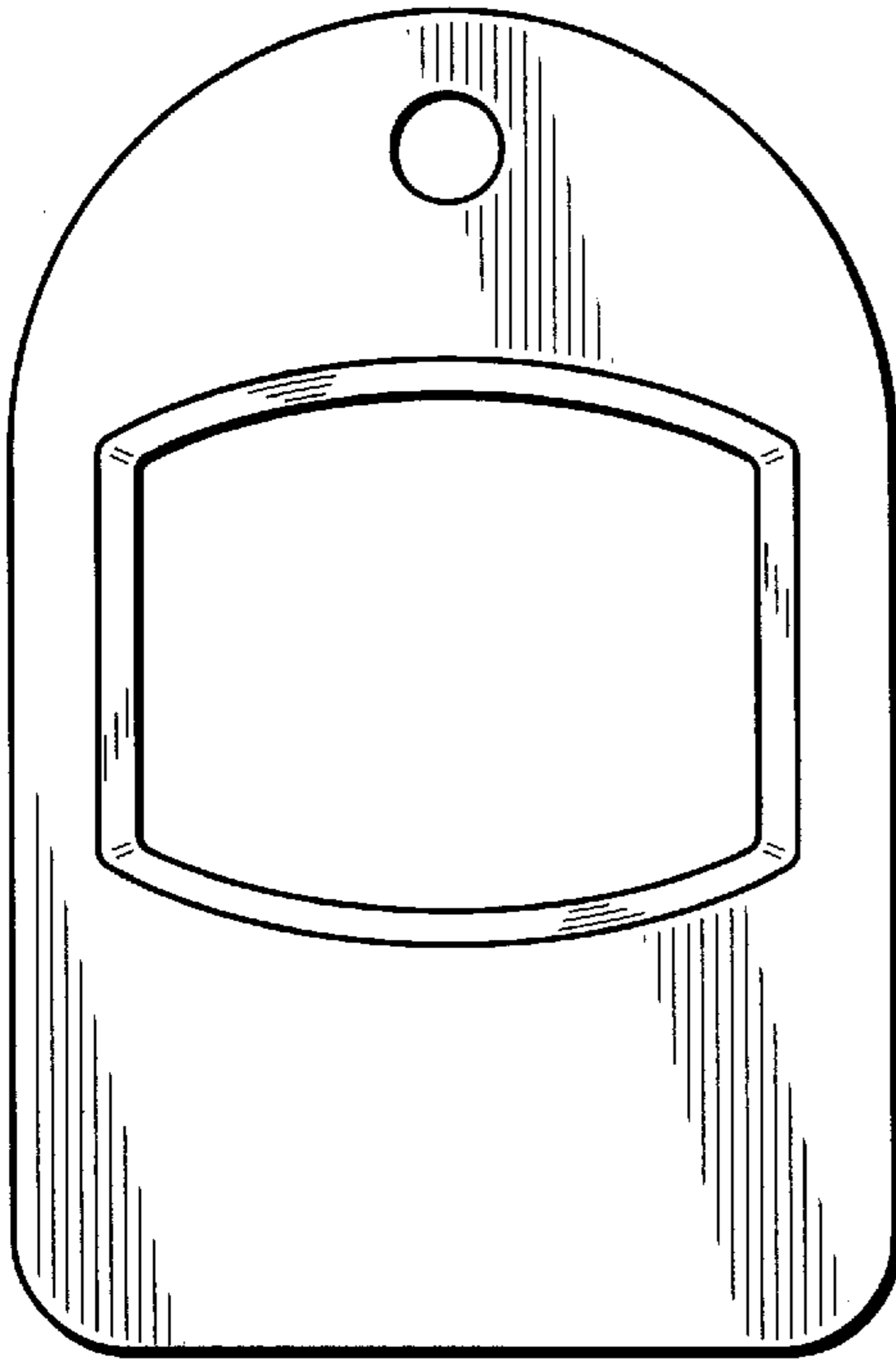
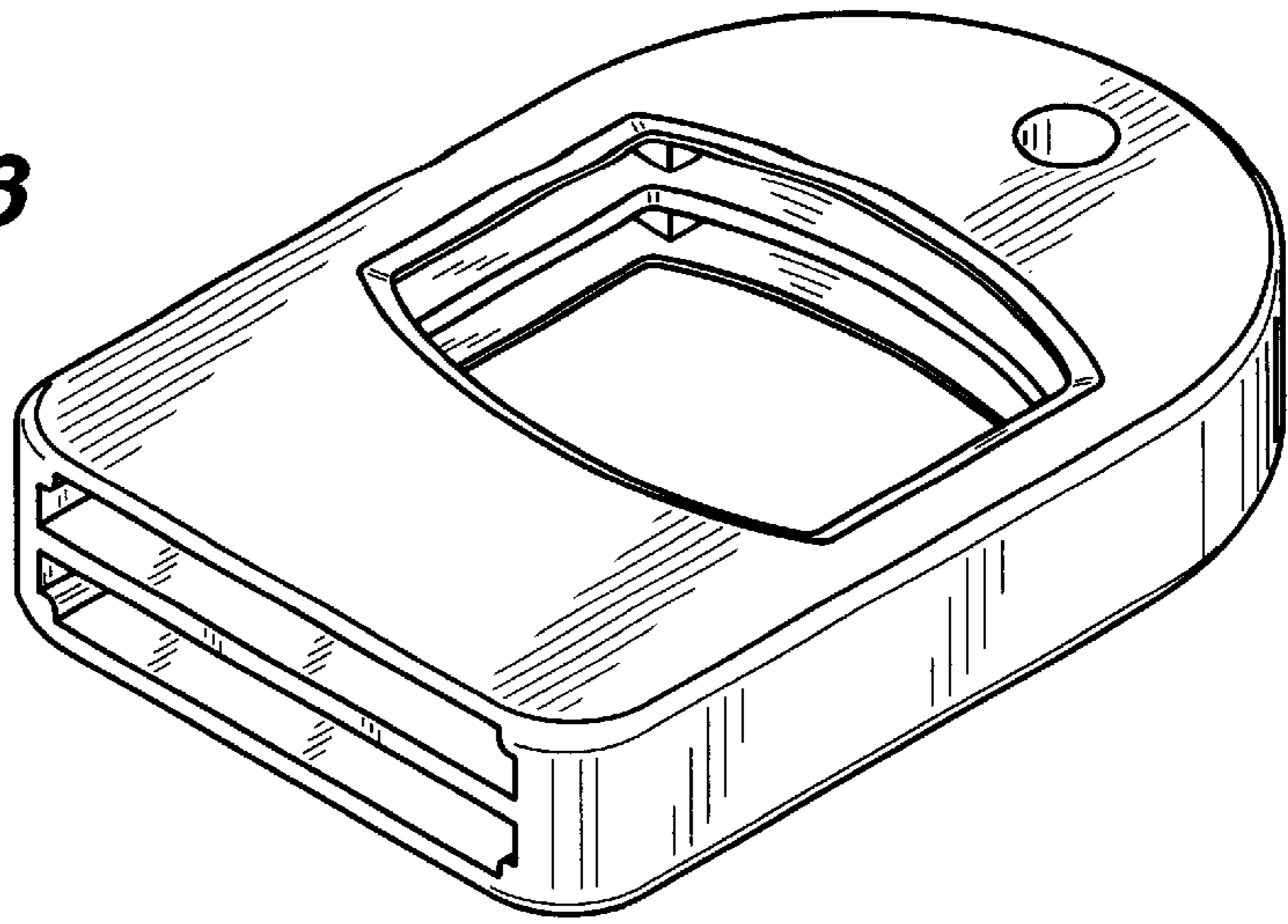

FIG._14

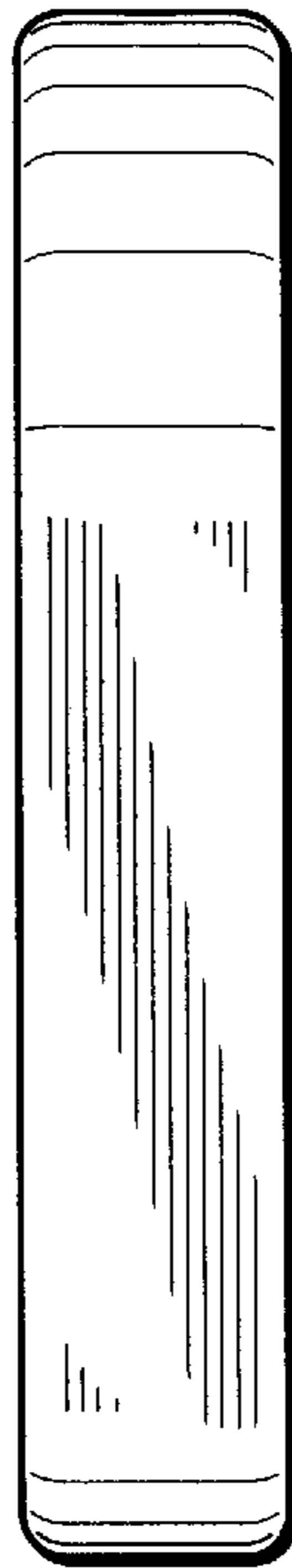

FIG._15

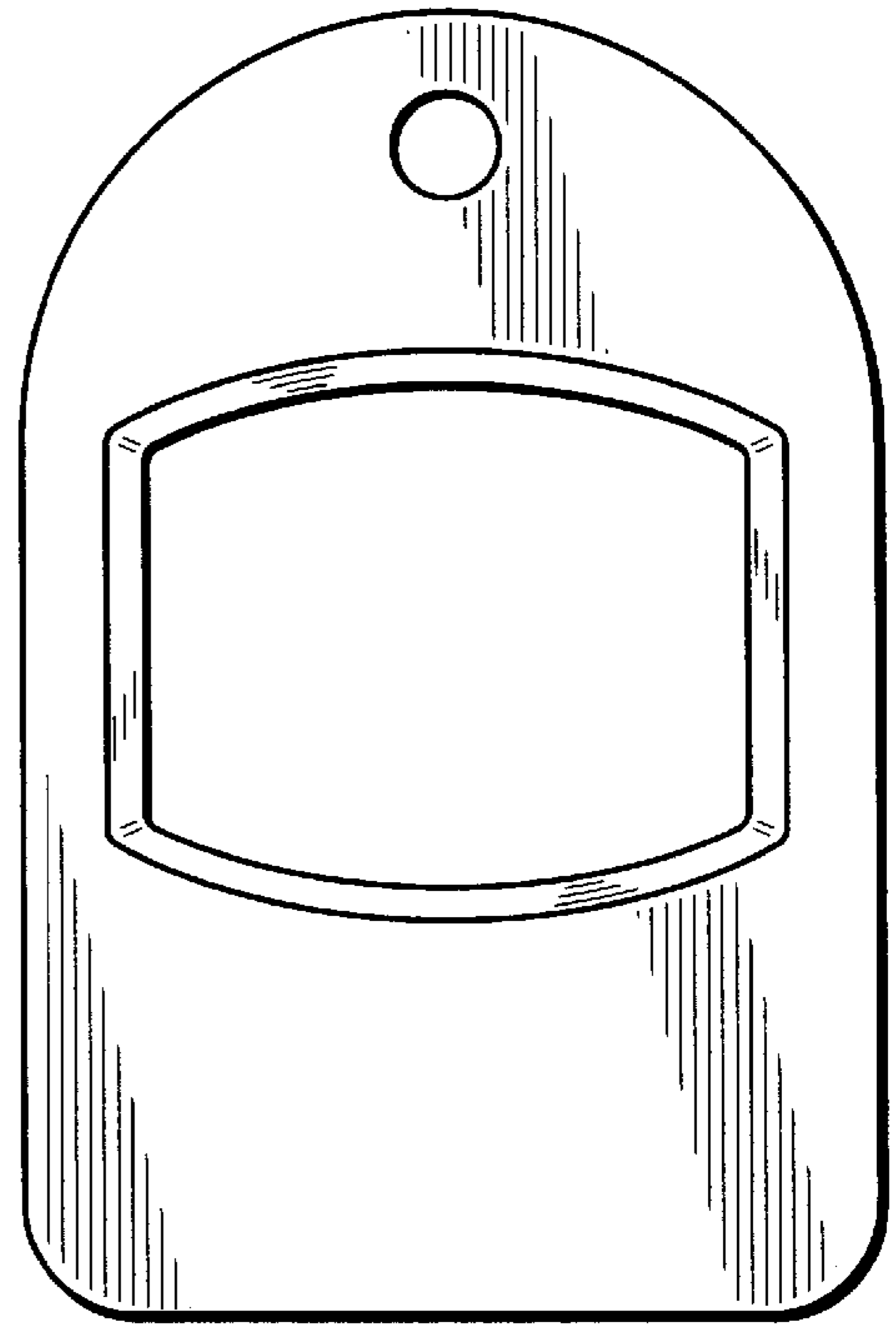

FIG._16

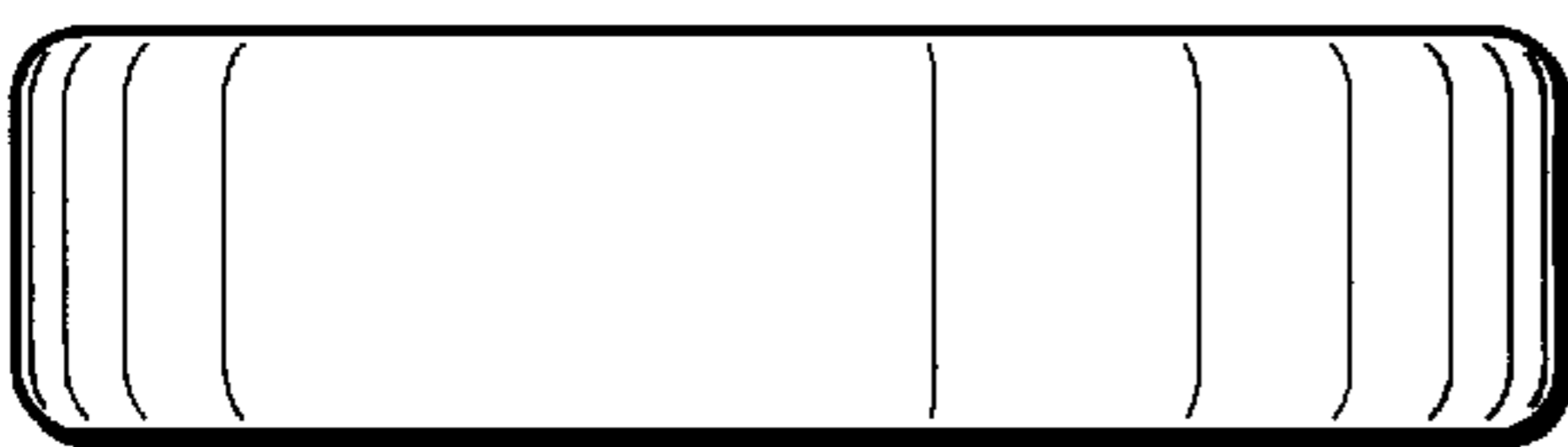

FIG._17

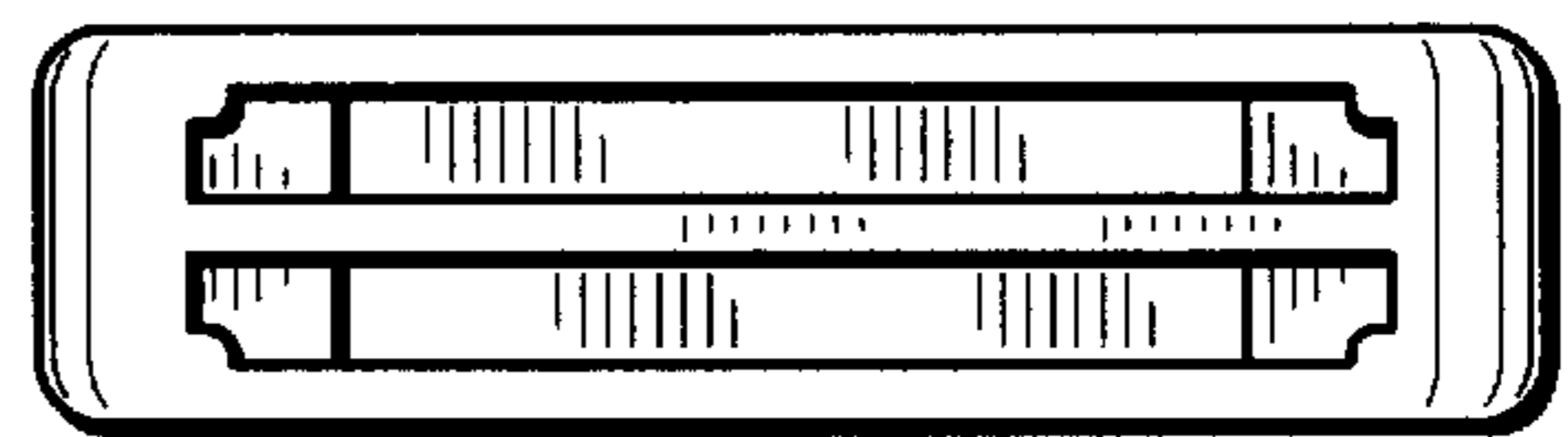

FIG._18