



US00D453493S

(12) **United States Design Patent**
Kokubu

(10) **Patent No.:** **US D453,493 S**

(45) **Date of Patent:** **** Feb. 12, 2002**

(54) **WHEEL FOR A TWO WHEELED MOTOR VEHICLE**

D406,091 S * 2/1999 Nishida D12/209
D419,515 S * 1/2000 Brown D12/209
D421,941 S * 3/2000 Cheng D12/209 X
D428,593 S * 7/2000 Julien D12/209

(75) Inventor: **Takahiro Kokubu, Wako (JP)**

* cited by examiner

(73) Assignee: **Honda Giken Kogyo Kabushiki Kaisha, Tokyo (JP)**

Primary Examiner—Stacia Cadmus

(**) Term: **14 Years**

(74) *Attorney, Agent, or Firm*—Arent Fox Kintner Plotkin & Kahn, PLLC

(21) Appl. No.: **29/138,078**

(57) **CLAIM**

(22) Filed: **Mar. 7, 2001**

The ornamental design for a wheel for a two-wheeled motor vehicle, as shown and described.

(30) **Foreign Application Priority Data**

Sep. 7, 2000 (JP) 12-024977

DESCRIPTION

(51) **LOC (7) Cl.** **12-16**

FIG. 1 is a front view of the wheel for a two-wheeled motor vehicle showing my new design.

(52) **U.S. Cl.** **D12/209**

FIG. 2 is a rear view thereof.

(58) **Field of Search** D12/204-211;
301/37.1, 64.1, 65

FIG. 3 is a right side view thereof.

FIG. 4 is a left side view thereof.

FIG. 5 is a plan view thereof.

FIG. 6 is a bottom view thereof.

FIG. 7 is a reference front view thereof.

FIG. 8 is a reference rear view thereof.

FIG. 9 is an end face view in a sectioned area taken along a line 9—9 in FIG. 7.

FIG. 10 is an end face view in a sectioned area taken along a line 10—10 in FIG. 7.

FIG. 11 is an end face view in a sectioned area taken along a line 11—11 in FIG. 7; and,

FIG. 12 is an end face view in a sectioned area taken along a line 12—12 in FIG. 8.

(56) **References Cited**

U.S. PATENT DOCUMENTS

D49,521 S	*	8/1916	Kunst	D12/209
D292,693 S	*	11/1987	Cattaneo	D12/211
D300,422 S	*	3/1989	Schinella	D12/209
D300,818 S	*	4/1989	Reid	D12/209
D364,844 S	*	12/1995	Chien	D12/209
D370,652 S	*	6/1996	Londry	D12/209
D372,697 S	*	8/1996	Echazabal et al.	D12/209
D378,506 S	*	3/1997	Stolz et al.	D12/209
D384,931 S	*	10/1997	Neeper	D12/209
D385,838 S	*	11/1997	Cullen	D12/209
D389,101 S	*	1/1998	Julien	D12/209 X
D398,273 S	*	9/1998	Suprihanto	D12/209

1 Claim, 6 Drawing Sheets

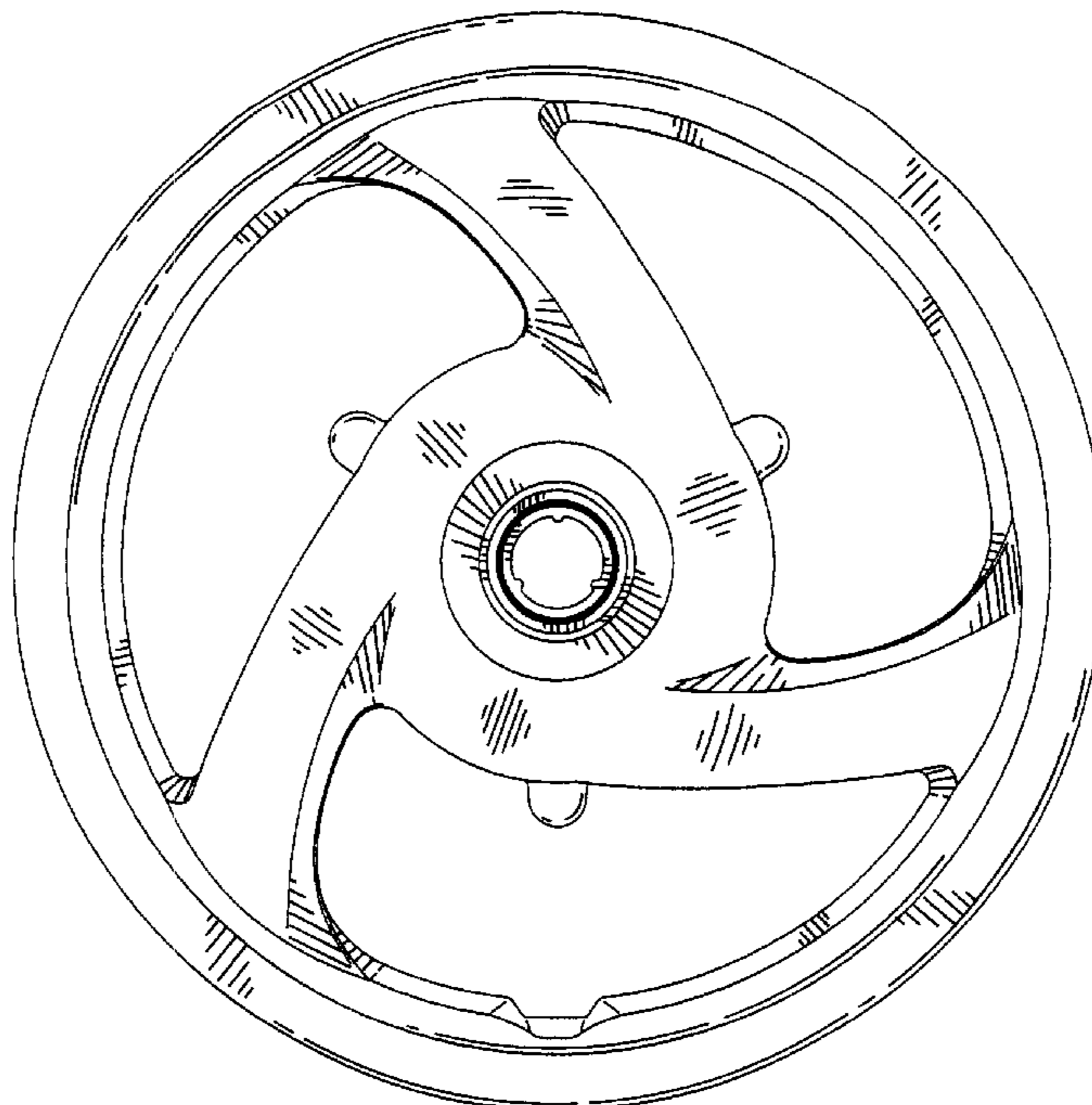

FIG. 1

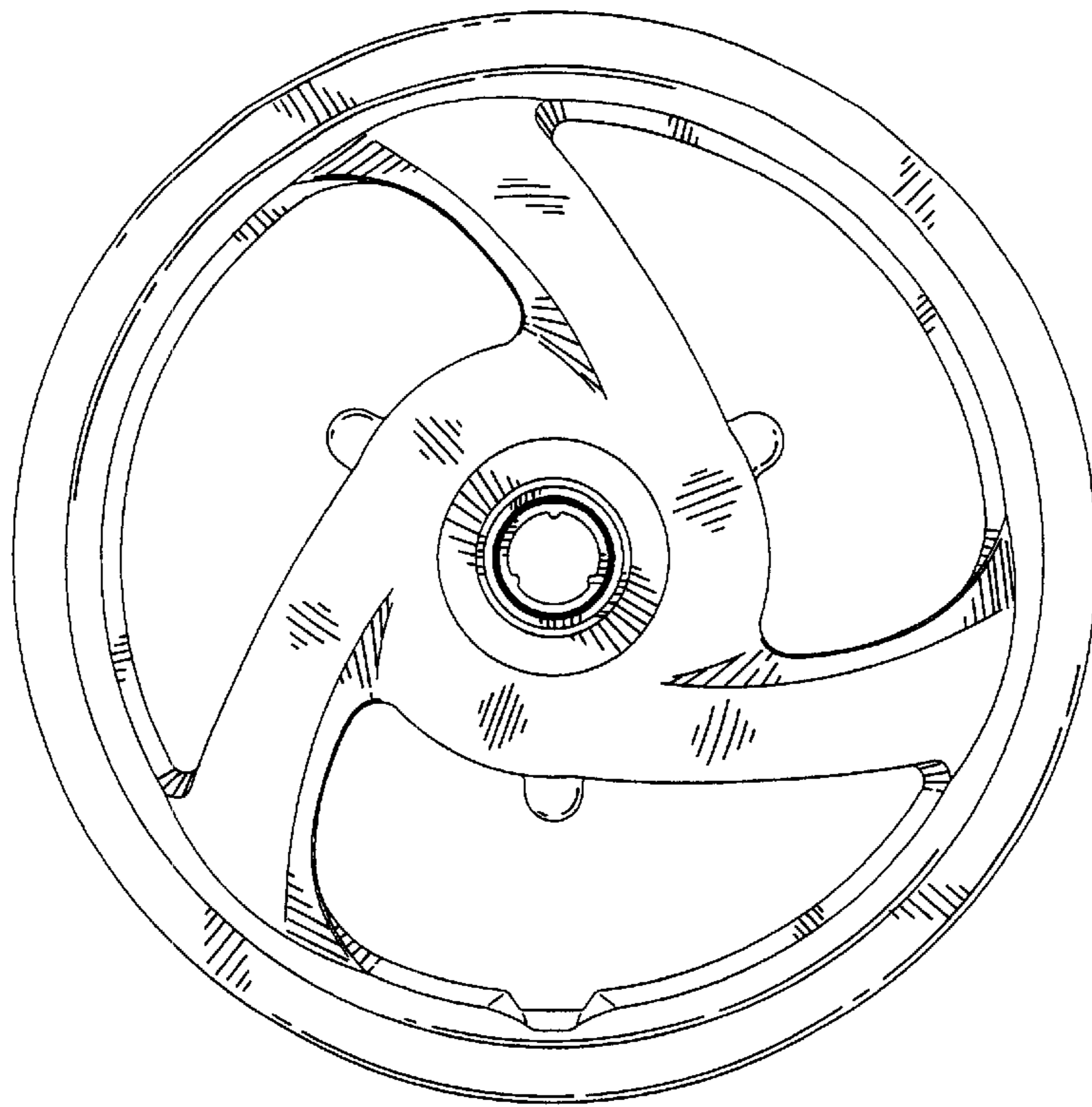

FIG. 2

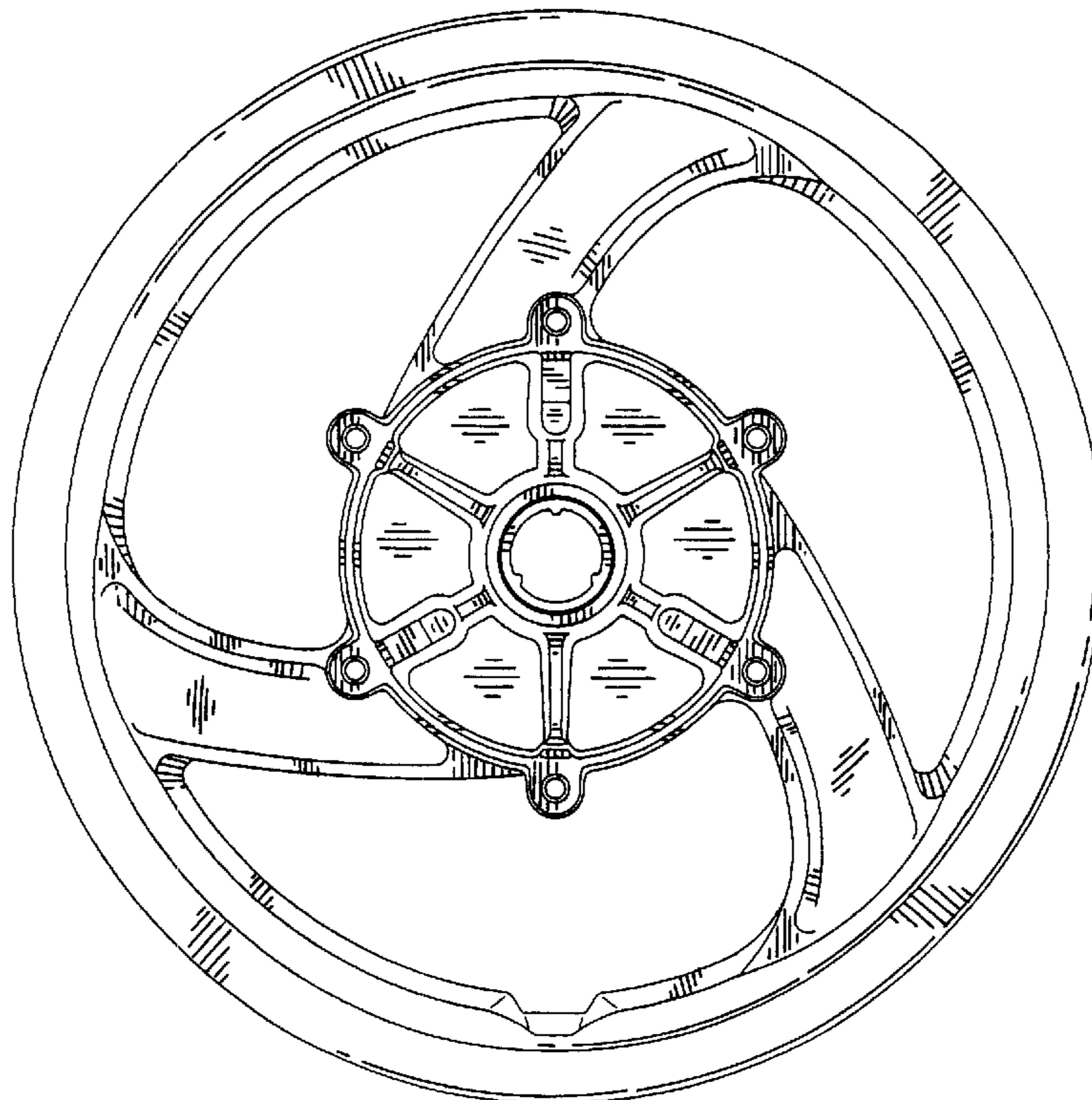

FIG. 3

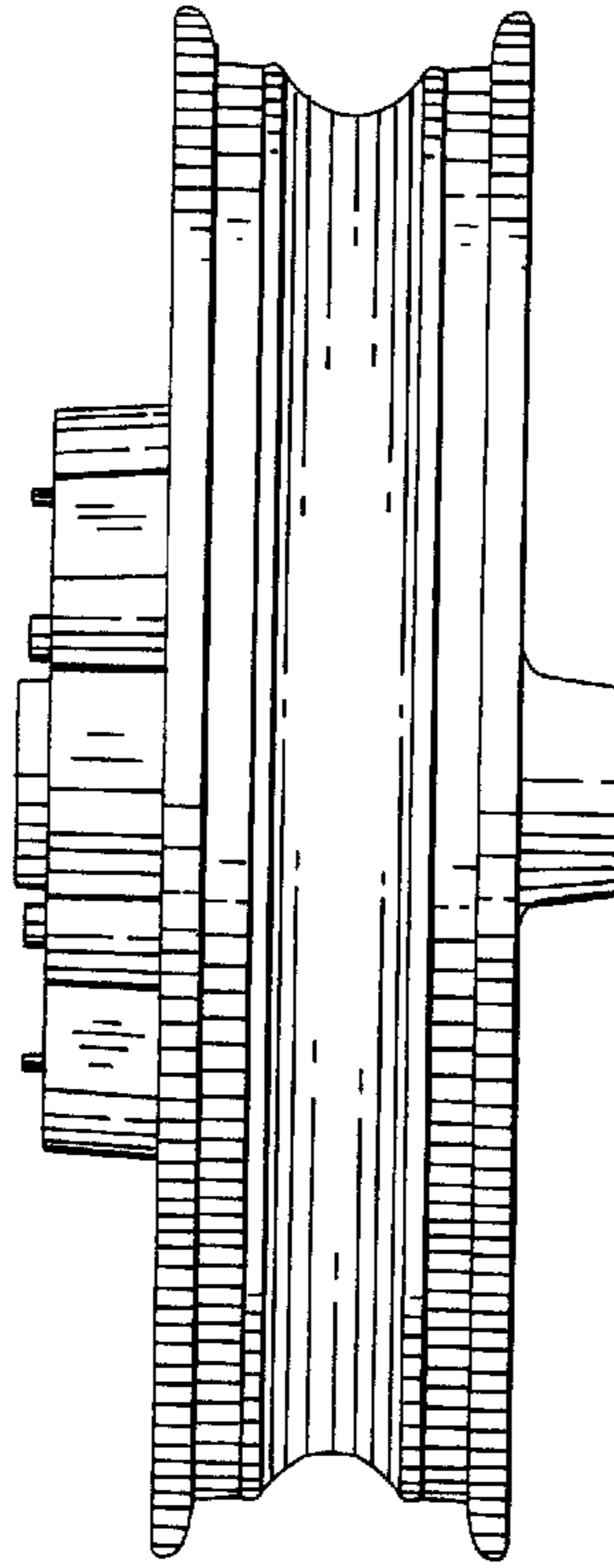

FIG. 4

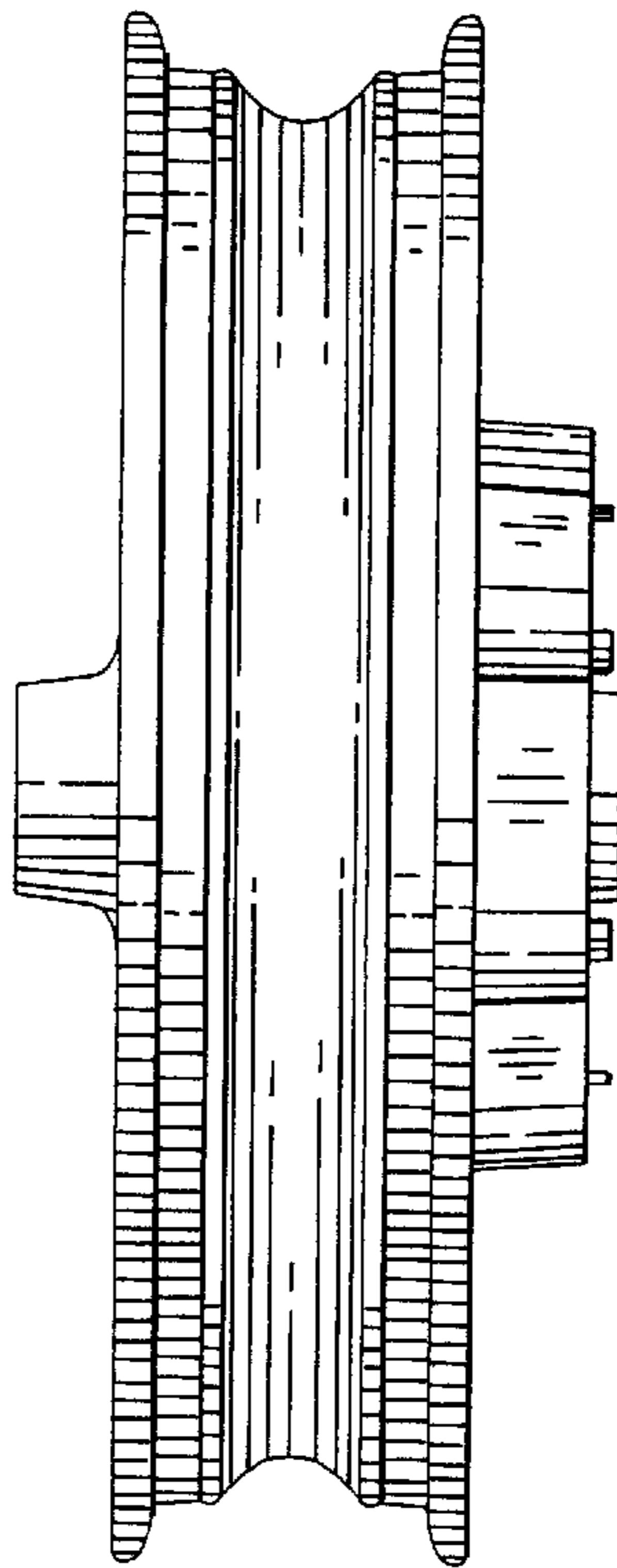

FIG. 5

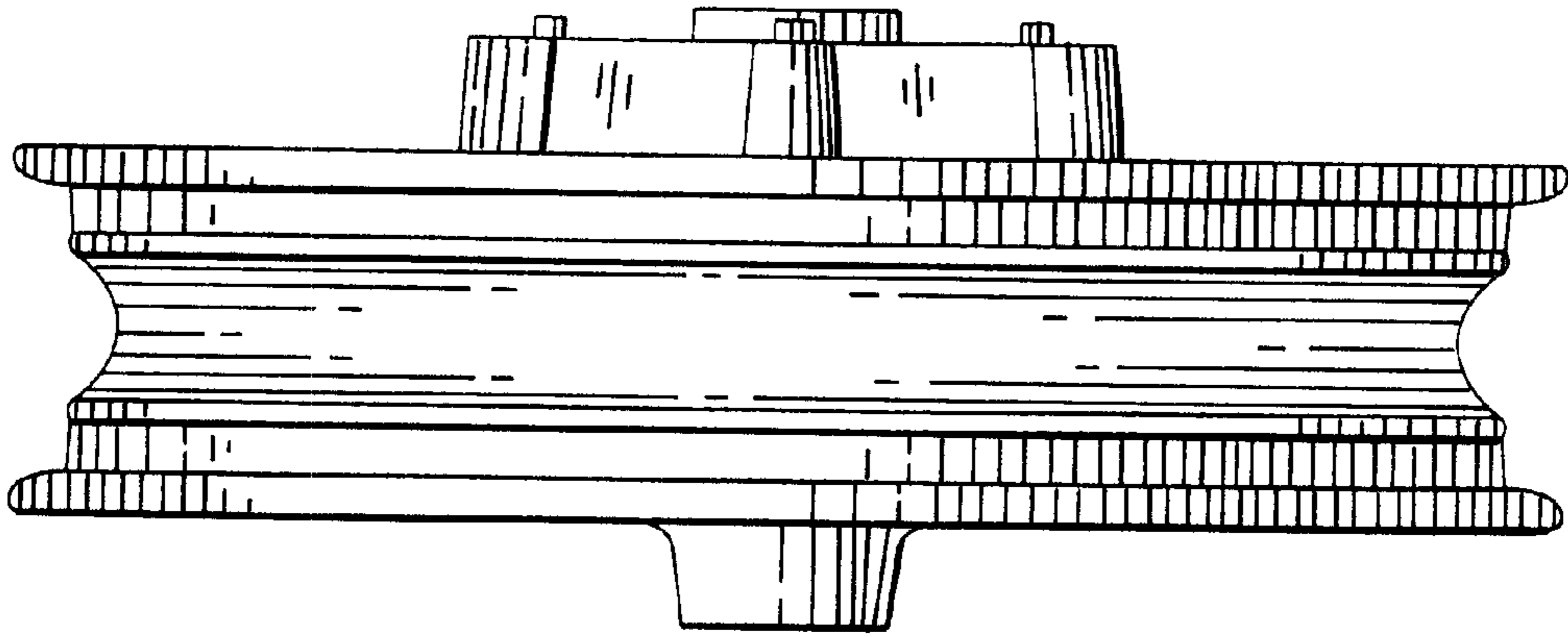

FIG. 6

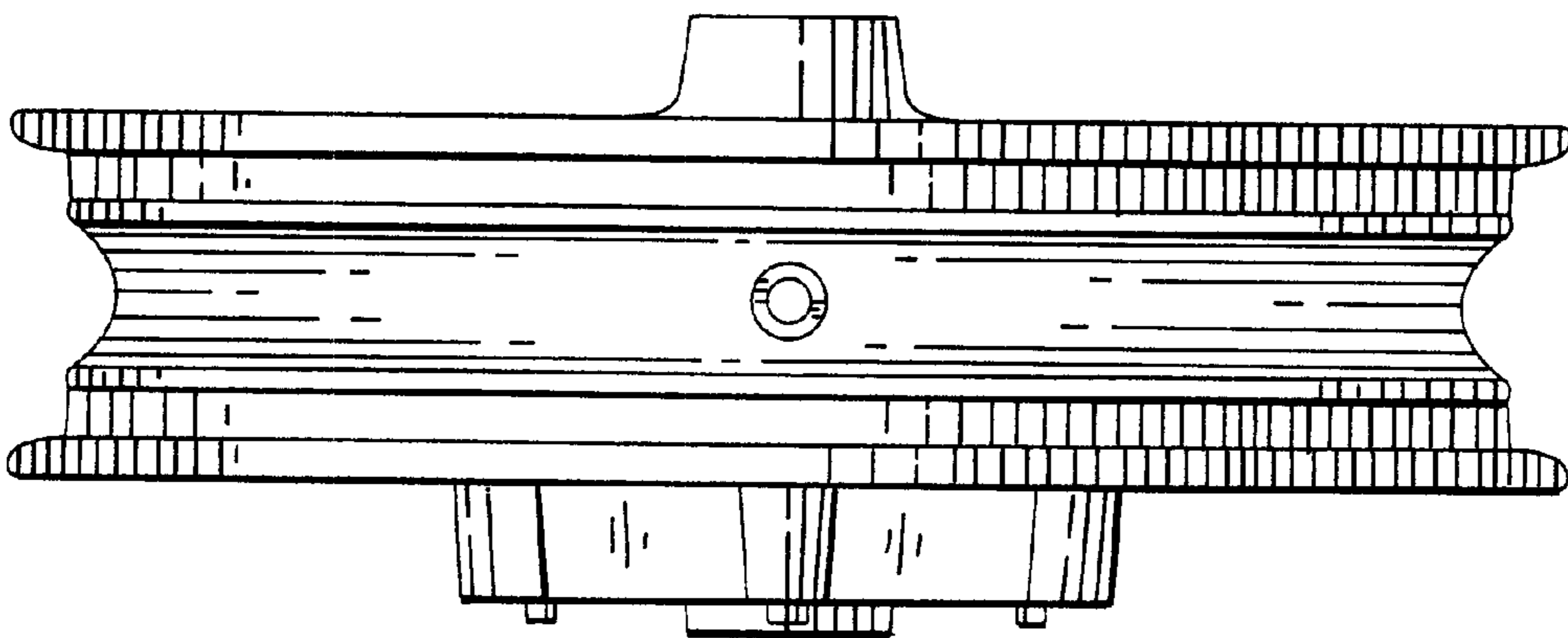

FIG. 7

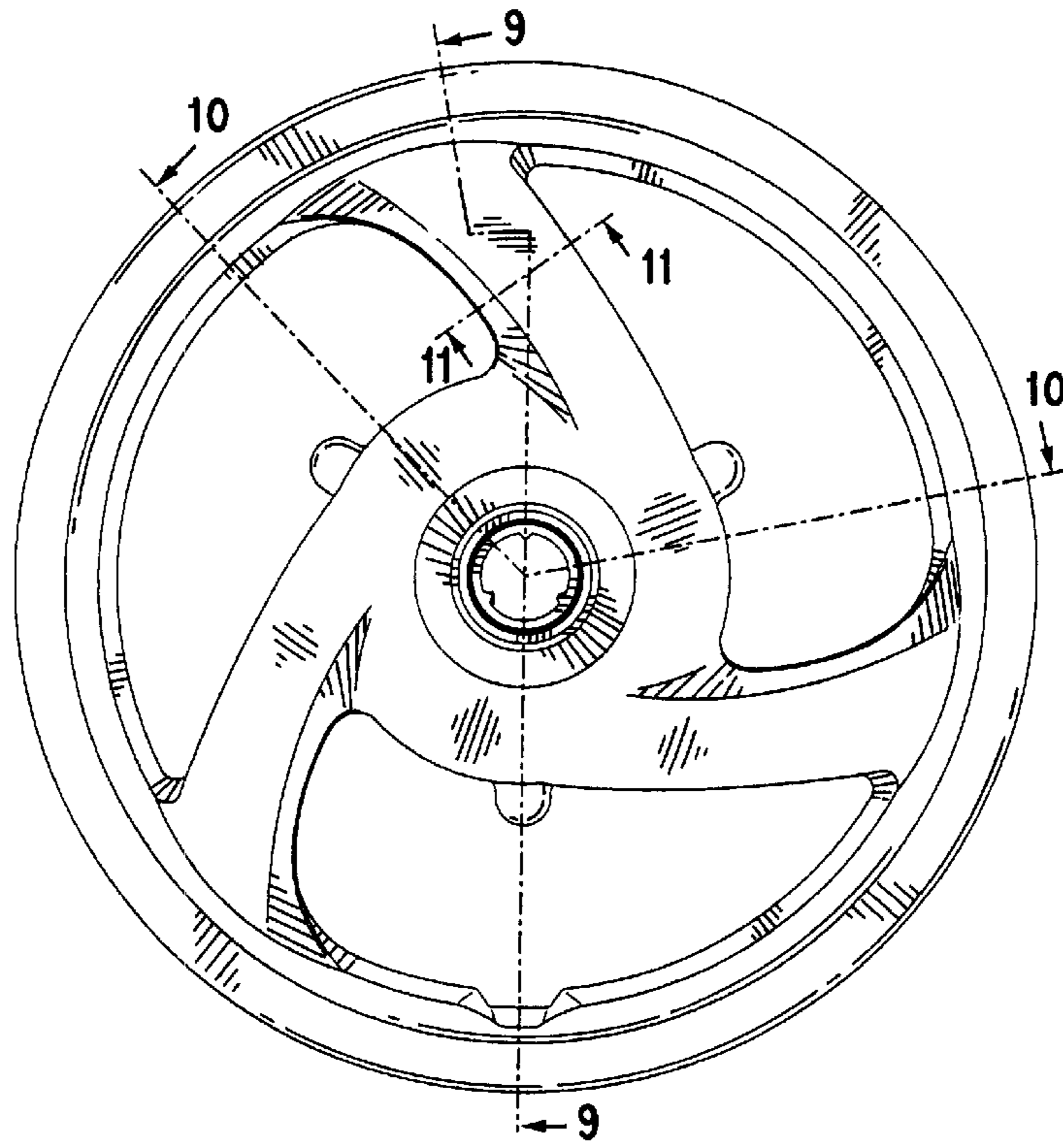
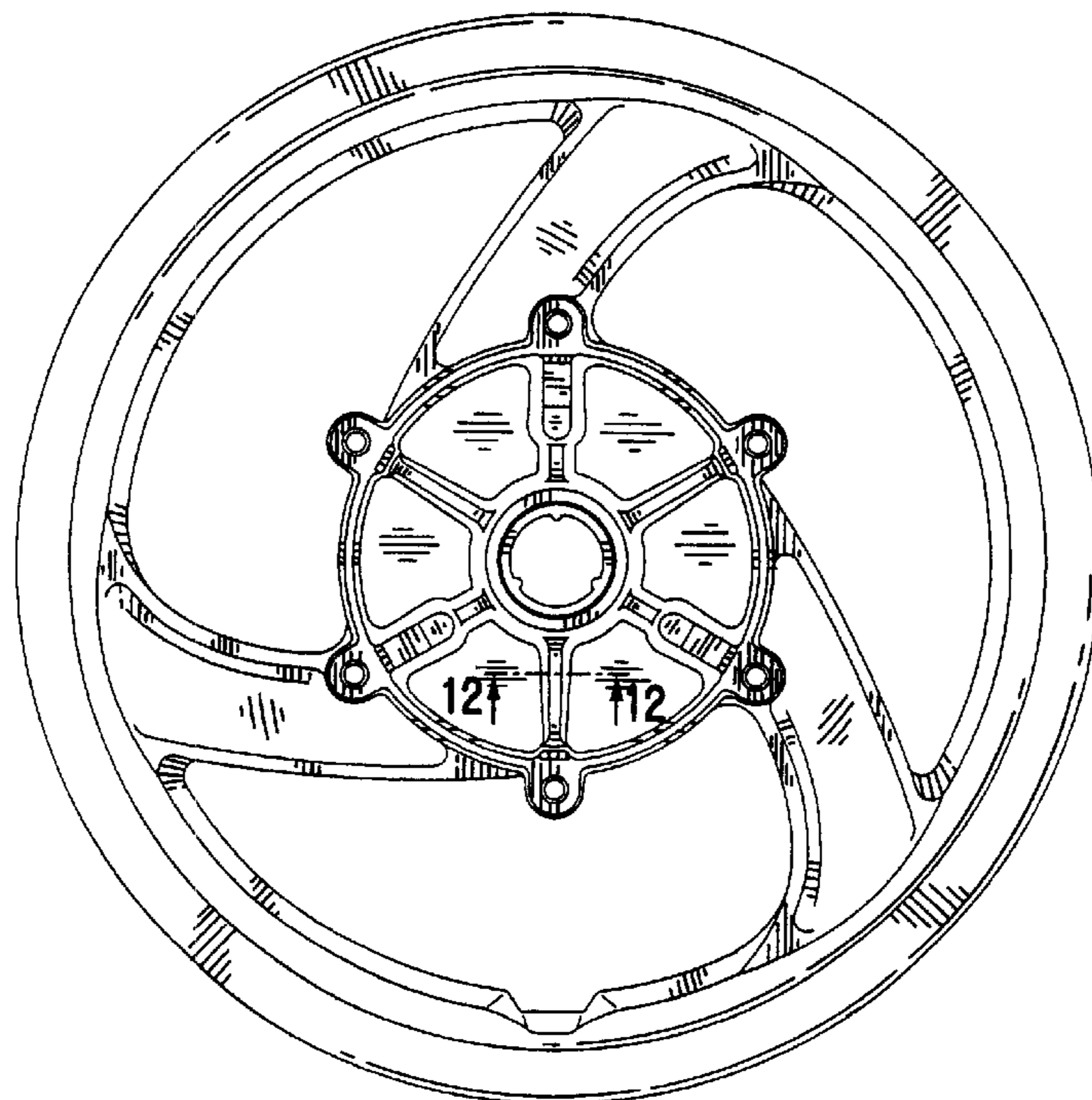

FIG. 8



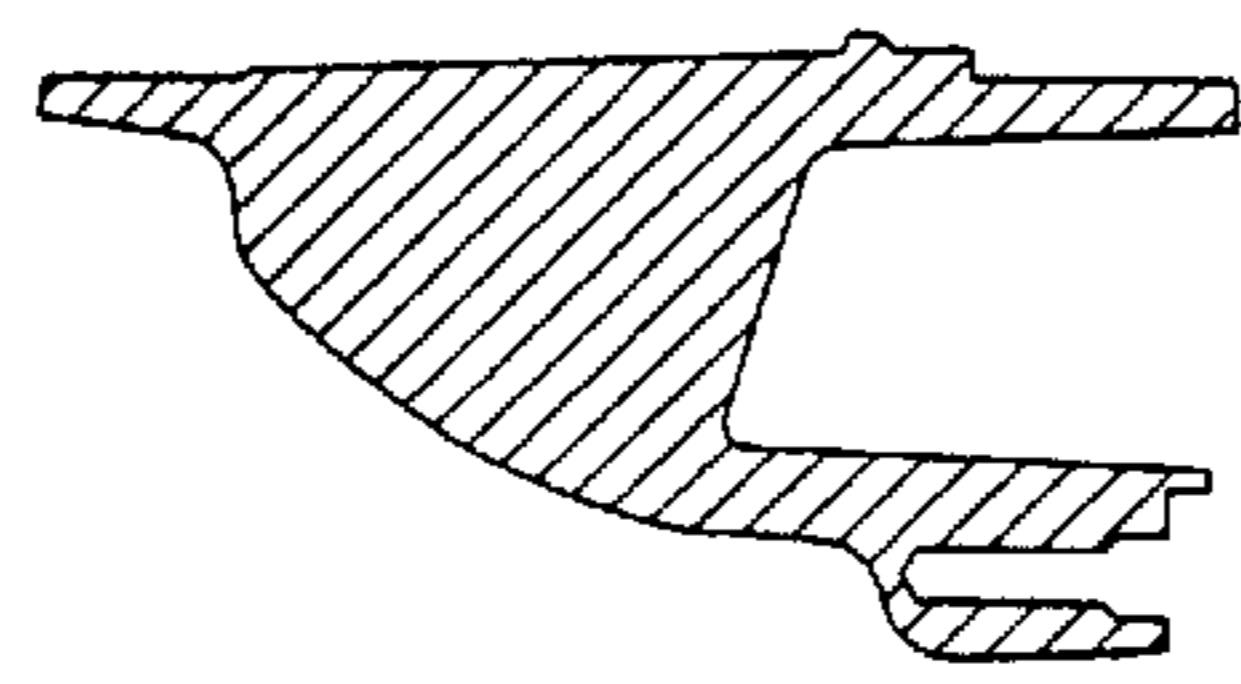
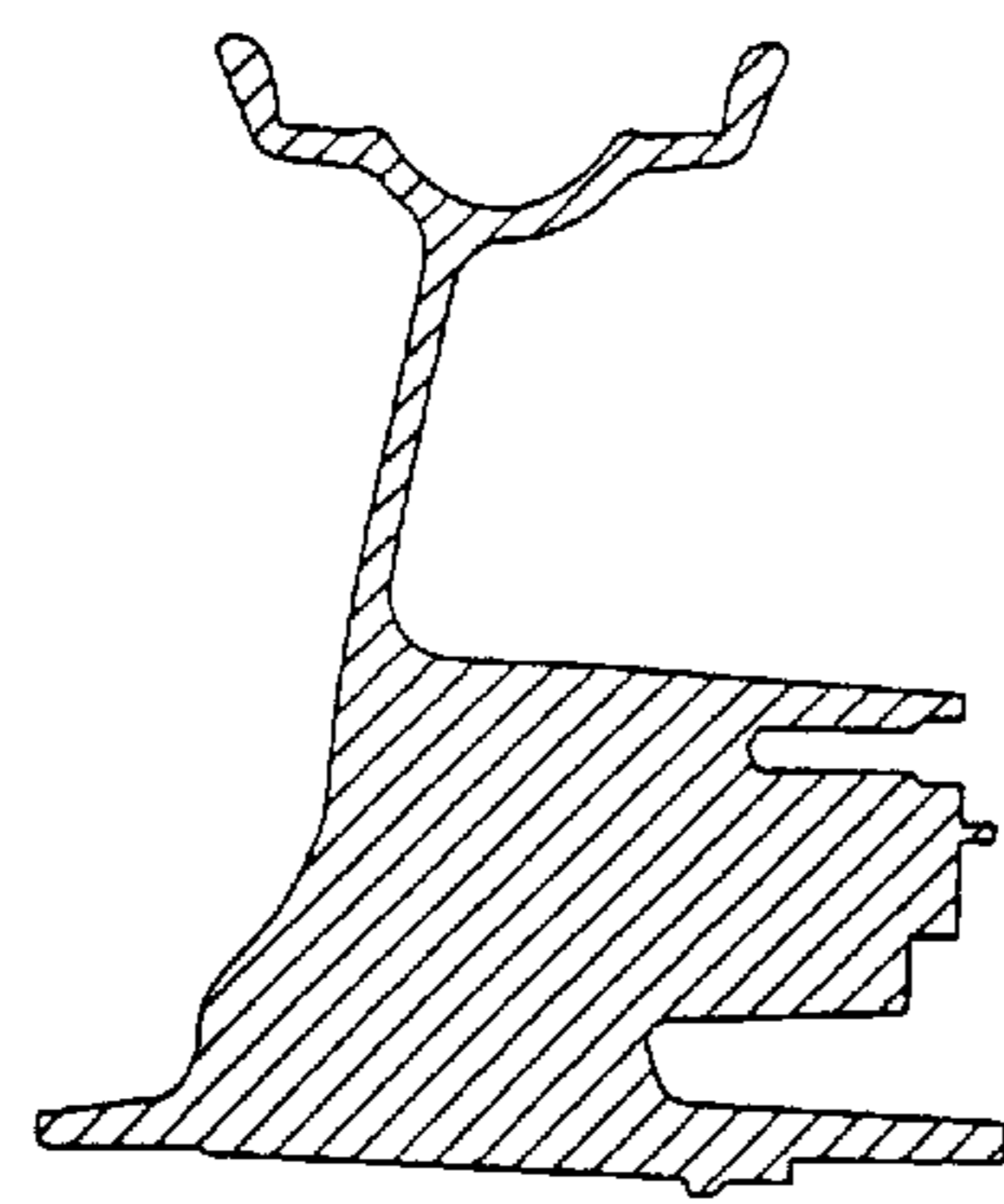

FIG. 9

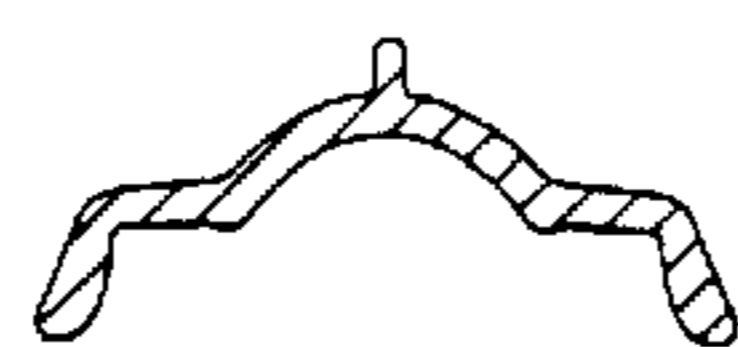
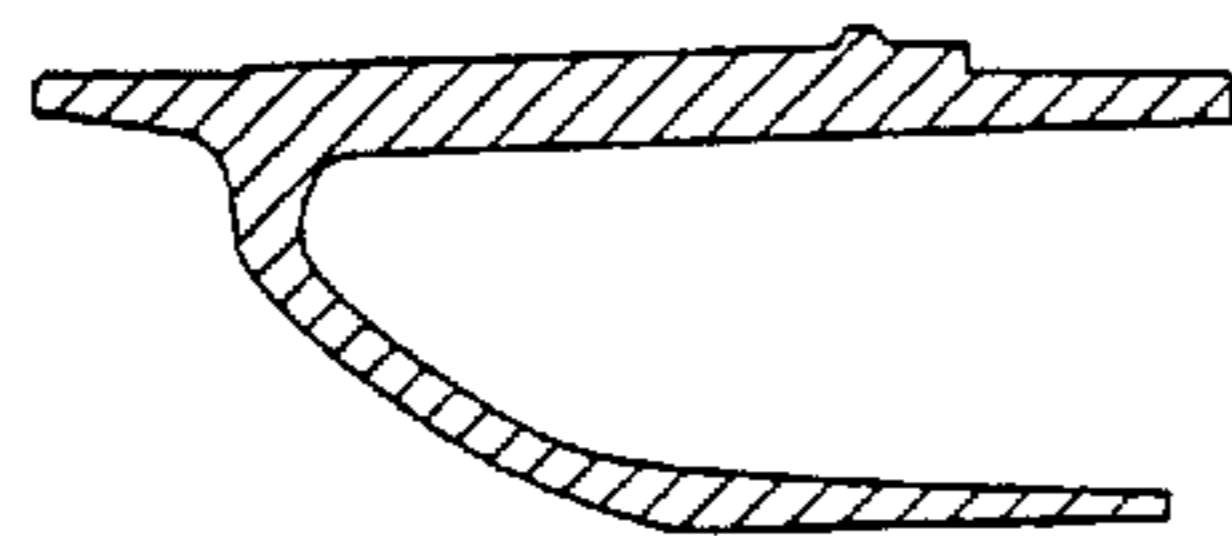
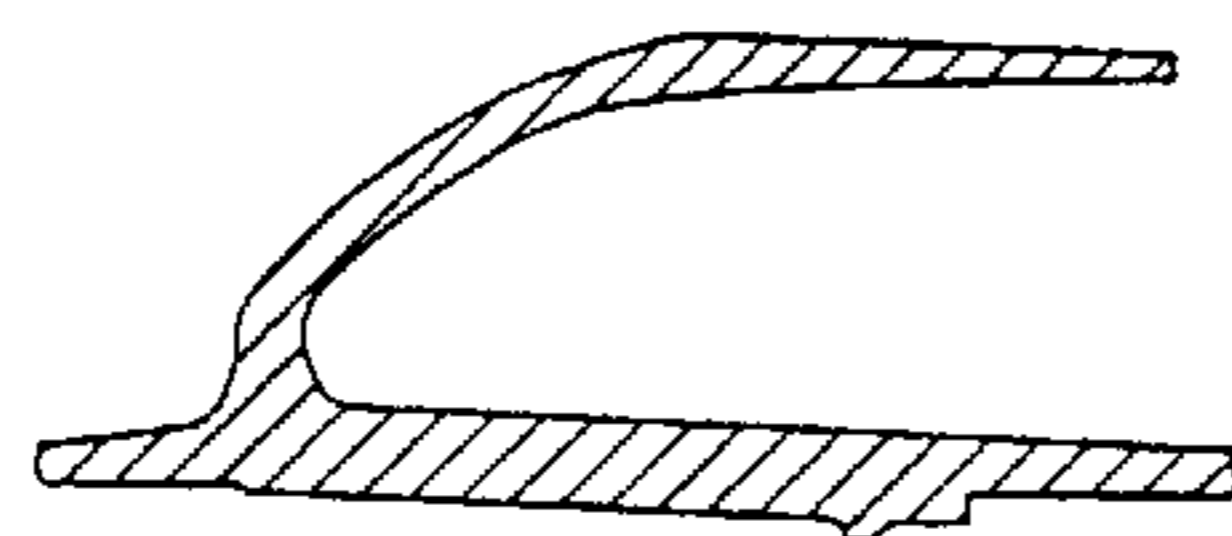
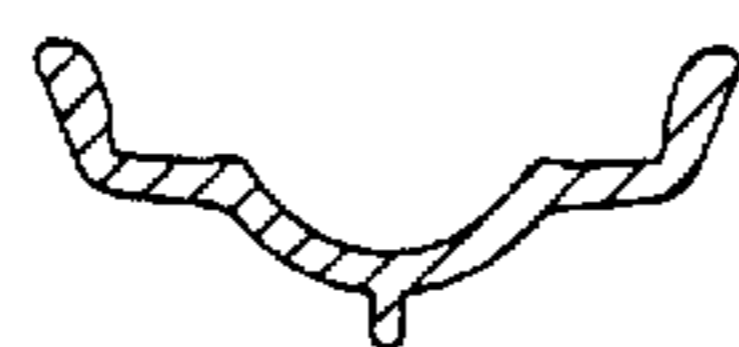

FIG. 10

FIG. 11

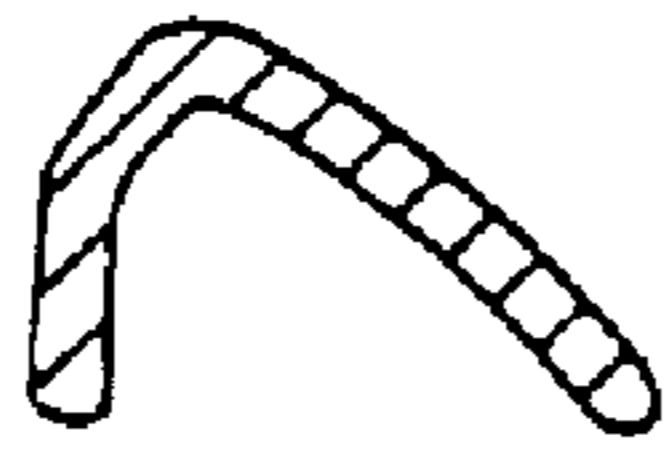

FIG. 12

