



US00D453386S

(12) **United States Design Patent**
Philipson

(10) **Patent No.:** **US D453,386 S**

(45) **Date of Patent:** **** Feb. 5, 2002**

(54) **DOG LEASH AND LIGHT COMBINATION**

(75) **Inventor:** **Andre R. Philipson**, deceased, late of New Orleans, LA (US), by Alan H. Philipson, succession

(73) **Assignee:** **Superior Merchandise Company Inc.**, New Orleans, LA (US)

(**) **Term:** **14 Years**

(21) **Appl. No.:** **29/137,093**

(22) **Filed:** **Feb. 14, 2001**

(51) **LOC (7) Cl.** **26-02**

(52) **U.S. Cl.** **D26/38**

(58) **Field of Search** D26/37-50; 362/253, 362/190, 191, 194, 198, 200, 201, 202; D30/151, 152; 119/792, 796, 789

(56) **References Cited**

U.S. PATENT DOCUMENTS

- 2,799,245 A * 7/1957 Ruggiero 119/792
- 5,429,075 A 7/1995 Passarella et al.
- 5,558,044 A 9/1996 Nasser, Jr. et al.

- 5,762,029 A 6/1998 DuBois et al.
- 5,887,550 A 3/1999 Levine et al.
- 5,983,836 A 11/1999 Chavez
- 6,003,472 A 12/1999 Matt et al.
- 6,024,054 A 2/2000 Matt et al.
- 6,148,773 A * 11/2000 Bogdahn 119/796

* cited by examiner

Primary Examiner—Susan J. Lucas

(74) *Attorney, Agent, or Firm*—Nixon & Vanderhye P.C.

(57) **CLAIM**

The ornamental design for a “dog leash and light combination”, as shown and described.

DESCRIPTION

FIG. 1 is a perspective view of the dog leash/light according to the present invention;
 FIG. 2 is a left-side view thereof;
 FIG. 3 is a right-side view thereof;
 FIG. 4 is a front view thereof;
 FIG. 5 is a rear view thereof;
 FIG. 6 is a top view thereof; and,
 FIG. 7 is a bottom view thereof.

1 Claim, 5 Drawing Sheets

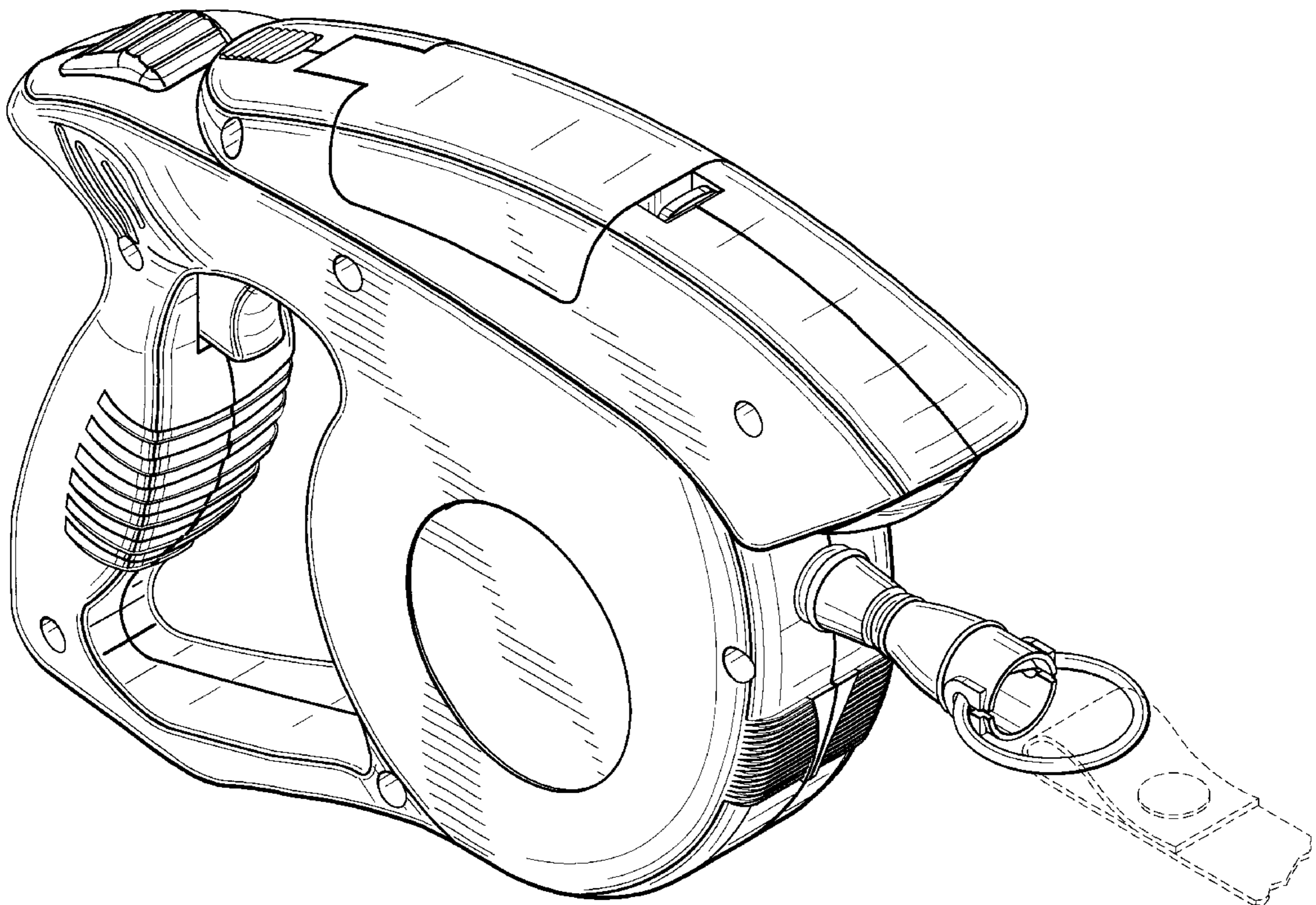

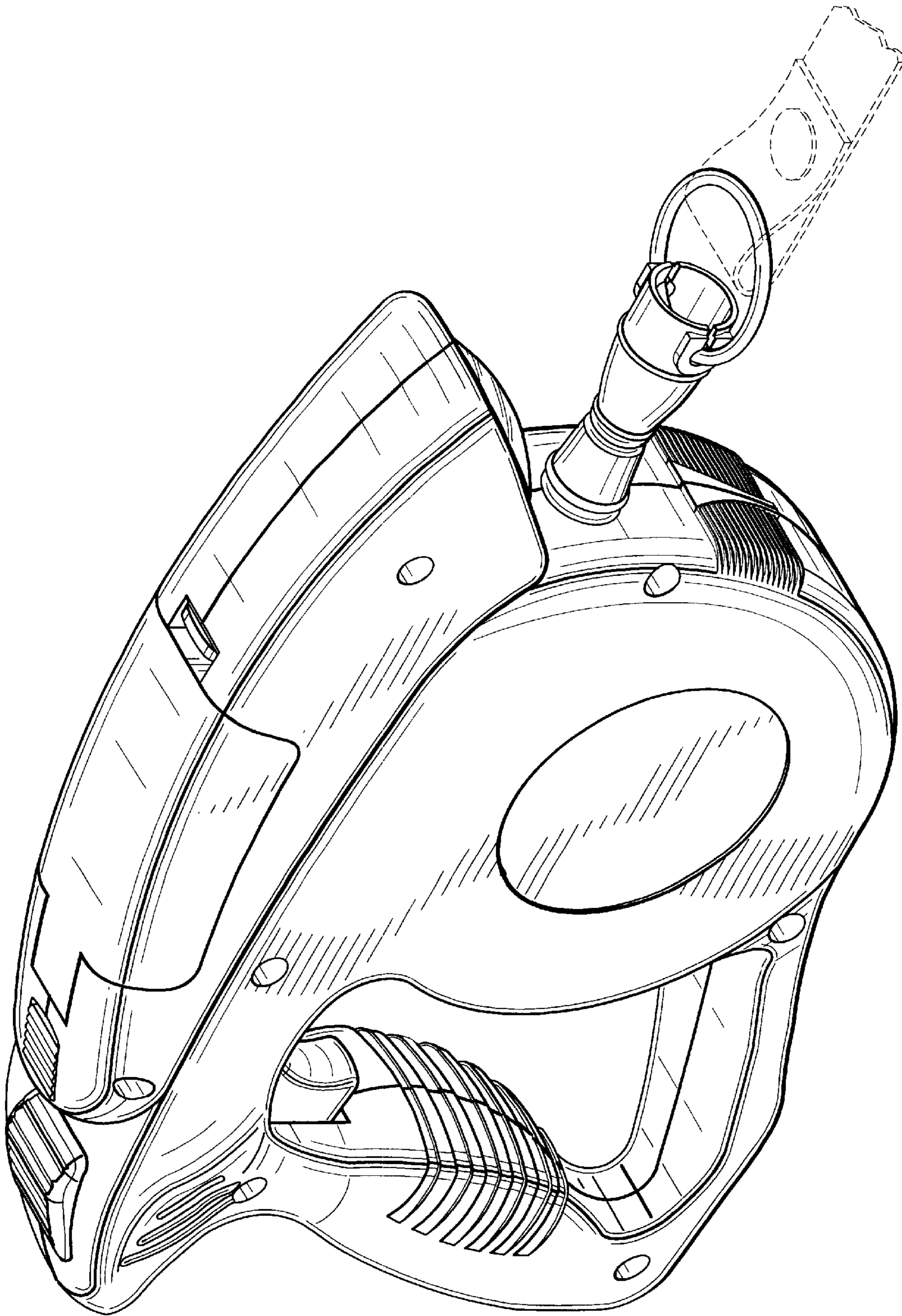

Fig.1

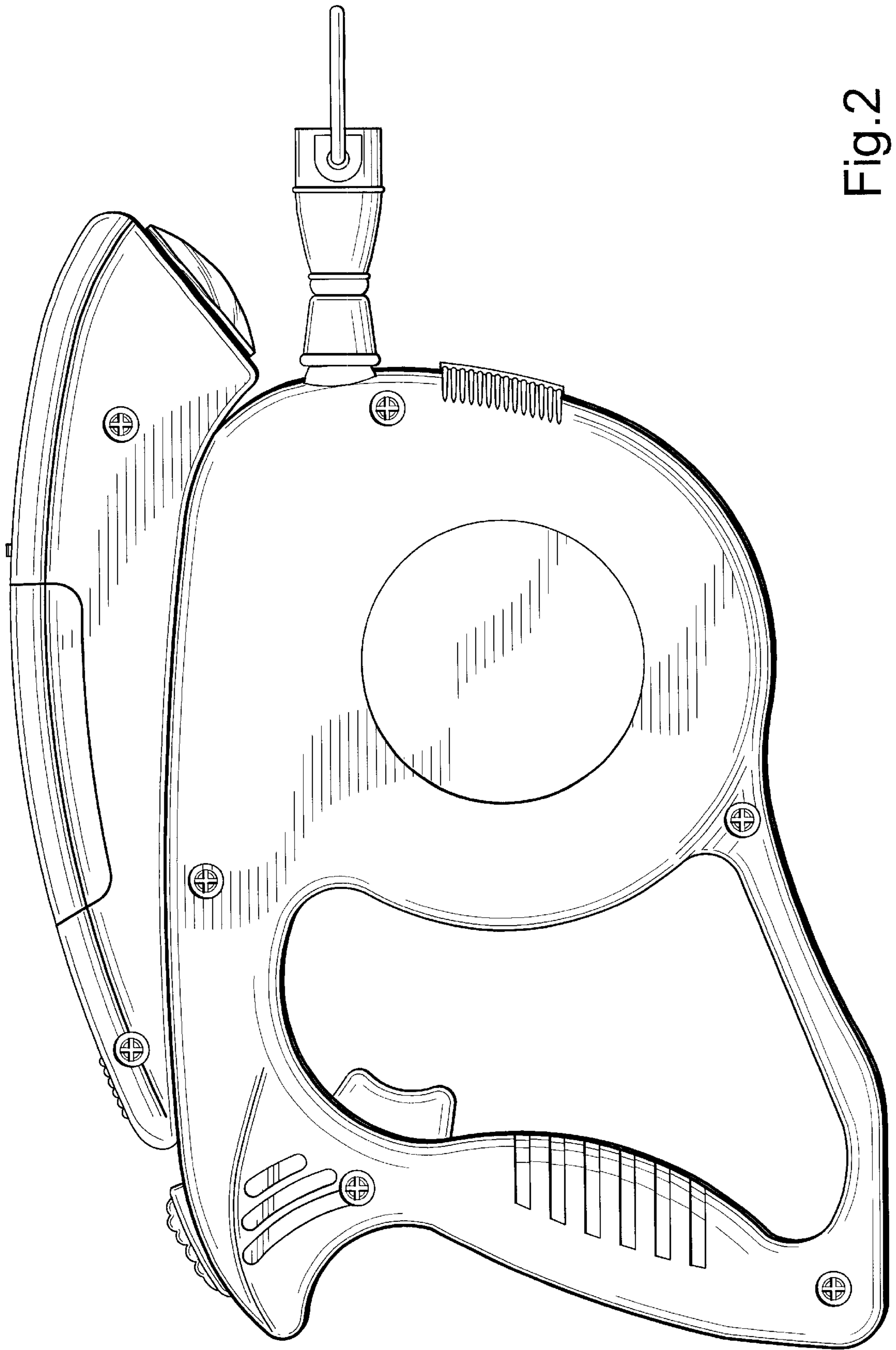

Fig. 2

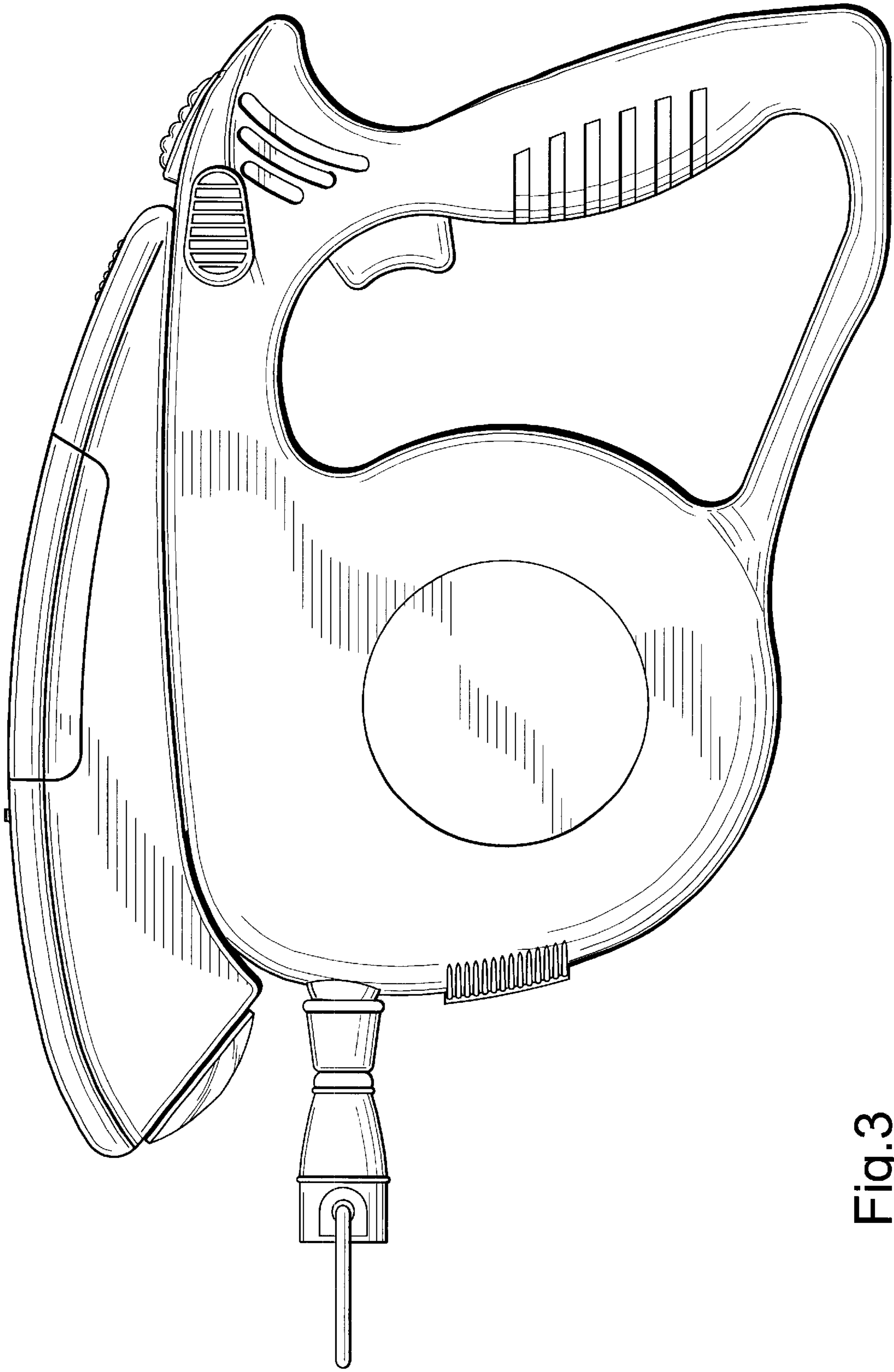

Fig.3

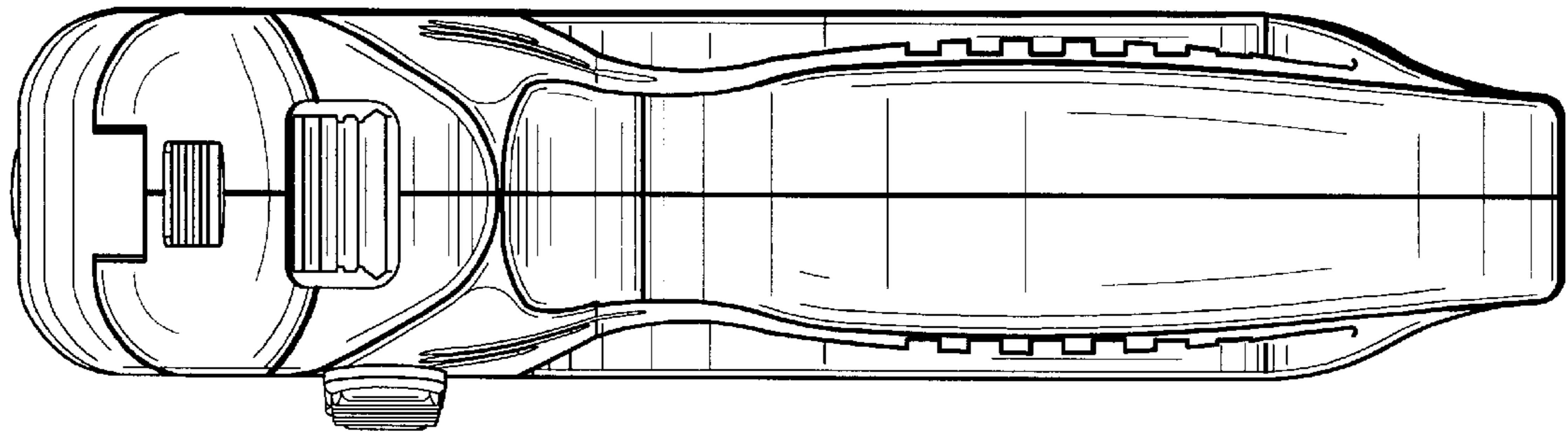

Fig.5

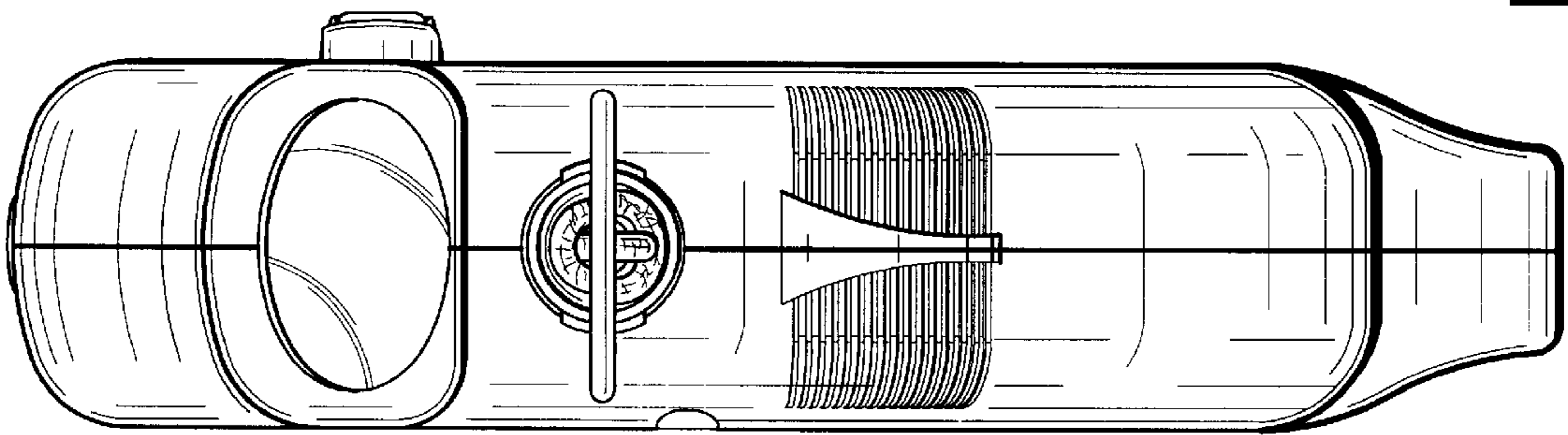

Fig.4

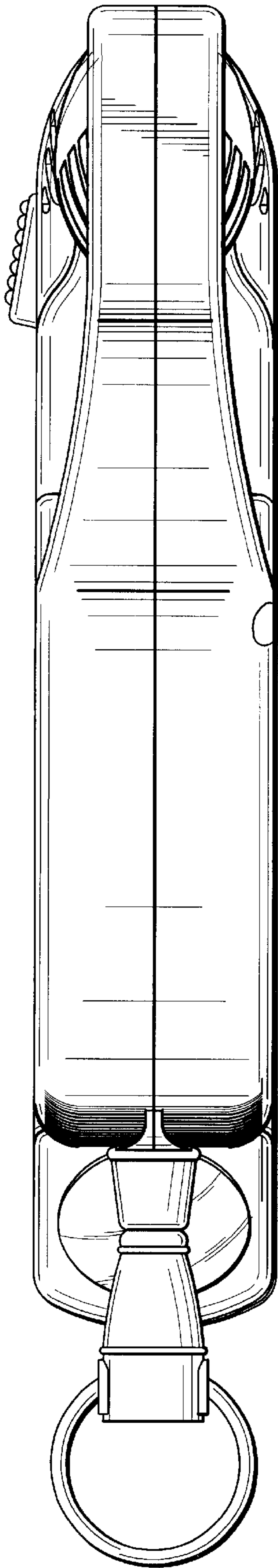

Fig.6

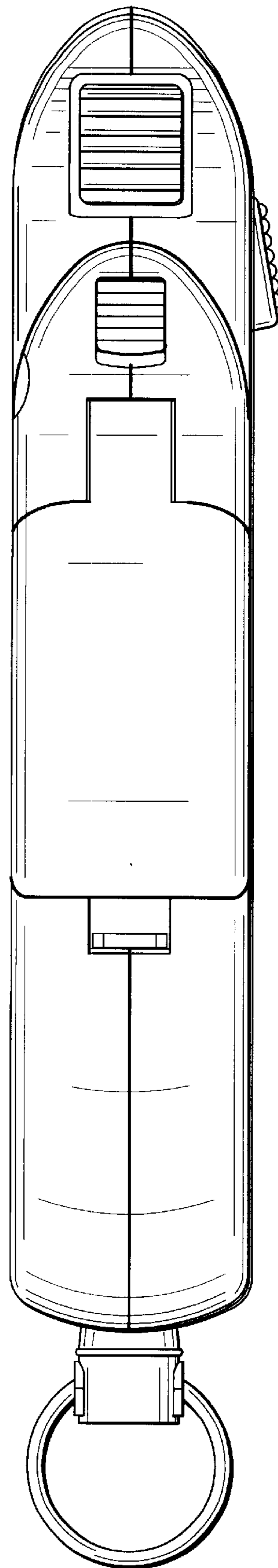

Fig.7

UNITED STATES PATENT AND TRADEMARK OFFICE
CERTIFICATE OF CORRECTION

PATENT NO. : Des 453,386 S
DATED : February 5, 2002
INVENTOR(S) : Philipson et al.

Page 1 of 1

It is certified that error appears in the above-identified patent and that said Letters Patent is hereby corrected as shown below:

Title page,

Delete "[75] Inventor: **Andre R. Philipson**, deceased, late of New Orleans, LA (US), by **Alan H. Philipson**, succession" and insert

-- [75] Inventors: **Alan H. Philipson**, New Orleans, LA (US); **Andre R. Philipson**, deceased, late of New Orleans, LA (US), by **Moise S. Steeg, Jr.**, succession --

Signed and Sealed this

Sixth Day of August, 2002

Attest:



Attesting Officer

JAMES E. ROGAN
Director of the United States Patent and Trademark Office