



US00D453366S

(12) **United States Design Patent**  
**French**

(10) **Patent No.:** **US D453,366 S**

(45) **Date of Patent:** **\*\* Feb. 5, 2002**

(54) **STRAP FOR HOLDING A PAIR OF SKIS TOGETHER**

*Primary Examiner*—Kay H. Chin  
(74) *Attorney, Agent, or Firm*—Salter & Michaelson

(76) **Inventor:** **Michael French**, P.O. Box 369, 860 W. Central St., Franklin, MA (US) 02038

(57) **CLAIM**

The ornamental design for a strap for holding a pair of skis together, as shown and described.

(\*\*) **Term:** **14 Years**

**DESCRIPTION**

(21) **Appl. No.:** **29/138,308**

FIG. 1 is a perspective view of a strap for holding a pair of skis together showing my new design;  
FIG. 2 is a top plan view thereof;  
FIG. 3 is a bottom plan view thereof;  
FIG. 4 is a right edge view thereof;  
FIG. 5 is a left edge view thereof;  
FIG. 6 is a left end view thereof;  
FIG. 7 is a right end view thereof;  
FIG. 8 is a perspective view showing the strap in folded operative position;  
FIG. 9 is a perspective view showing the strap partially wound around a pair of skis; and,  
FIG. 10 is a perspective view showing the strap completely wound around a pair of skis.

(22) **Filed:** **Mar. 9, 2001**

(51) **LOC (7) Cl.** ..... **21-02**

(52) **U.S. Cl.** ..... **D21/774**

(58) **Field of Search** ..... D21/771, 774;  
280/814; 294/146, 147, 149, 150, 152,  
157; 224/250, 257, 258

The parts shown in broken lines in FIGS. 9 and 10 are for information only, and form no part of the instant design.

(56) **References Cited**

**U.S. PATENT DOCUMENTS**

3,841,648	A	*	10/1974	Meyer	.....	280/814
5,056,820	A	*	10/1991	Des Prez	.....	280/814
5,197,760	A	*	3/1993	Schollenberger	.....	280/814
5,318,209	A	*	6/1994	Rader et al.	.....	224/250
5,427,291	A	*	6/1995	Smith	.....	224/250
5,460,308	A	*	10/1995	Hahn	.....	224/257

\* cited by examiner

**1 Claim, 6 Drawing Sheets**

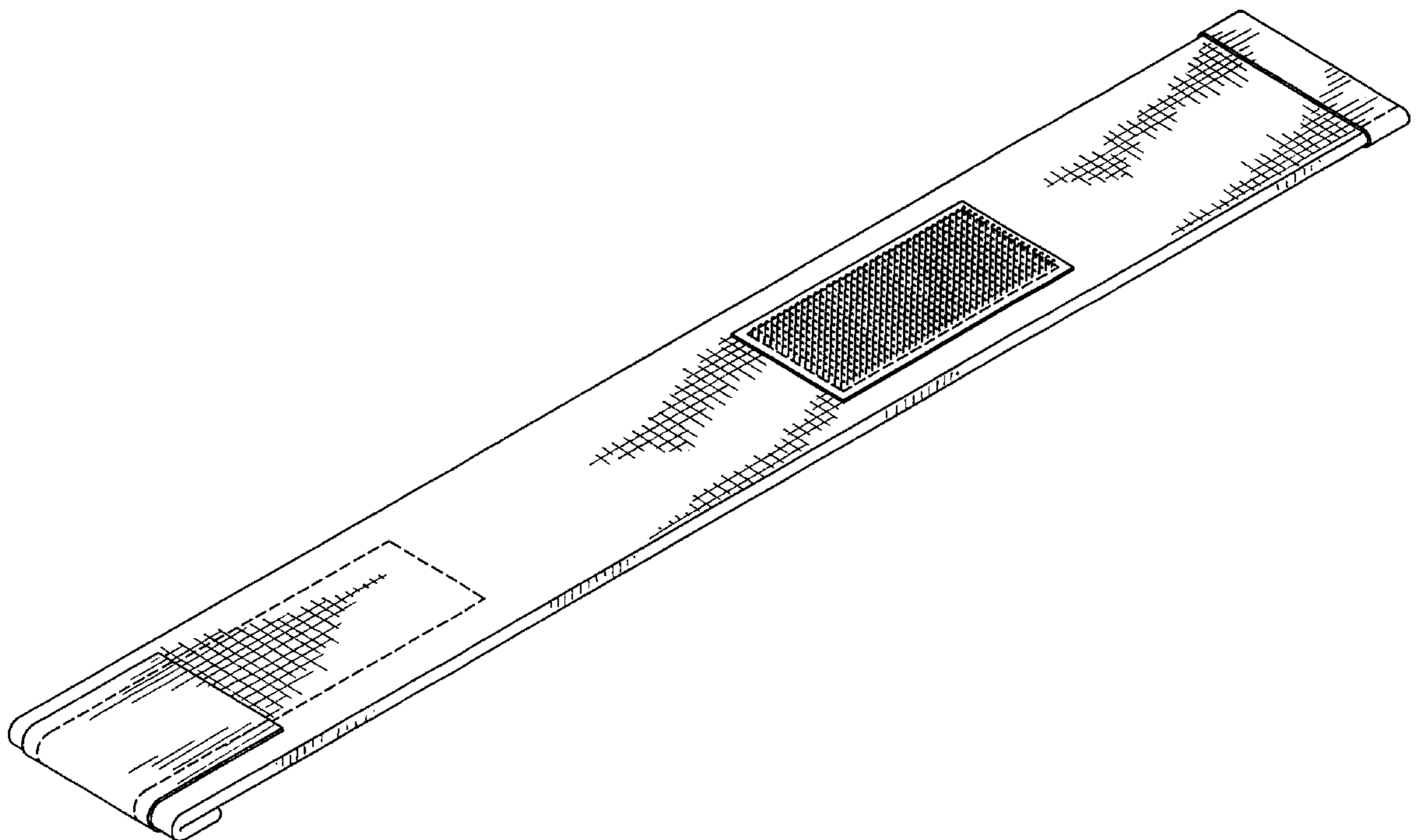

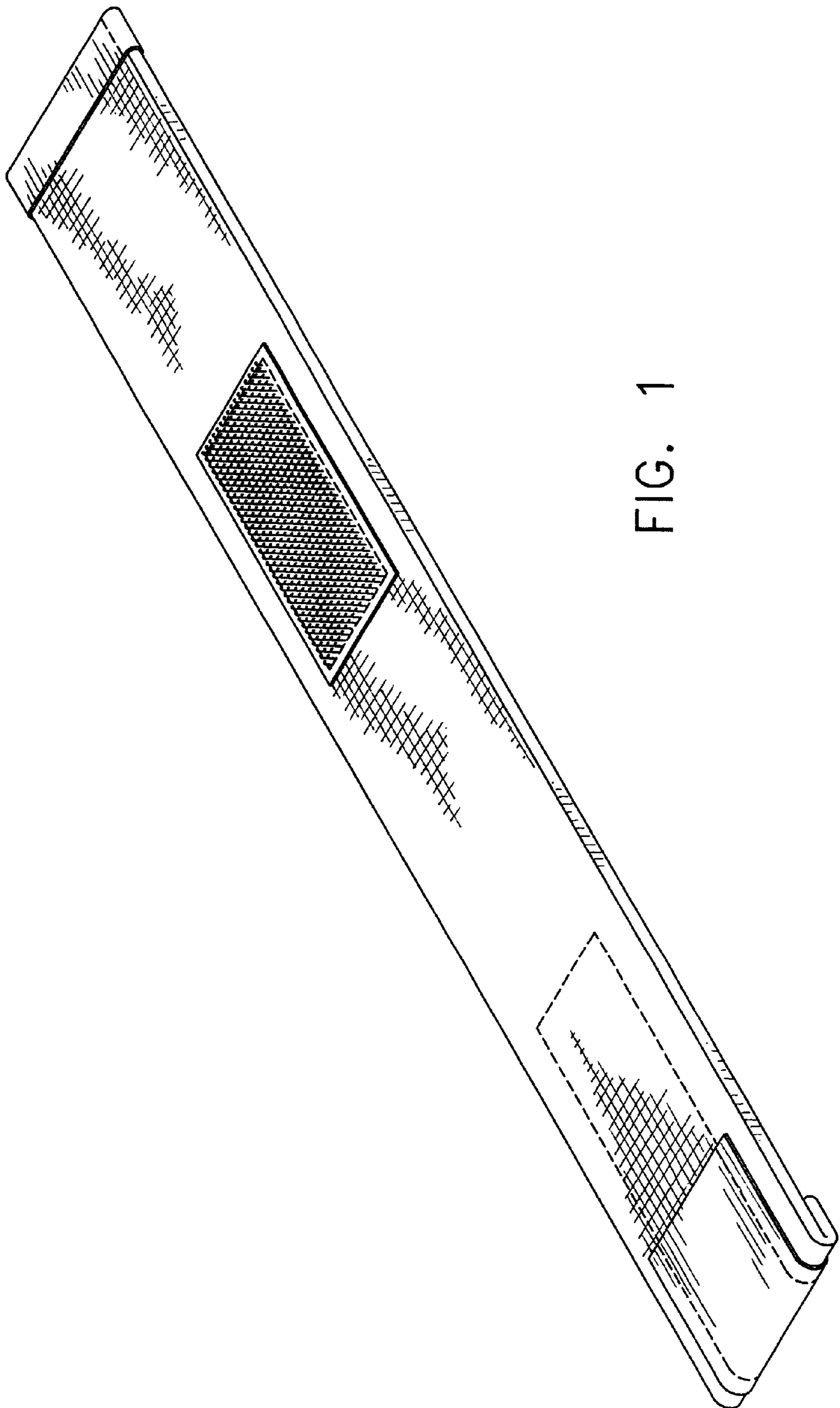

FIG. 1

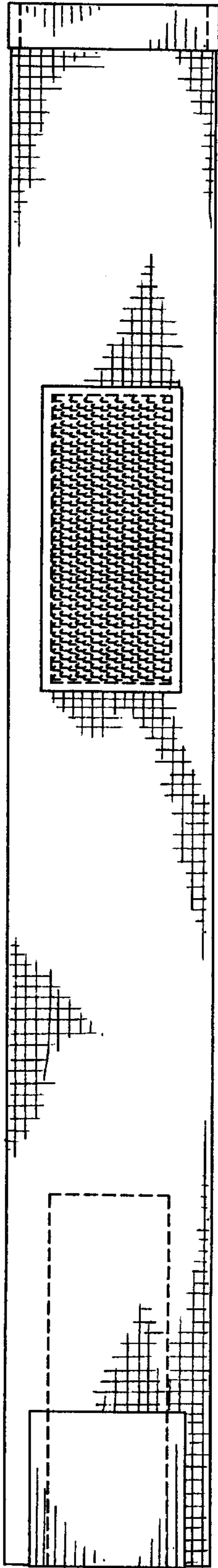

FIG. 2

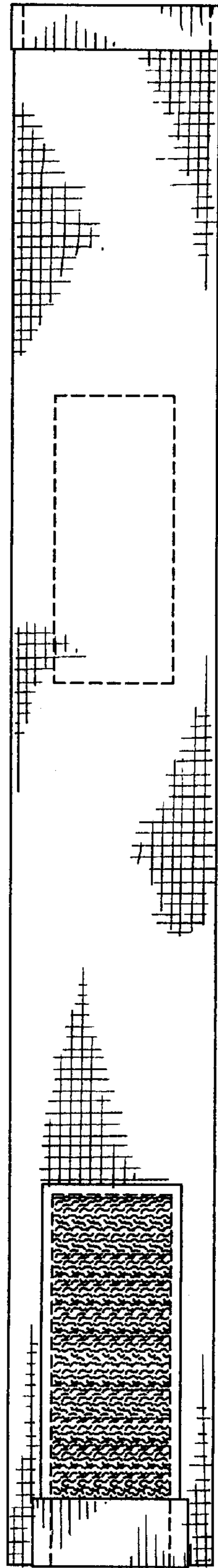

FIG. 3



FIG. 4



FIG. 5

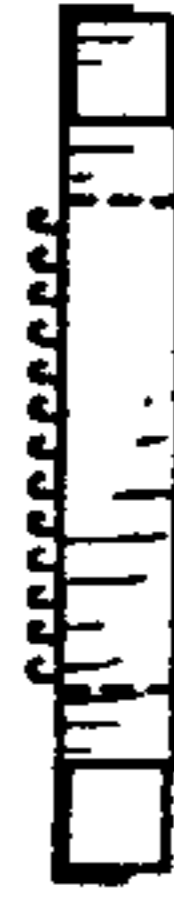

FIG. 6

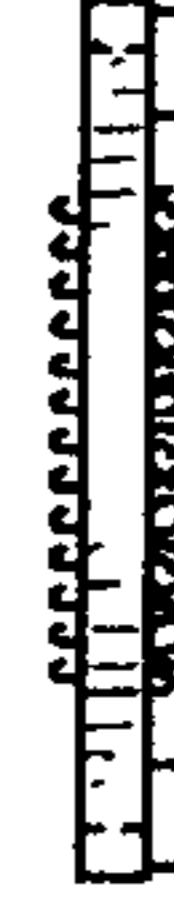

FIG. 7



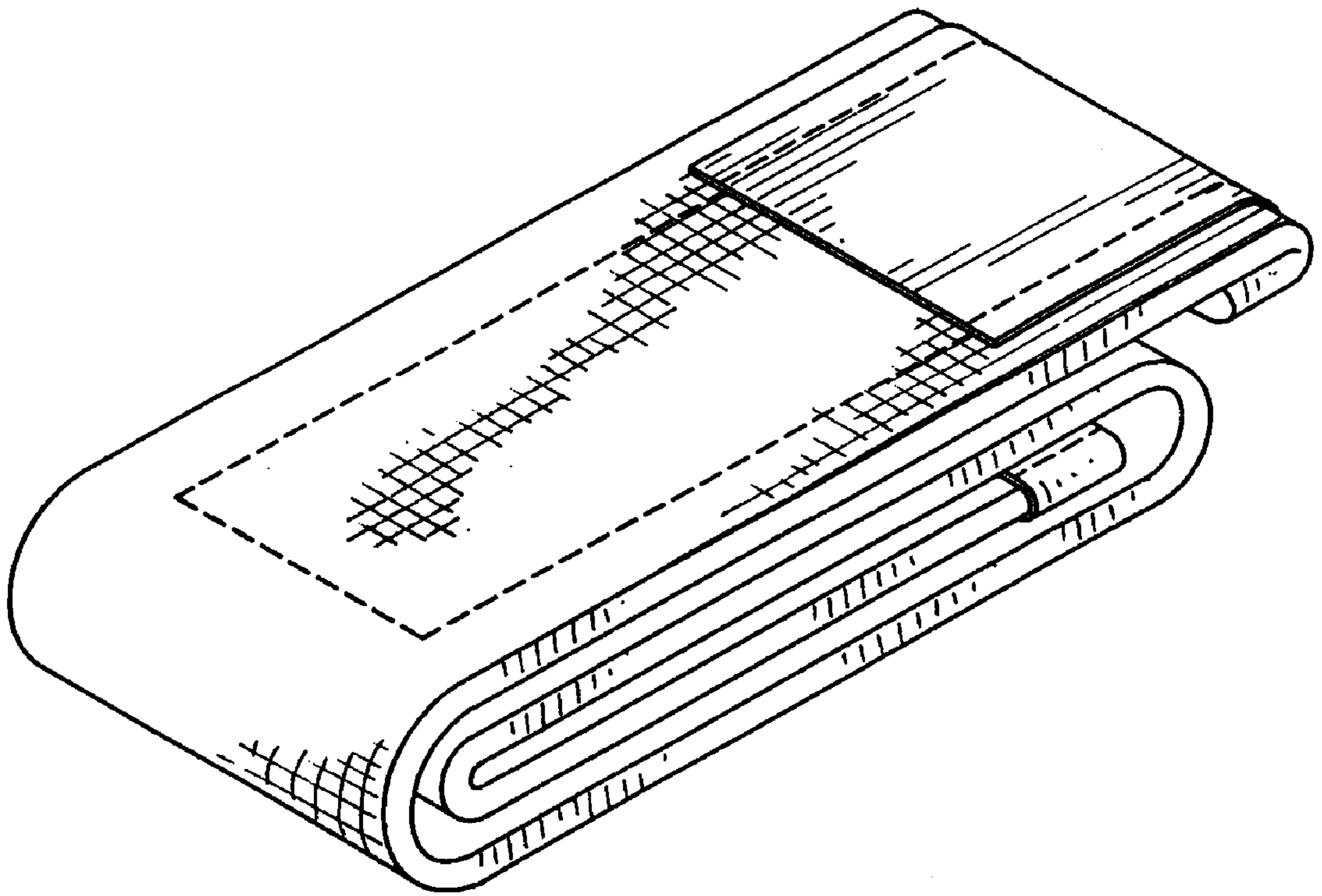

FIG. 8

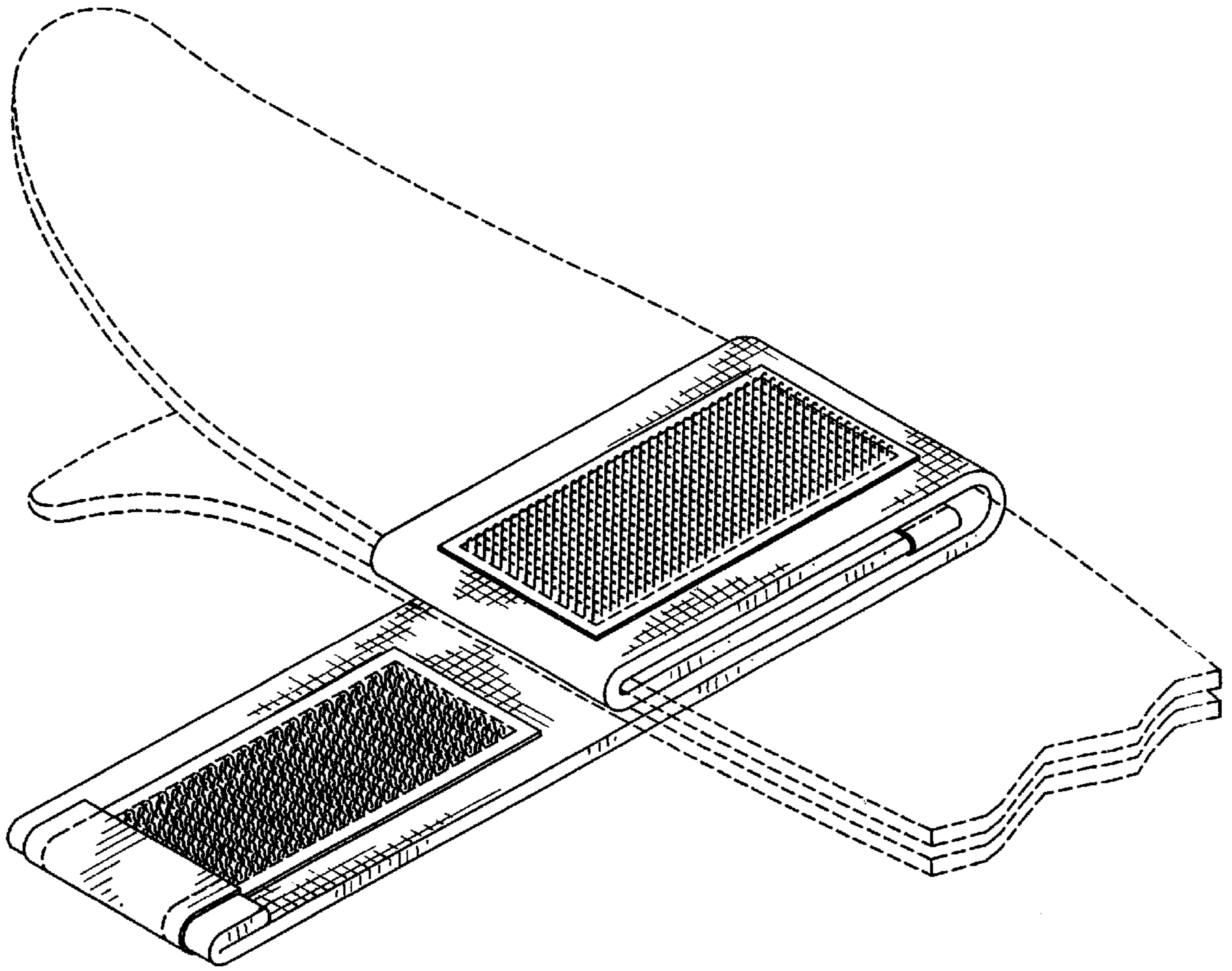

FIG. 9

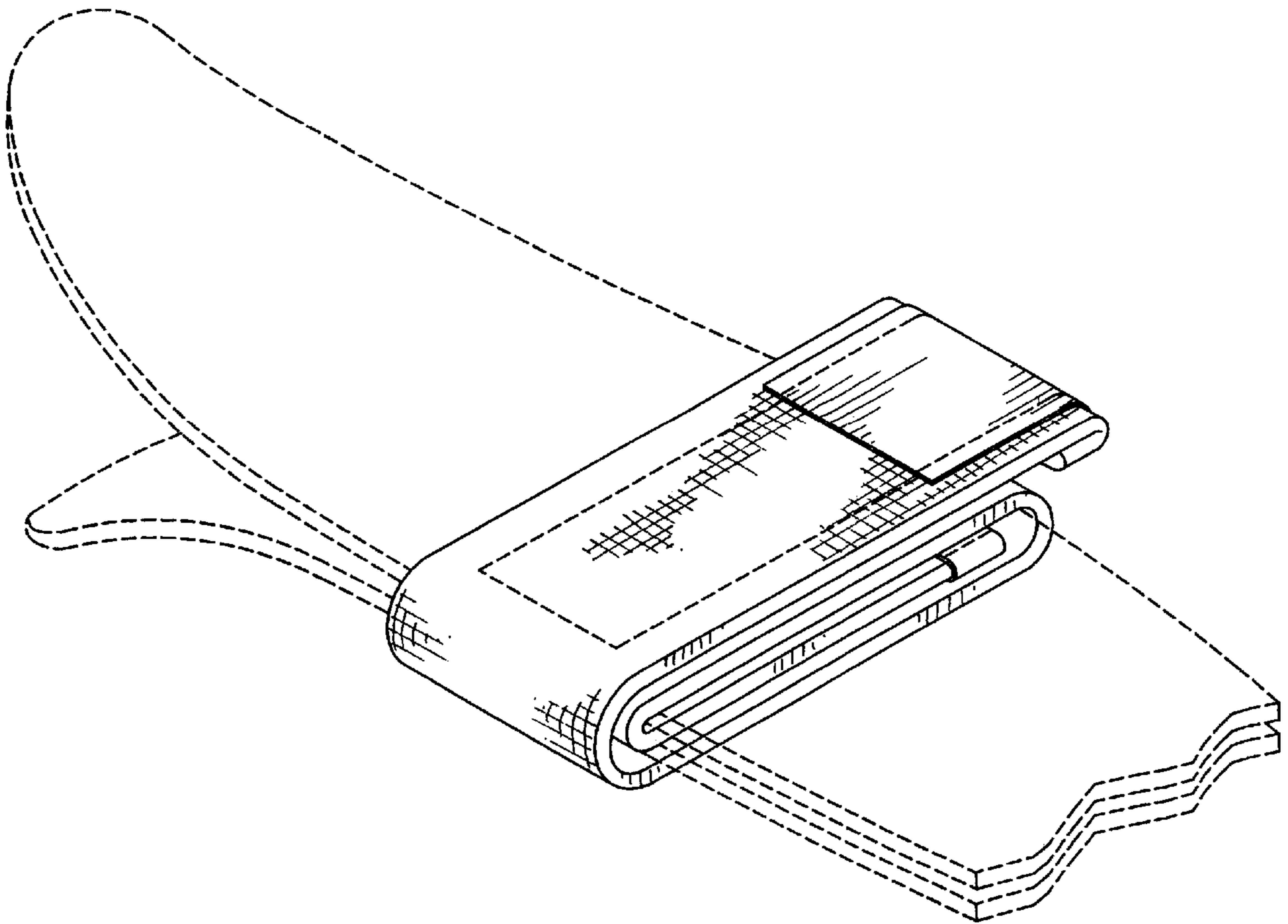

FIG. 10