



US00D453349S

(12) **United States Design Patent**  
**Miyazawa**

(10) **Patent No.:** **US D453,349 S**

(45) **Date of Patent:** **\*\* Feb. 5, 2002**

(54) **VIDEO CAMERA WITH VIDEO TAPE RECORDER**

D425,090 S \* 5/2000 Tashiro ..... D16/202  
D438,225 S \* 2/2001 Sekine ..... D16/202  
D438,553 S \* 3/2001 Sekine et al. .... D16/202

(75) Inventor: **Yoshihiro Miyazawa, Tokyo (JP)**

\* cited by examiner

(73) Assignee: **Canon Kabushiki Kaisha, Tokyo (JP)**

*Primary Examiner*—Adir Aronovich

(\*\*) Term: **14 Years**

(74) *Attorney, Agent, or Firm*—Fitzpatrick, Cella, Harper & Scinto

(21) Appl. No.: **29/142,032**

(57) **CLAIM**

(22) Filed: **May 18, 2001**

The ornamental design for a video camera with video tape recorder, as shown and described.

(30) **Foreign Application Priority Data**

**DESCRIPTION**

Nov. 22, 2000 (JP) ..... 2000-033320

(51) **LOC (7) Cl.** ..... **16-01**

(52) **U.S. Cl.** ..... **D16/202**

(58) **Field of Search** ..... D16/200–206,  
D16/208, 218; 348/373–376; 358/906; 396/535–541

FIG. 1 is a front view of a video camera with video tape recorder showing my new design;  
FIG. 2 is a rear view thereof;  
FIG. 3 is a top plan view thereof;  
FIG. 4 is a bottom plan view thereof;  
FIG. 5 is a left side view thereof;  
FIG. 6 is a right side view thereof; and,  
FIG. 7 is a perspective view thereof.

(56) **References Cited**

**U.S. PATENT DOCUMENTS**

5,499,052 A \* 3/1996 Nakanishi et al. .... 348/373  
D422,001 S \* 3/2000 Ohwada ..... D16/202

**1 Claim, 4 Drawing Sheets**

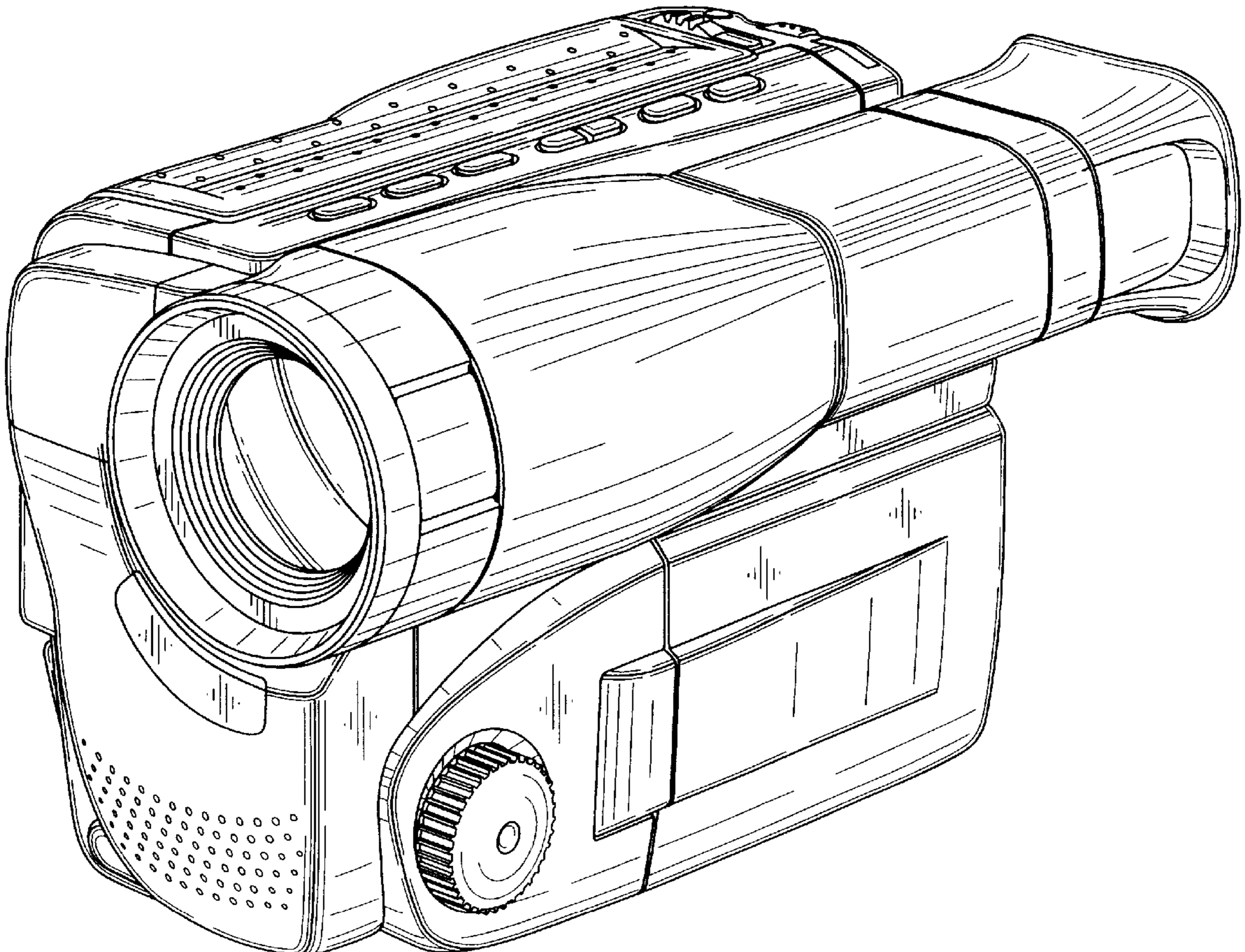

*FIG. 1*

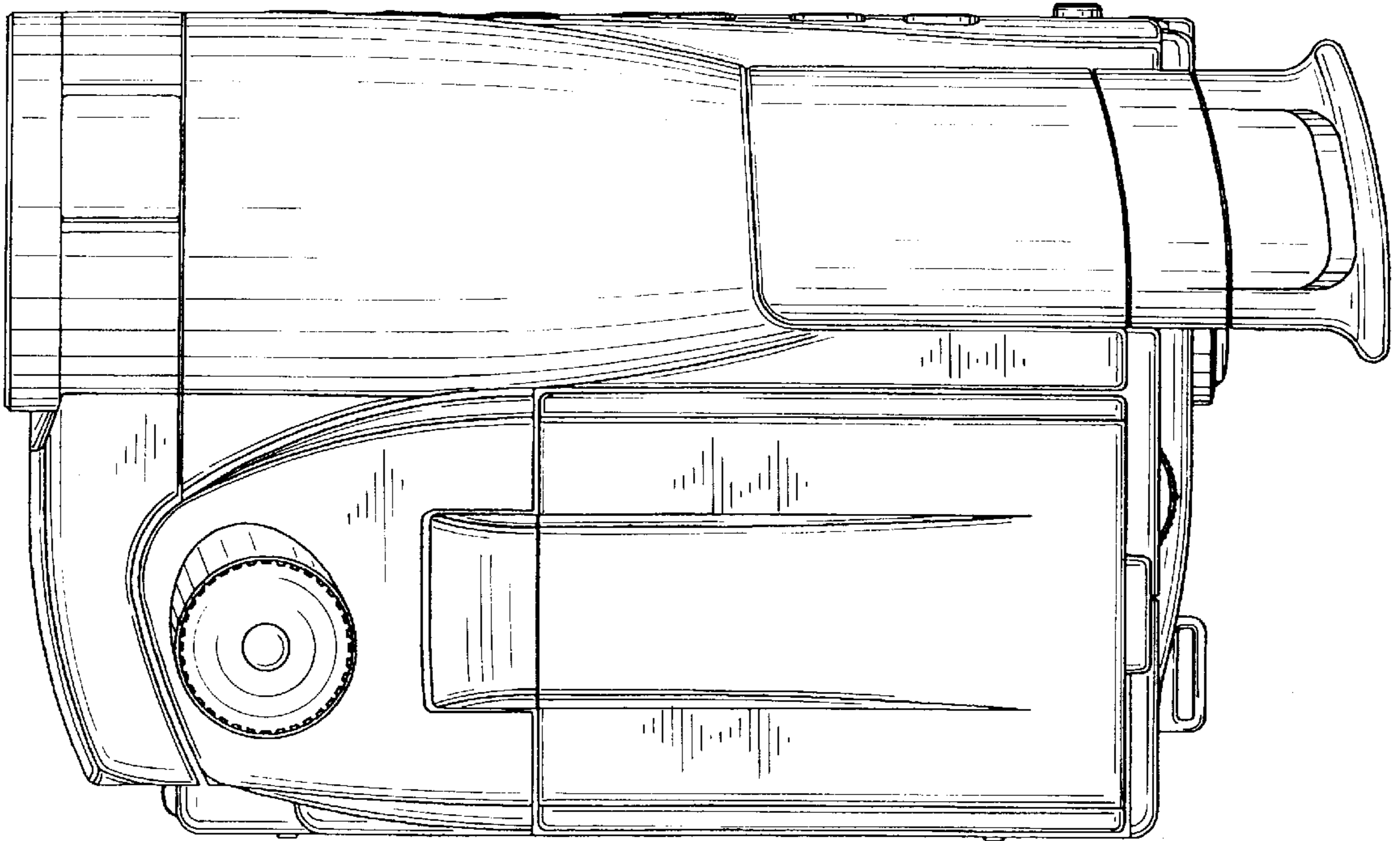

*FIG. 2*

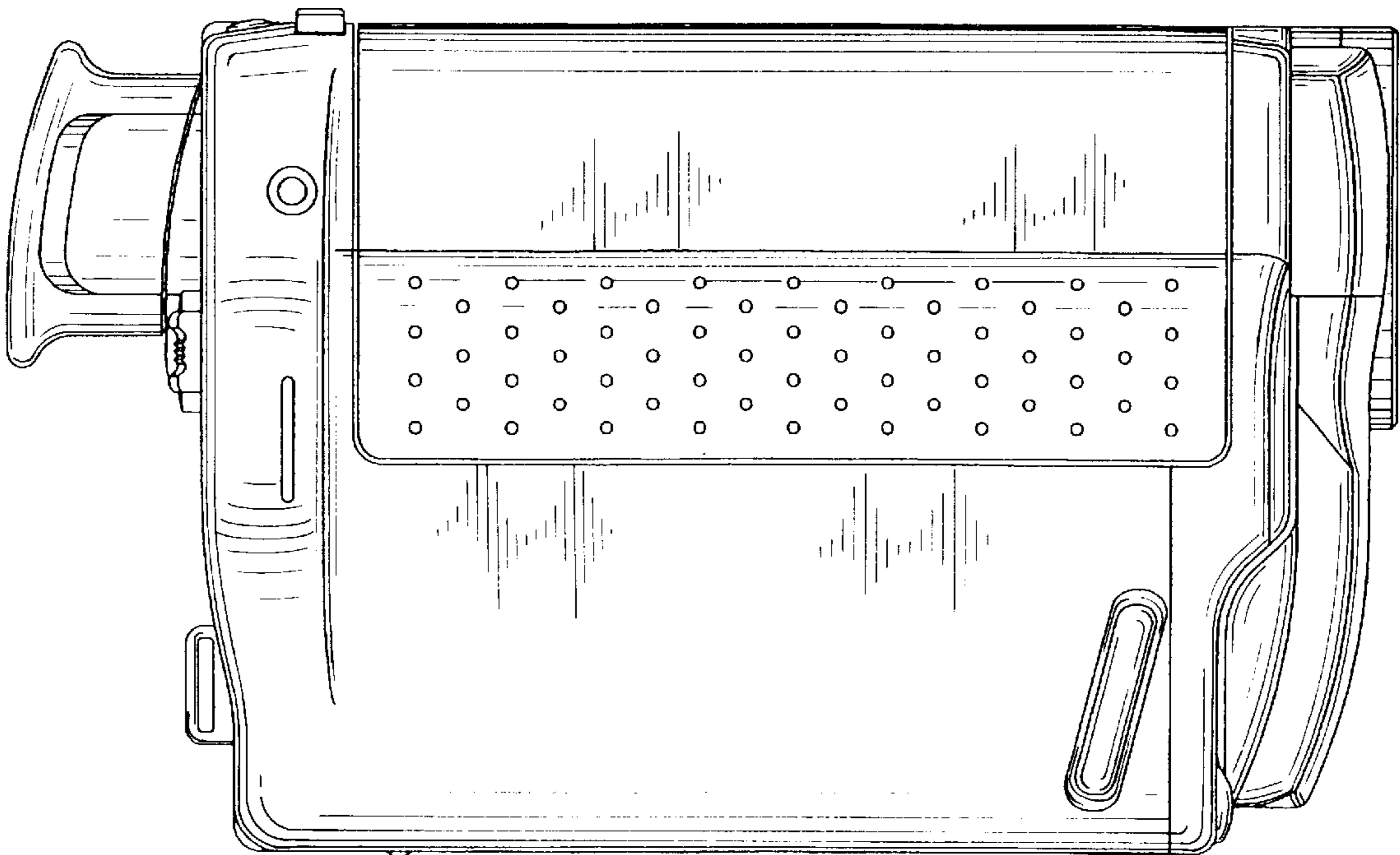

*FIG. 3*

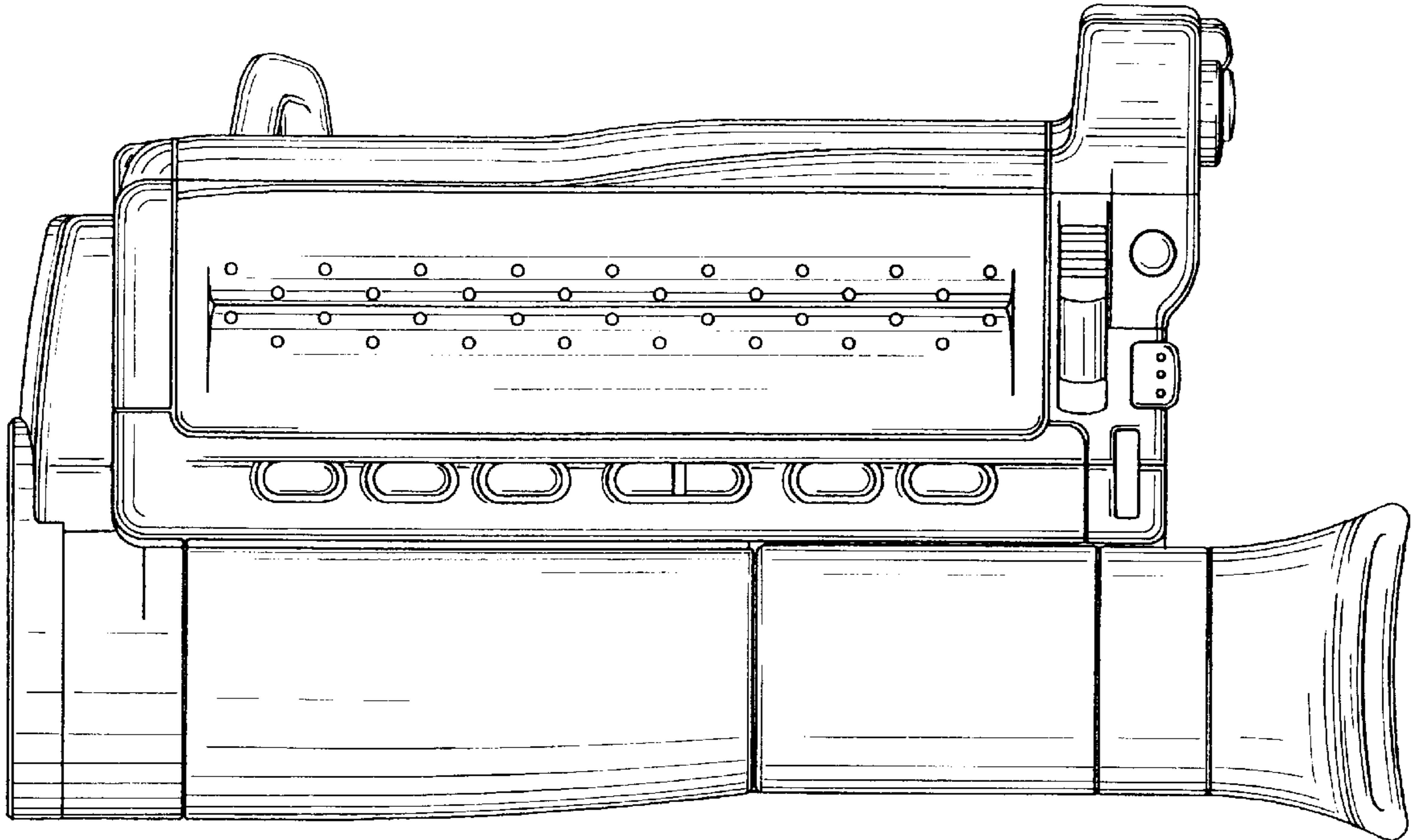

*FIG. 4*

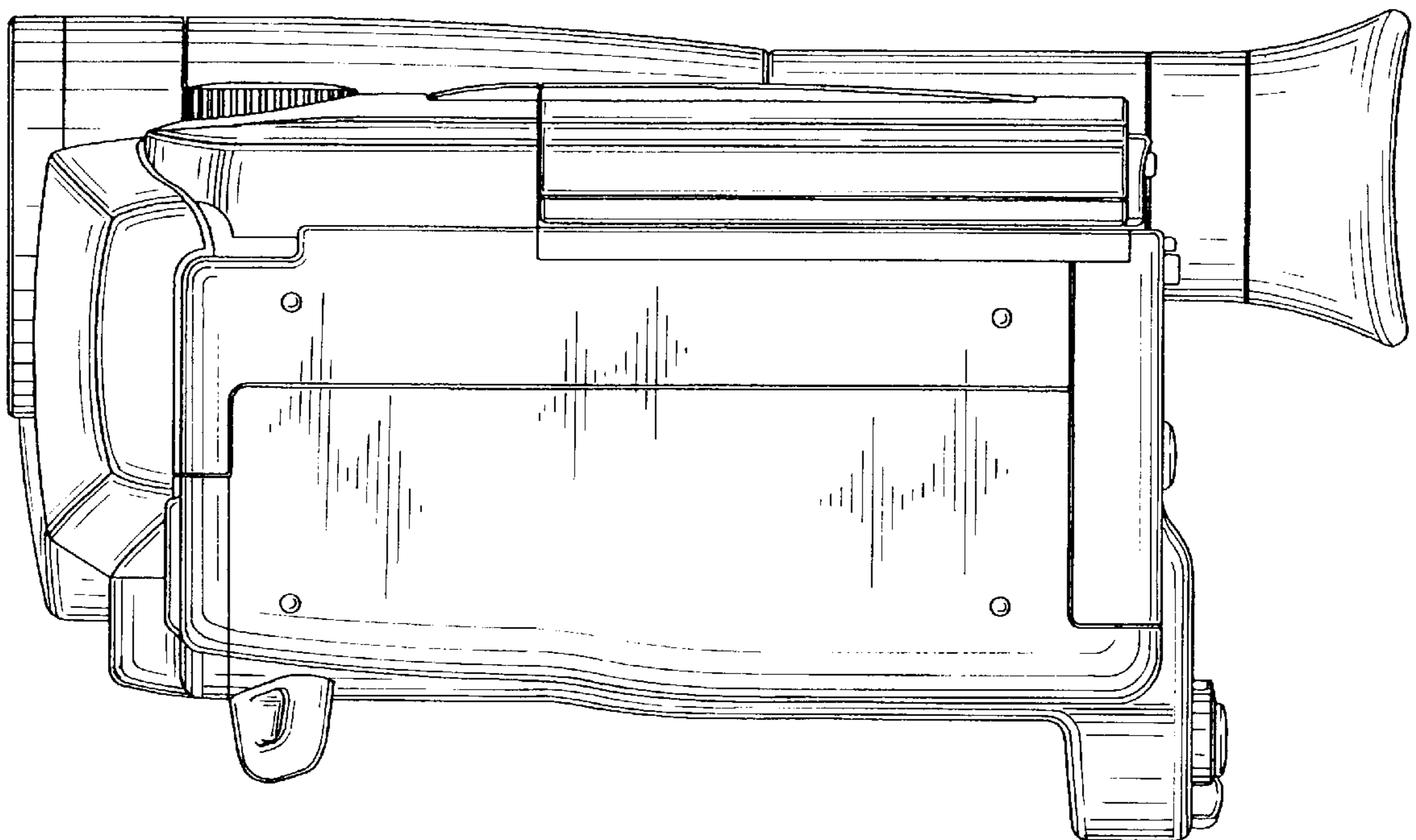

*FIG. 5*

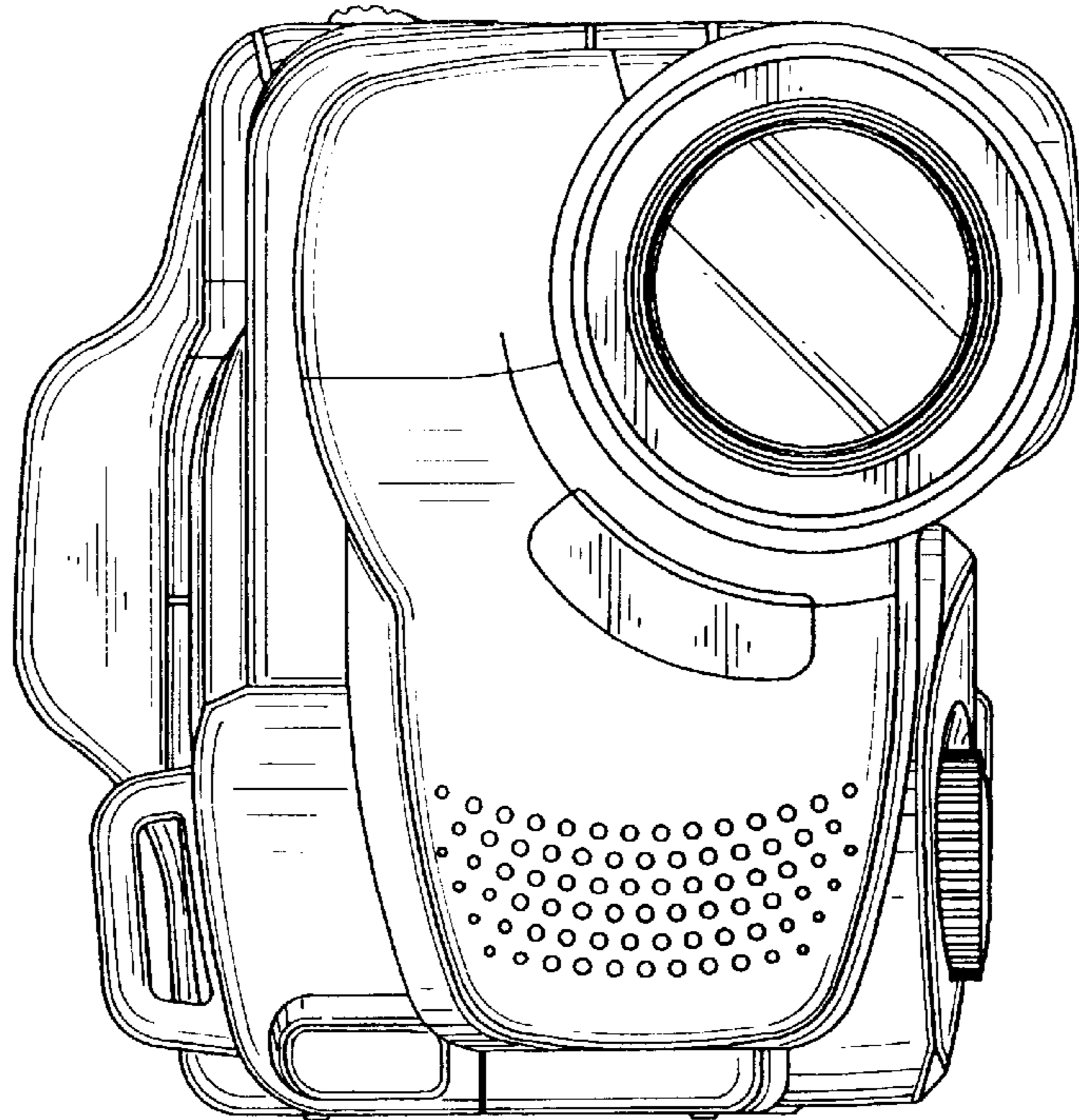

*FIG. 6*

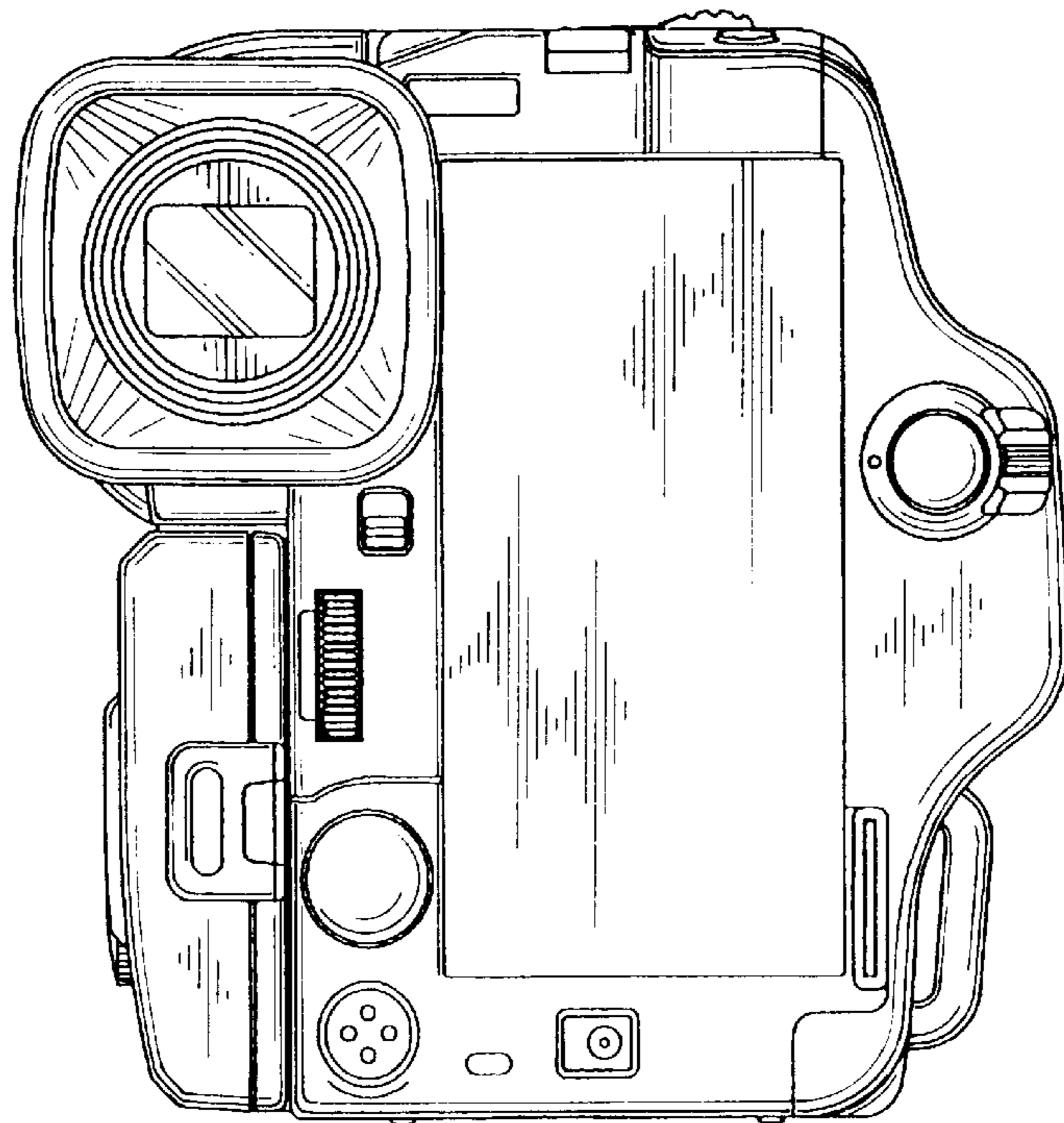

*FIG. 7*

