



US00D453279S

(12) **United States Design Patent**
Huang

(10) **Patent No.:** **US D453,279 S**

(45) **Date of Patent:** **** Feb. 5, 2002**

(54) **VACUUM FLASK**

(76) Inventor: **Frank Teh-Hsiung Huang**, Suite 804,
8F, No. 128, Sec. 3, Ming-Sheng E.
Rd., Taipei (TW)

(**) Term: **14 Years**

(21) Appl. No.: **29/129,327**

(22) Filed: **Sep. 13, 2000**

(51) **LOC (7) Cl.** **07-01**

(52) **U.S. Cl.** **D7/318; D7/317**

(58) **Field of Search** D7/300, 312, 316,
D7/317, 318, 319; 210/282, 470; 222/144.5,
566, 465.1; 99/295

(56) **References Cited**

U.S. PATENT DOCUMENTS

D200,487 S	*	3/1965	Dann, Jr. et al.	D7/317
D281,757 S	*	12/1985	Zimmermann	D7/321
D286,254 S	*	10/1986	Zimmerman	D7/317
D293,538 S	*	1/1988	Zimmermann	D7/317
D364,990 S	*	12/1995	Fonville	D7/317
D386,934 S	*	12/1997	Huang	D7/319
D387,951 S	*	12/1997	Huang	D7/319
D394,981 S	*	6/1998	Huang	D7/319
D417,814 S	*	12/1999	Huang	D7/319
D420,545 S	*	2/2000	Huang	D7/318
D444,338 S	*	7/2001	Huang	D7/318

* cited by examiner

Primary Examiner—M. N. Pandozzi

(74) *Attorney, Agent, or Firm*—Bacon & Thomas, PLLC

(57) **CLAIM**

The ornamental design for vacuum flask, as shown and described.

DESCRIPTION

FIG. 1 is a perspective view of vacuum flask showing our new design thereof;

FIG. 2 is a right side elevational view of FIG. 1;

FIG. 3 is a top plan view of FIG. 1;

FIG. 4 is a front elevational view and the rear elevational view being a mirror image of FIG. 1;

FIG. 5 is a bottom plan view of FIG. 1;

FIG. 6 is a left side elevational view of FIG. 1;

FIG. 7 is a perspective view of vacuum flask of an alternate embodiment thereof, the only difference residing in the handle of the article;

FIG. 8 is a right side elevational view of FIG. 7;

FIG. 9 is a top plan view of FIG. 7;

FIG. 10 is a front elevational view and the rear side elevational view being a mirror image of FIG. 7;

FIG. 11 is a bottom plan view of FIG. 7; and,

FIG. 12 is a left side elevational view of FIG. 7.

1 Claim, 12 Drawing Sheets

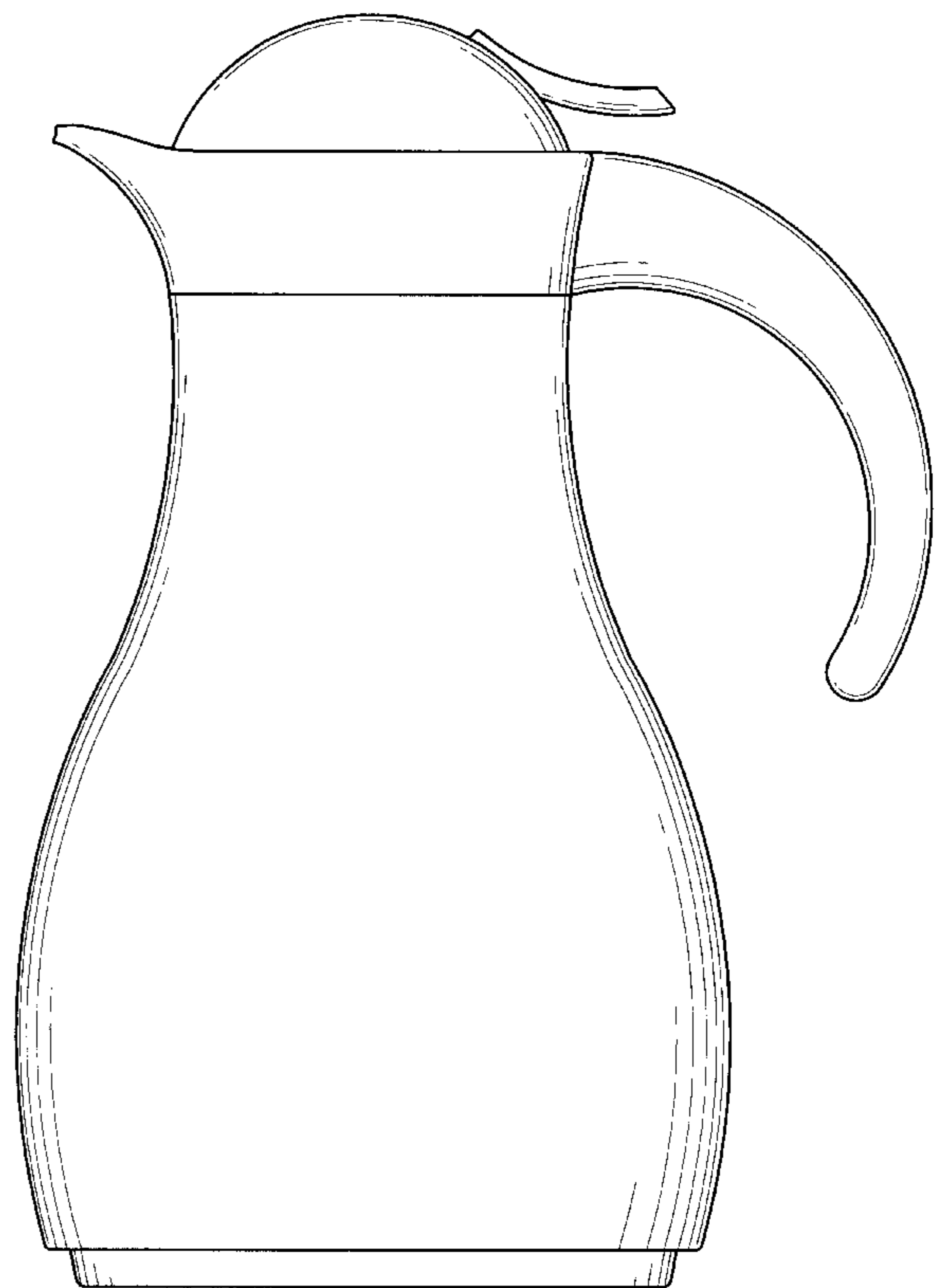
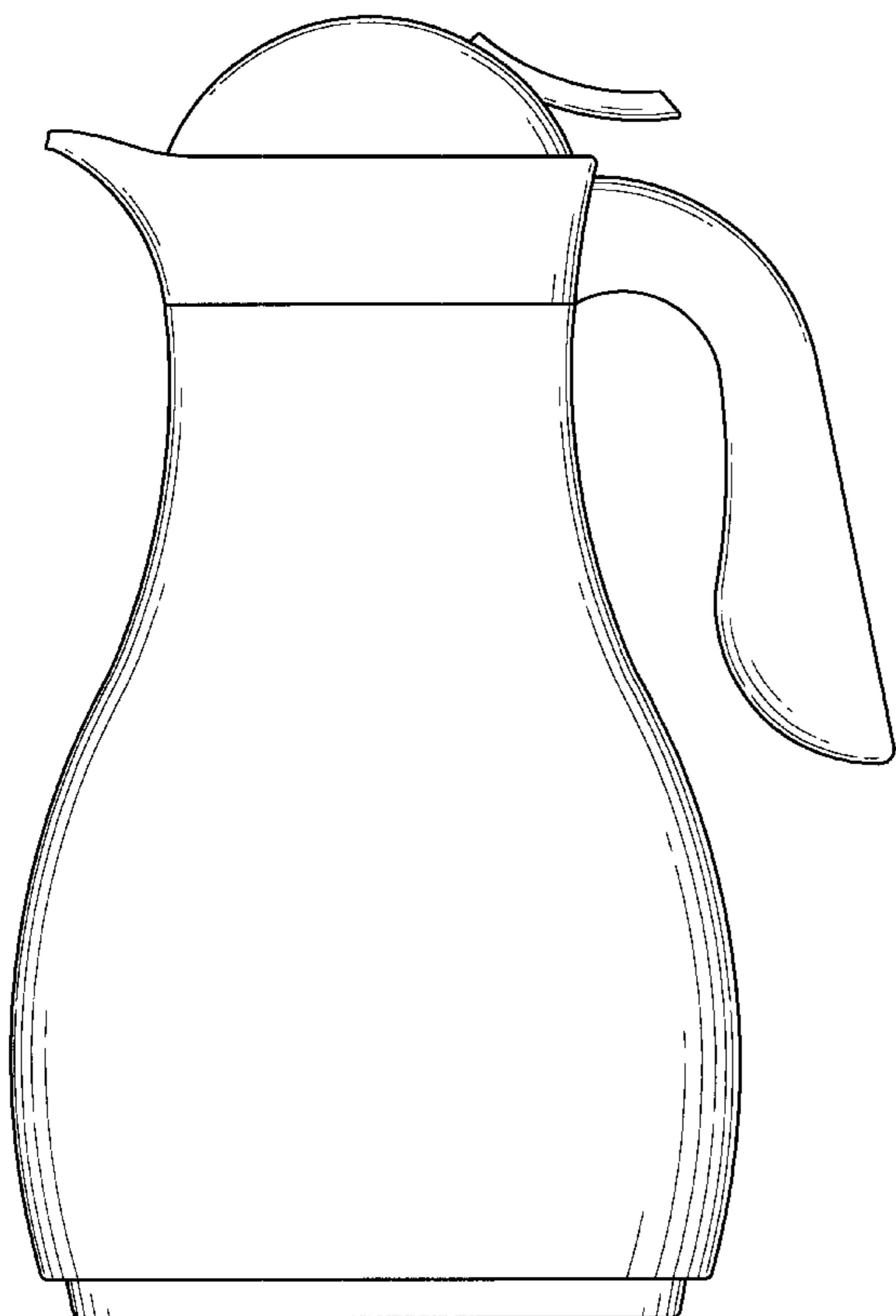

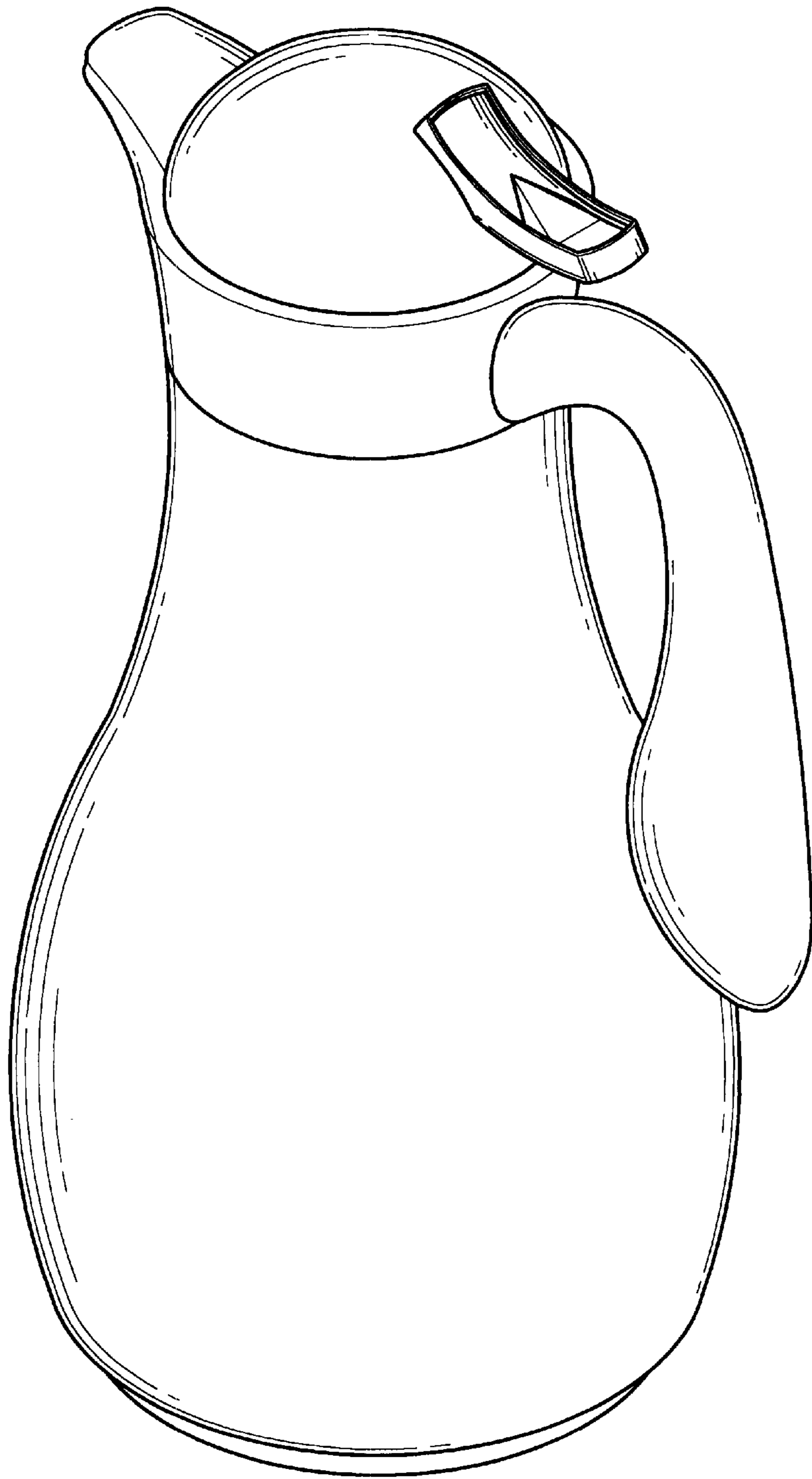

Fig. 1

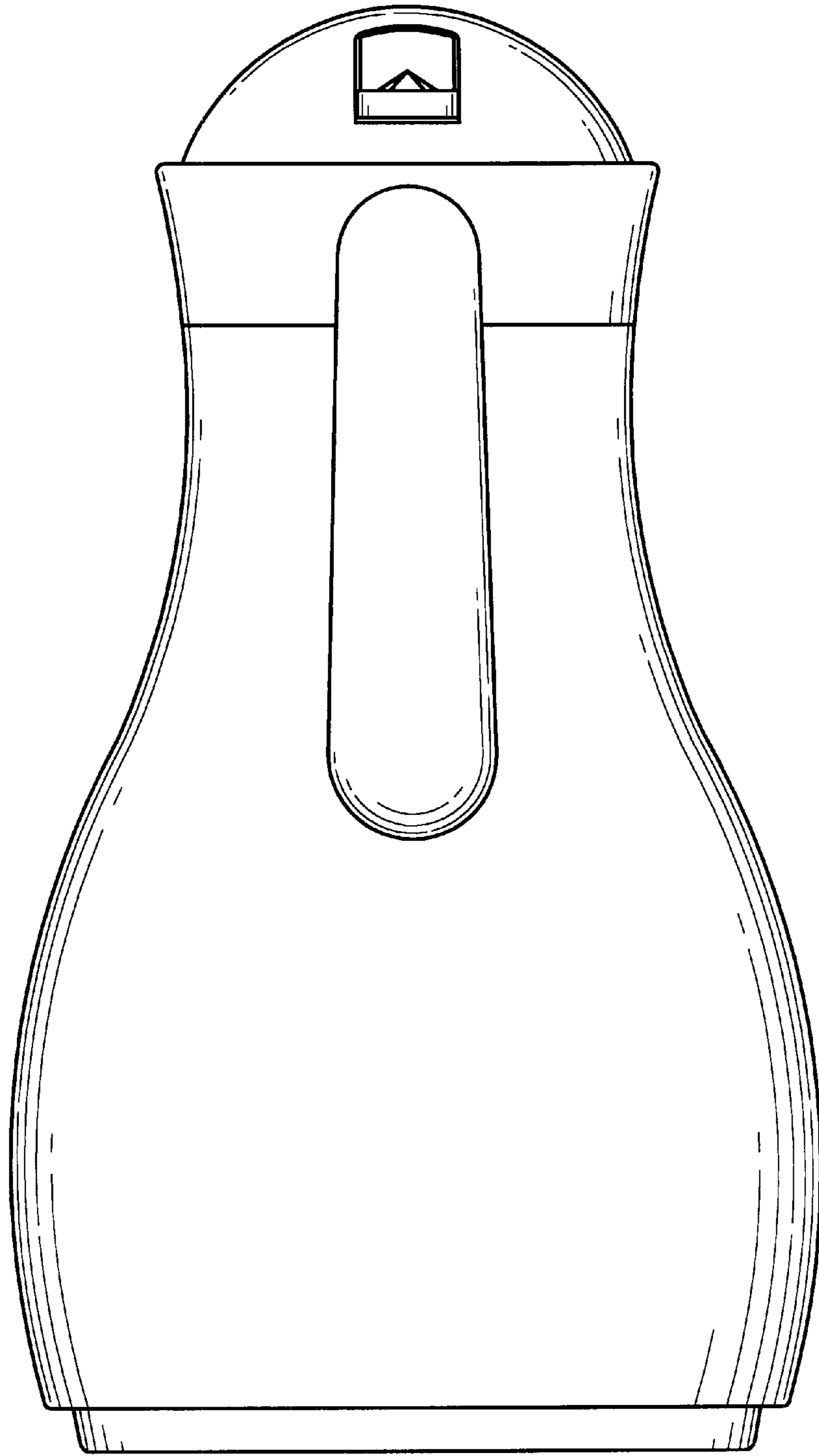

Fig. 2

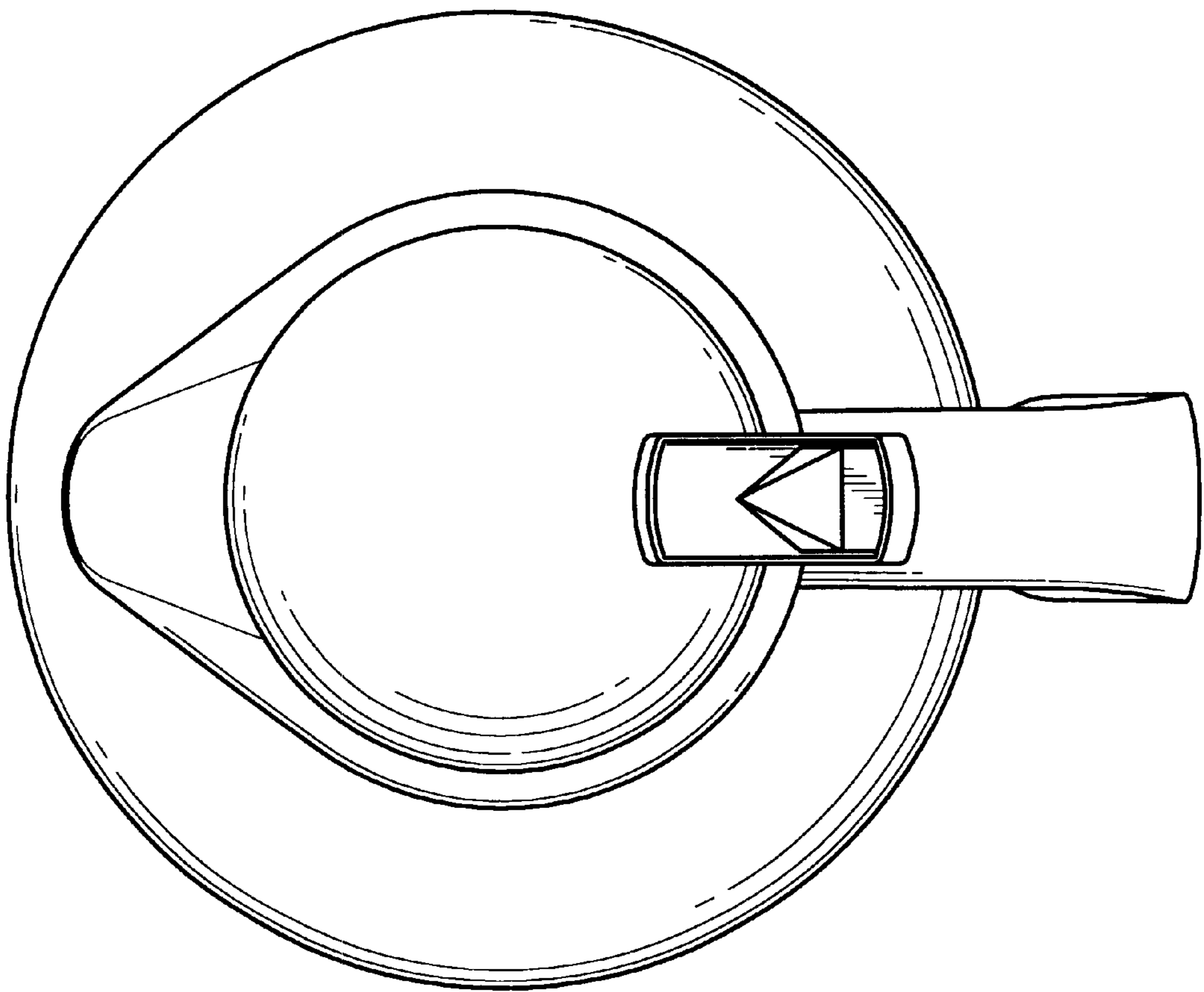

Fig. 3

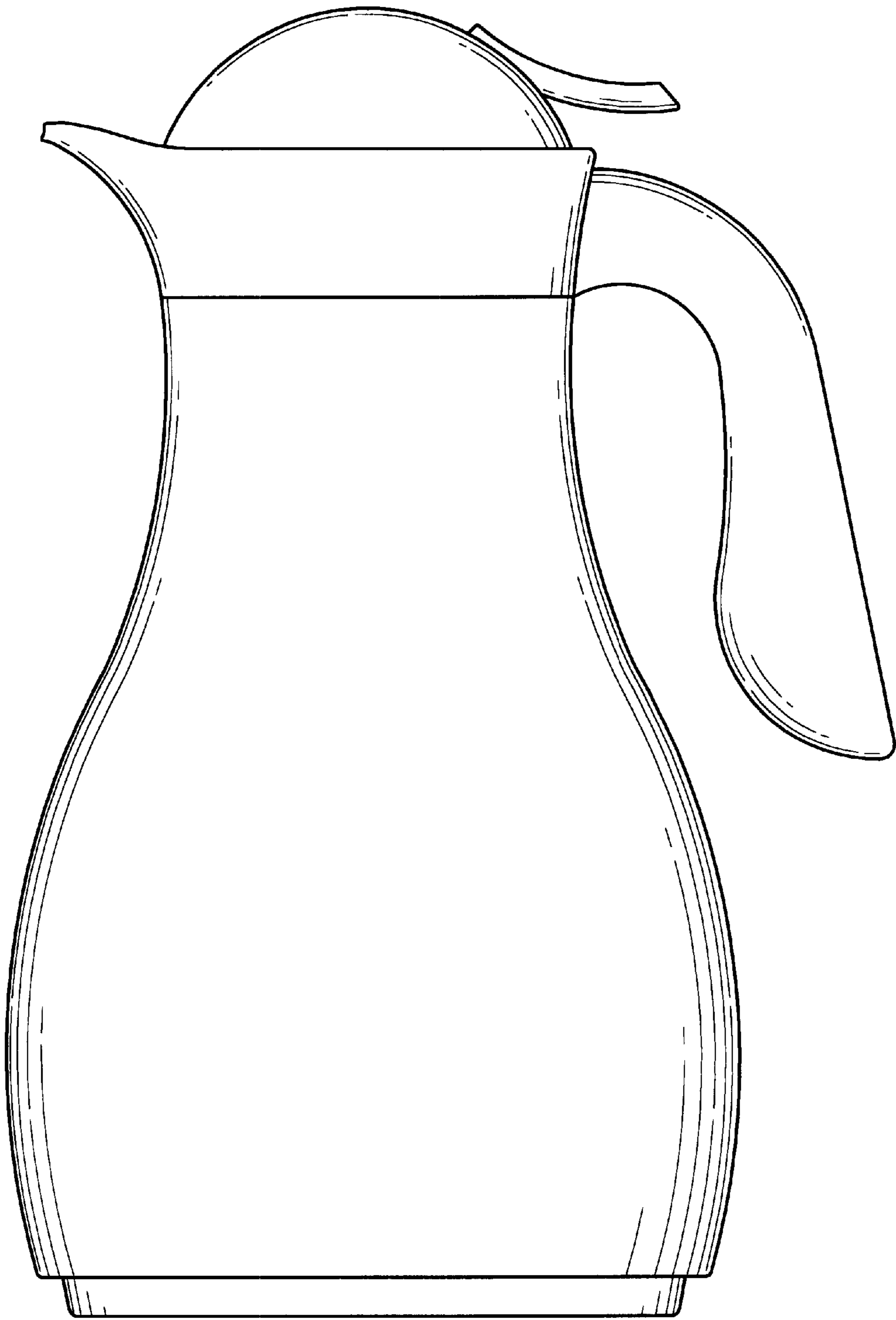

Fig. 4

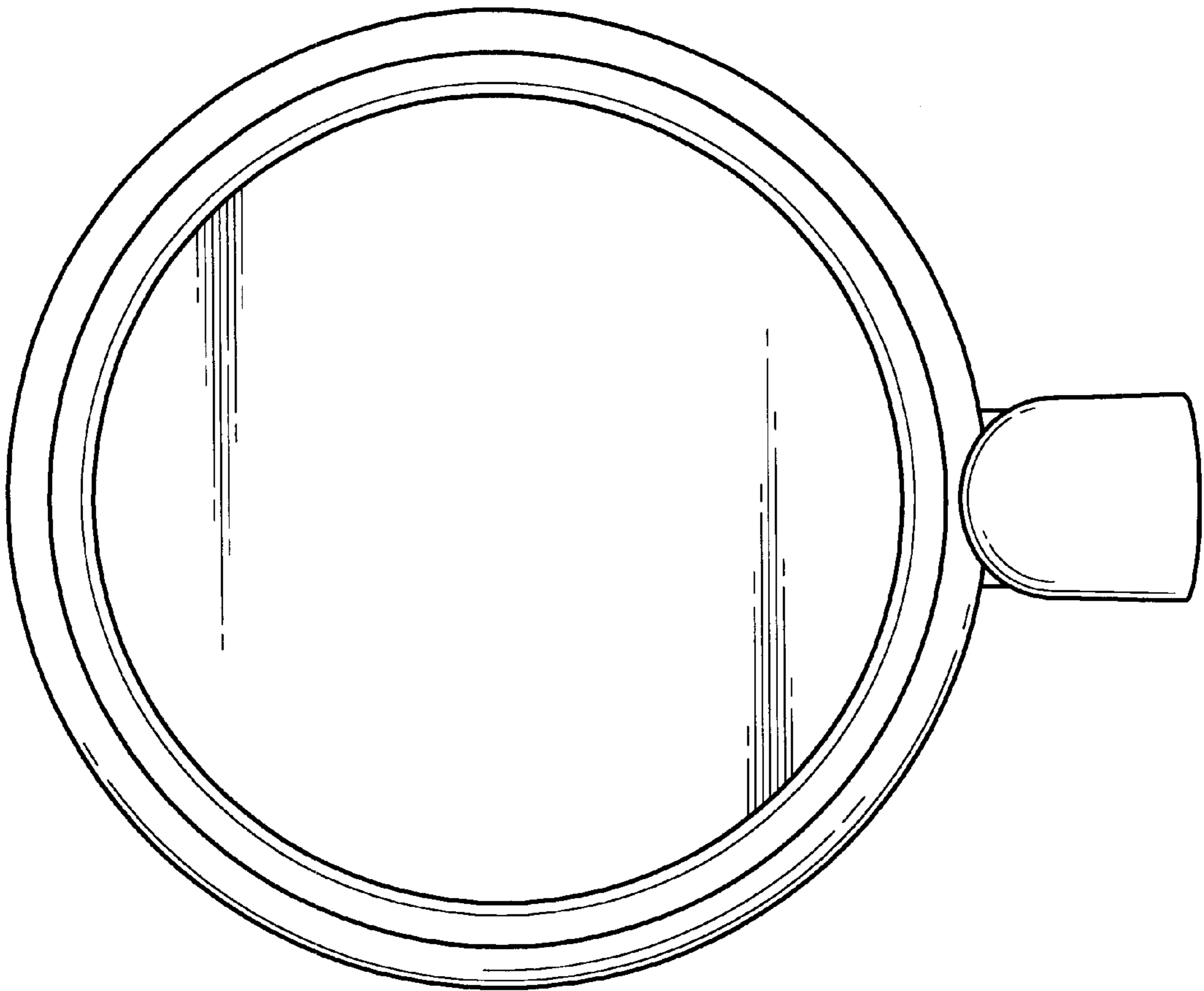

Fig. 5

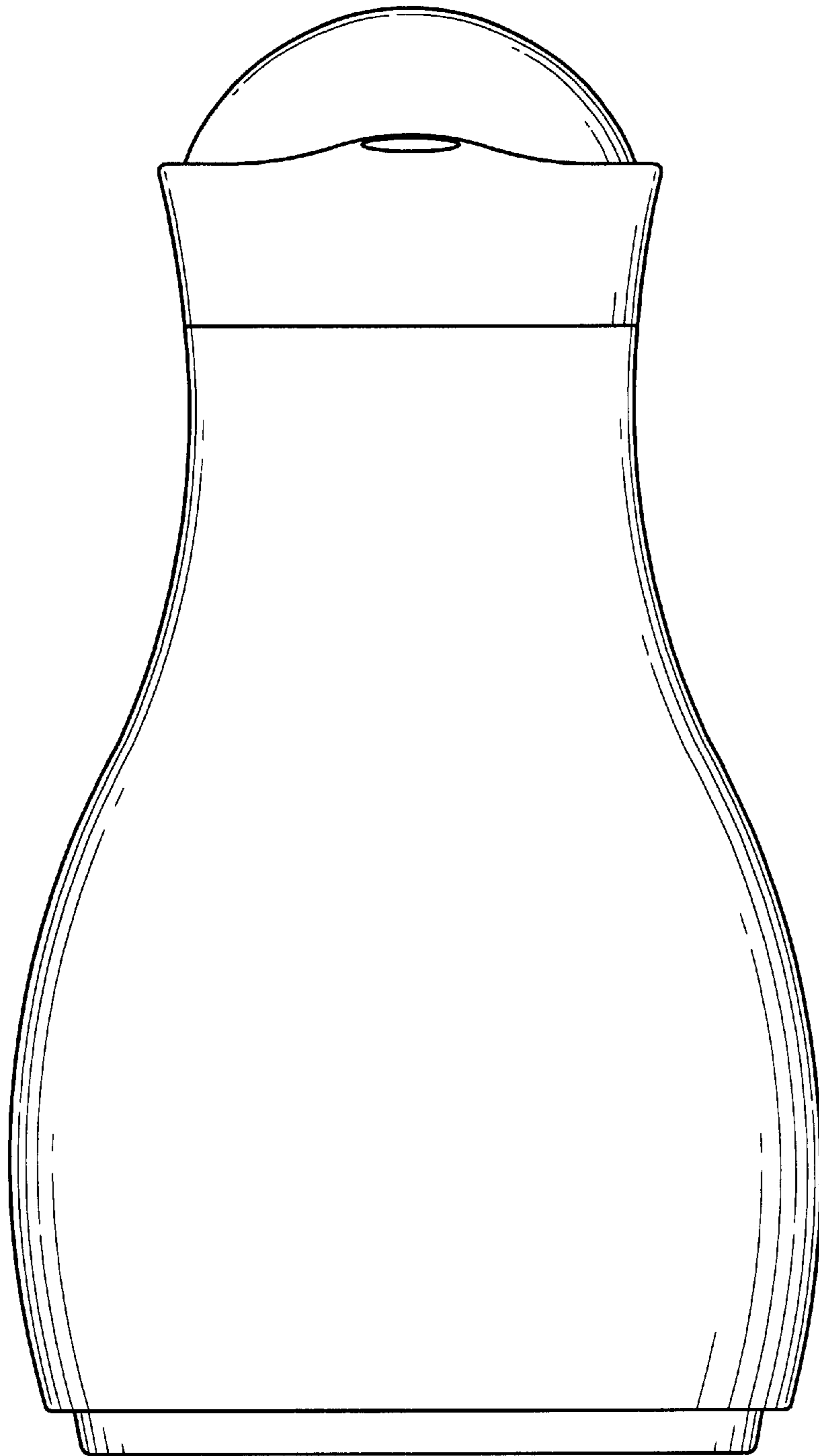

Fig. 6

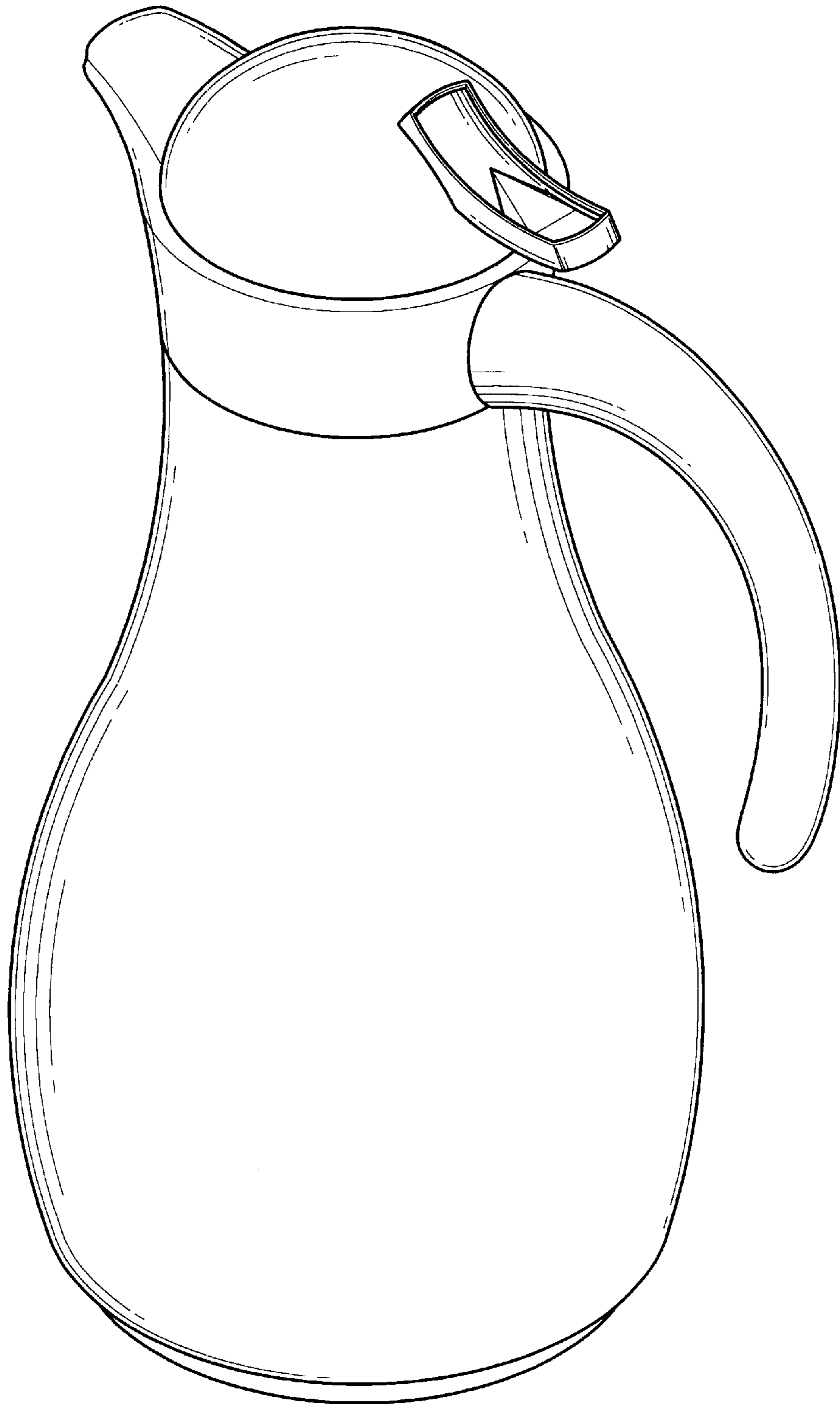

Fig. 7

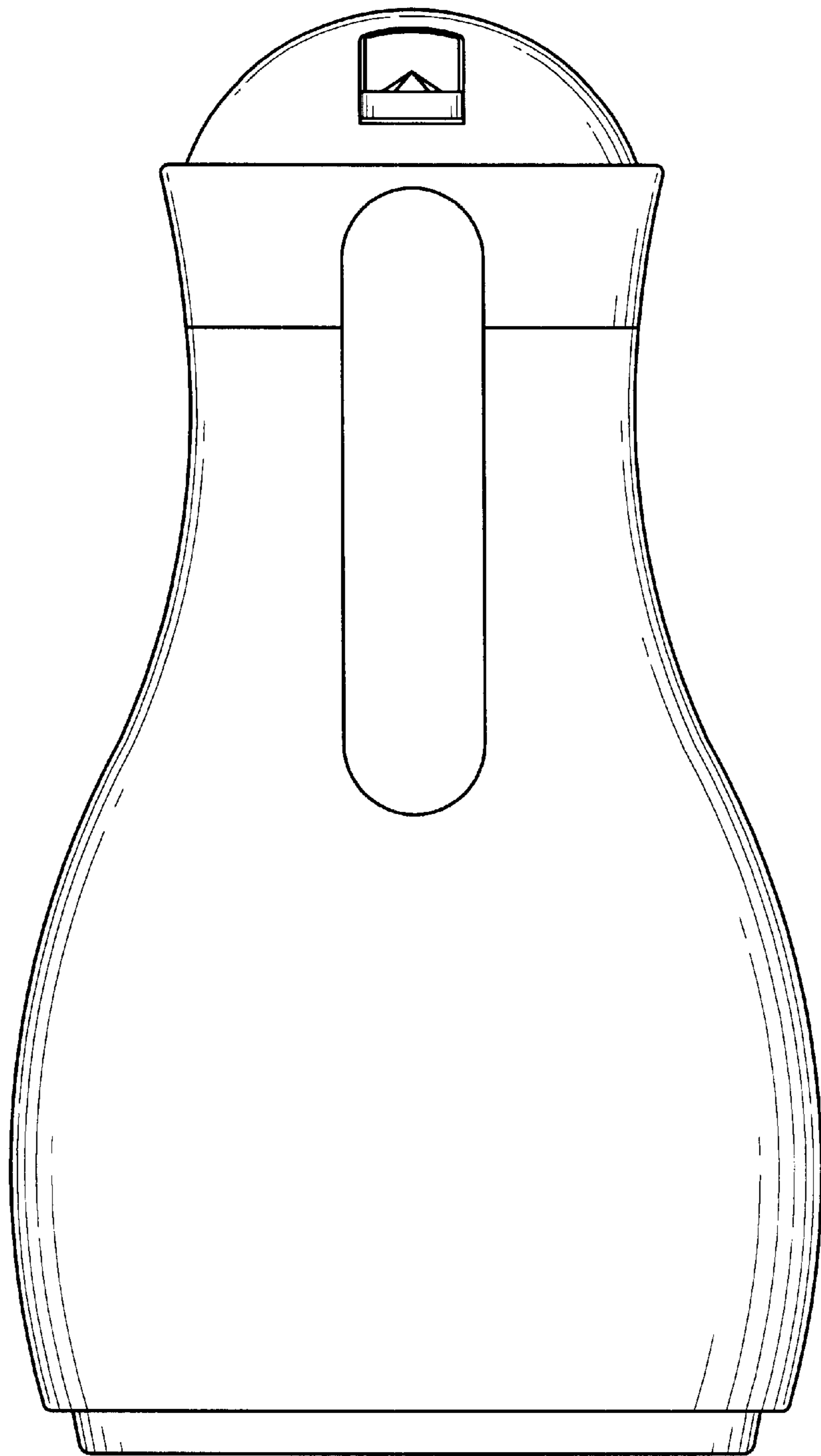

Fig. 8

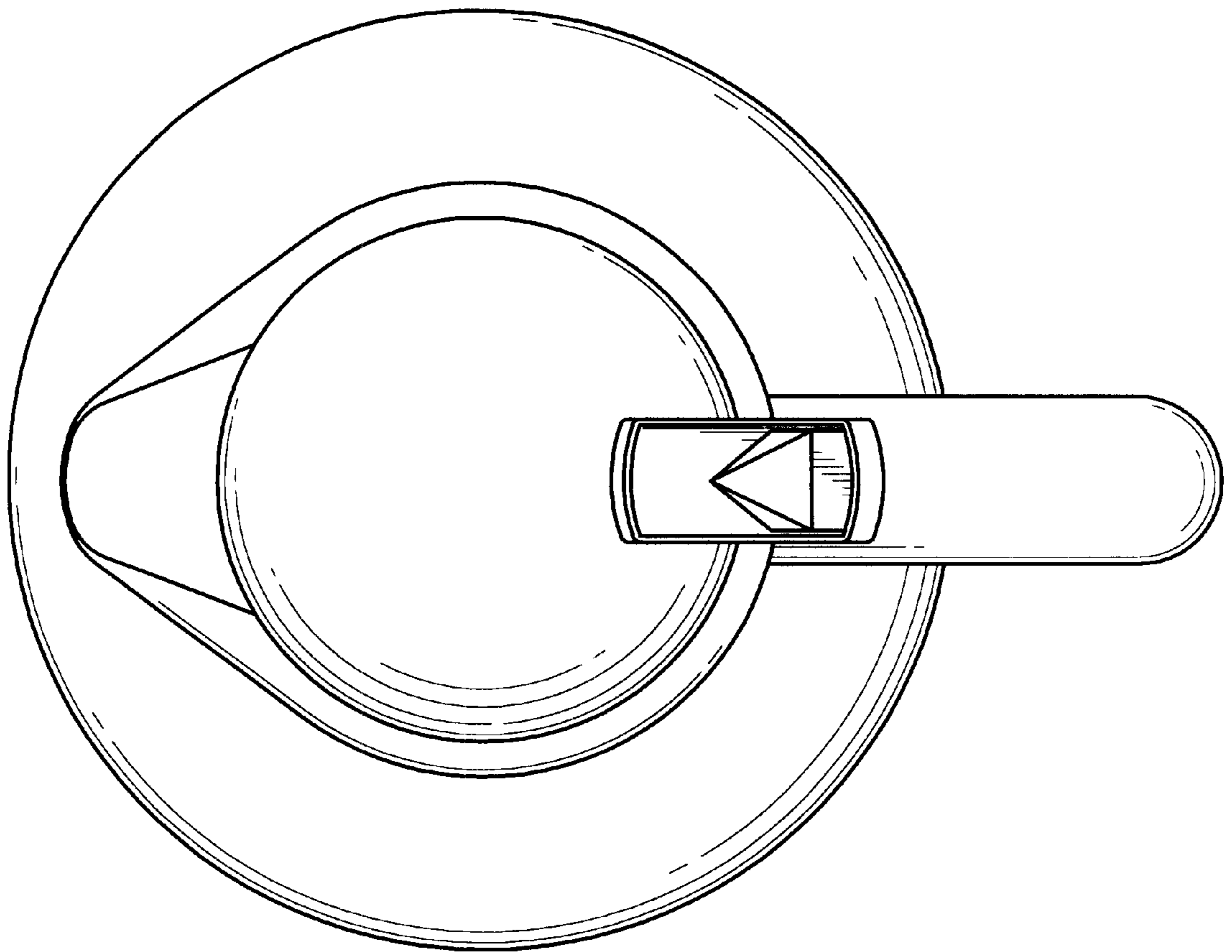

Fig. 9

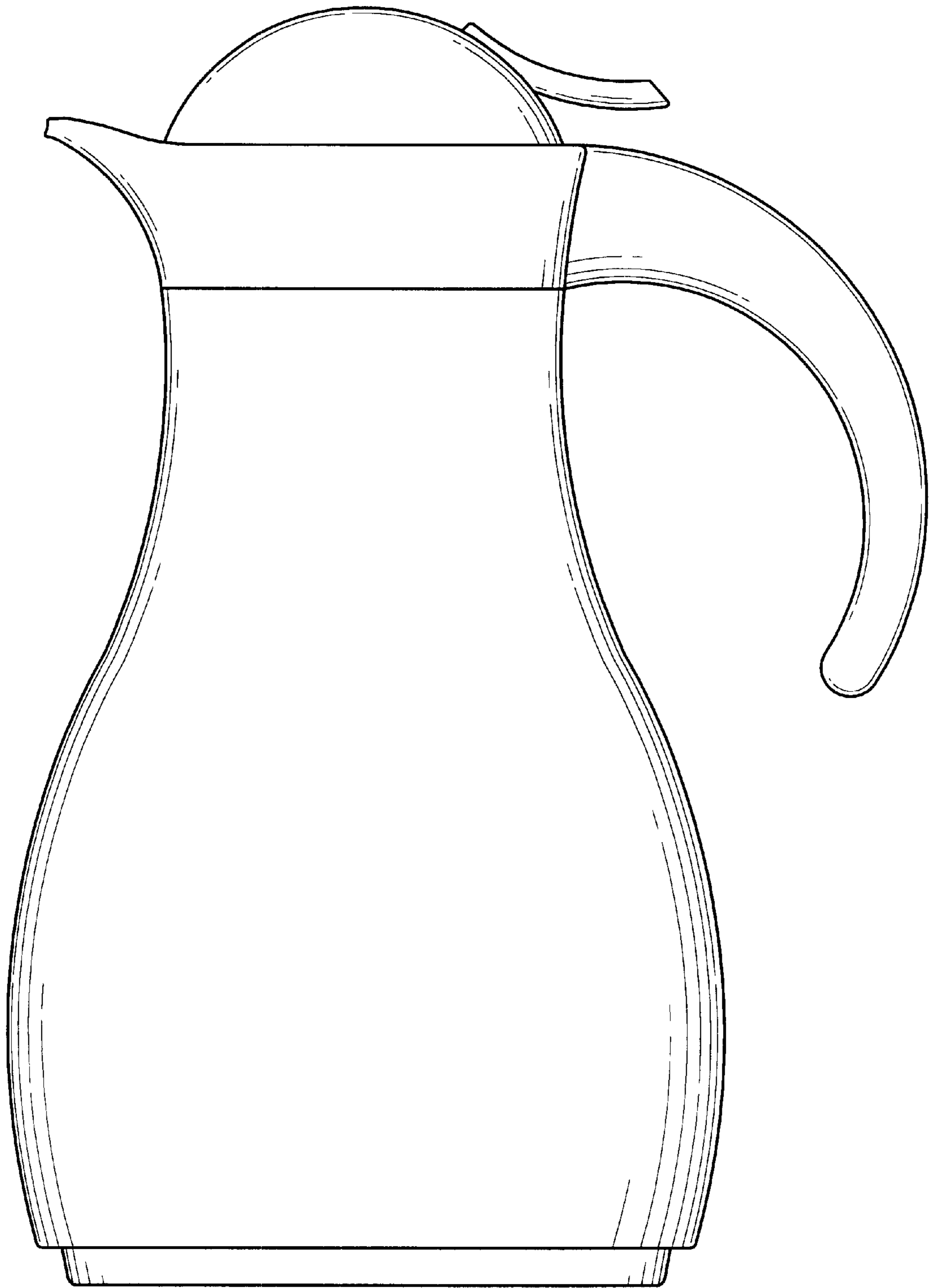

Fig. 10

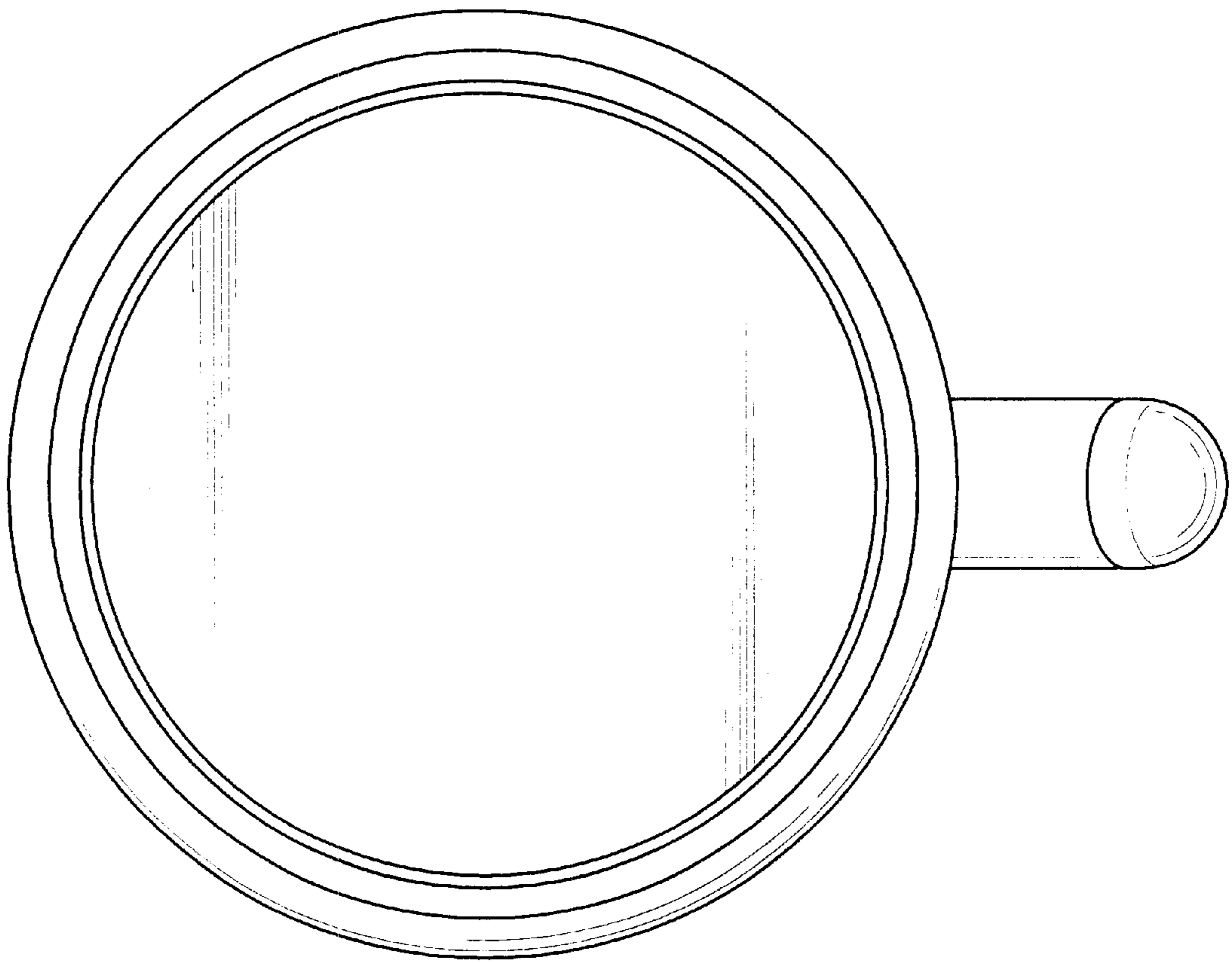

Fig. 11

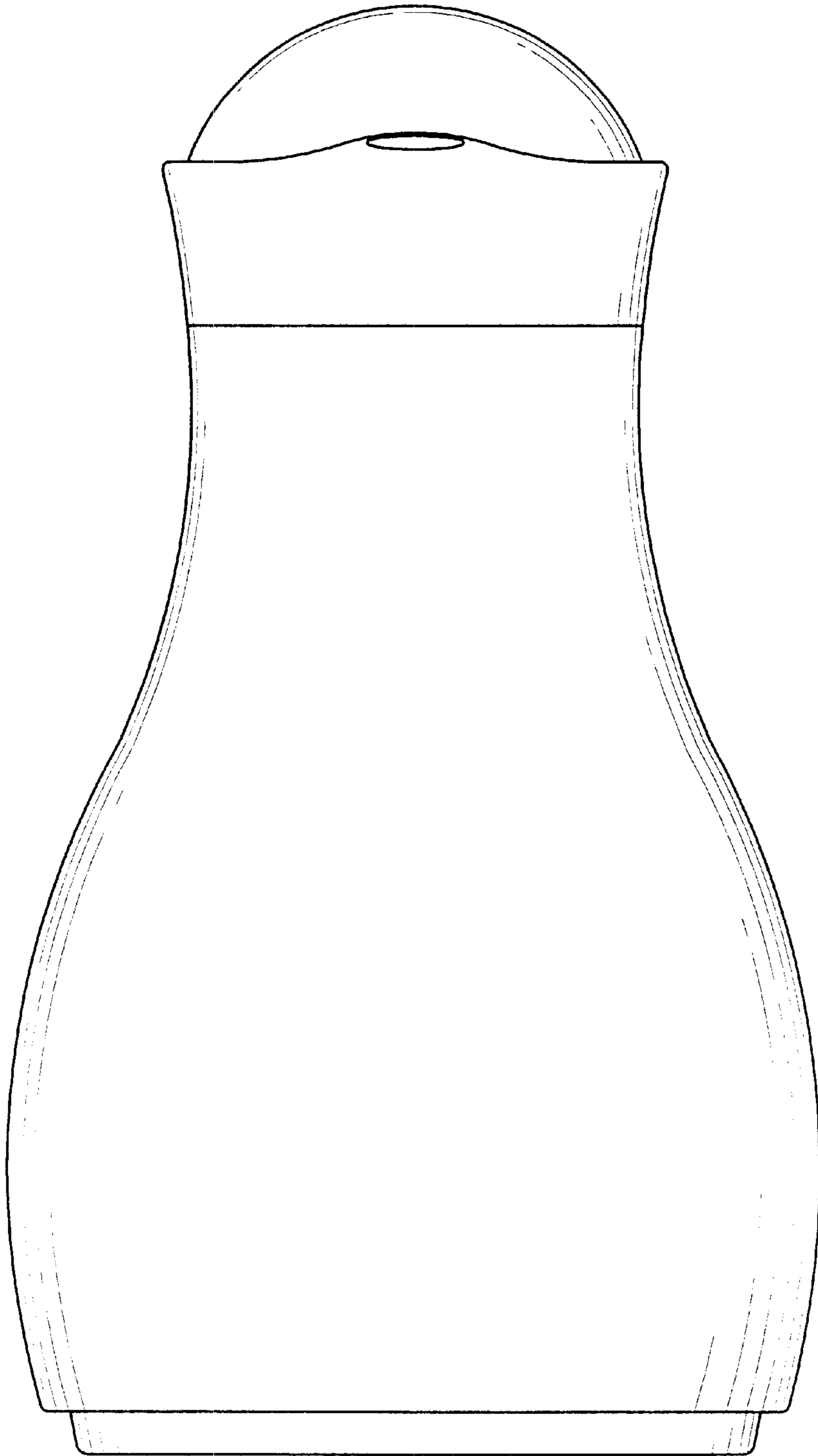

Fig. 12