



US00D453276S

(12) **United States Design Patent**
Stravitz

(10) **Patent No.:** **US D453,276 S**

(45) **Date of Patent:** **** Feb. 5, 2002**

(54) **RACK**

(76) **Inventor:** **David M. Stravitz**, 16 Park Ave. -
Suite 14A, New York, NY (US) 10016

(**) **Term:** **14 Years**

(21) **Appl. No.:** **29/128,033**

(22) **Filed:** **Aug. 16, 2000**

(51) **LOC (7) Cl.** **06-04**

(52) **U.S. Cl.** **D6/571**

(58) **Field of Search** D6/512, 553, 567,
D6/569, 570, 571; D19/75, 86, 90, 91;
D3/304; 206/214, 349; 211/13.1, 10, 11,
12, 44, 49.1, 52, 55, 69.1, 75, 86.01, 87.01,
88.01, 126.1

(56) **References Cited**

U.S. PATENT DOCUMENTS

3,874,758 A * 4/1975 Isaacs D19/90 X
D355,555 S * 2/1995 Ryan D6/569
D358,049 S * 5/1995 Wilson D6/567 X

D381,362 S * 7/1997 Meyer D19/90
D383,633 S * 9/1997 Schweitzer D6/567
D390,268 S * 2/1998 Stravitz D19/90
D411,399 S * 6/1999 Stravitz D6/567

* cited by examiner

Primary Examiner—Brian N. Vinson

(74) *Attorney, Agent, or Firm*—Frishauf, Holtz, Goodman,
Langer & Chick, P.C.

(57) **CLAIM**

The ornamental design for a rack, as shown and described.

DESCRIPTION

FIG. 1 is a top, front, right-side perspective view of a rack showing my new design;
FIG. 2 is a front elevational view thereof;
FIG. 3 is a left-side elevational view, the right side elevational view being a mirror image thereof;
FIG. 4 is a rear elevational view thereof;
FIG. 5 is a top plan view thereof; and,
FIG. 6 is a bottom view thereof.

1 Claim, 2 Drawing Sheets

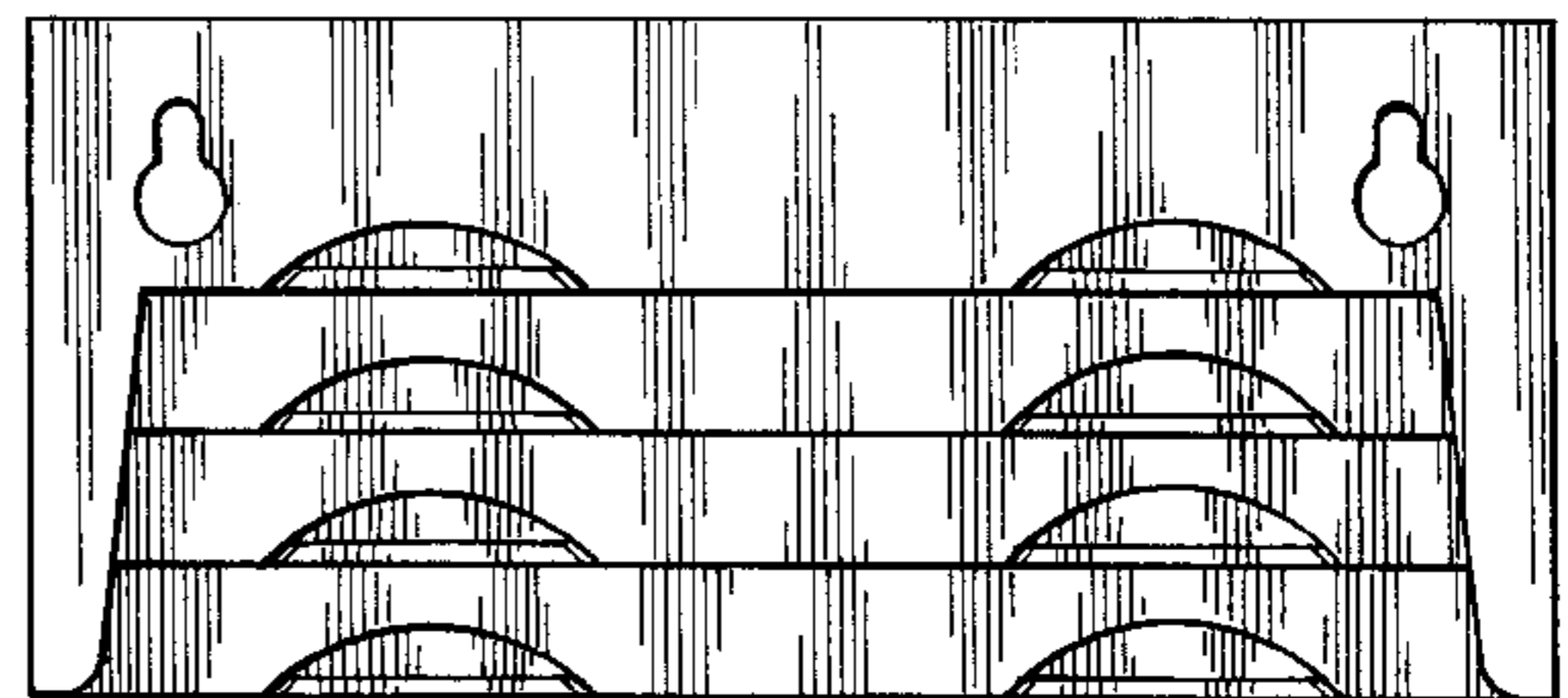
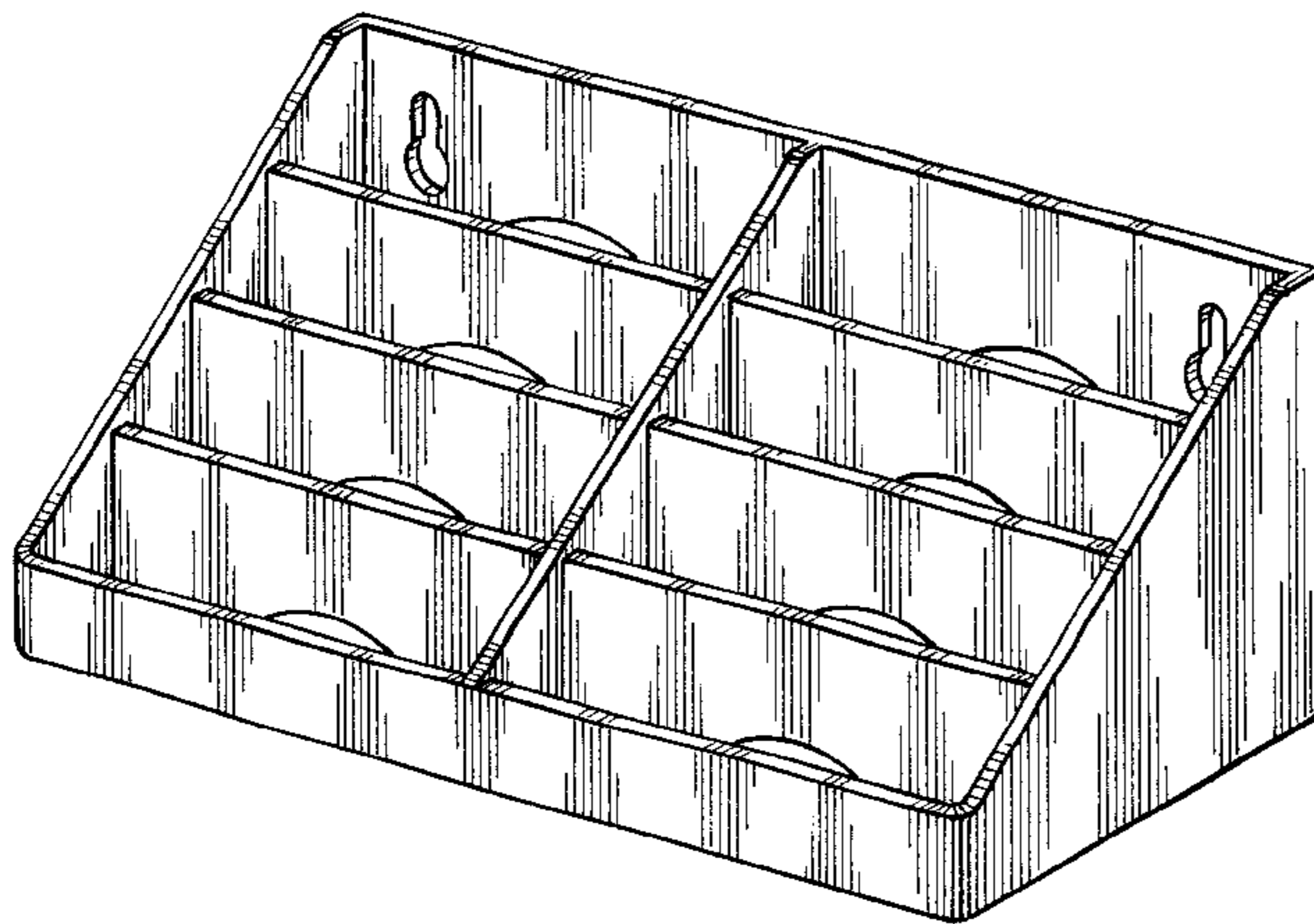

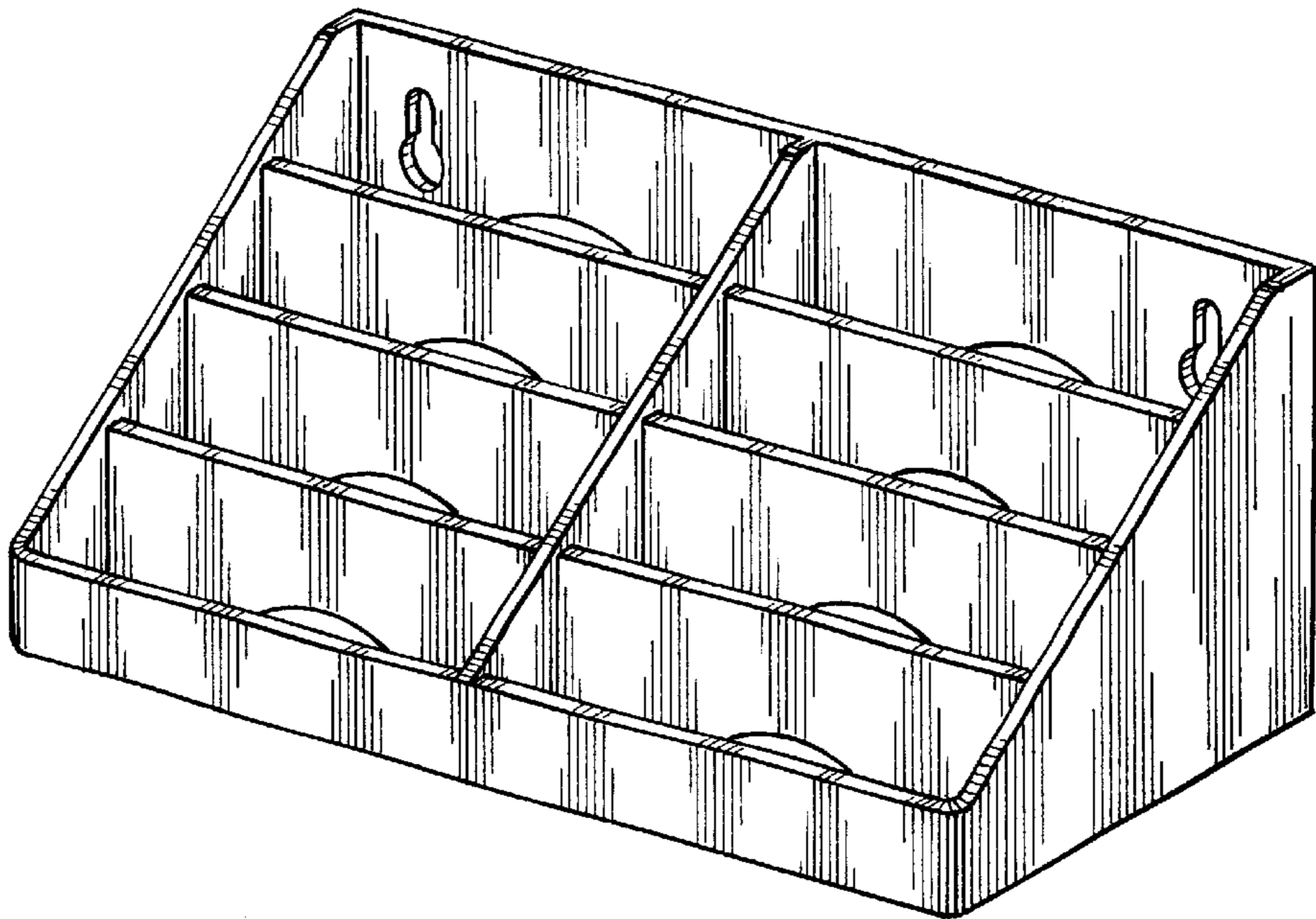

Fig. 1

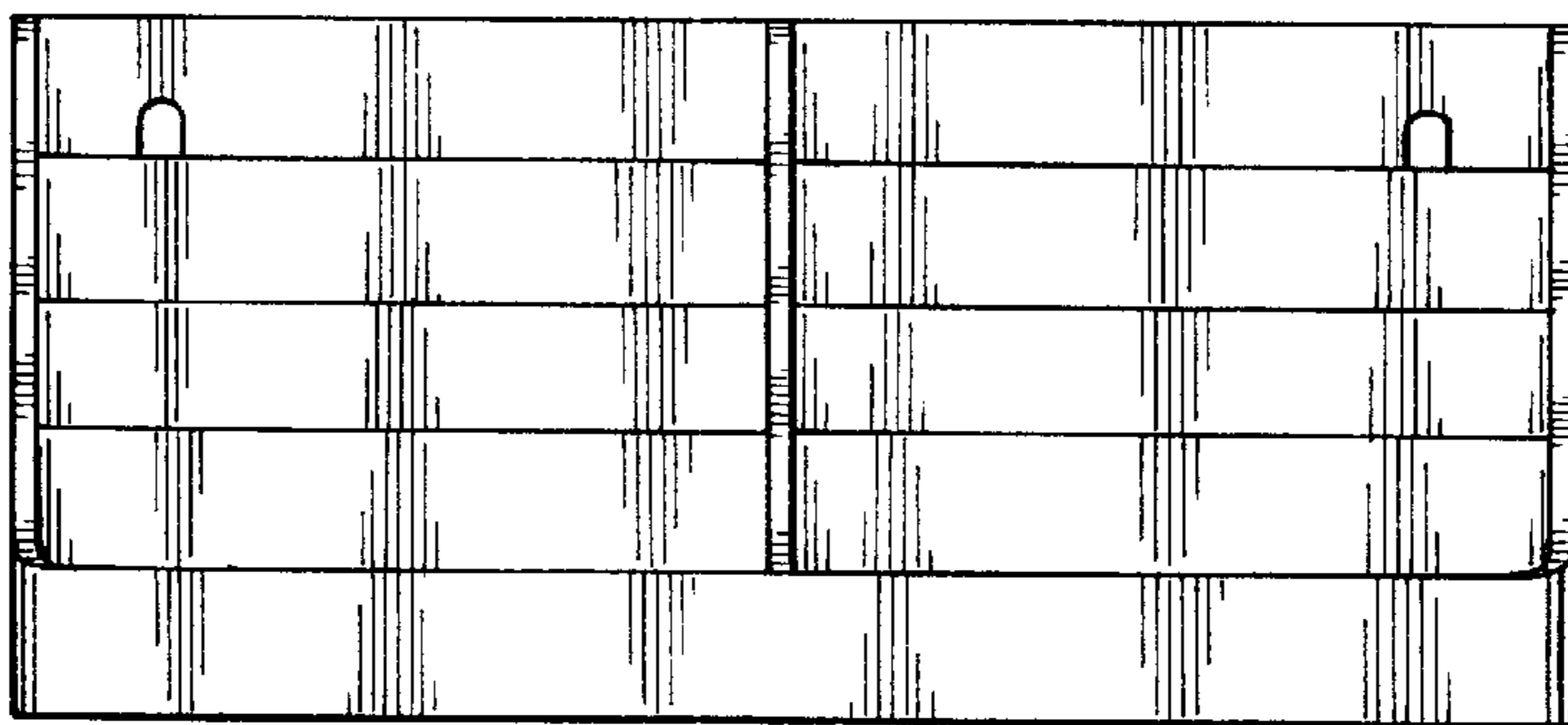

Fig. 2

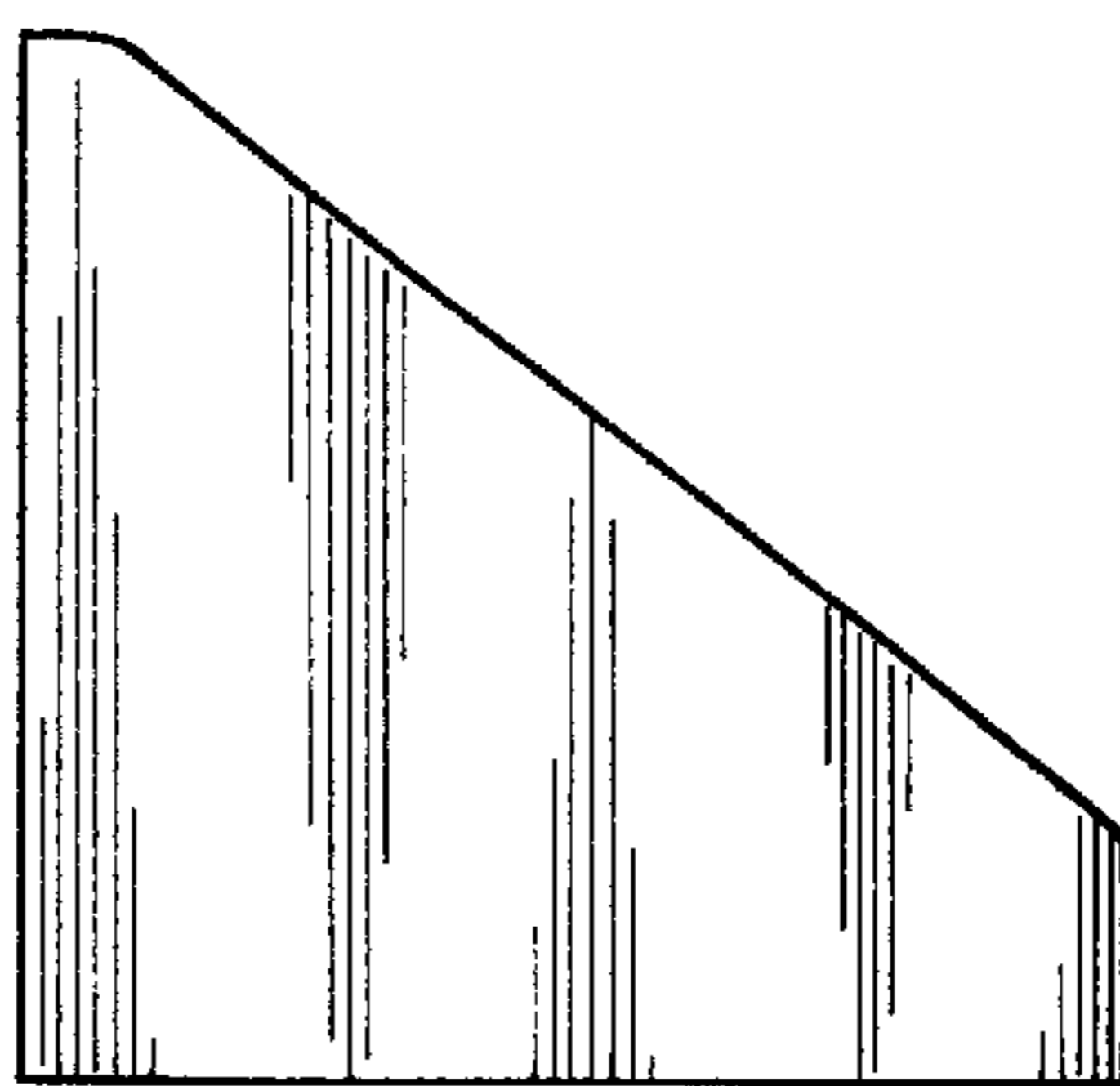

Fig. 3

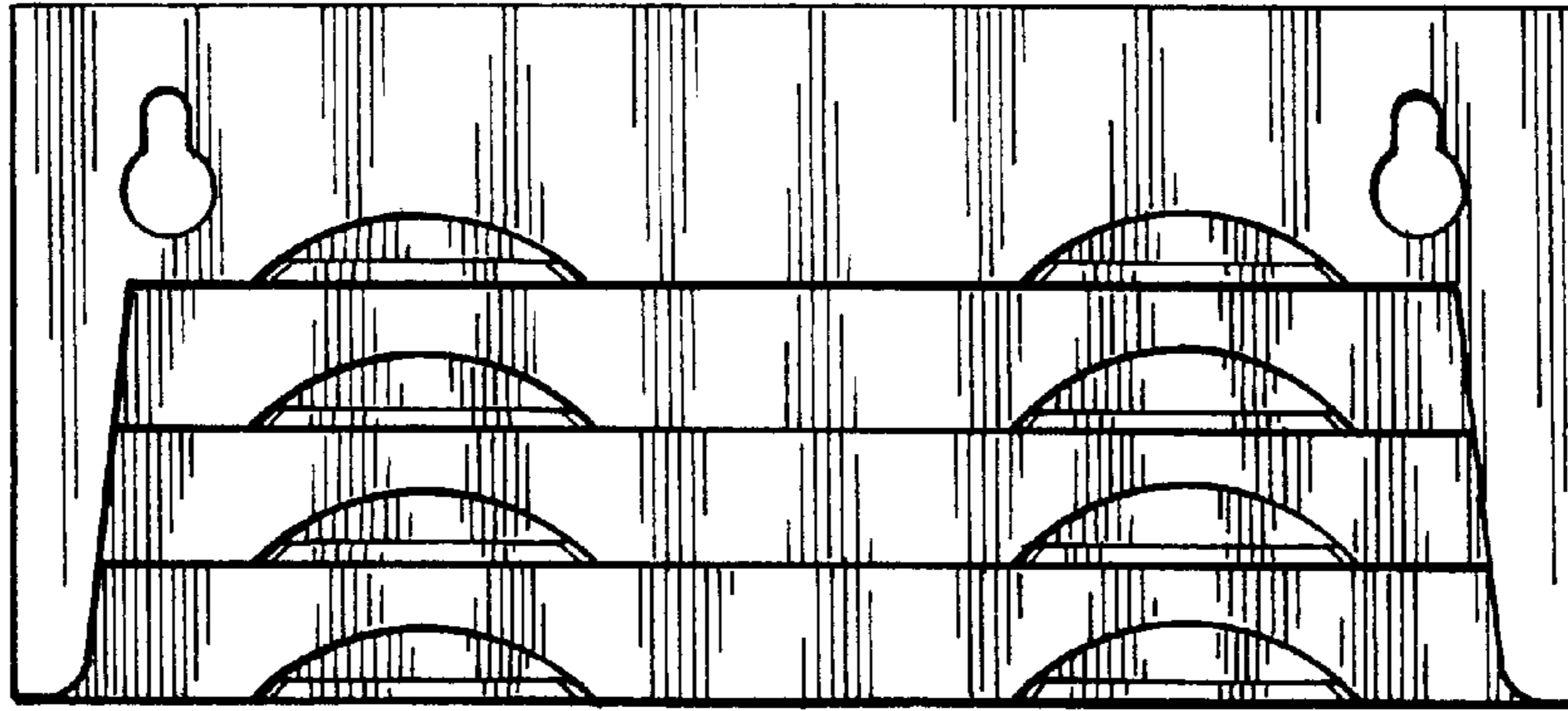

Fig. 4

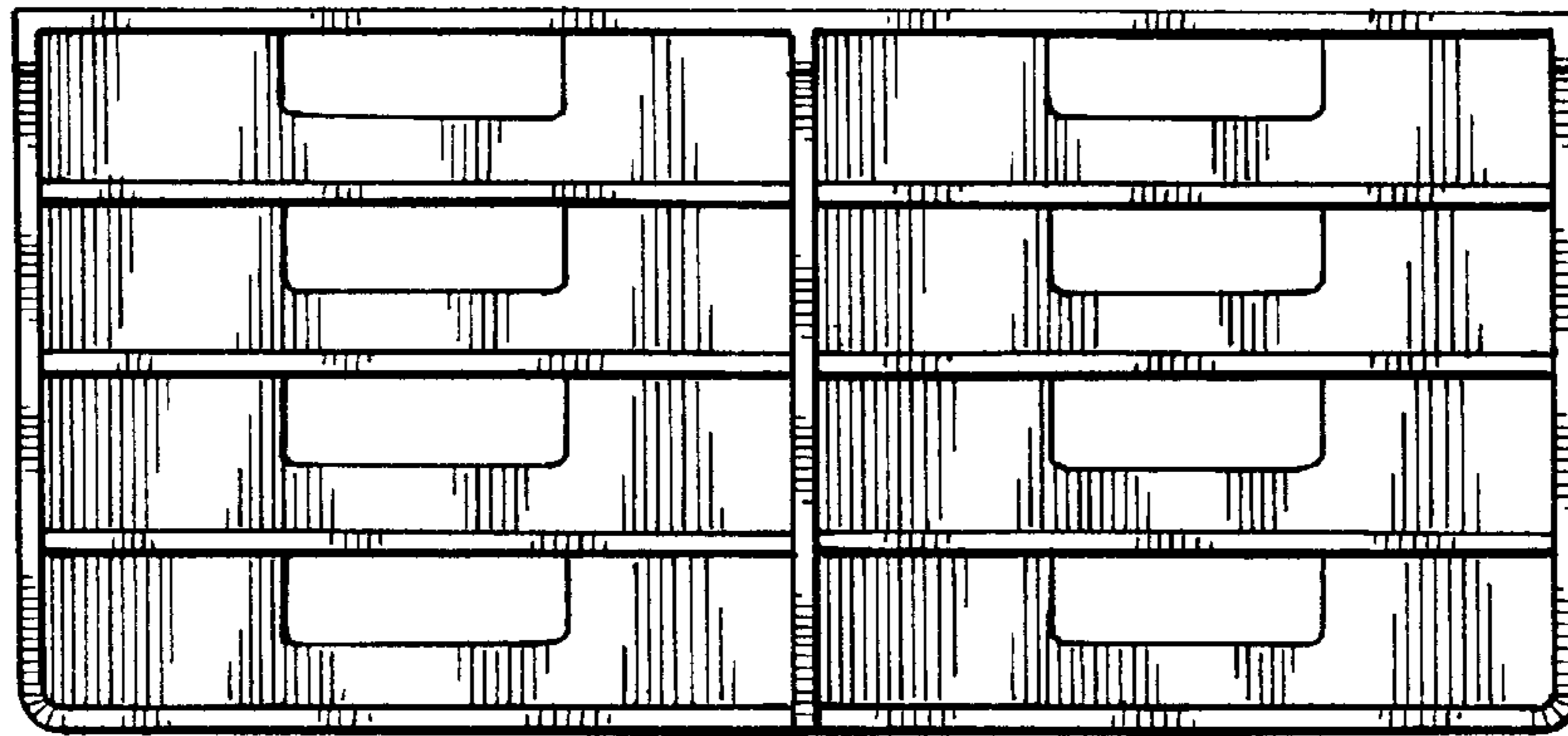

Fig. 5

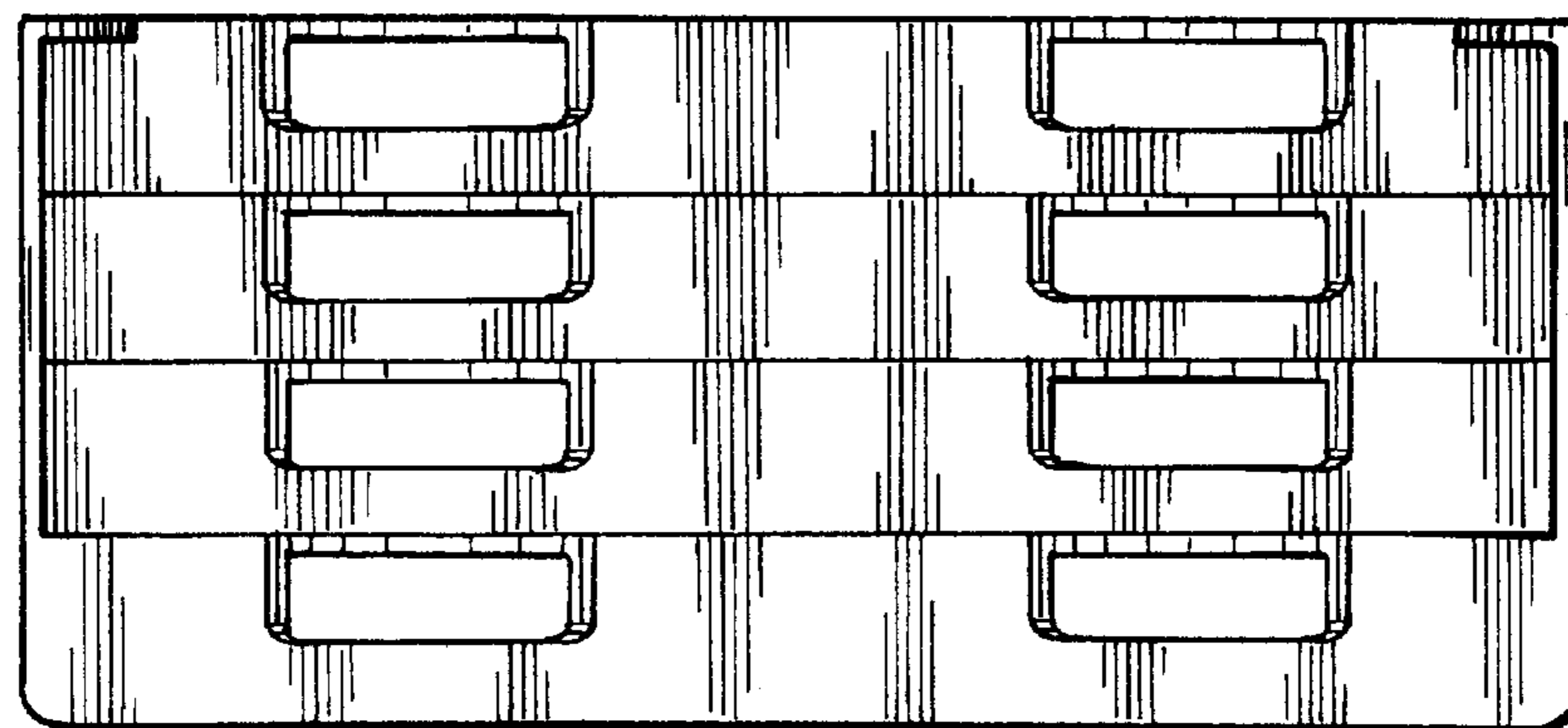

Fig. 6