



US00D453156S

(12) **United States Design Patent**
Le Thellec

(10) **Patent No.:** **US D453,156 S**
(45) **Date of Patent:** **** Jan. 29, 2002**

(54) **CAR RADIO COVER**

(75) Inventor: **Jean-Luc Le Thellec**, Gambais (FR)

(73) Assignee: **Mannesmann VDO AG** (DE)

(**) Term: **14 Years**

(21) Appl. No.: **29/129,496**

(22) Filed: **Sep. 12, 2000**

(30) **Foreign Application Priority Data**

Apr. 27, 2000 (DE) 400 04 180

(51) **LOC (7) Cl.** **14-03**

(52) **U.S. Cl.** **D14/258**

(58) **Field of Search** D14/135, 136,
D14/156, 157, 162, 164, 168, 188, 197-198,
257-258; 369/75.1, 75.2, 77.1, 77.2; 455/344,
347, 350, 351

(56) **References Cited**

U.S. PATENT DOCUMENTS

| | | | | | |
|-------------|---|---------|------------------|-------|----------|
| D313,023 S | * | 12/1990 | Kolenda et al. | | D14/258 |
| D368,714 S | * | 4/1996 | Ito et al. | | D14/164 |
| D372,713 S | * | 8/1996 | Starck | | D14/135 |
| D400,529 S | * | 11/1998 | Kakizaki | | D14/157 |
| 5,848,042 A | * | 12/1998 | Takahashi | | 369/75.1 |
| D407,394 S | * | 3/1999 | Oh | | D14/135 |
| D430,123 S | * | 8/2000 | Shinohara et al. | | D14/135 |

* cited by examiner

Primary Examiner—Nanda Bondade
(74) *Attorney, Agent, or Firm*—Richard A. Speer; Mayer, Brown & Platt

(57) **CLAIM**

The ornamental design for a car radio cover, as shown and described.

DESCRIPTION

FIG. 1 is an isometric view showing my new design;
FIG. 2 is a top plan view thereof;
FIG. 3 is a front elevational view thereof;
FIG. 4 is a left side elevational view thereof;
FIG. 5 is a right side elevational view thereof;
FIG. 6 is an isometric view of a second embodiment of FIG. 1;
FIG. 7 is a top plan view thereof;
FIG. 8 is a front elevational view thereof;
FIG. 9 is a left side elevational view thereof;
FIG. 10 is a right side elevational view thereof;
FIG. 11 is an isometric view of a third embodiment of FIG. 1;
FIG. 12 is a top plan view of a variation of my new design;
FIG. 13 is a front elevational view of a variation of my new design;
FIG. 14 is a right side elevational view of a variation of my new design; and,
FIG. 15 is a left side elevational view of a variation of my new design.

1 Claim, 3 Drawing Sheets

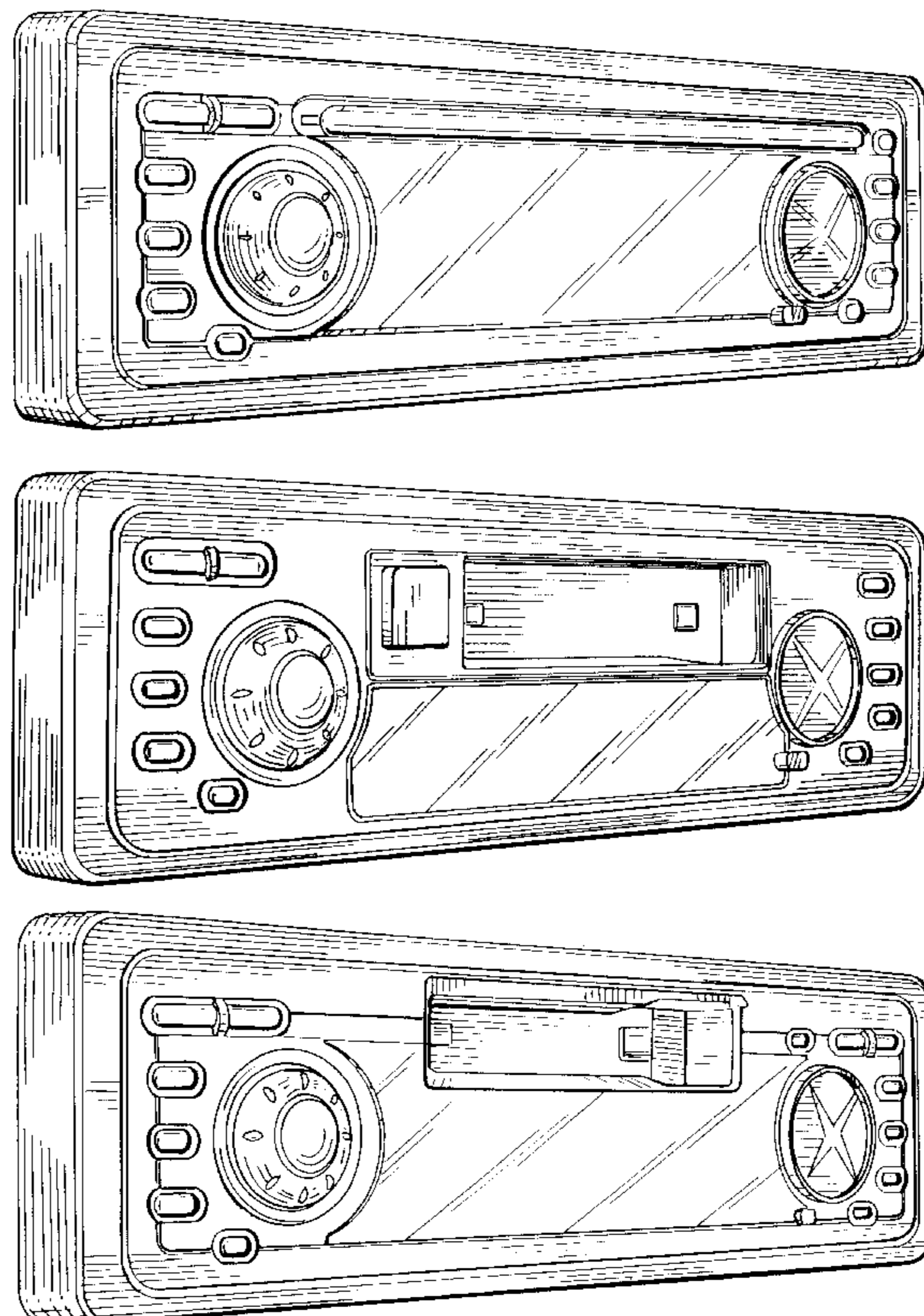

FIG. 1

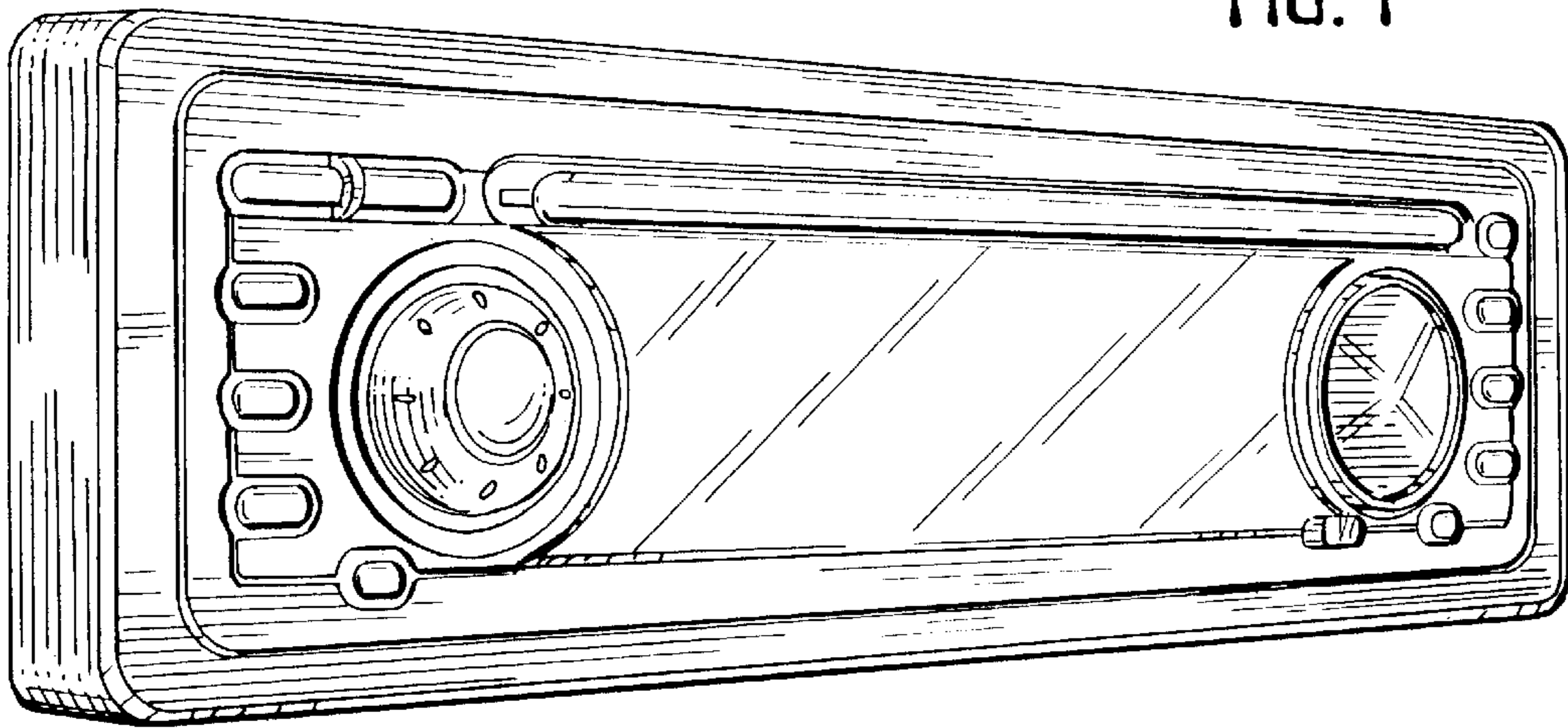

FIG. 2

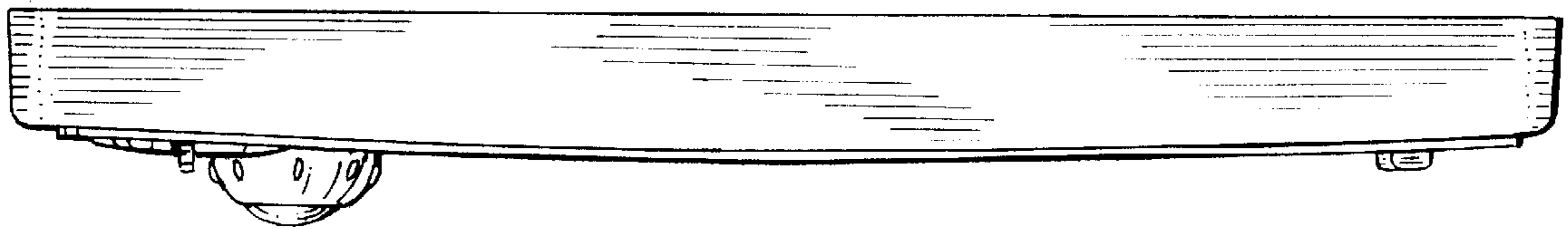

FIG. 3

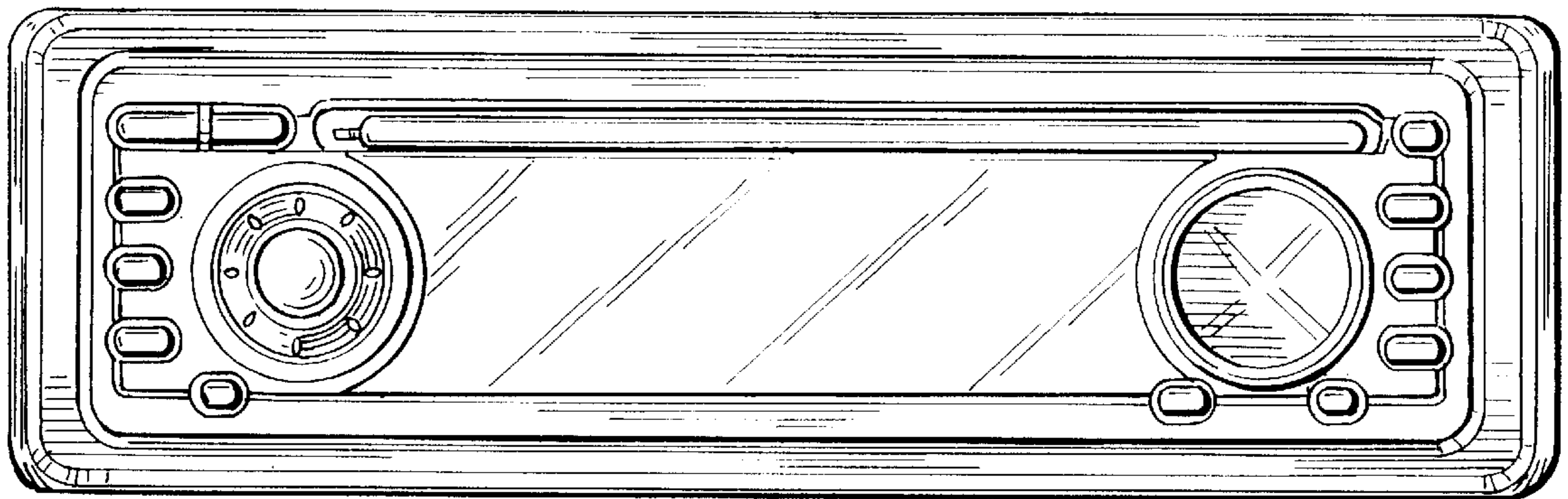

FIG. 4

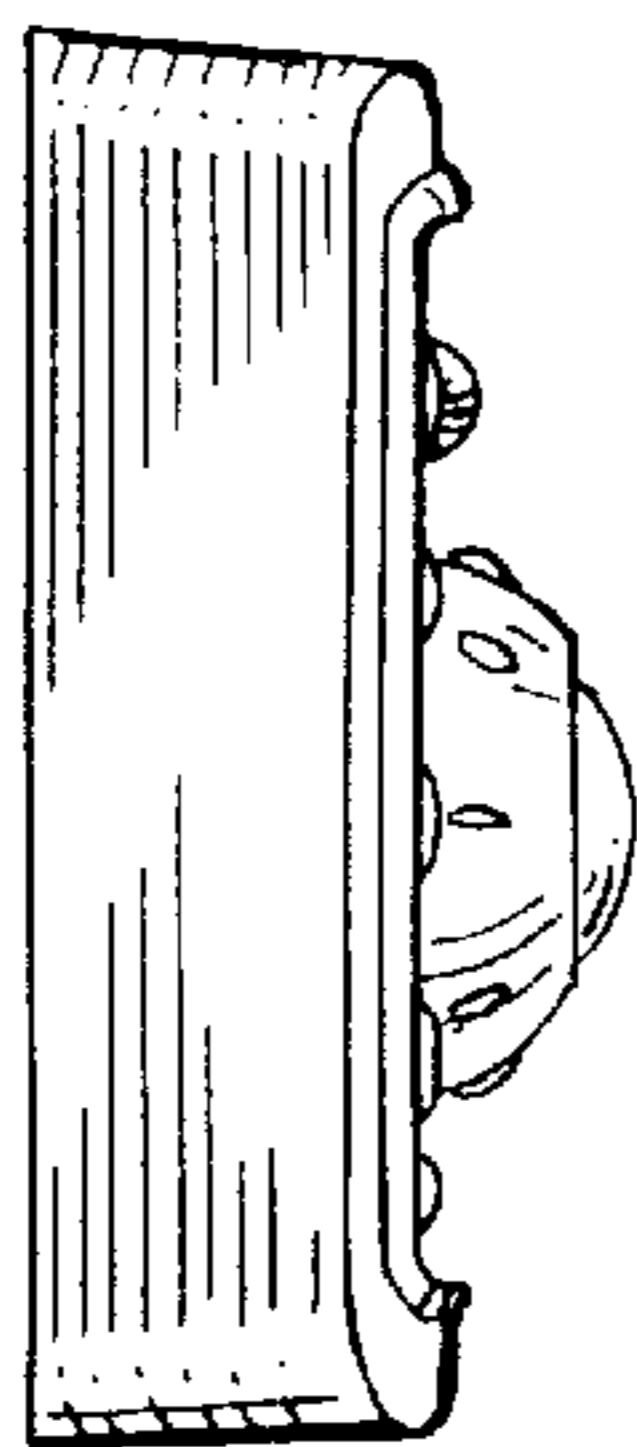

FIG. 5

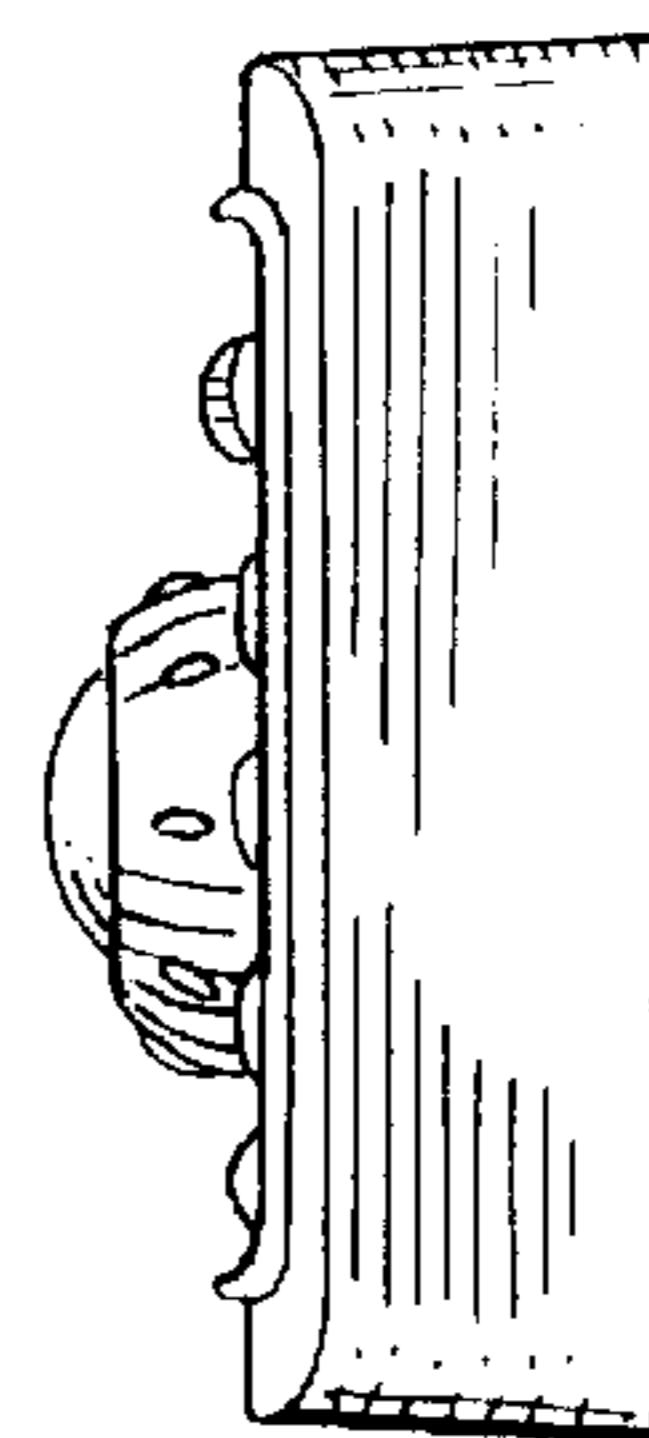

FIG. 6

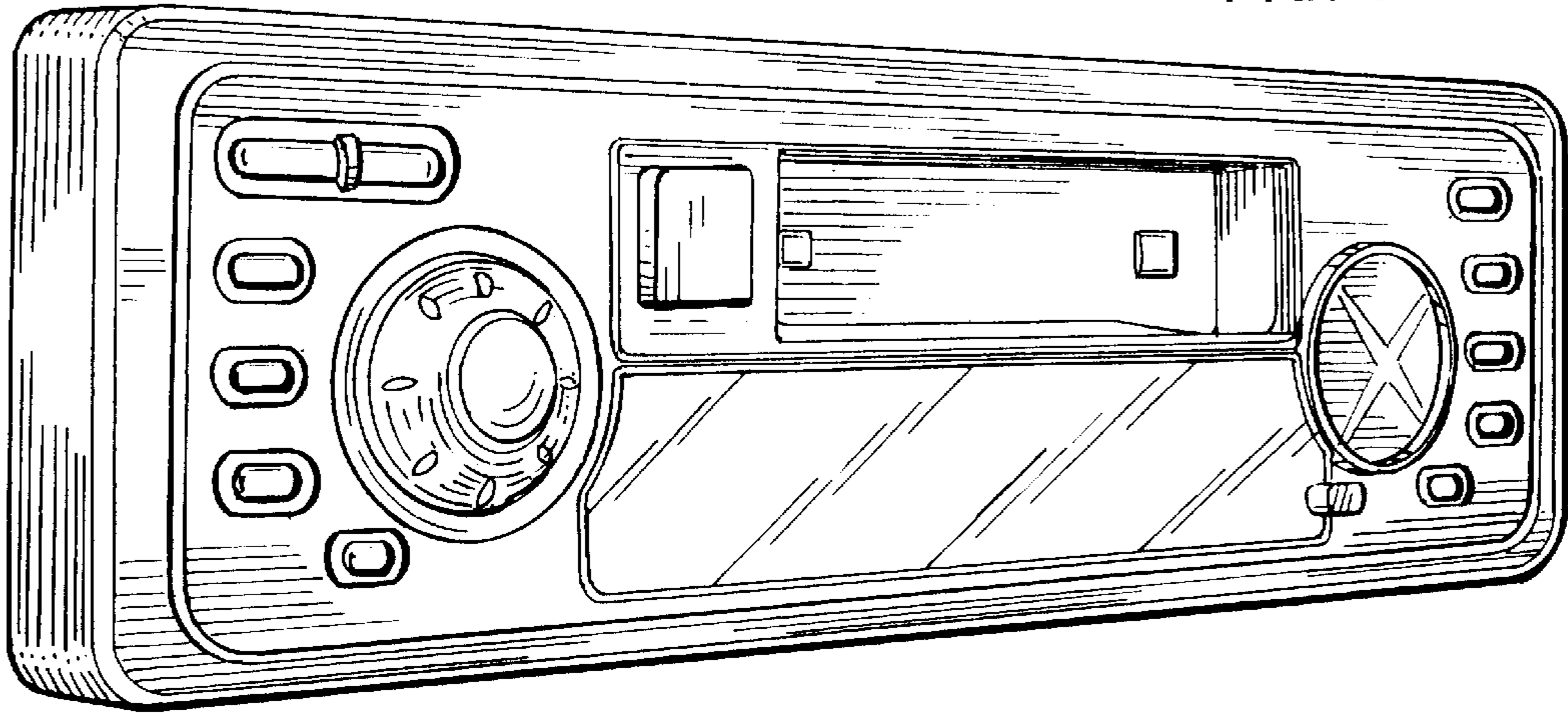

FIG. 7

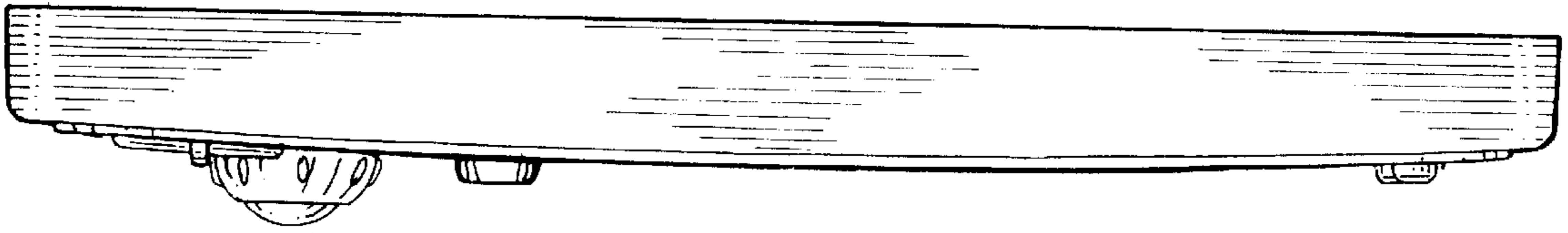

FIG. 8

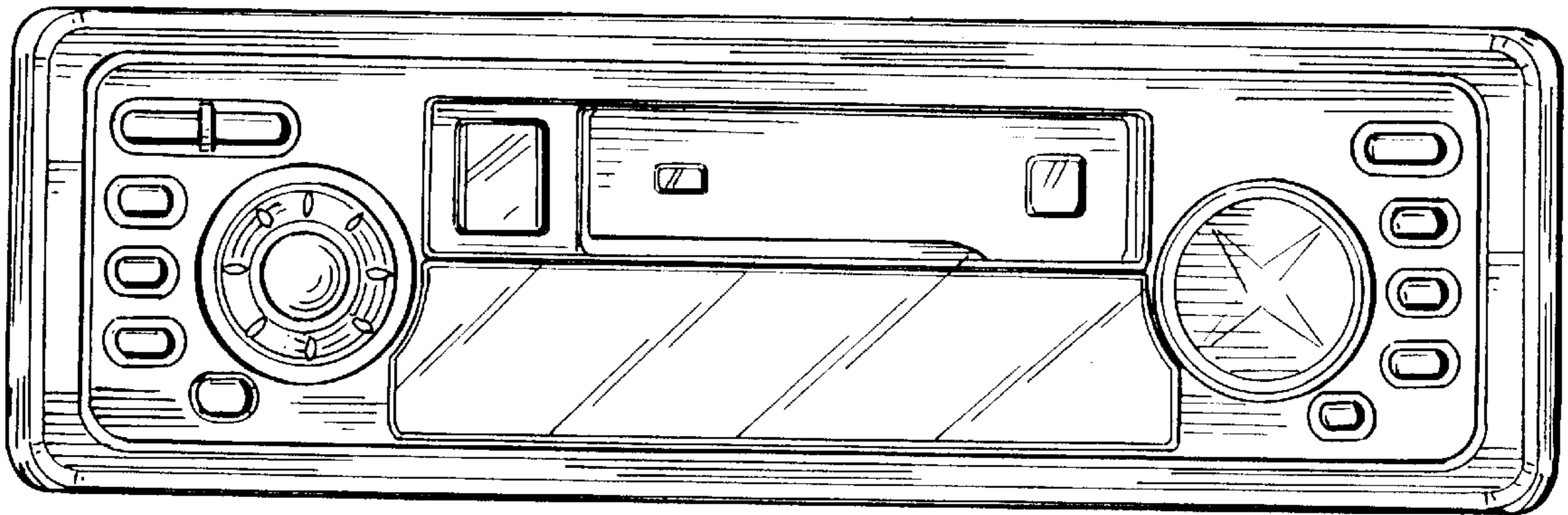

FIG. 9

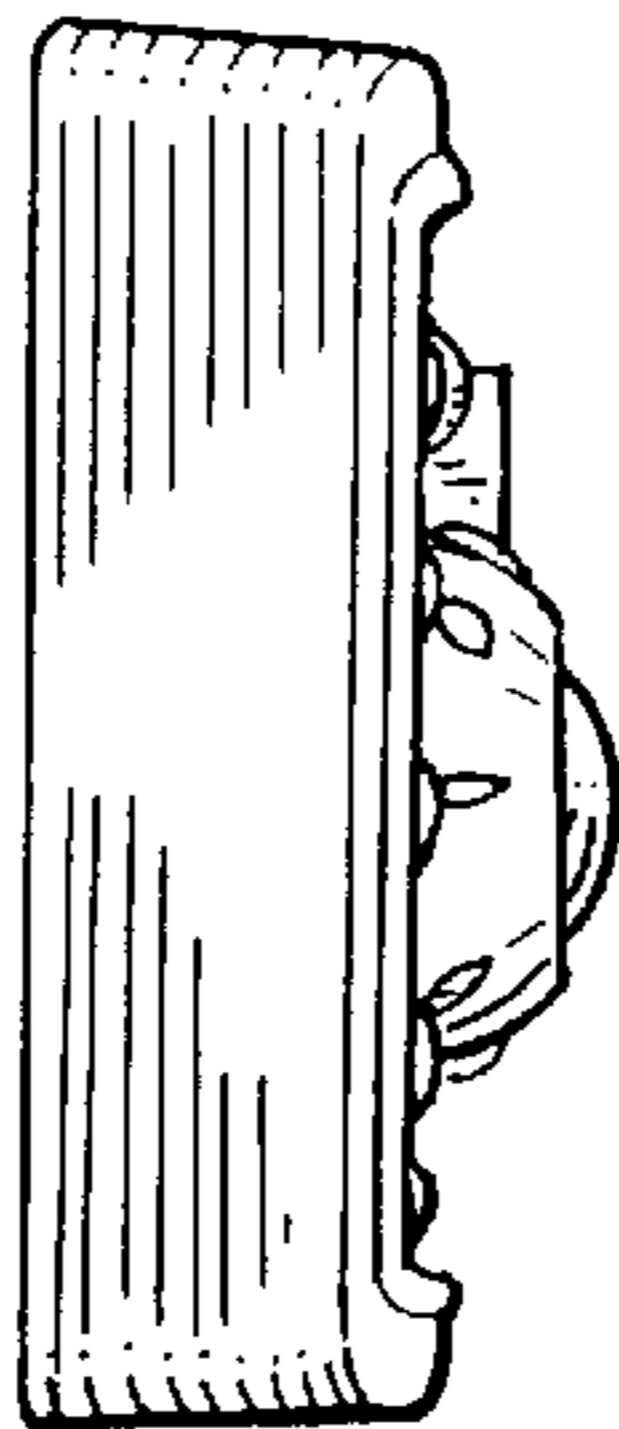
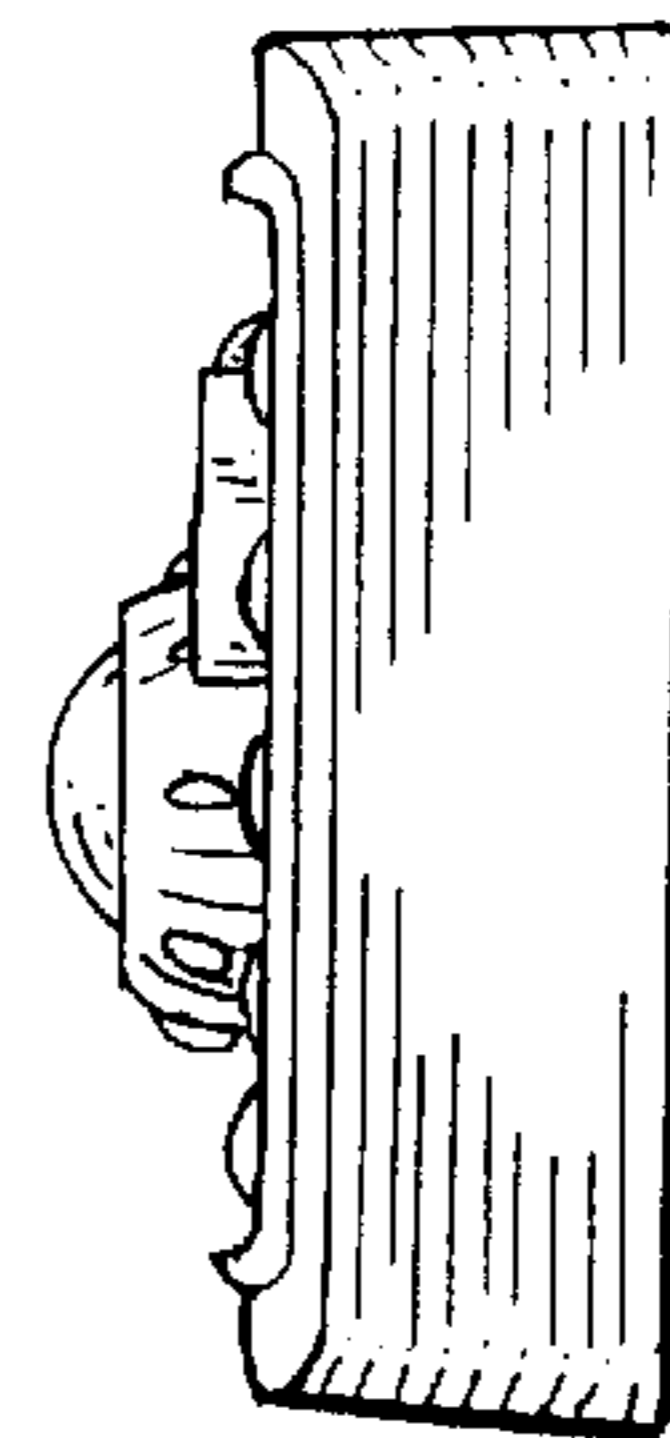

FIG. 10



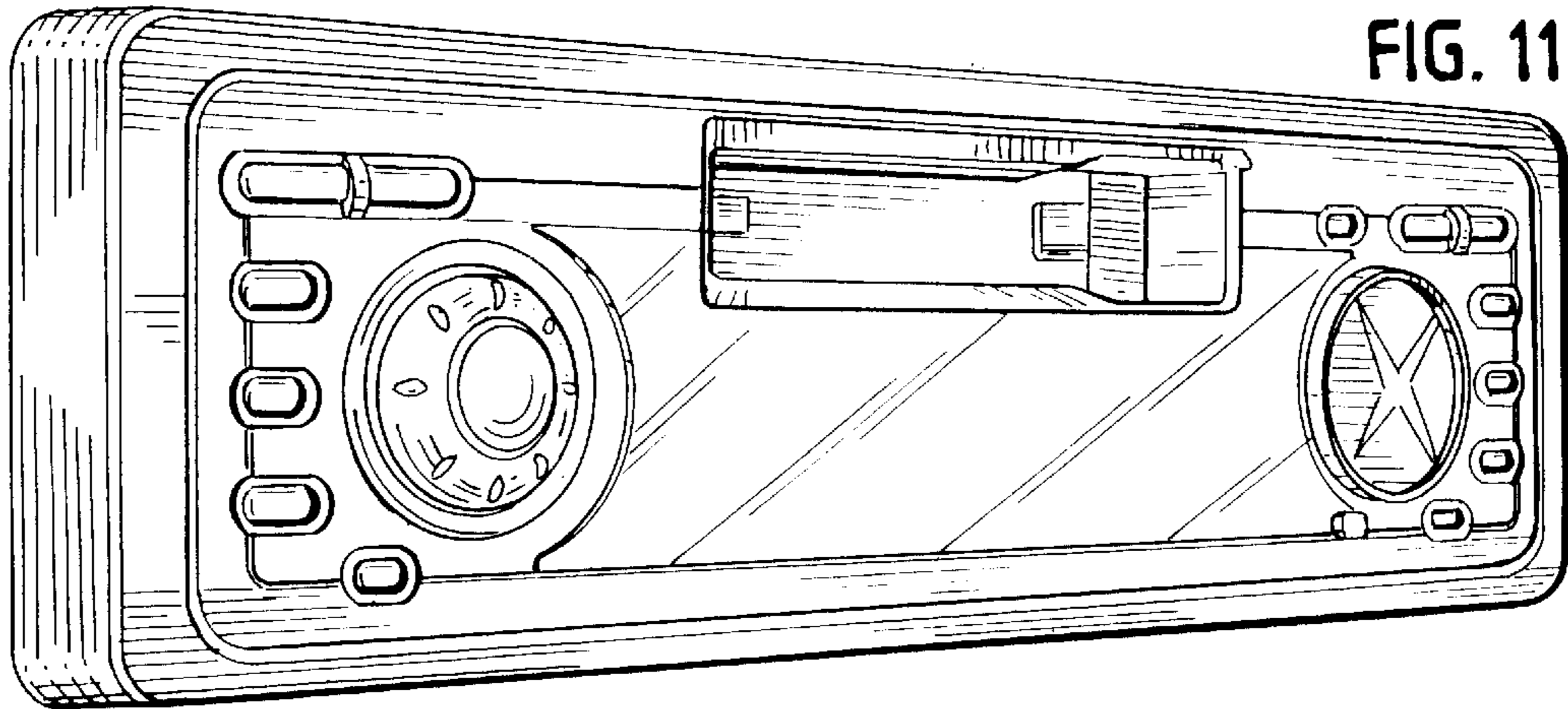

FIG. 11

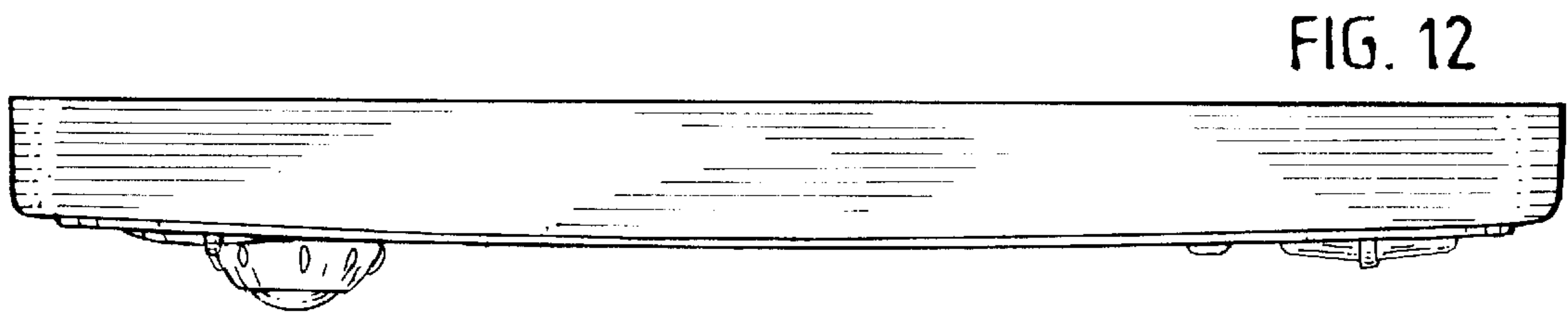

FIG. 12

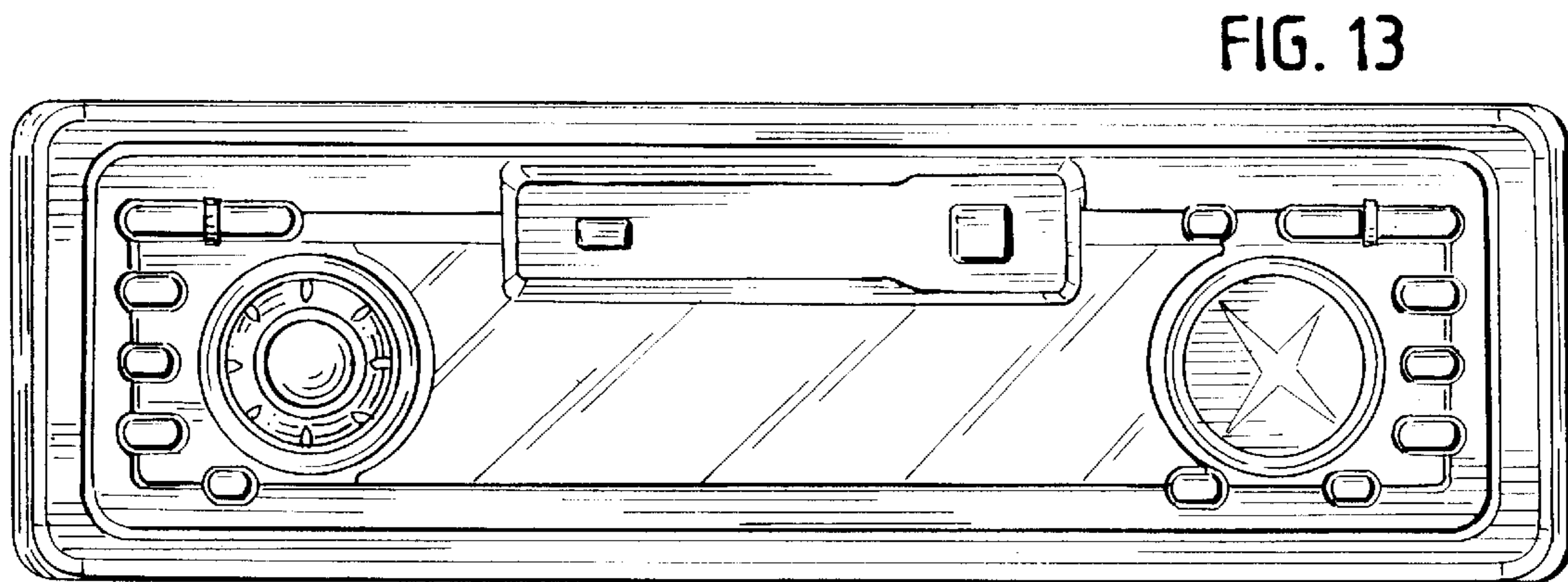

FIG. 13

FIG. 14



FIG. 15

