



US00D453048S

(12) **United States Design Patent**
Orozco

(10) **Patent No.:** **US D453,048 S**

(45) **Date of Patent:** **** Jan. 22, 2002**

(54) **LIGHT FIXTURE**

(75) **Inventor:** **Sergio J. Orozco**, West New York, NJ (US)

(73) **Assignee:** **Quoizel, Inc.**, Goose Creek, SC (US)

(**) **Term:** **14 Years**

(21) **Appl. No.:** **29/133,921**

(22) **Filed:** **Dec. 11, 2000**

(51) **LOC (7) Cl.** **26-05**

(52) **U.S. Cl.** **D26/87**

(58) **Field of Search** D26/87, 92, 155,
D26/142; 362/147, 432

(56) **References Cited**

PUBLICATIONS

Corbett Lighting catalog, 1994, p. 14, wall lamp # 1573.*
Quoizel Lighting catalog, 1990, p. 19, wall lamp #WM883Bw.*

Item Nos. K-6173 CH and K-6174 CH, Catalog p. 201, Kichler Lighting Catalog No. 198, 1998.

Item No. 6113 TGP, Catalog p. 407, Kichler Lighting Catalog No. 198, 1998.

* cited by examiner

Primary Examiner—Susan J. Lucas

(74) *Attorney, Agent, or Firm*—Nelson Mullins Riley & Scarborough

(57) **CLAIM**

The ornamental design for a light fixture, substantially as shown and described.

DESCRIPTION

FIG. 1 is a perspective view of a light fixture embodying the design of the present invention.

FIG. 2 is a front side elevational view of the light fixture illustrated in FIG. 1.

FIG. 3 is a back side elevational view of the light fixture illustrated in FIG. 1.

FIG. 4 is a left side elevational view of the light fixture illustrated in FIG. 1.

FIG. 5 is a top view of the light fixture illustrated in FIG. 1.

FIG. 6 is a right side elevational view of the light fixture illustrated in FIG. 1; and,

FIG. 7 is a bottom view of the light fixture shown in FIG. 1.

1 Claim, 7 Drawing Sheets

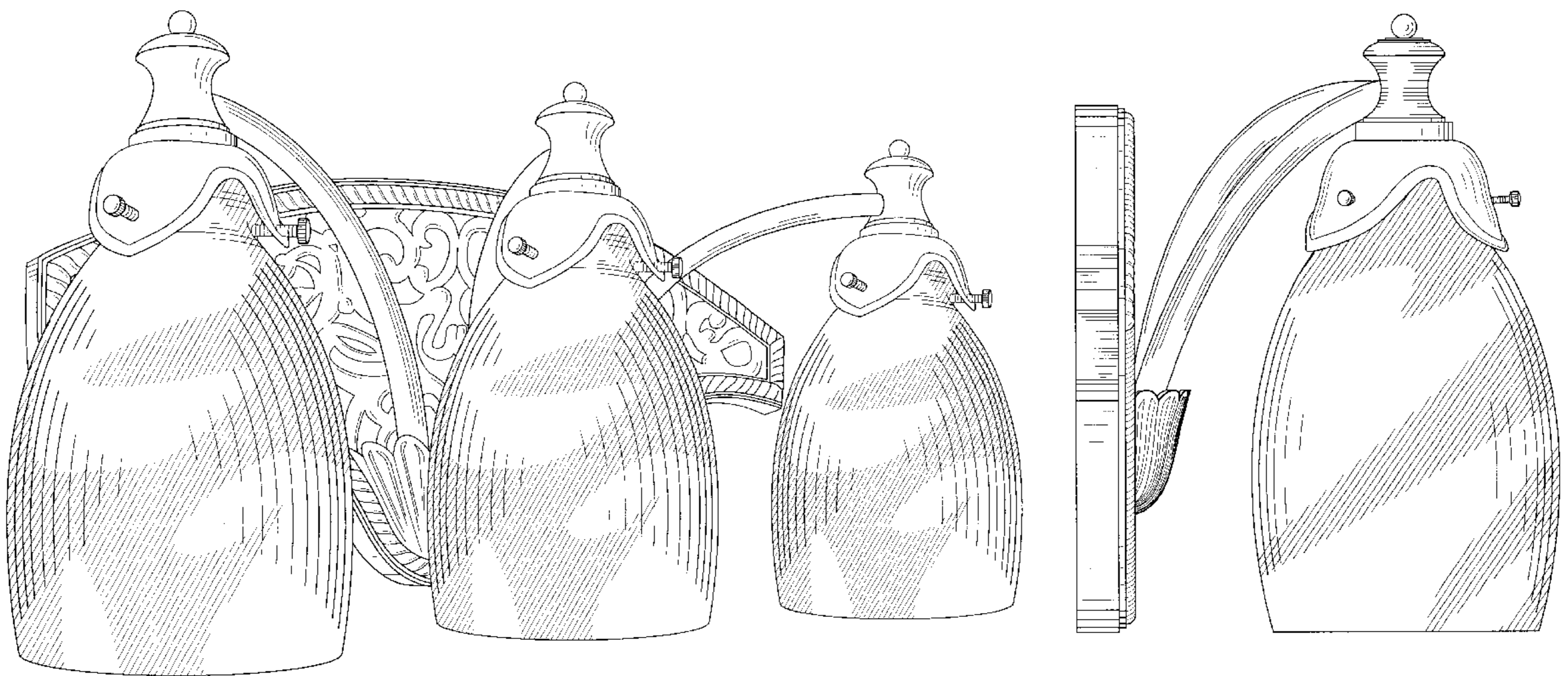

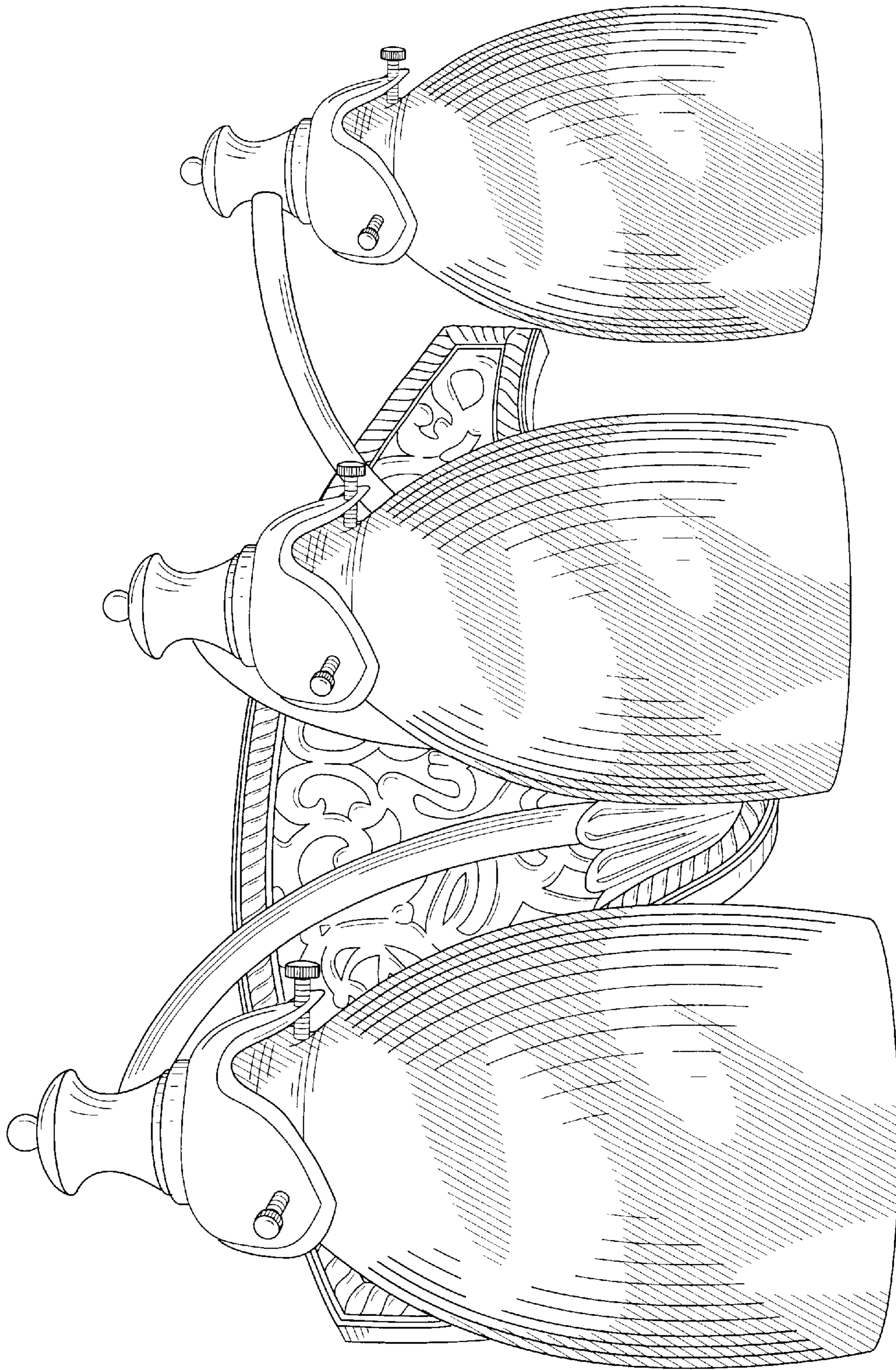

FIG. 1.

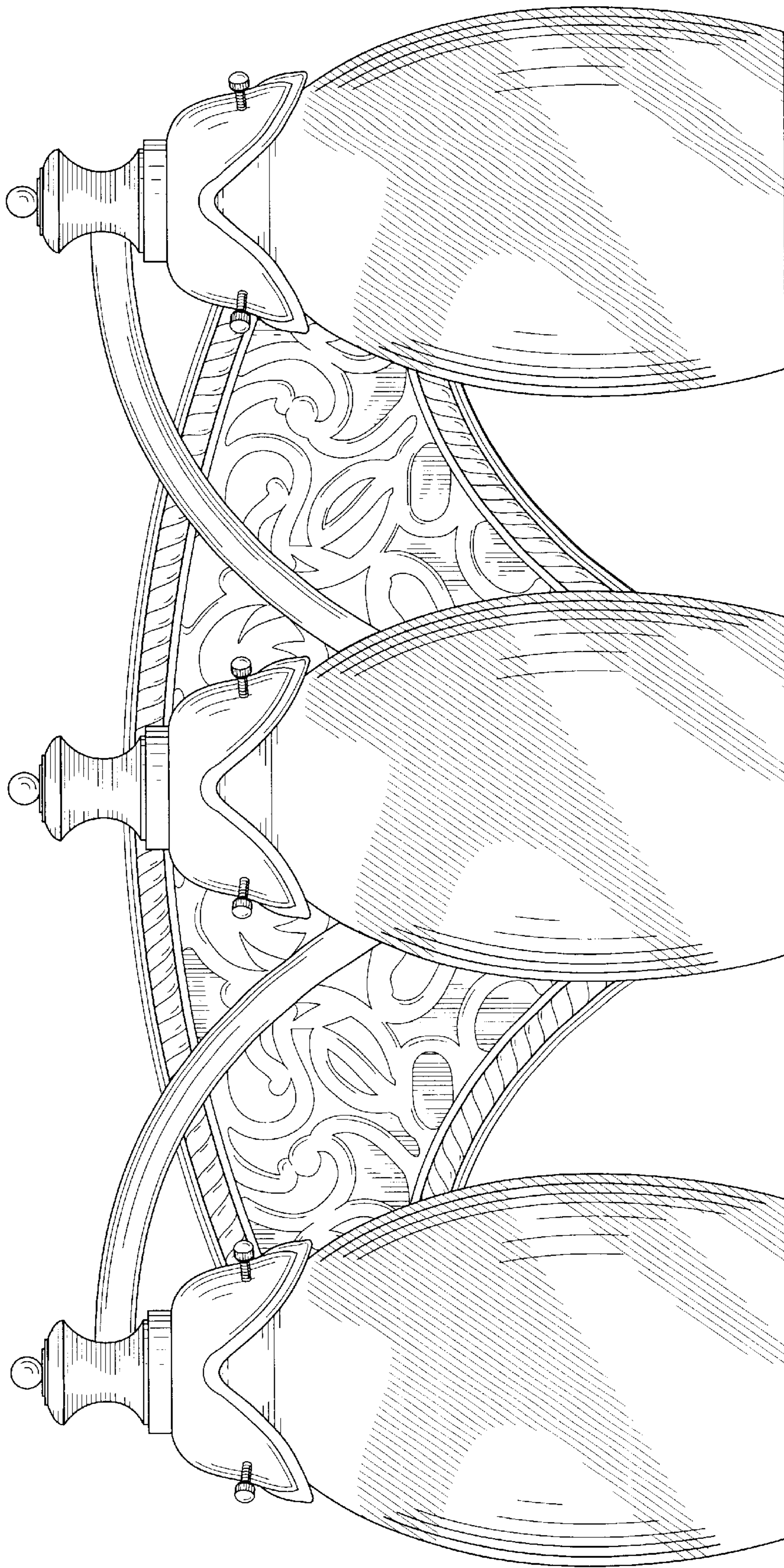

FIG. 2.

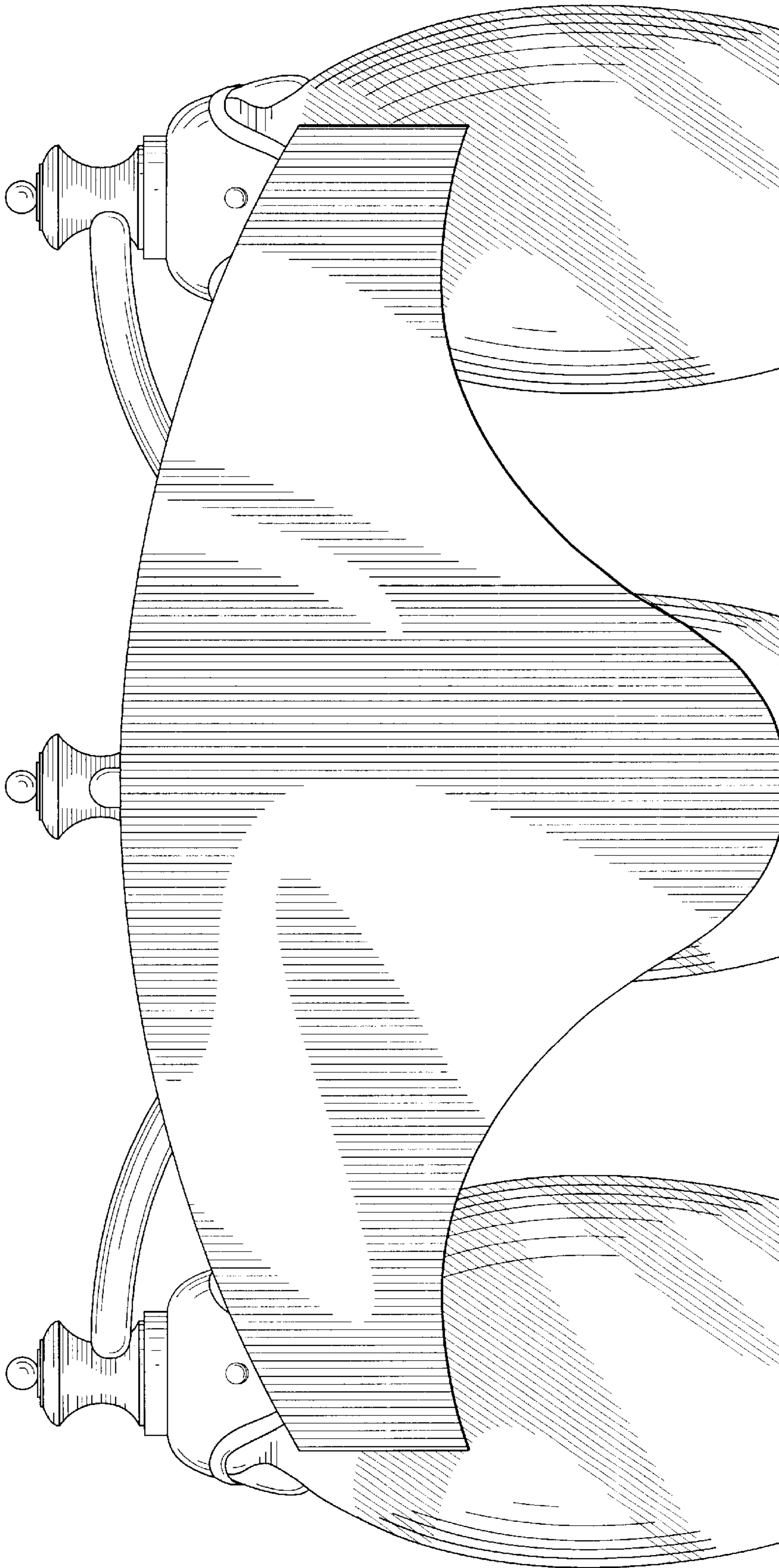

FIG. 3.

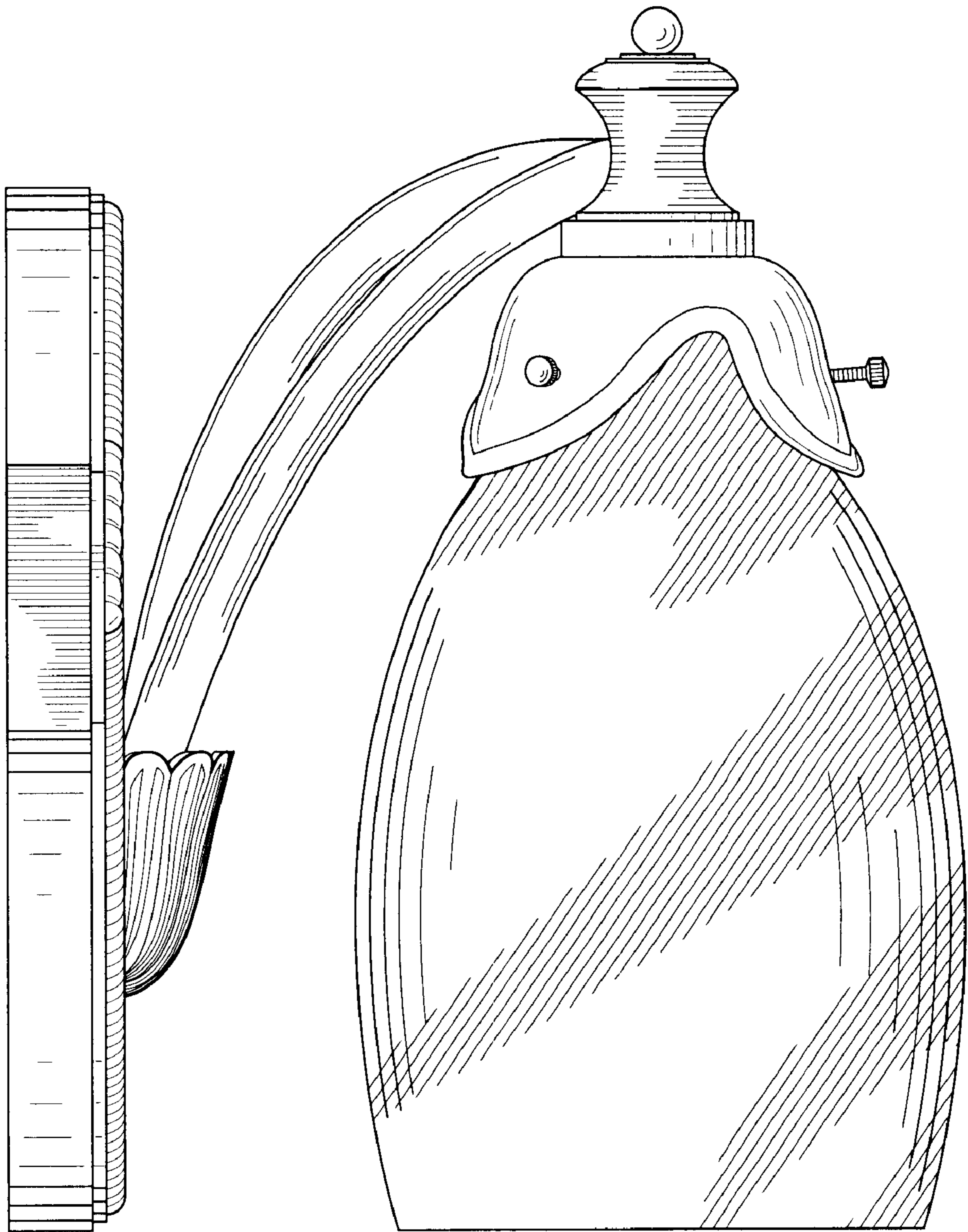

FIG. 4.

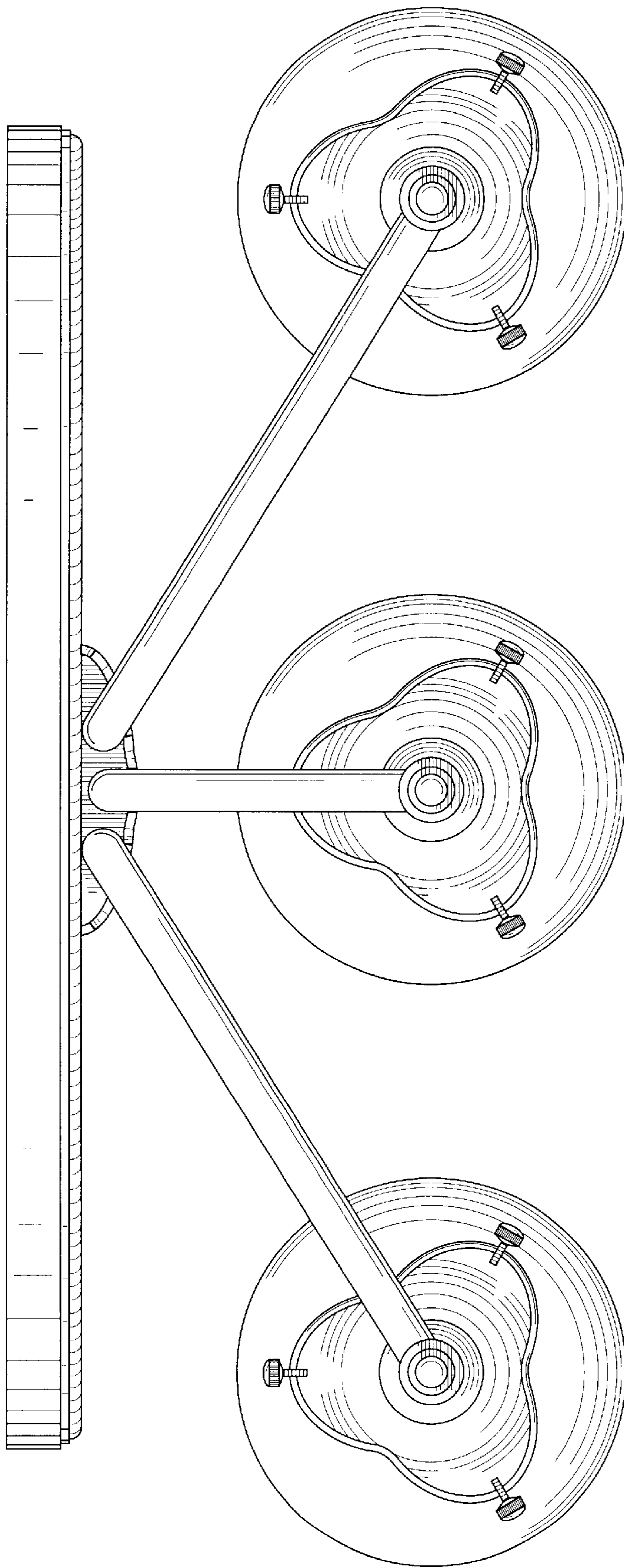

FIG. 5.

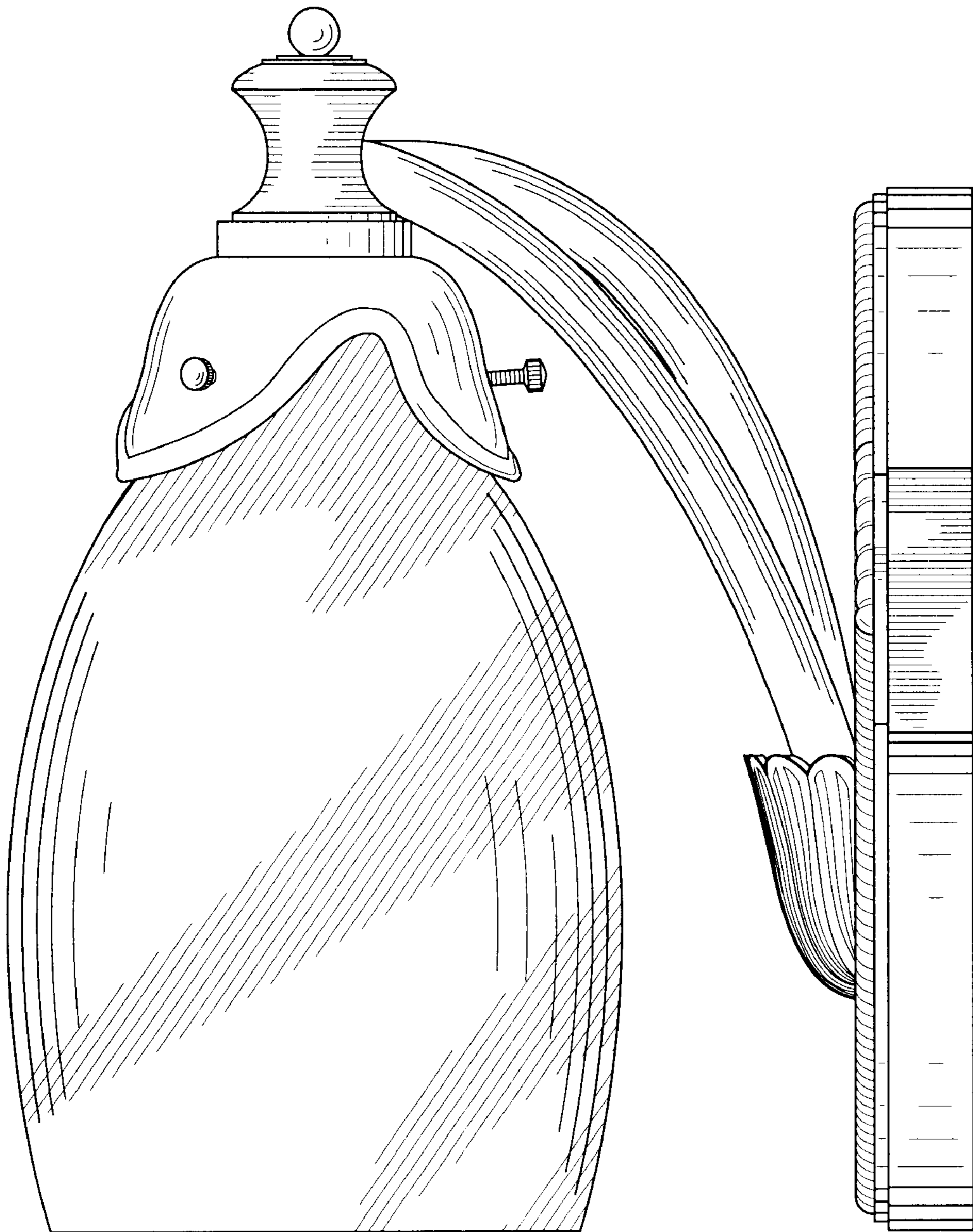

FIG. 6.

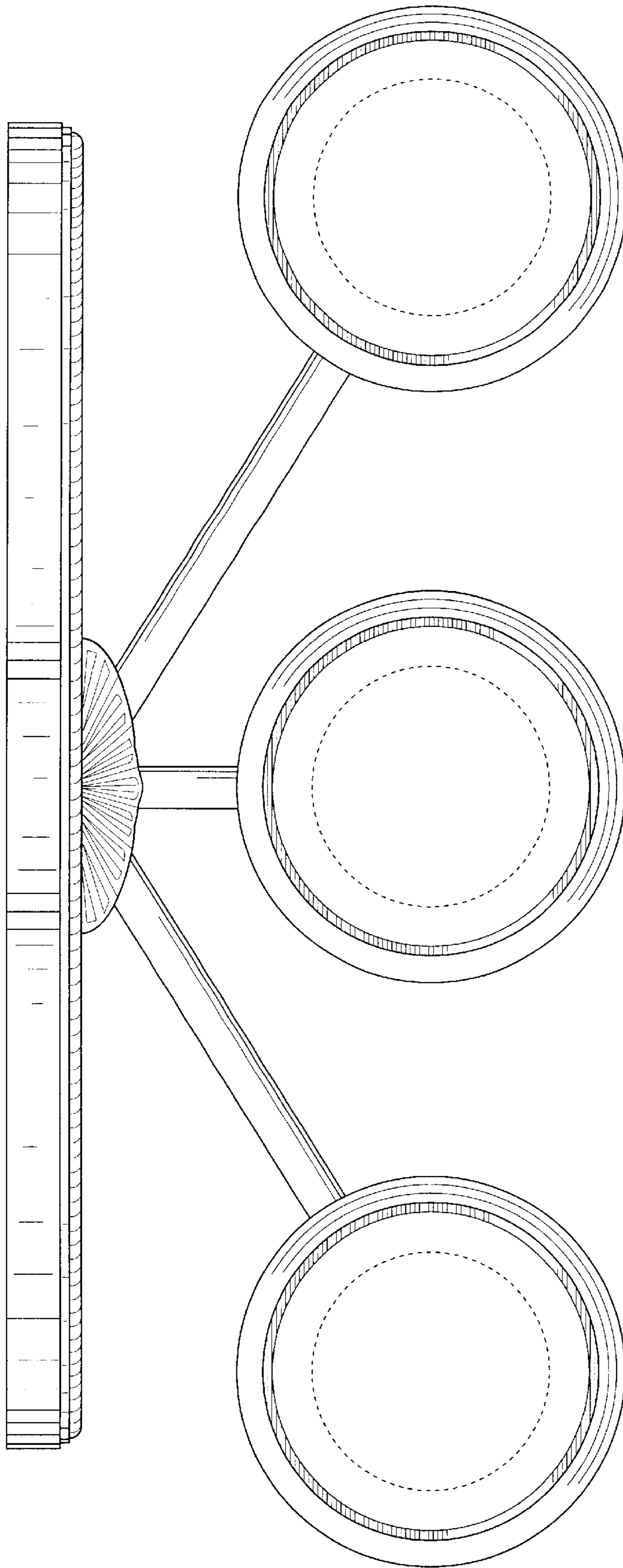

FIG. 7.