



US00D453014S

(12) **United States Design Patent**
Fraser

(10) **Patent No.:** **US D453,014 S**

(45) **Date of Patent:** **** Jan. 22, 2002**

(54) **AIRCRAFT**

Primary Examiner—Marcus A. Jackson

(76) **Inventor:** **Norman Thomas Laurence Fraser,**
4597 Candleberry Ave., Seal Beach, CA
(US) 90740-3026

(57) **CLAIM**

The ornamental design for a aircraft, as shown and described.

(**) **Term:** **14 Years**

DESCRIPTION

(21) **Appl. No.:** **29/139,973**

FIG. 1 is a left side perspective view of a first twin engine embodiment of an aircraft showing my new design.

(22) **Filed:** **Apr. 10, 2001**

FIG. 2 is a left side elevation view thereof, with the opposite side being a mirror image;

(51) **LOC (7) Cl.** **12-07**

(52) **U.S. Cl.** **D12/319**

(58) **Field of Search** D12/319-345;
244/45 A, 45 R, 13, 15, 55, 91, 199

FIG. 3 is a front elevational view thereof. This view also applies to my second twin engine aircraft.

FIG. 4 is a top plan view thereof.

(56) **References Cited**

U.S. PATENT DOCUMENTS

D370,456 S	*	6/1996	Buchsel et al.	D12/319
D414,740 S	*	10/1999	Margaritoff	D12/319
D421,955 S	*	3/2000	Birrenback	D12/319

FIG. 5 is a left side perspective view of a second twin engine embodiment of an aircraft showing my new design.

FIG. 6 is a left side elevational view thereof, with the opposite side being a mirror image; and,

FIG. 7 is a top plan view thereof.

* cited by examiner

1 Claim, 3 Drawing Sheets

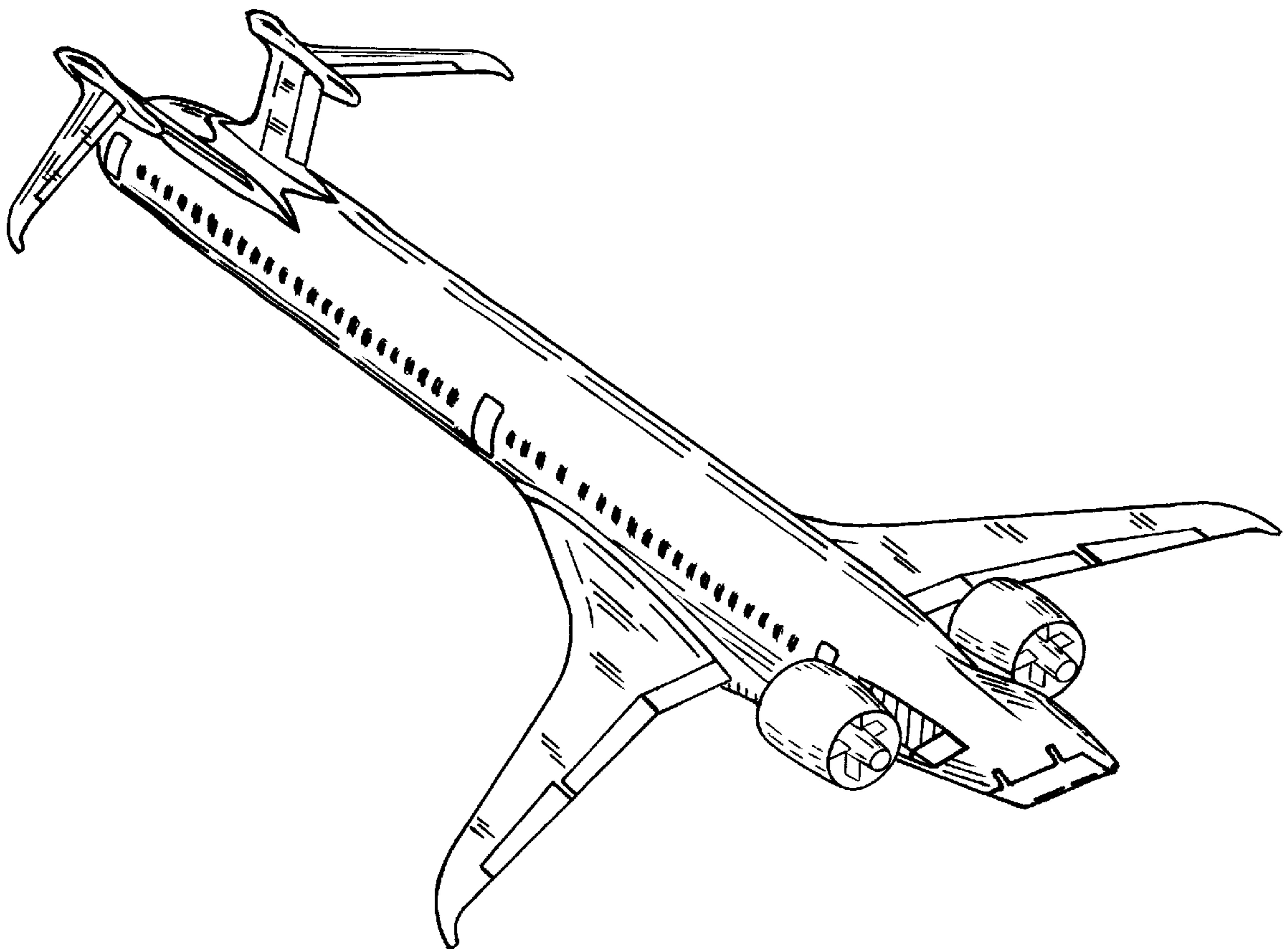

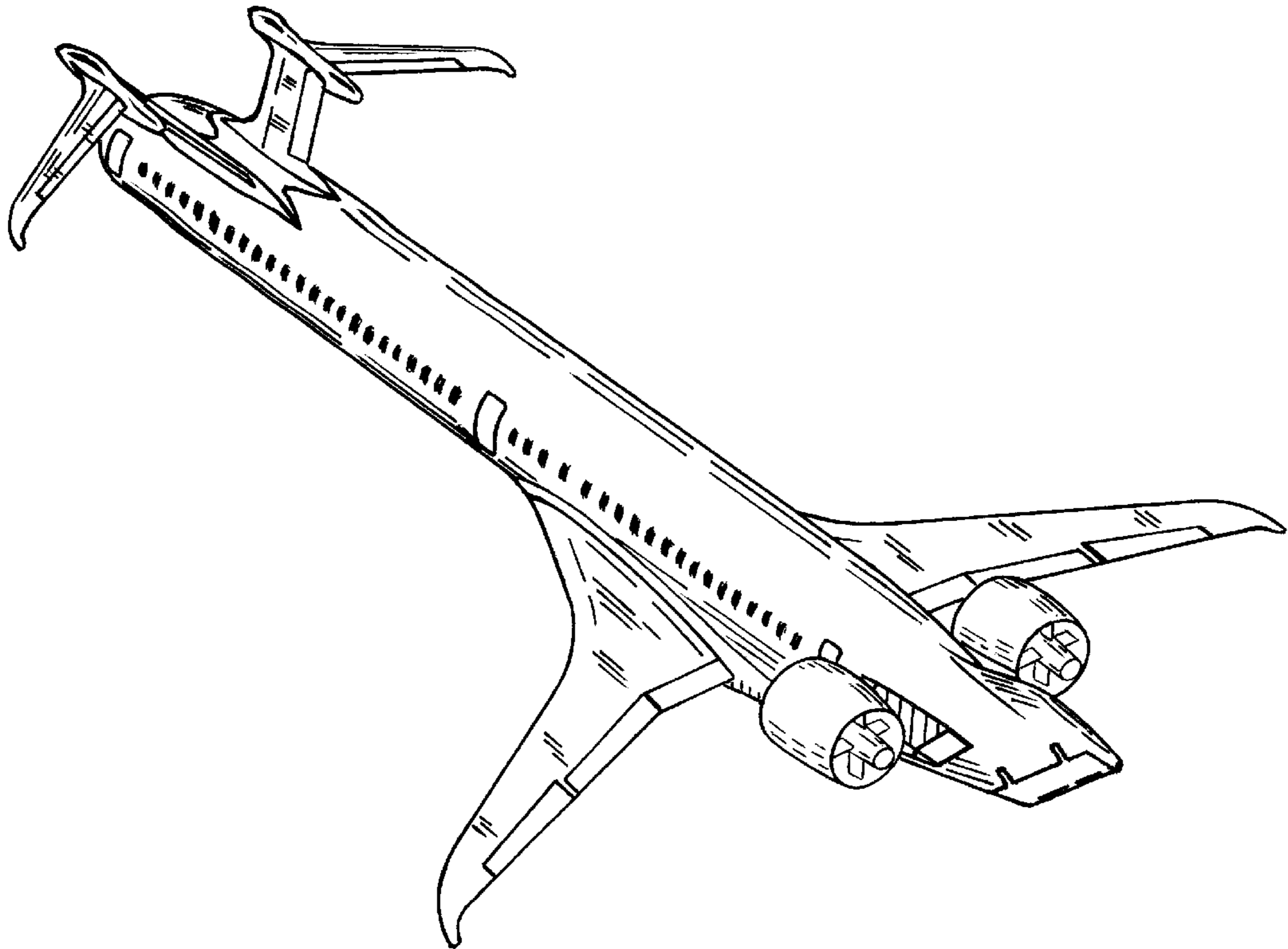

FIG. 1

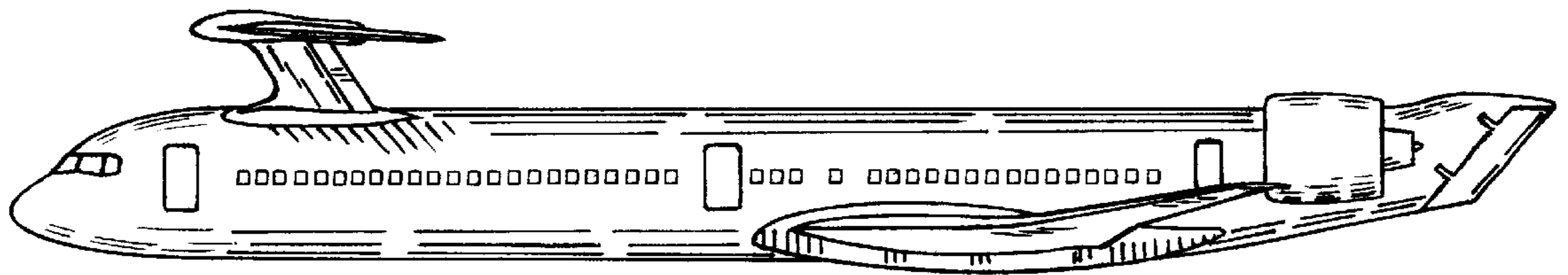

FIG. 2

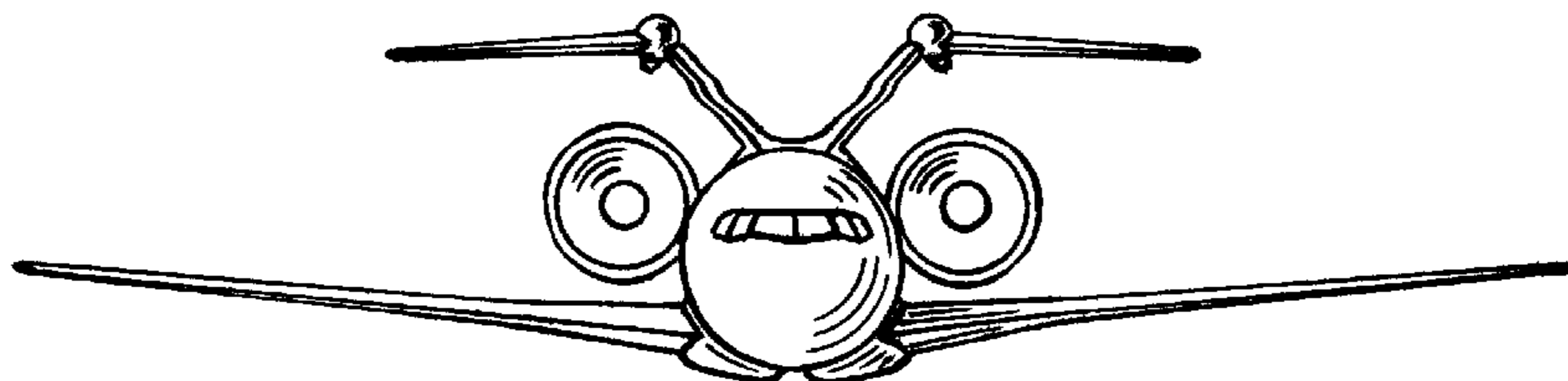

FIG. 3

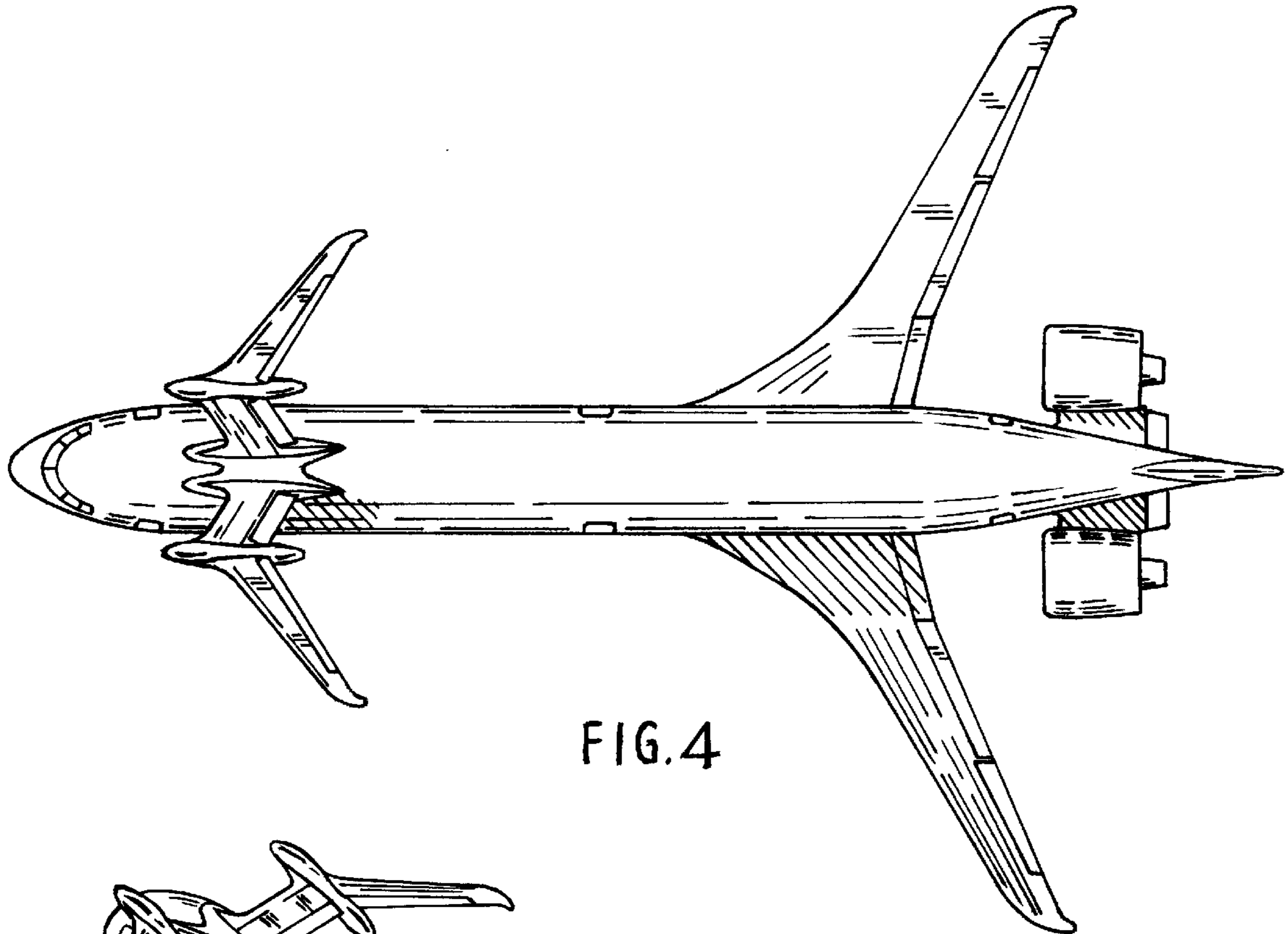

FIG. 4

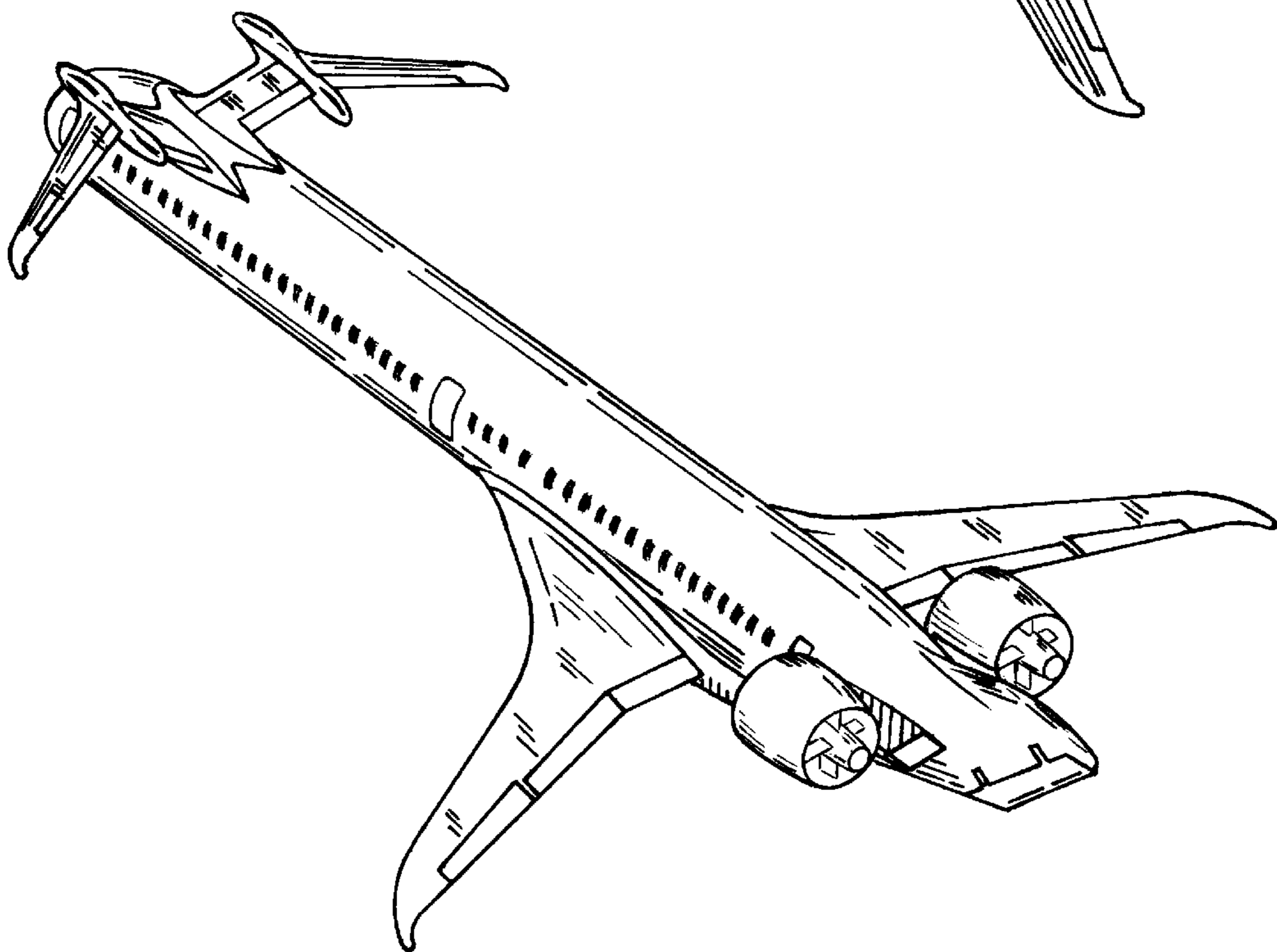

FIG. 5

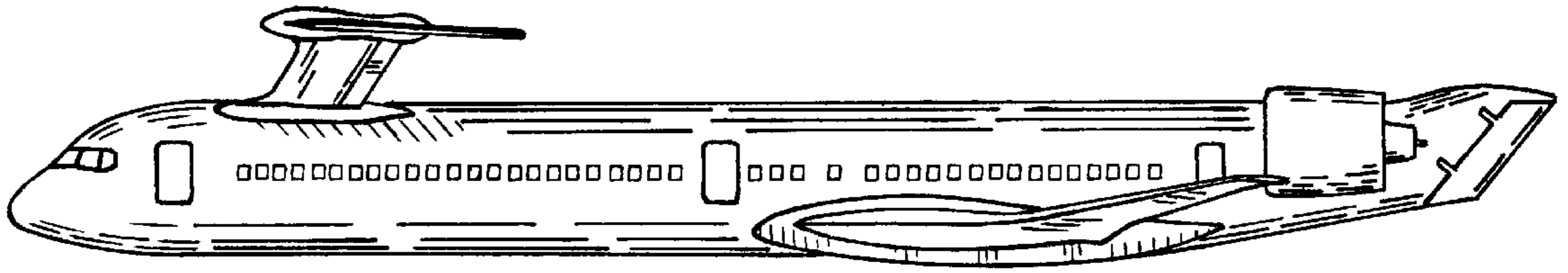

FIG. 6

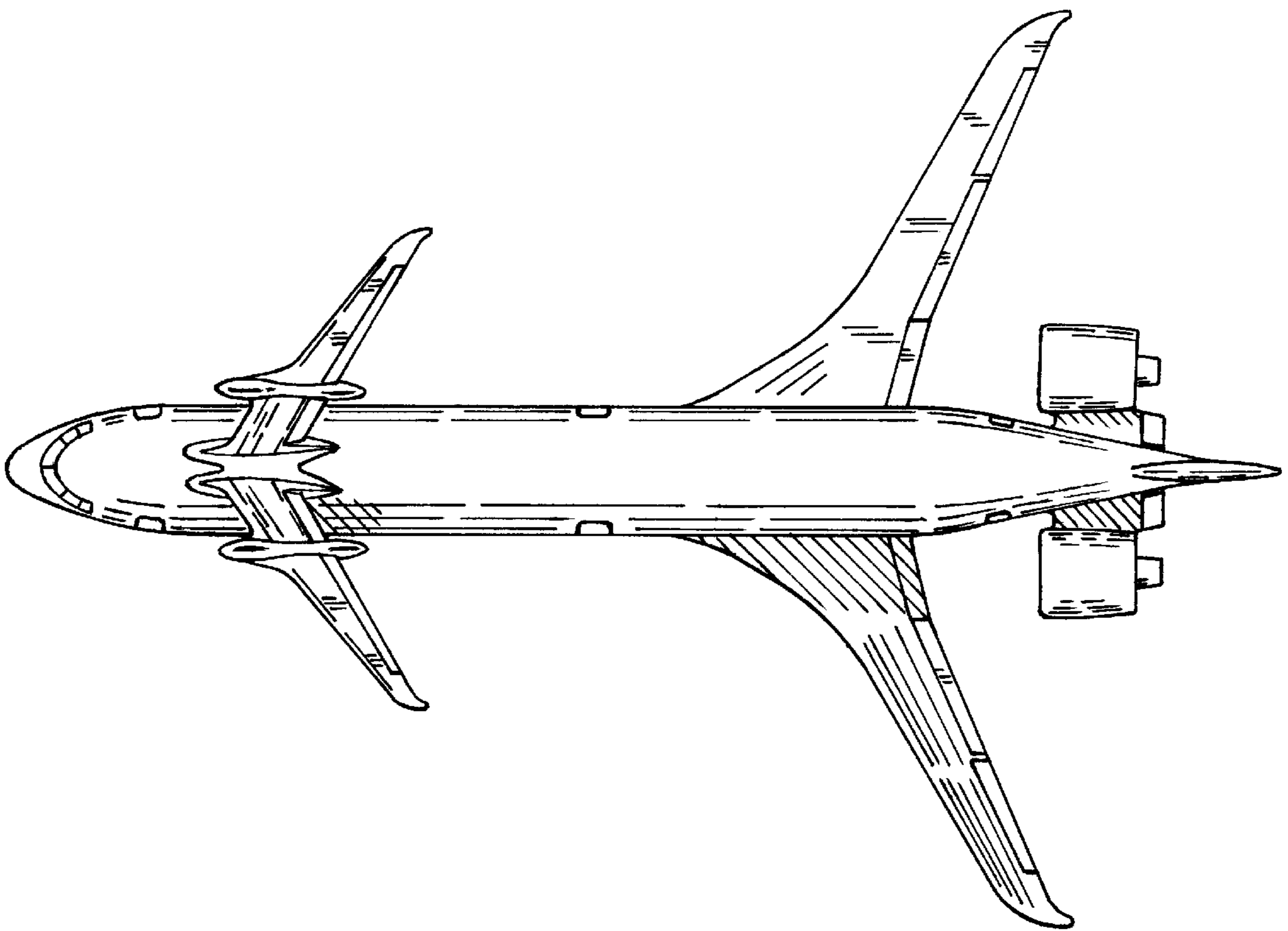

FIG. 7

UNITED STATES PATENT AND TRADEMARK OFFICE
CERTIFICATE OF CORRECTION

PATENT NO. : Des. 453,014 S
DATED : January 22, 2002
INVENTOR(S) : Fraser

Page 1 of 1

It is certified that error appears in the above-identified patent and that said Letters Patent is hereby corrected as shown below:

Drawings,

Sheet 1 of 3 delete fig. 3 and replace with fig. 3 below

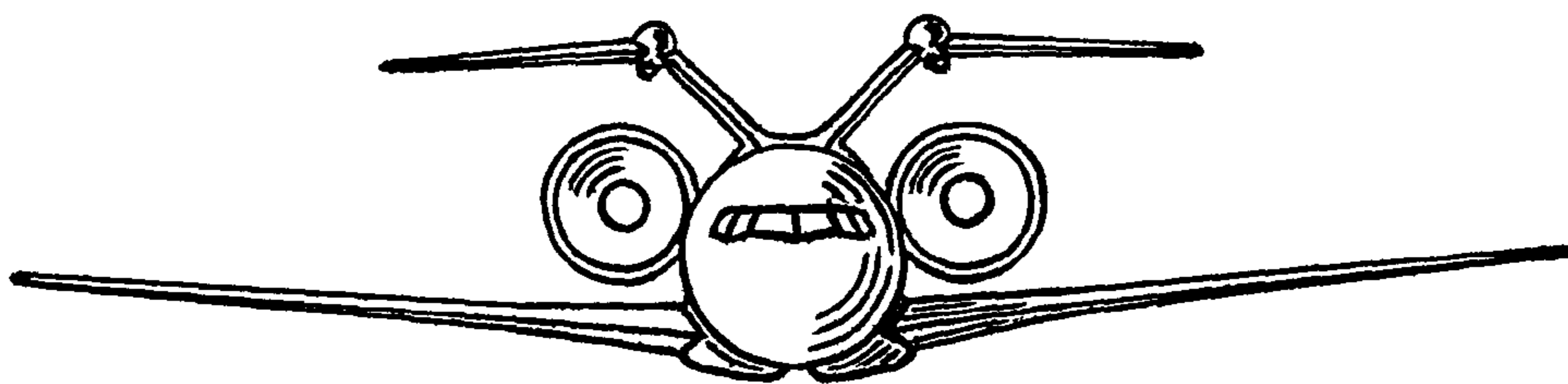

FIG. 3

Signed and Sealed this

Twenty-eighth Day of January, 2003

JAMES E. ROGAN
Director of the United States Patent and Trademark Office