



US00D452863B2

(12) **United States Design Patent**
Madsen et al.

(10) **Patent No.: US D452,863 S**
(45) **Date of Patent: ** Jan. 8, 2002**

(54) **COMMUNICATIONS CARD WITH A
RECEPTACLE FOR RECEIVING A RJ-TYPE
CONNECTOR PLUG**

(75) Inventors: **Brent D. Madsen**, Providence; **David
Oliphant**, West Jordan; **John Marshall**,
Provo, all of UT (US)

(73) Assignee: **3Com Corporation**, Santa Clara, CA
(US)

(**) Term: **14 Years**

(21) Appl. No.: **29/141,949**

(22) Filed: **May 16, 2001**

Related U.S. Application Data

(63) Continuation of application No. 09/528,331, filed on Mar.
20, 2000, and a continuation of application No. 09/528,501,
filed on Mar. 20, 2000.

(51) **LOC (7) Cl.** **14-02**

(52) **U.S. Cl.** **D14/433; D14/435**

(58) **Field of Search** **D14/432-438;**
439/638, 676, 946, 607

(56) **References Cited**

U.S. PATENT DOCUMENTS

2,916,720 A	12/1959	Steans	339/91
3,205,471 A	9/1965	Herrmann	339/176
3,860,316 A	1/1975	Hardesty	439/344
4,186,988 A	2/1980	Kobler	339/176
4,239,316 A	12/1980	Spaulding	439/344
4,241,974 A	12/1980	Hardesty	339/154
4,268,109 A	5/1981	Hardesty	439/676
4,303,296 A *	12/1981	Spaulding	439/638
4,352,492 A	10/1982	Smith	271/1
4,407,559 A	10/1983	Meyer	339/126
4,428,636 A	1/1984	Kam et al.	339/97
4,566,749 A	1/1986	Johnston	339/95 D
4,602,842 A	7/1986	Free et al.	339/156
4,647,136 A	3/1987	Kinoshita et al.	339/125 R
4,710,136 A	12/1987	Suzuki	439/374
4,778,410 A	10/1988	Tanaka	439/676

4,875,872 A	10/1989	Tanaka	439/344
4,915,648 A	4/1990	Takase et al.	439/490
5,035,641 A	7/1991	Van-Santbrink et al.	439/329
5,051,099 A	9/1991	Pickles et al.	439/108
5,139,439 A	8/1992	Shie	439/359
5,183,404 A	2/1993	Aldous et al.	439/55
5,184,282 A	2/1993	Kaneda et al.	361/395
5,310,360 A	5/1994	Peterson	439/571
5,336,099 A	8/1994	Aldous et al.	439/131
5,338,210 A	8/1994	Bechmam et al.	439/131

(List continued on next page.)

FOREIGN PATENT DOCUMENTS

JP	61-256850	8/1985
WO	WO95/13633	5/1995

* cited by examiner

Primary Examiner—Kay H. Chin

(74) *Attorney, Agent, or Firm*—Workman, Nydegger &
Seeley

(57) **CLAIM**

The ornamental design for a communications card with a
receptacle for receiving a RJ-type connector plug, as shown
and described.

DESCRIPTION

FIG. 1 is a perspective view of a communications card with
a receptacle for receiving a RJ-type connector plug of the
present invention;
FIG. 2 is a right side view of the communications card
shown in FIG. 1;
FIG. 3 is a top plan view of the communications card shown
in FIG. 1;
FIG. 4 is a left side view of the communications card shown
in FIG. 1;
FIG. 5 is a bottom plan view of the communications card
shown in FIG. 1;
FIG. 6 is a back elevational view of the communications
card shown in FIG. 1; and,
FIG. 7 is a front elevational view of the communications
card shown in FIG. 1.

1 Claim, 4 Drawing Sheets

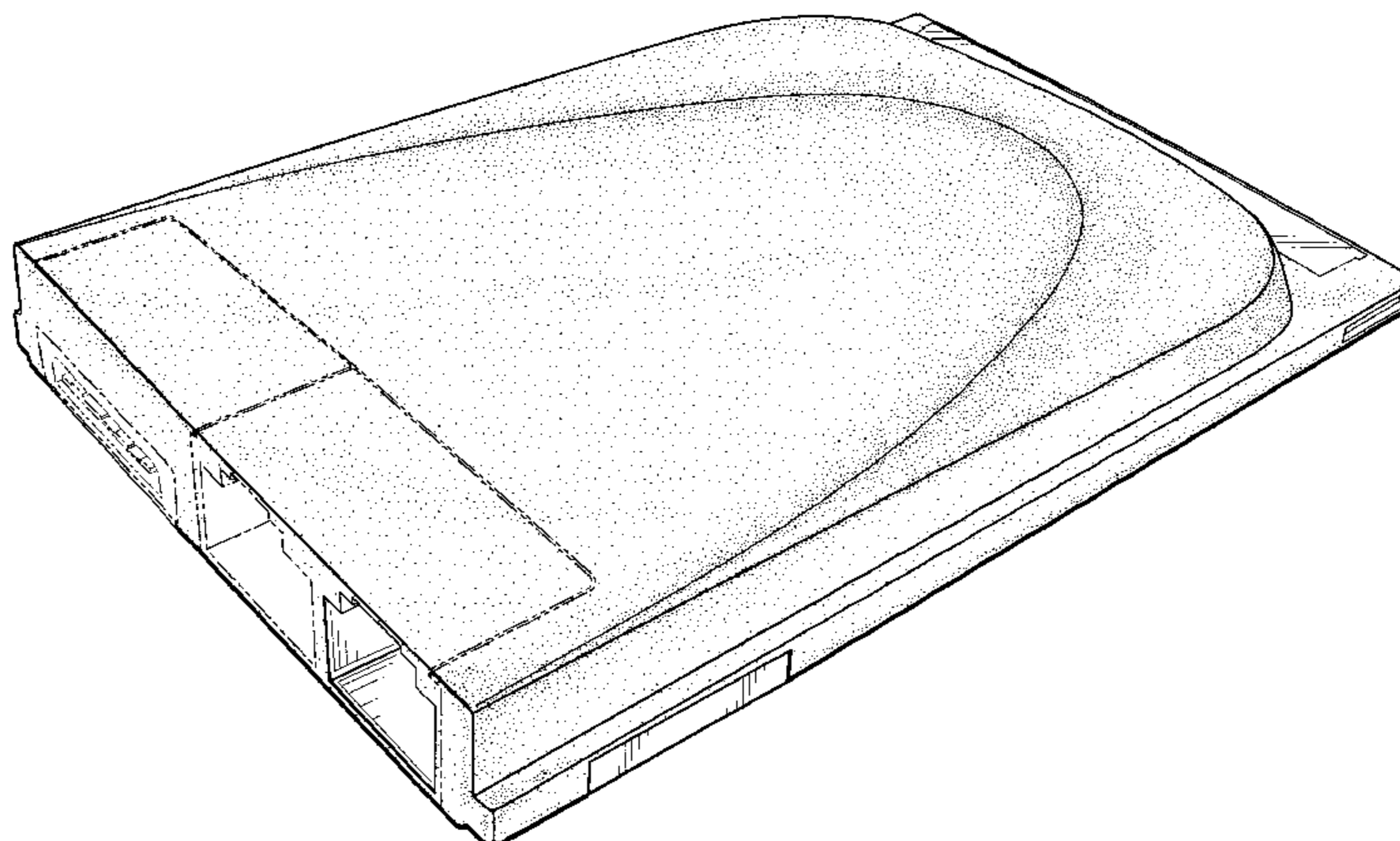

US D452,863 S

Page 2

U.S. PATENT DOCUMENTS

5,364,294 A	11/1994	Hatch et al.	439/676	5,679,013 A	10/1997	Matsunaga et al.	439/144
5,391,083 A	2/1995	Roebuck et al.	439/76	5,697,815 A	12/1997	Drewnicki	439/638
5,391,094 A	2/1995	Kakinoki et al.	439/638	5,727,972 A	3/1998	Aldous et al.	439/655
5,411,405 A	5/1995	McDaniels et al.	439/131	5,773,332 A	6/1998	Glad	439/344
5,425,660 A	6/1995	Weikle	439/676	5,797,771 A	8/1998	Garside	439/610
5,445,534 A	8/1995	Ishizuka	439/352	5,816,832 A	10/1998	Aldous et al.	439/131
5,457,601 A	10/1995	Georgopoulos et al.	361/686	5,820,414 A *	10/1998	Omori	439/638
5,478,261 A	12/1995	Bogese, II	439/676	5,876,218 A	3/1999	Liebenow et al.	439/74
5,481,616 A	1/1996	Freadman	381/90	5,938,480 A	8/1999	Aldous et al.	439/676
5,499,923 A	3/1996	Archibald et al.	439/26	D413,879 S *	9/1999	Wu	D14/435
5,505,633 A	4/1996	Broadbent	439/329	5,980,322 A	11/1999	Madsen et al.	439/621
5,509,811 A	4/1996	Homic	439/55	5,984,731 A	11/1999	Laity	439/676
5,538,442 A	7/1996	Okada	439/676	5,989,042 A	11/1999	Johnson et al.	439/131
5,547,401 A	8/1996	Aldous et al.	439/676	6,005,774 A	12/1999	Chiba et al.	361/737
5,561,727 A	10/1996	Akita et al.	439/676	6,033,240 A	3/2000	Goff	439/131
5,562,504 A	10/1996	Moshayedi	439/638	6,611,962	9/2000	Laity	439/676
5,580,274 A	12/1996	Tsair	439/571	6,164,989 A *	12/2000	Glad et al.	439/131
5,608,607 A	3/1997	Dittmer	361/686	6,174,205 B1 *	1/2001	Madsen et al.	439/638
5,634,802 A	6/1997	Kerklaan	439/131	6,217,391 B1	4/2001	Colantuono et al.	439/676
5,660,568 A	8/1997	Moshayedi	439/654				

* cited by examiner

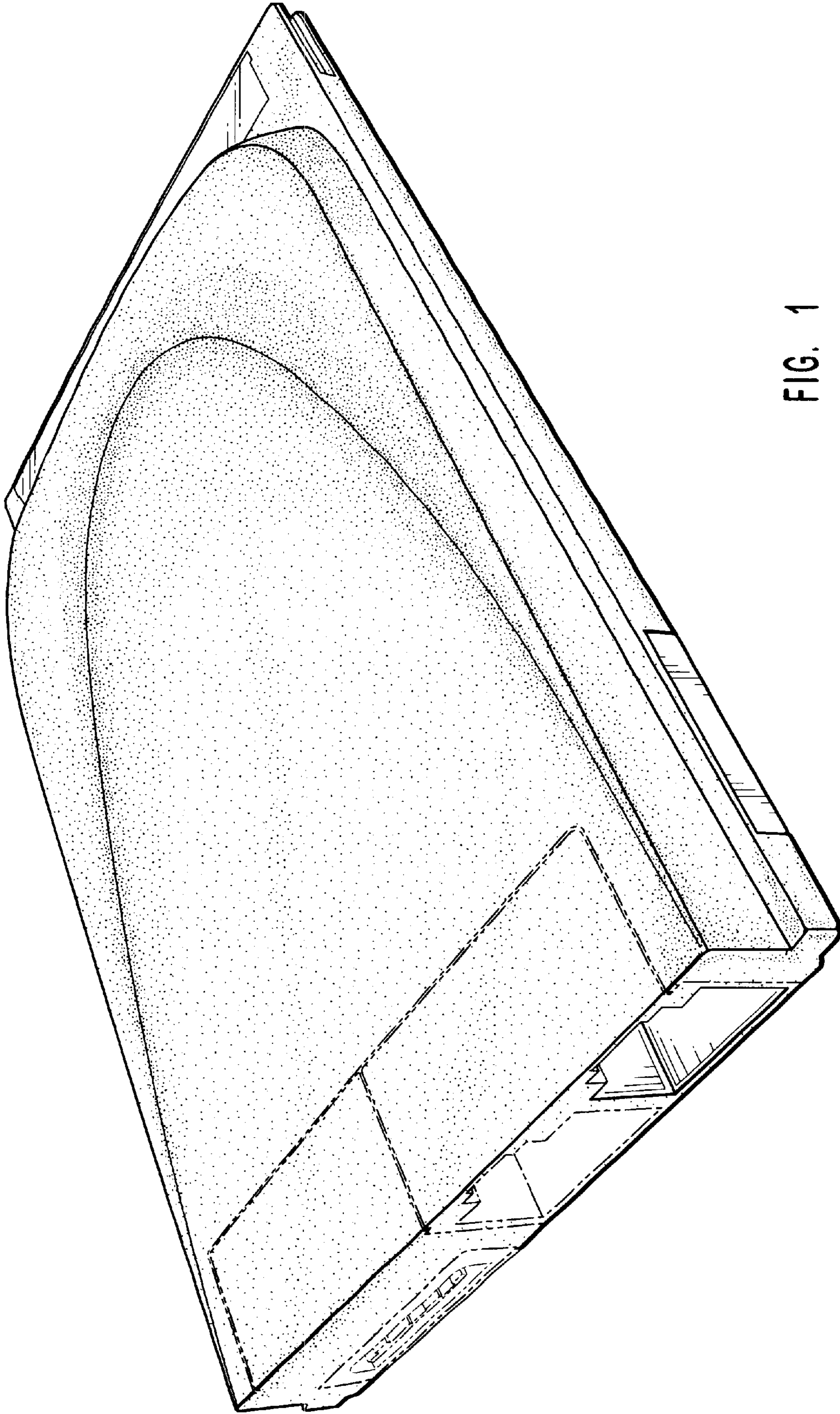

FIG. 1

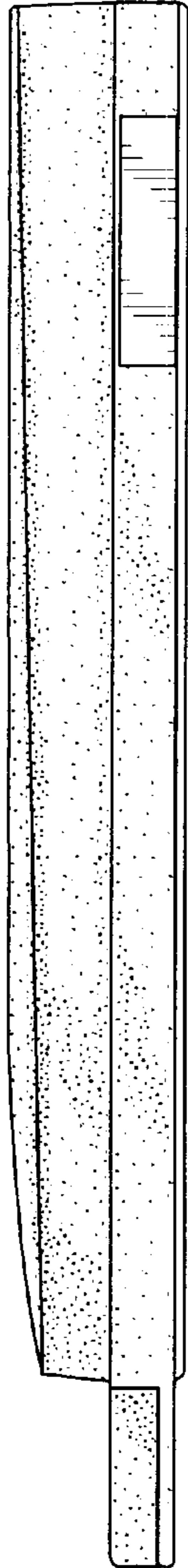

FIG. 2

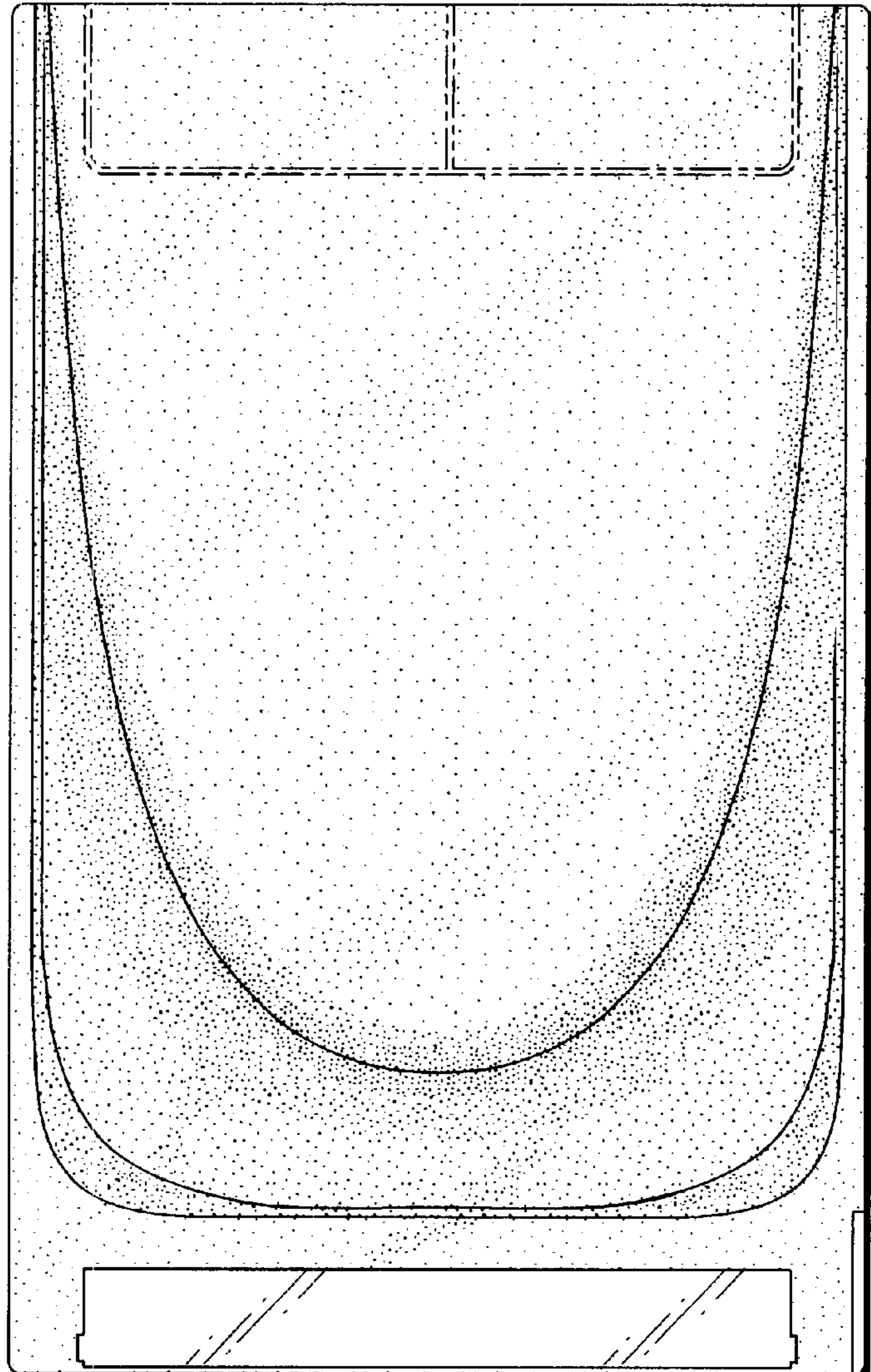

FIG. 3

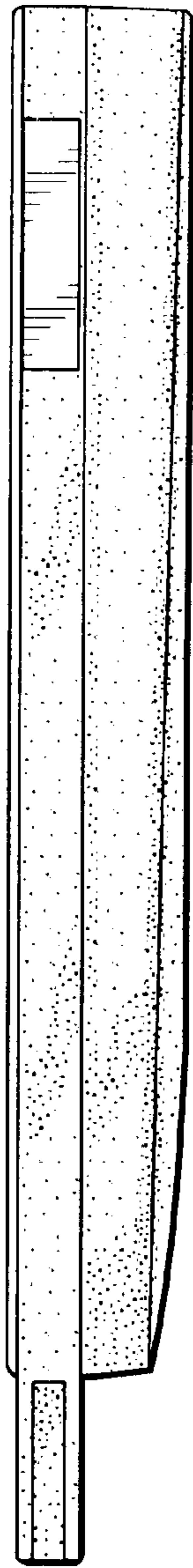

FIG. 4

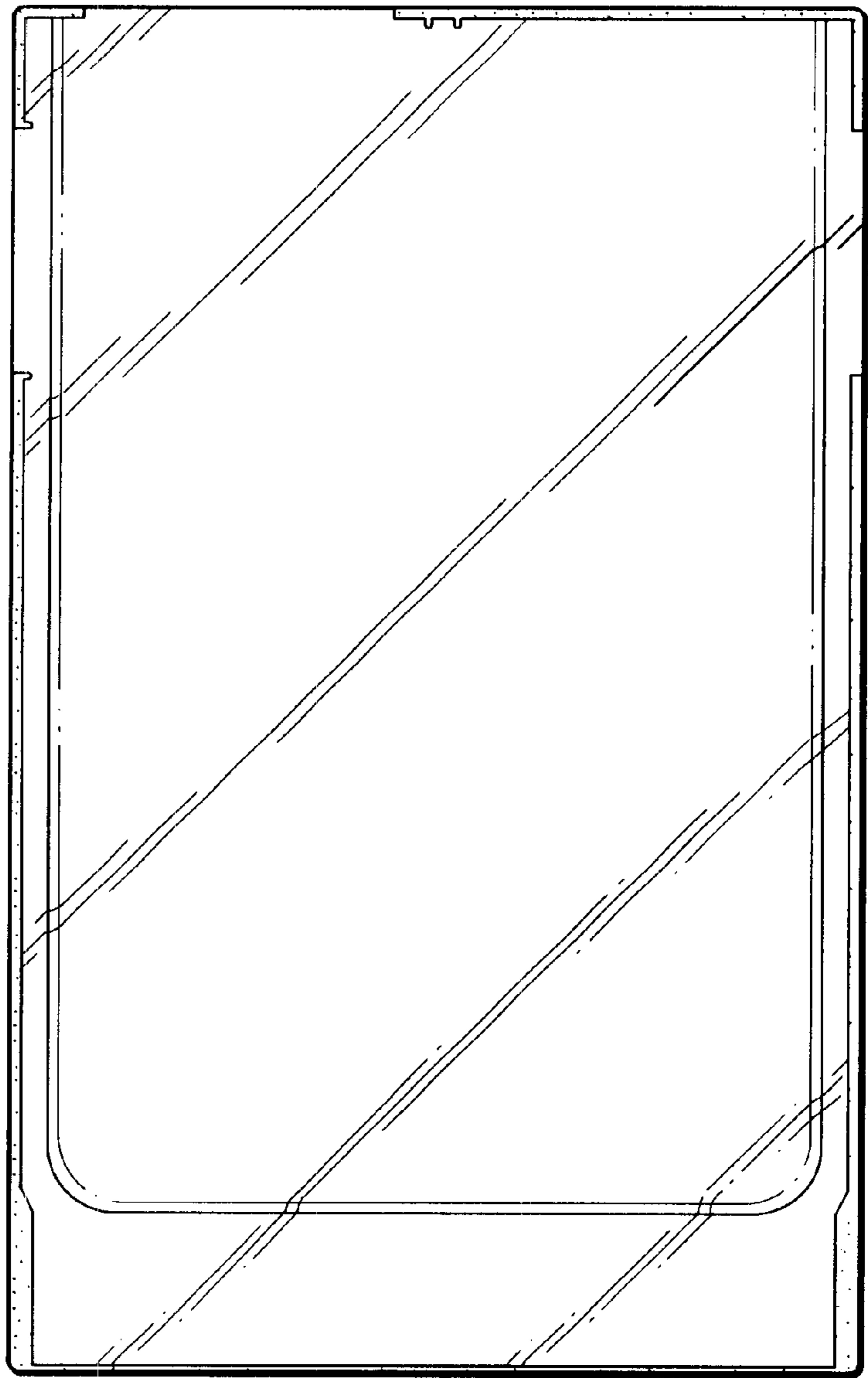

FIG. 5

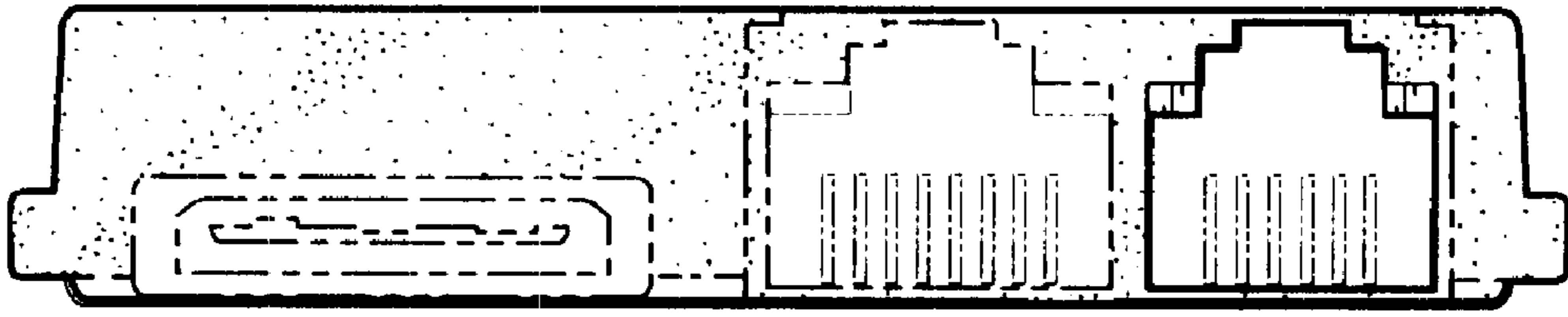

FIG. 6

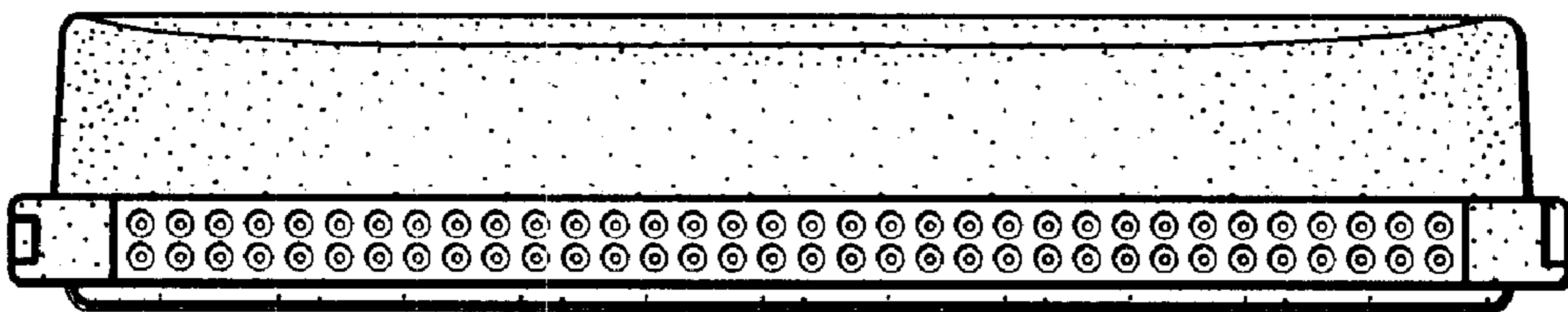

FIG. 7