



US00D452857B1

(12) **United States Design Patent**
Hong

(10) **Patent No.:** **US D452,857 S**

(45) **Date of Patent:** **** Jan. 8, 2002**

(54) **HANDS FREE MICROPHONE AND
EARPHONE**

D407,089 S * 3/1999 Norin D14/206
D420,007 S * 2/2000 Marshall et al. D14/223
6,101,260 A * 8/2000 Jensen et al. 381/381

(76) **Inventor:** **Chi-Lin Hong**, 3F No.5, Alley 6, Lane
45, Pao-Hsin Rd., Hsin-Tien City,
Taipei Hsien (TW)

* cited by examiner

Primary Examiner—Nanda Bondade

(74) *Attorney, Agent, or Firm*—Rabin & Berdo, P.C.

(**) **Term:** **14 Years**

(57) **CLAIM**

(21) **Appl. No.:** **29/141,308**

The ornamental design for a hands free microphone and earphone, as shown and described.

(22) **Filed:** **May 4, 2001**

DESCRIPTION

(51) **LOC (7) Cl.** **14-01**

(52) **U.S. Cl.** **D14/223; D14/206**

(58) **Field of Search** D14/188, 192,
D14/205–206, 223, 225–229; 181/129–130;
379/430, 433; 381/370, 376–381

FIG. 1 is a front view of a hands free microphone and earphone showing my new design;
FIG. 2 is a rear elevational view thereof;
FIG. 3 is a left side elevational view thereof;
FIG. 4 is a right side elevational view thereof;
FIG. 5 is a top plan view thereof;
FIG. 6 is a bottom plan view thereof; and,
FIG. 7 is a perspective view thereof.

(56) **References Cited**

U.S. PATENT DOCUMENTS

5,787,166 A * 7/1998 Ullman 379/430
D403,327 S * 12/1998 Landreth et al. D14/223

1 Claim, 4 Drawing Sheets

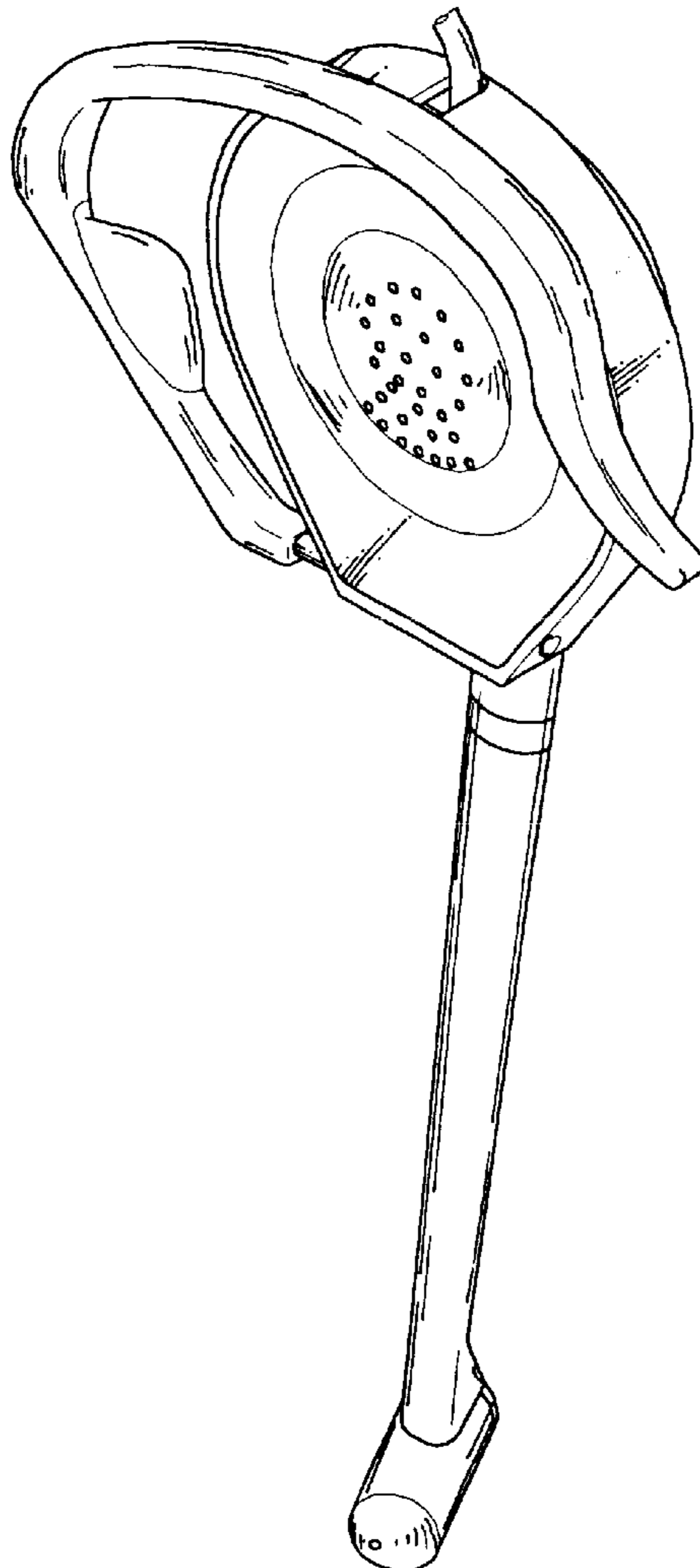

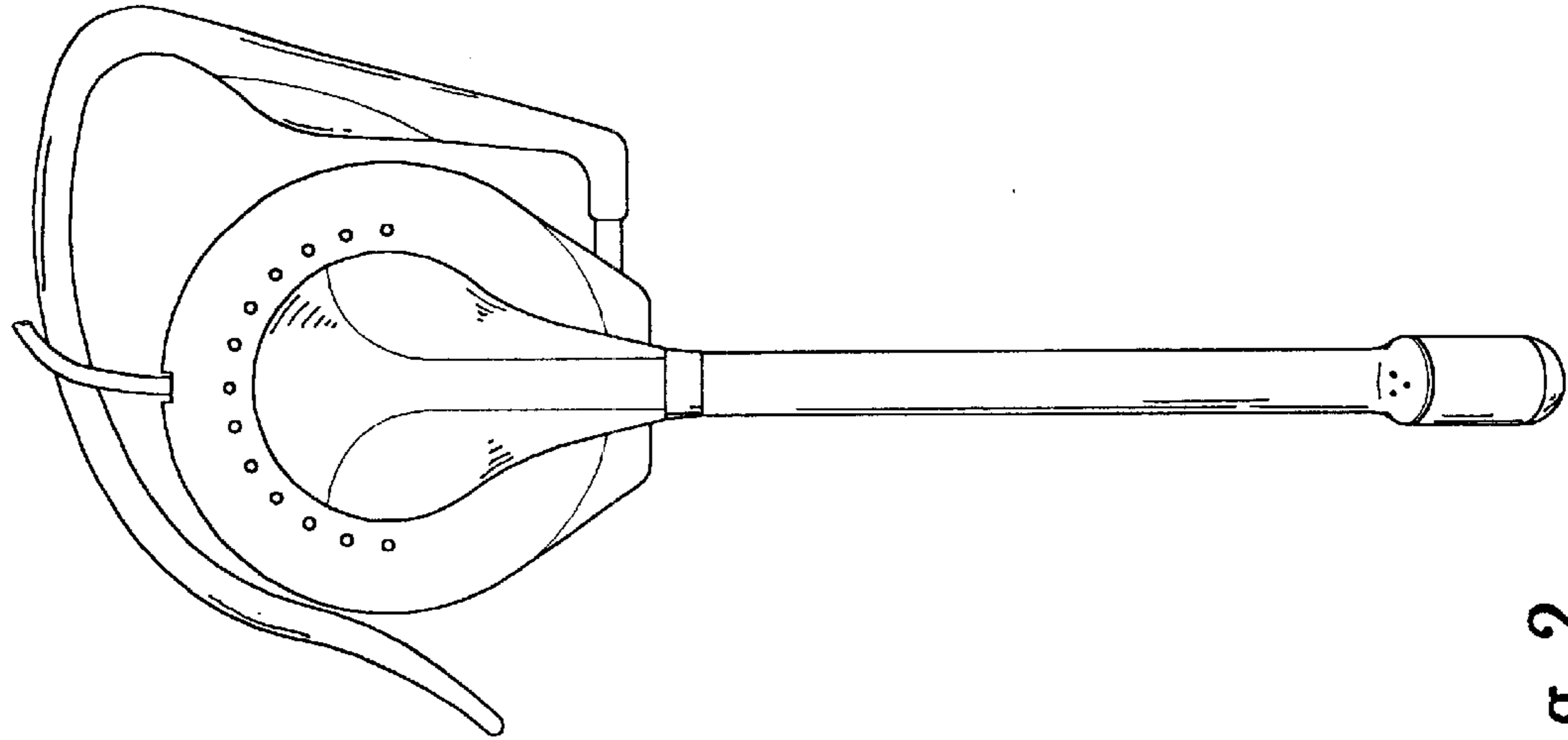

Fig. 2

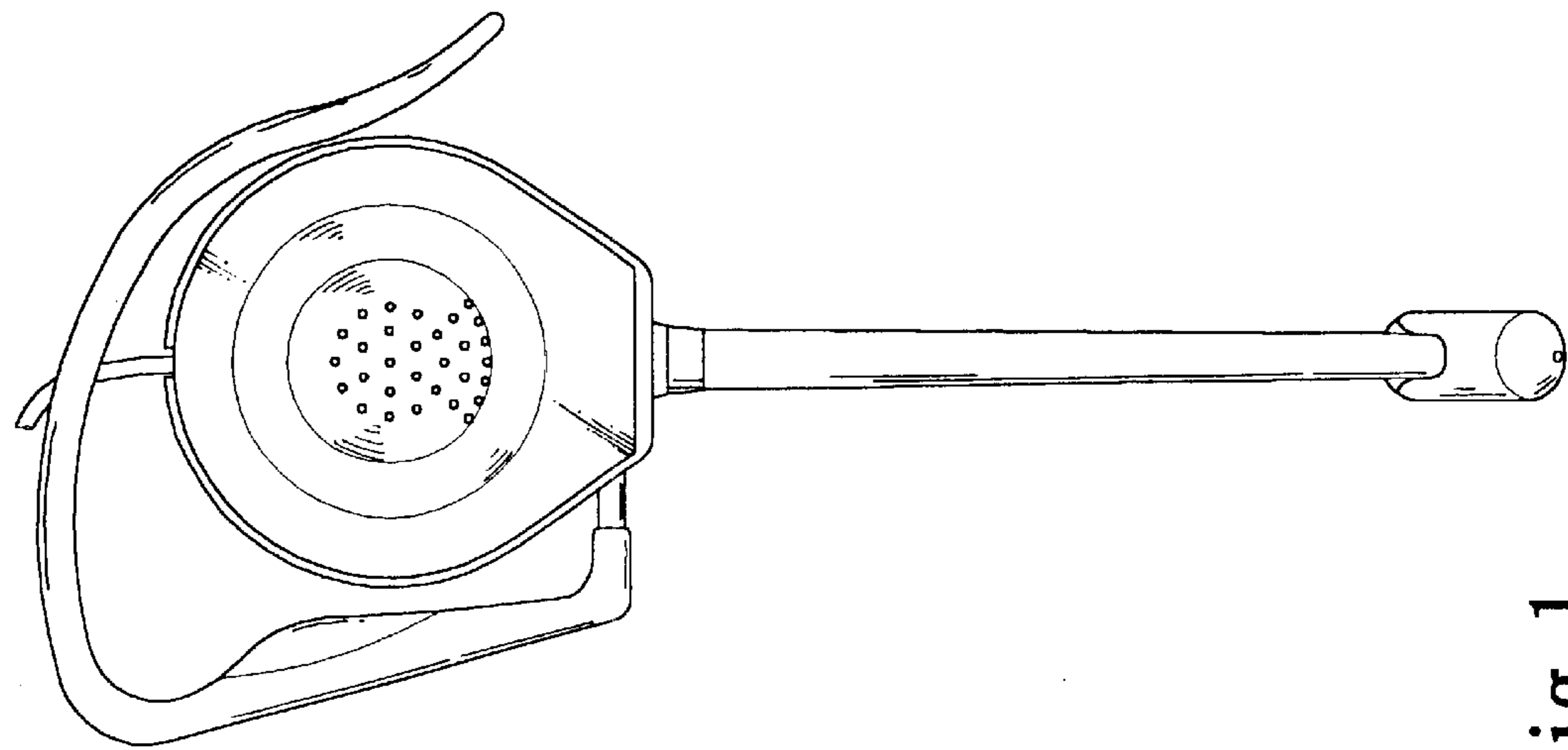

Fig. 1

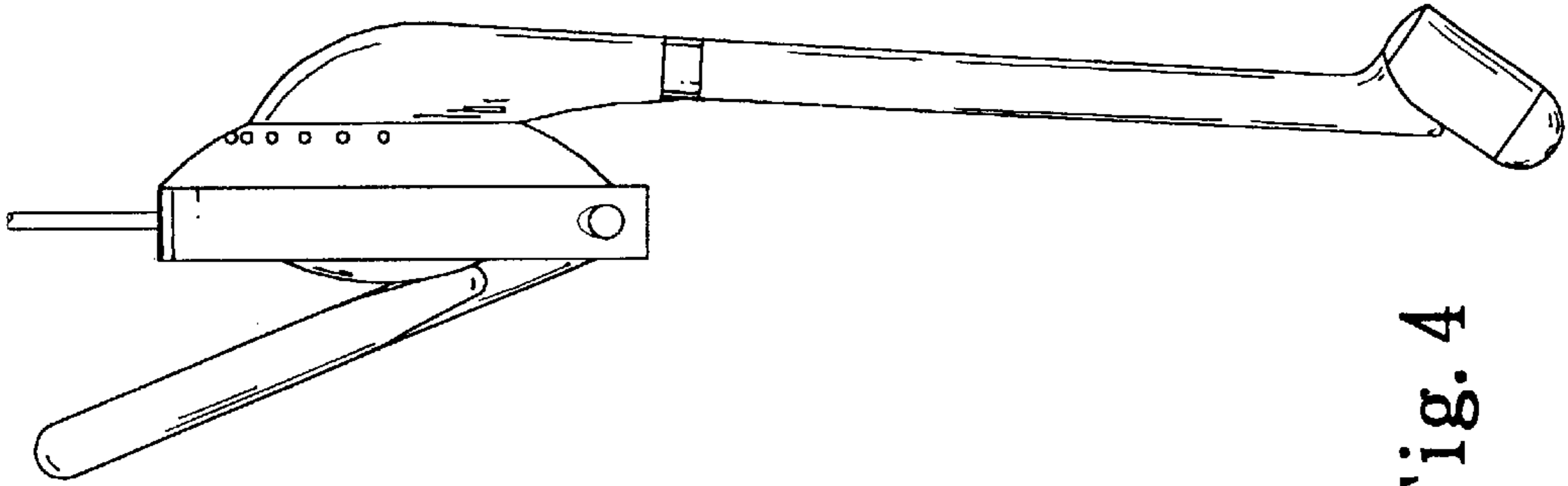

Fig. 4

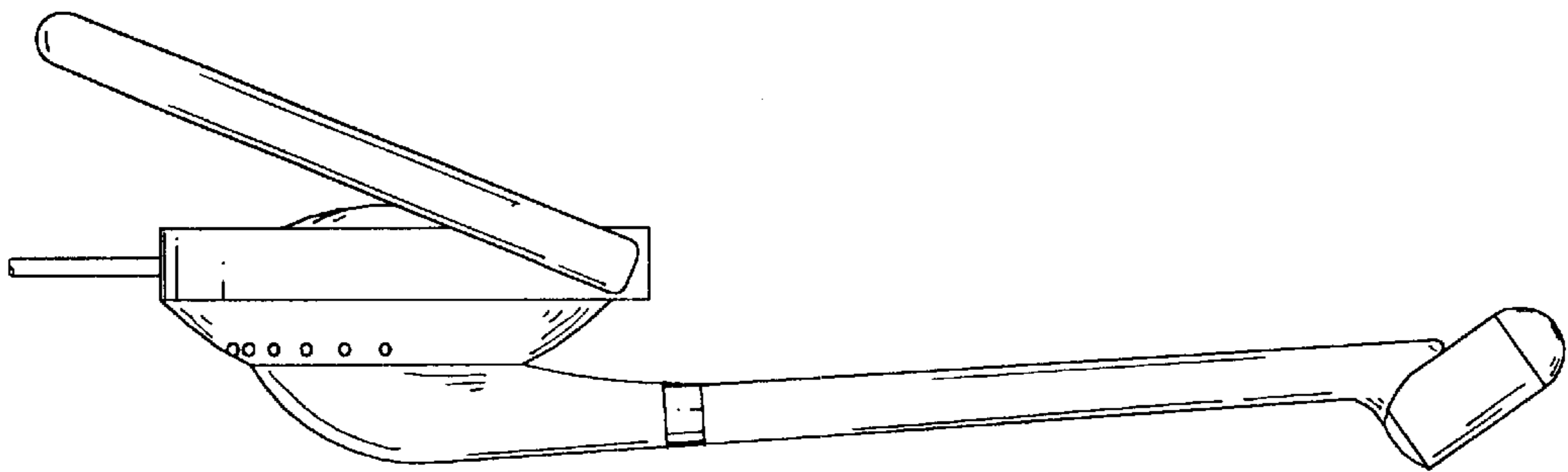

Fig. 3

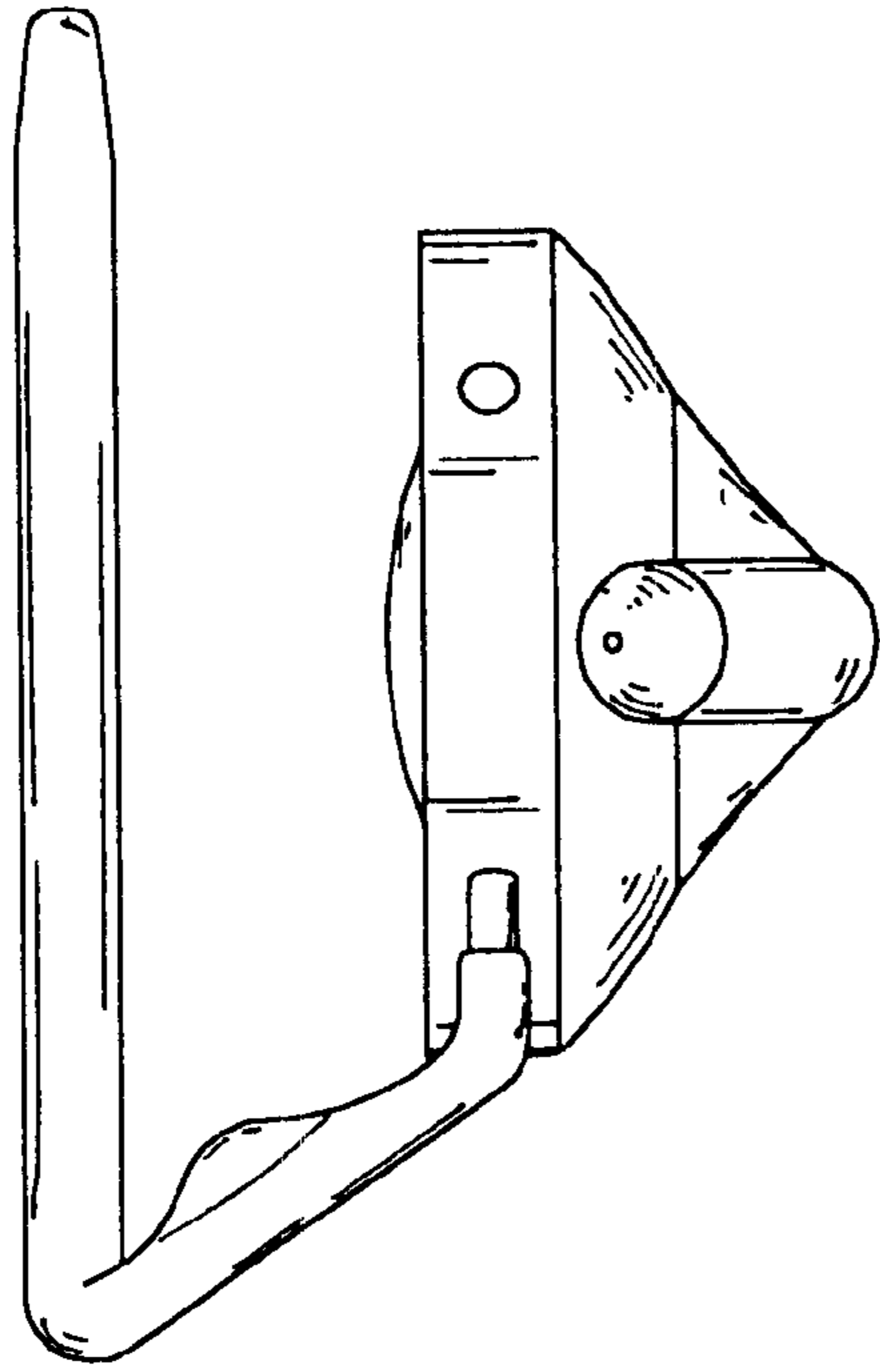

Fig. 6

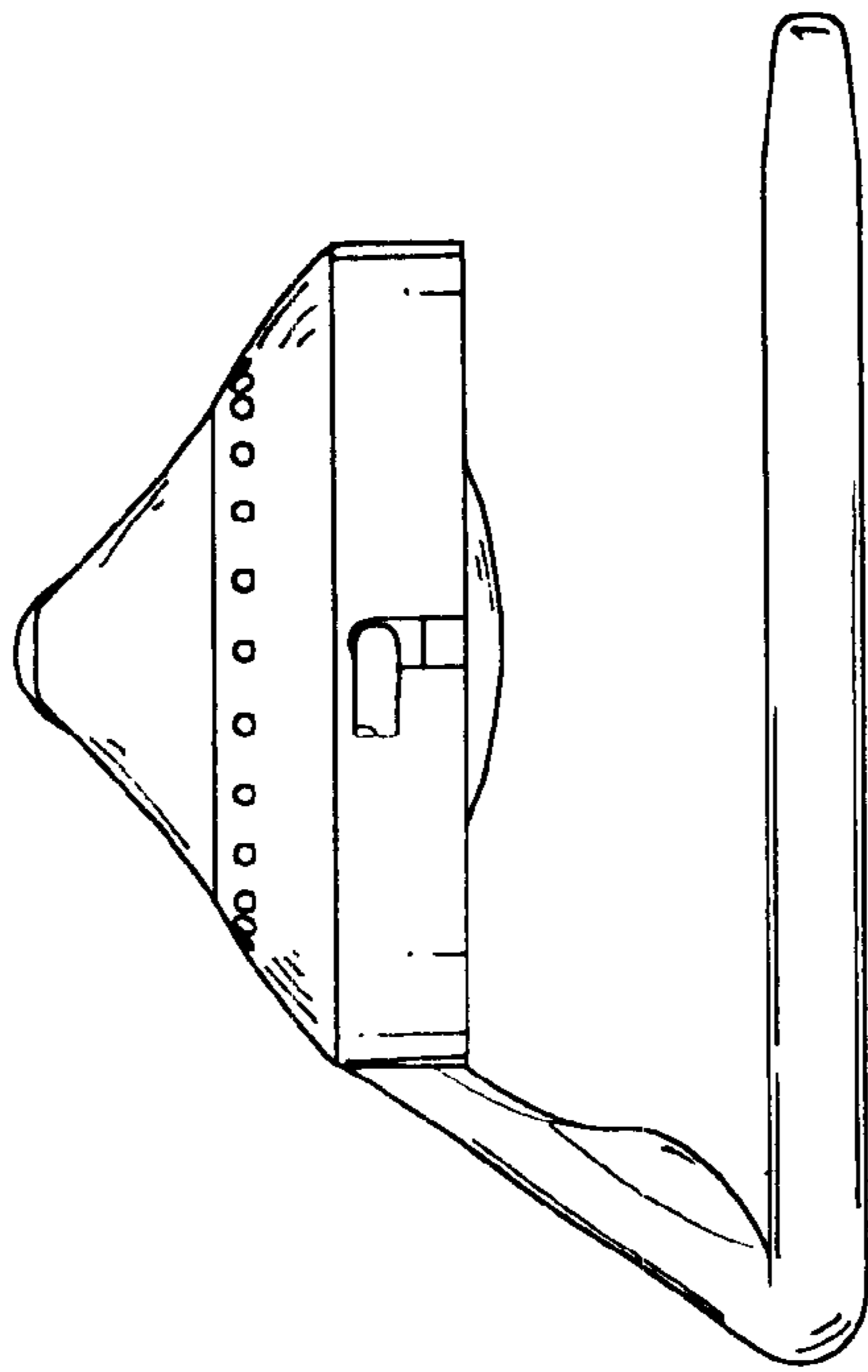

Fig. 5

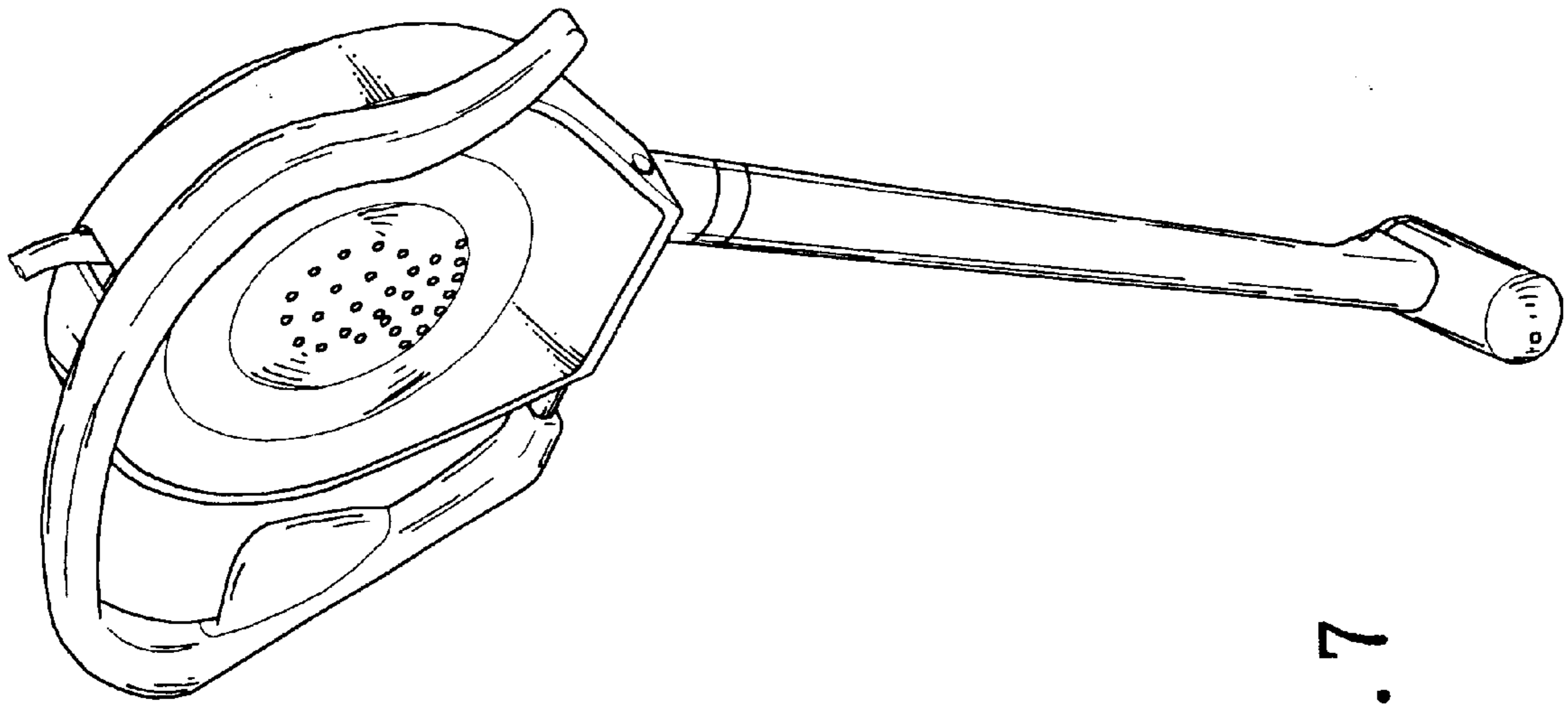

Fig. 7