



US00D452811B1

(12) **United States Design Patent**
Shedd et al.

(10) **Patent No.:** **US D452,811 S**
(45) **Date of Patent:** **** Jan. 8, 2002**

(54) **DOOR STRIKE**

(75) Inventors: **Nathan Shedd; Kent Davidson;**
Patrick Rousseau, all of Calgary (CA)

(73) Assignee: **Smed International Inc.**, Calgary (CA)

(**) Term: **14 Years**

(21) Appl. No.: **29/137,209**

(22) Filed: **Feb. 16, 2001**

Related U.S. Application Data

(62) Division of application No. 29/117,595, filed on Jan. 31, 2000, now Pat. No. Des. 441,272.

(30) **Foreign Application Priority Data**

Sep. 9, 1999 (CA) 1999-2235

(51) **LOC (7) Cl.** **08-07**

(52) **U.S. Cl.** **D8/344**

(58) **Field of Search** D8/330, 343, 344,
D8/345; 292/216, 340, 341-341.19, DIG. 53;
49/460

(56) **References Cited**

U.S. PATENT DOCUMENTS

4,017,106 A	4/1977	Salazar	292/340
4,130,311 A	12/1978	Sushan	292/346
D261,225 S	10/1981	Sterling	D8/344
D339,056 S	9/1993	Black	D8/344
6,085,465 A *	7/2000	Olberding	49/460

* cited by examiner

Primary Examiner—Jennifer Rivard

(74) *Attorney, Agent, or Firm*—Gowling Lafleur Henderson LLP

(57) **CLAIM**

The ornamental design for a door strike, as shown and described.

DESCRIPTION

FIG. 1 is a perspective view of an embodiment of the door strike according to the present invention;
 FIG. 2 is an end elevation of the door strike shown in FIG. 1;
 FIG. 3 is a front elevation of the door strike shown in FIG. 1;
 FIG. 4 is a rear elevation of the door strike shown in FIG. 1;
 FIG. 5 is a top plan view of the door strike shown in FIG. 1;
 FIG. 6 is a bottom plan view of the door strike shown in FIG. 1;
 FIG. 7 is a perspective view of a second embodiment of the door strike according to the present invention;
 FIG. 8 is an end elevation of the door strike shown in FIG. 7;
 FIG. 9 is a front elevation of the door strike shown in FIG. 7;
 FIG. 10 is a top plan view of the door strike shown in FIG. 7;
 FIG. 11 is a rear elevation of the door strike shown in FIG. 7; and,
 FIG. 12 is a bottom plan view of the door strike shown in FIG. 7.
 The broken lines are shown for illustrative purposes and form no part of the claimed design.

1 Claim, 5 Drawing Sheets

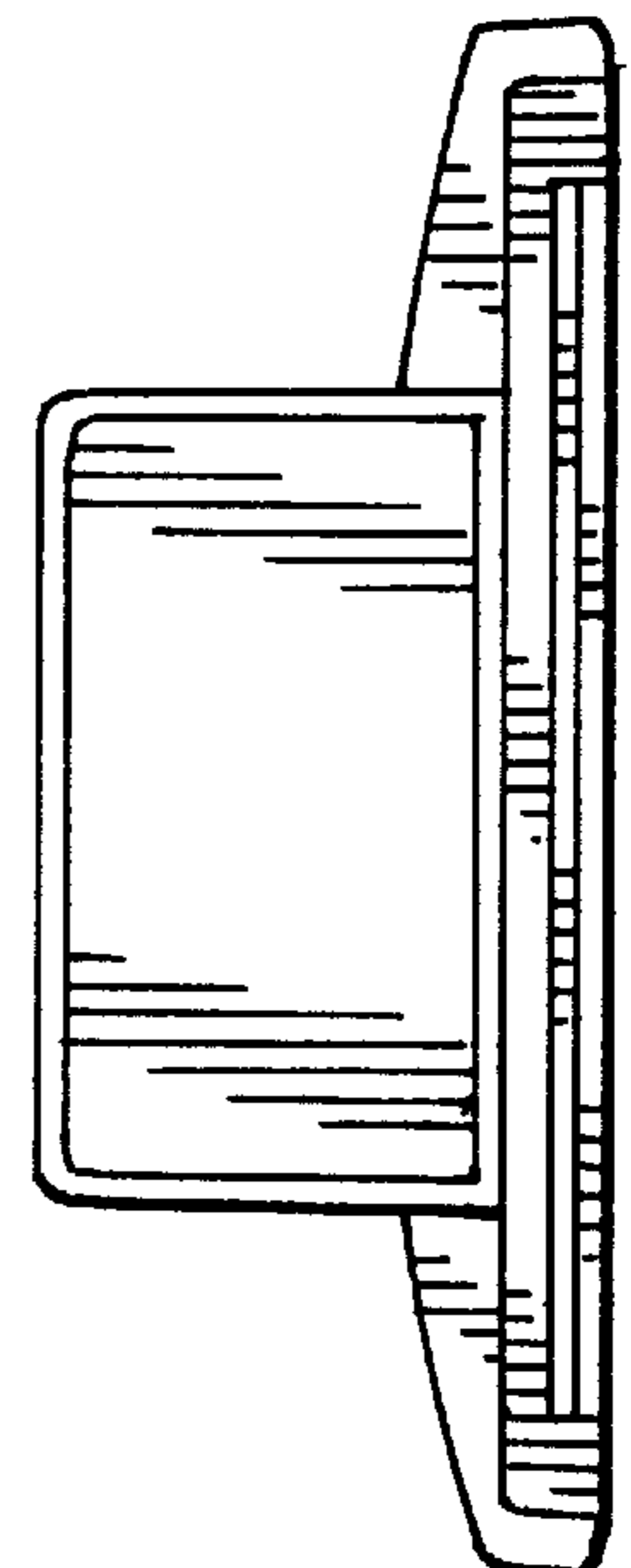
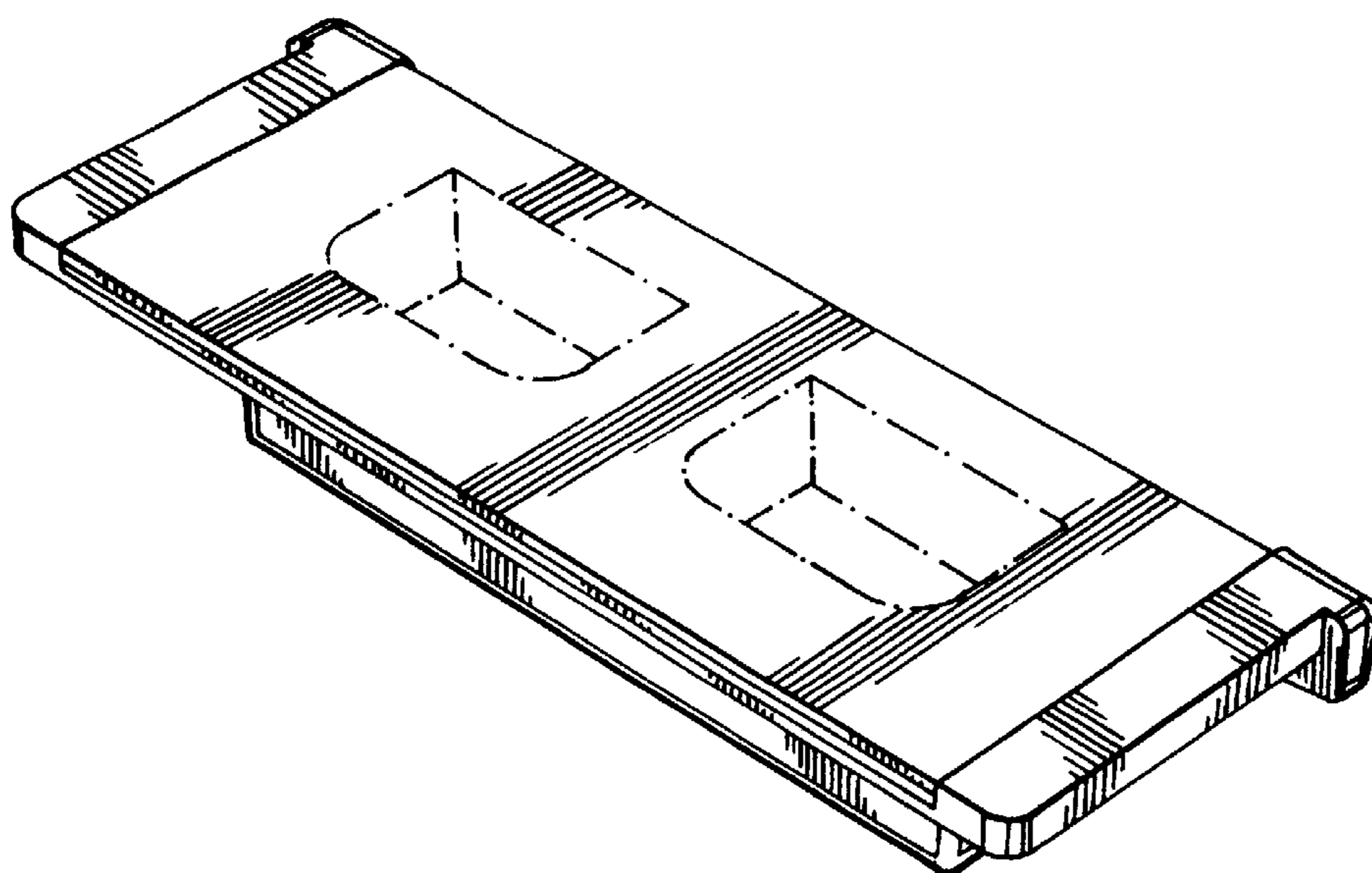

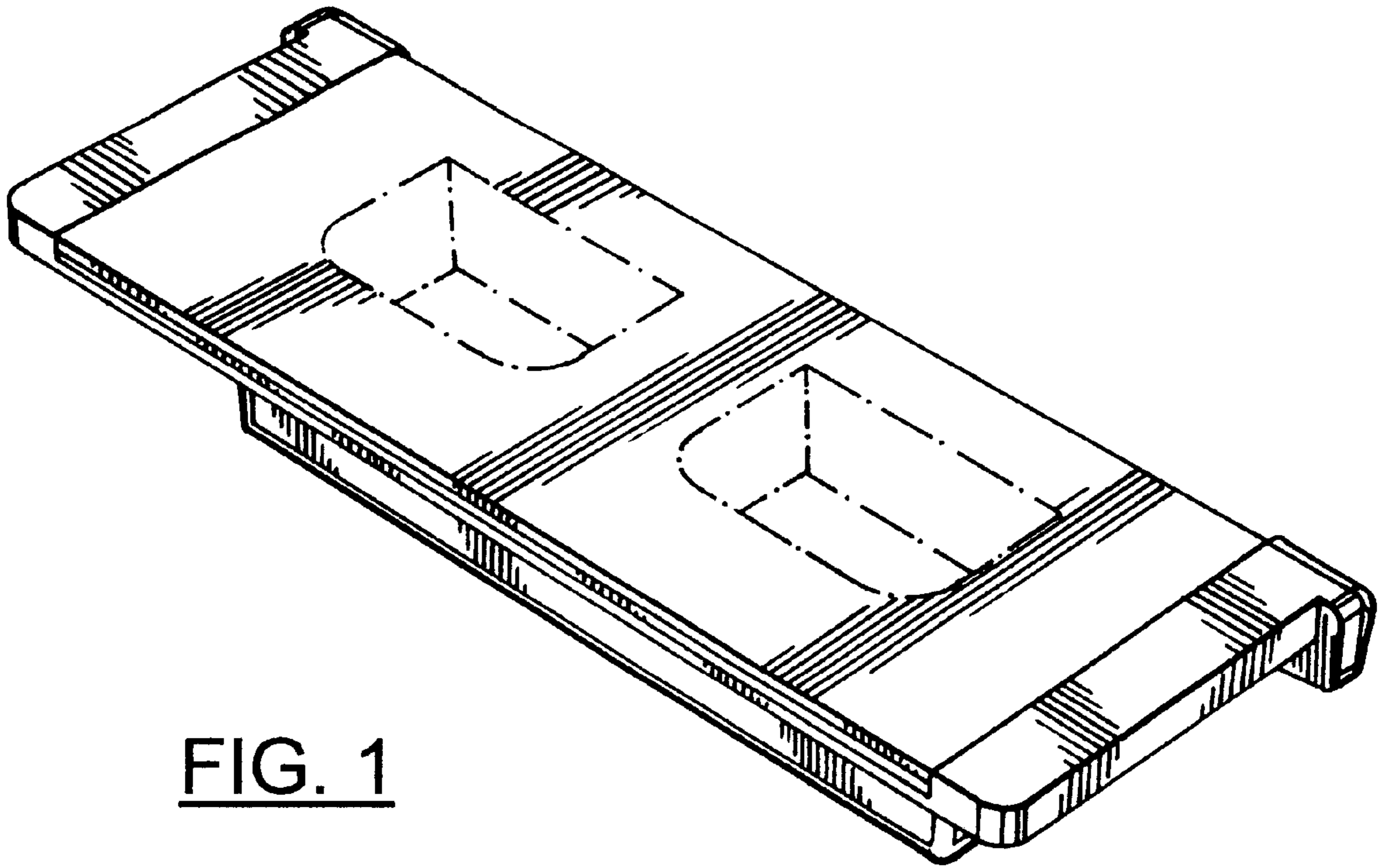

FIG. 1

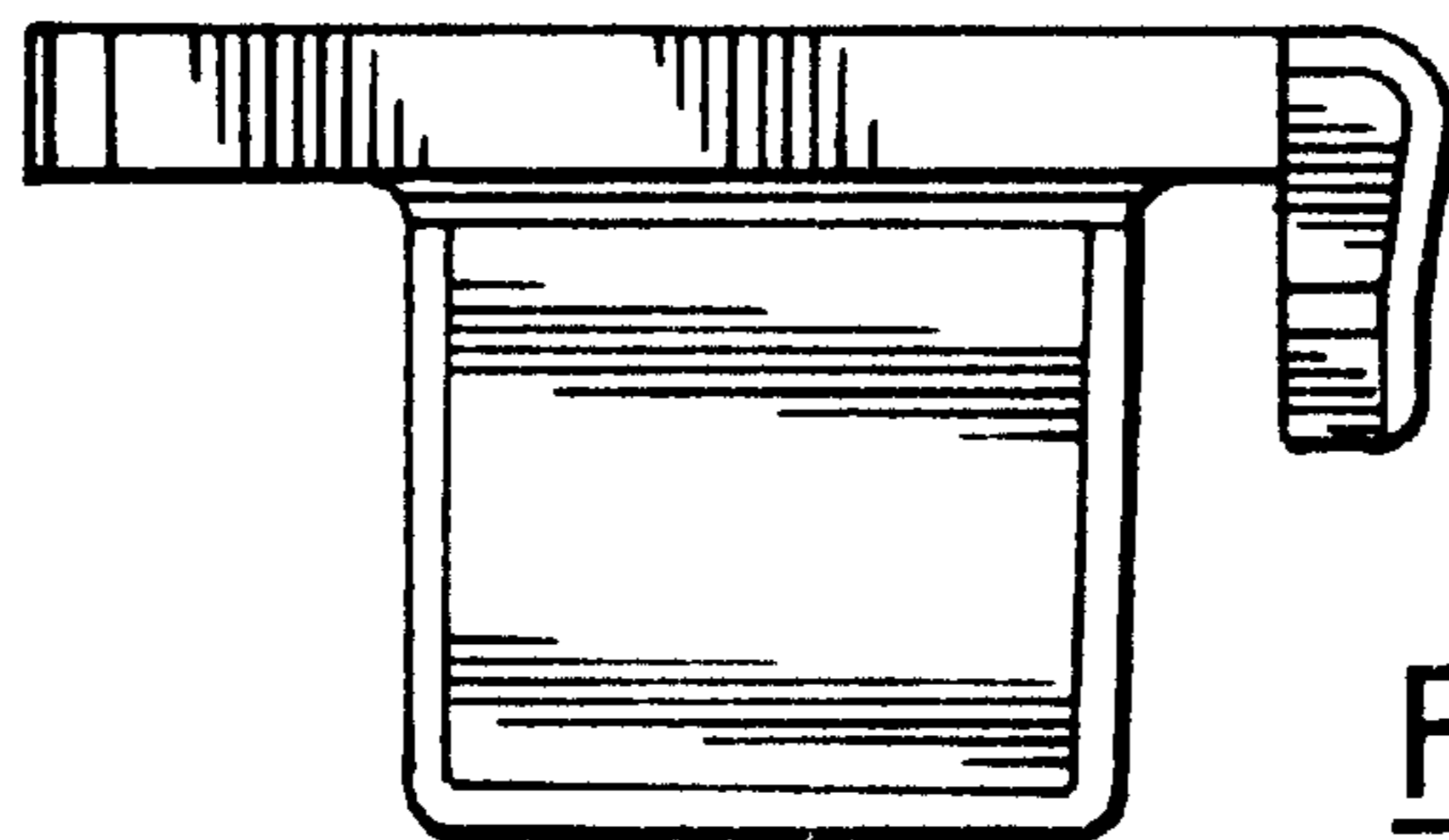

FIG. 2

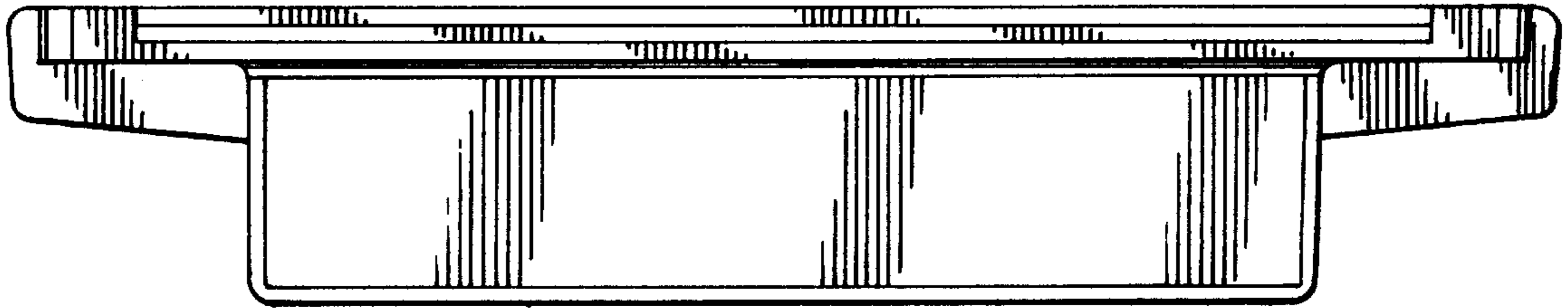

FIG. 3

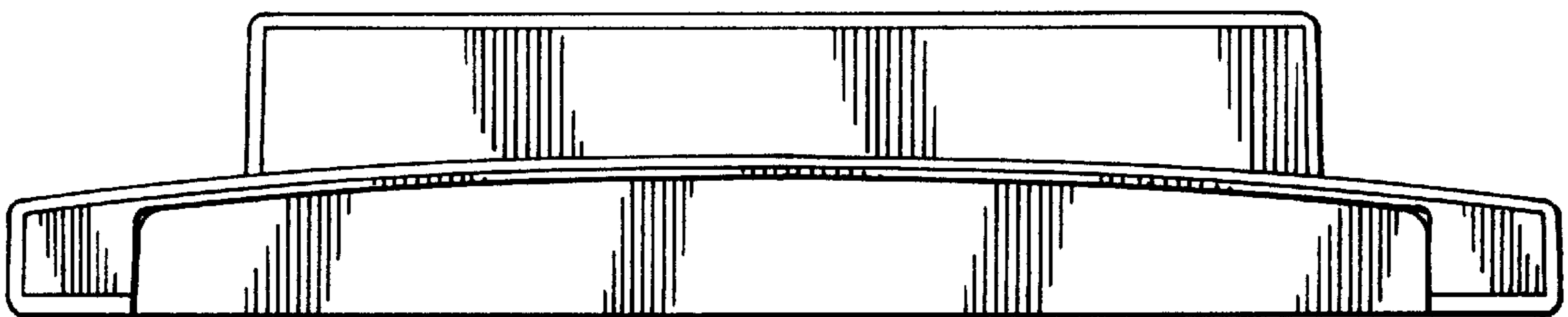

FIG. 4

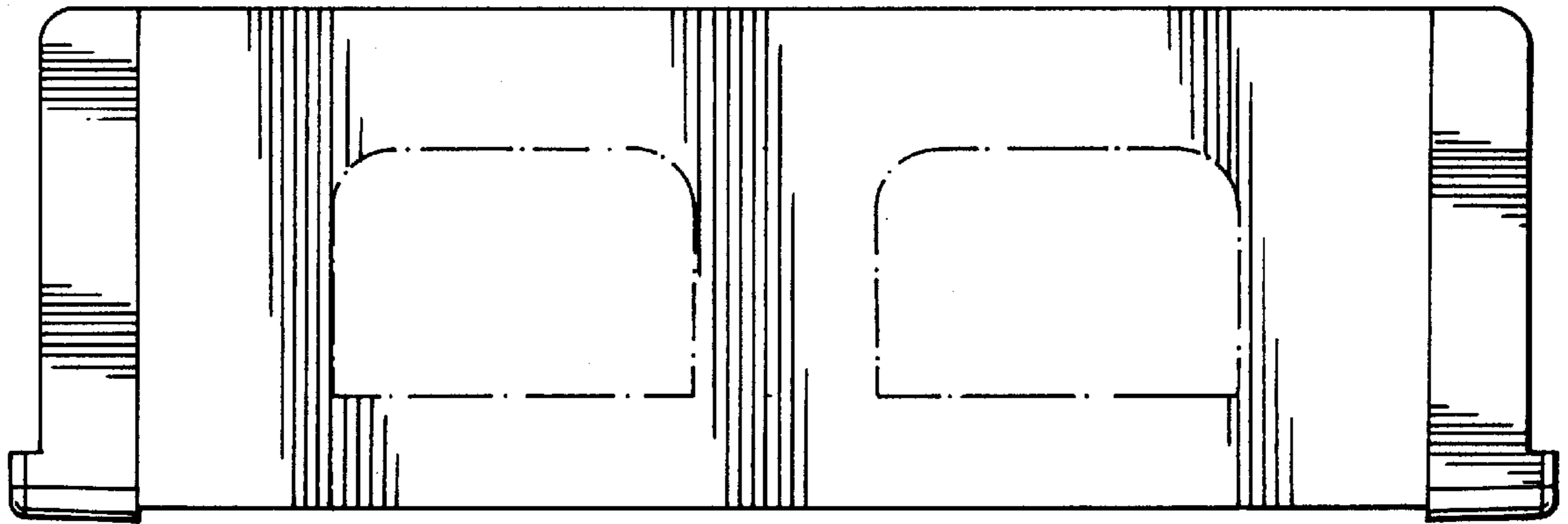

FIG. 5

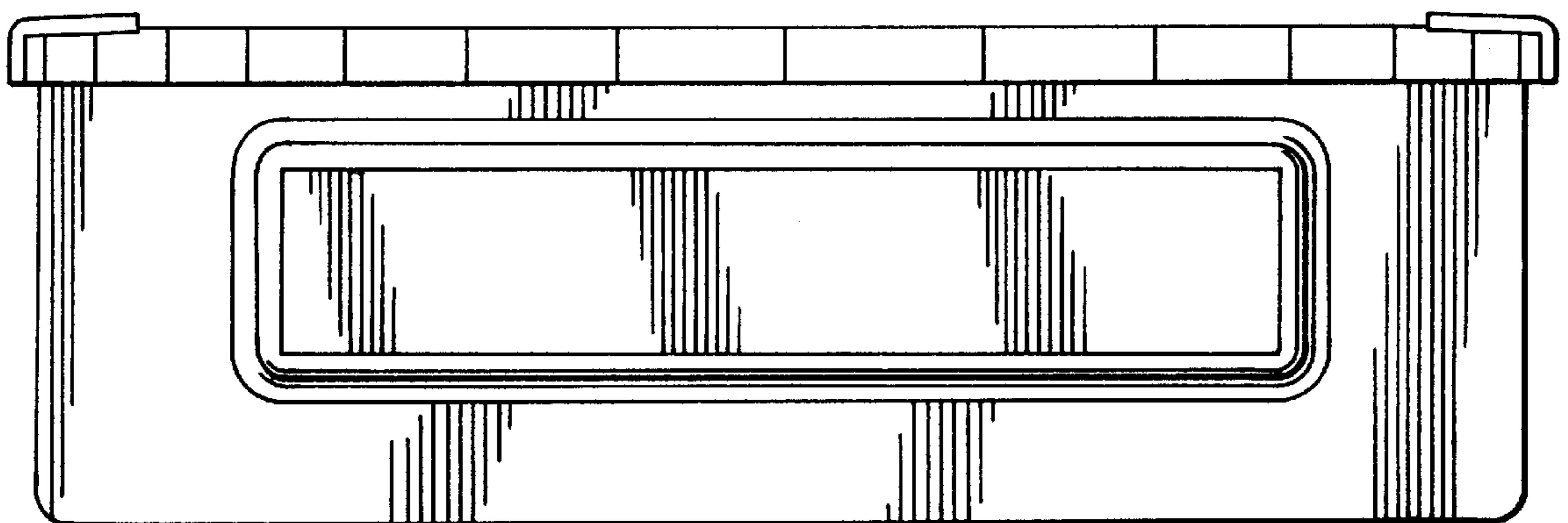

FIG. 6

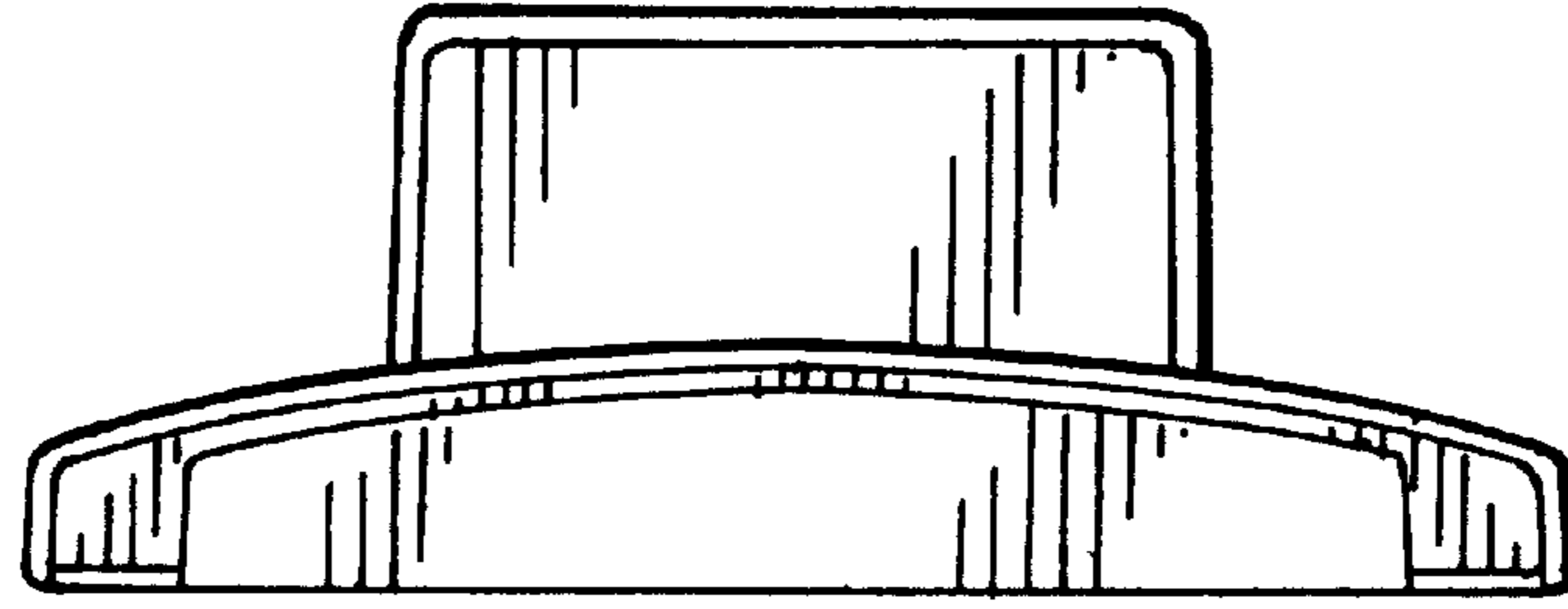

FIG. 9

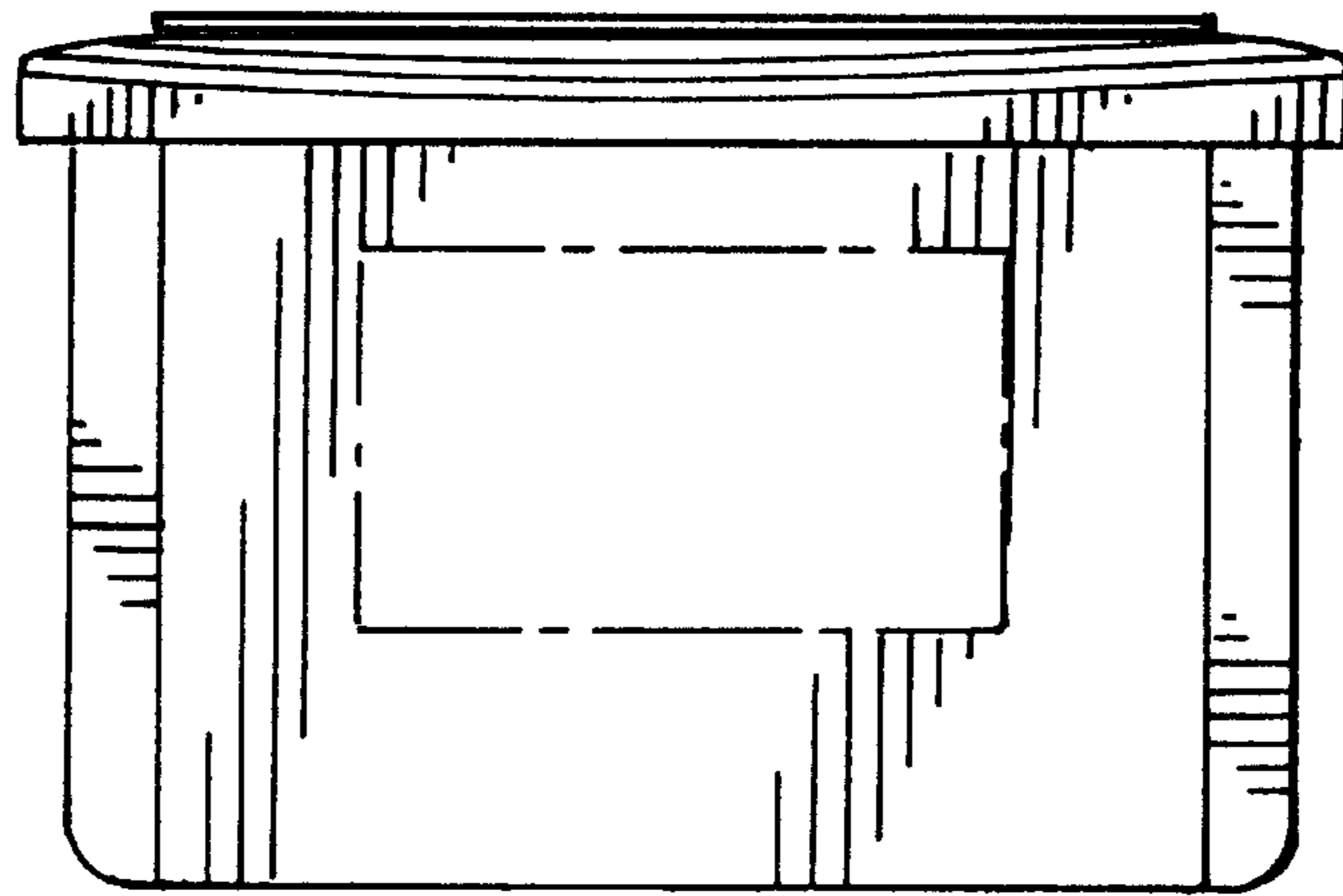

FIG. 8

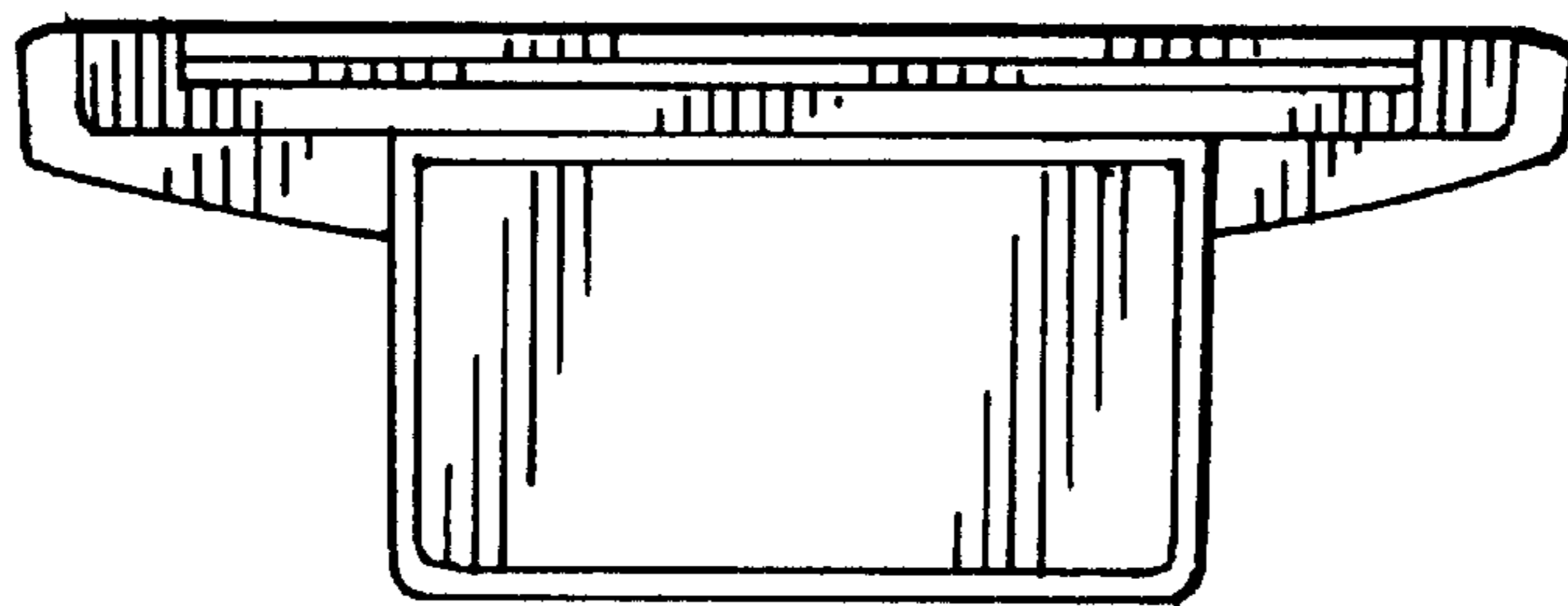

FIG. 7

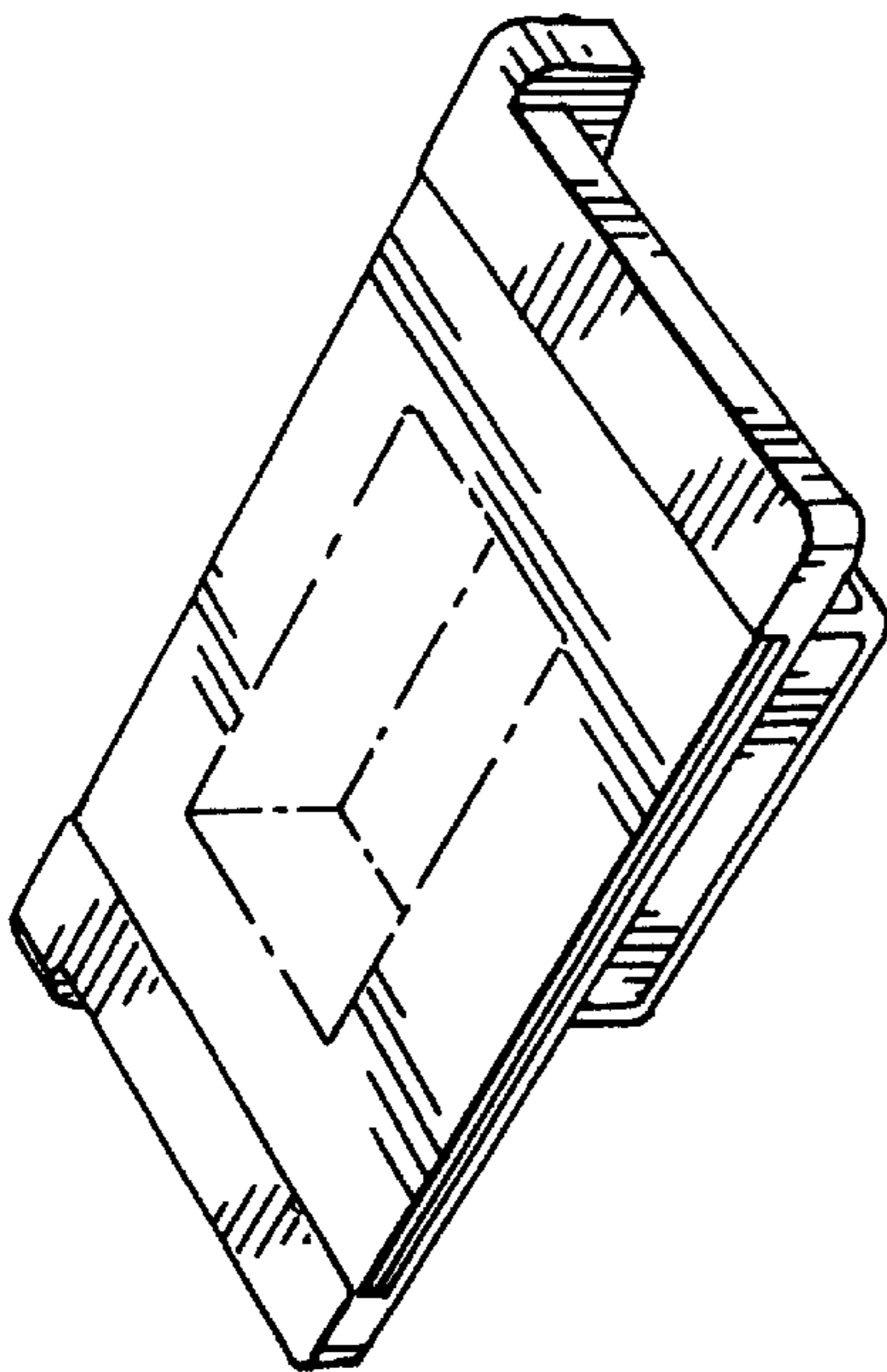

FIG. 10

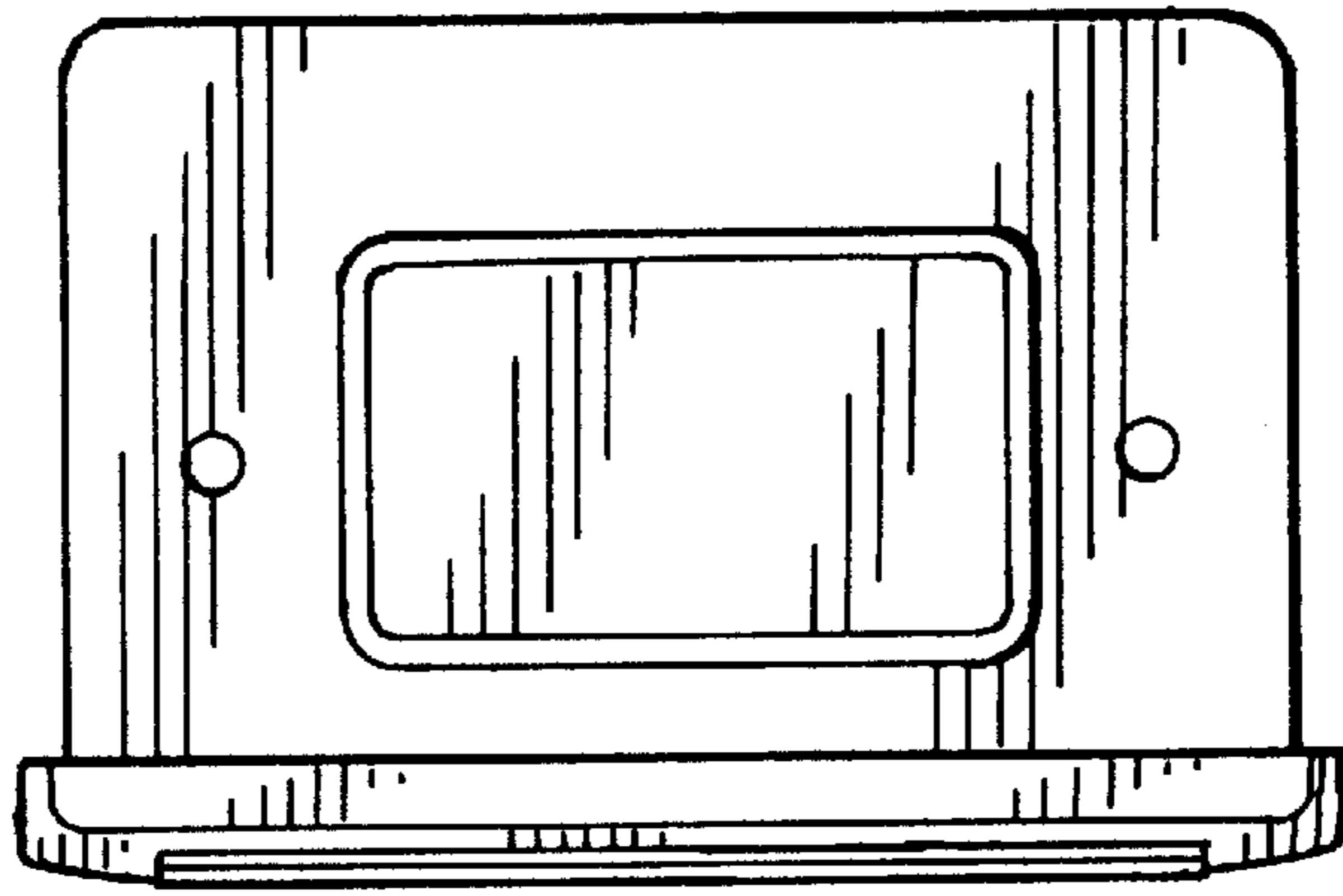

FIG. 12

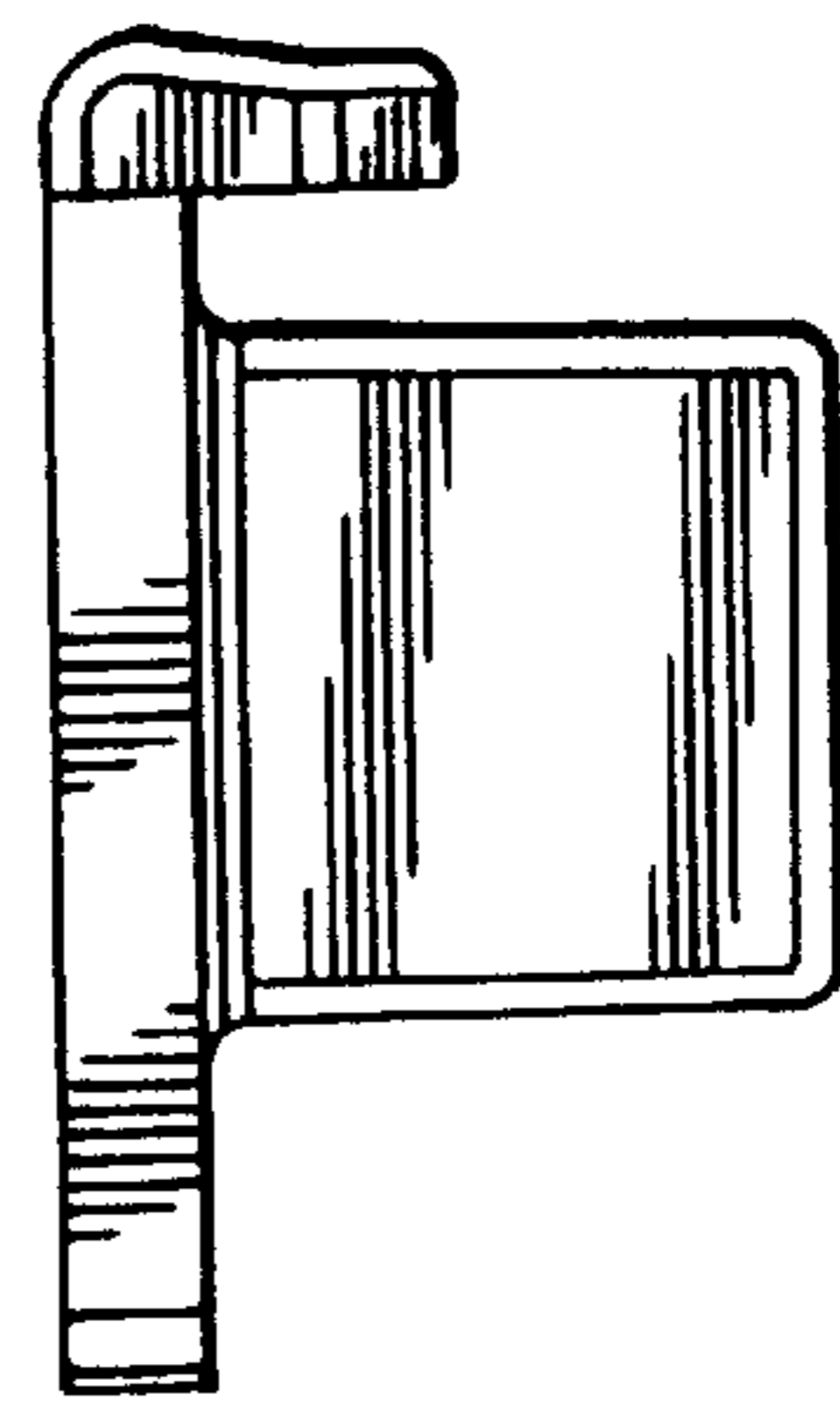

FIG. 11