



US00D452726B1

(12) **United States Design Patent**
Tsai

(10) **Patent No.:** **US D452,726 S**

(45) **Date of Patent:** **** Jan. 1, 2002**

(54) **PUMP**

(76) **Inventor:** **Long-Po Tsai**, 4Fl., No. 46, Lane 50,
Ming-Tsu Rd., Chu-Wei Li, Tan-Shui
Chen, Taipei Hsien (TW)

(**) **Term:** **14 Years**

(21) **Appl. No.:** **29/130,155**

(22) **Filed:** **Sep. 29, 2000**

(51) **LOC (7) Cl.** **15-01**

(52) **U.S. Cl.** **D23/231**

(58) **Field of Search** D15/7-9; D23/231,
D23/232; 92/15, 58, 128; 417/456

(56) **References Cited**

U.S. PATENT DOCUMENTS

785,154 A	*	3/1905	Cordeau	92/15
1,511,649 A	*	10/1924	Wentzell	417/554
1,593,356 A	*	8/1926	Hughes	417/554
D140,232 S	*	2/1945	Russell	D23/231
D150,097 S	*	6/1948	Russell	D23/231

D287,531 S	*	12/1986	Evans	D23/231
D321,037 S	*	10/1991	Furusawa	D23/231
D343,397 S	*	1/1994	Wang	D15/7
D351,896 S	*	10/1994	Sundheim et al.	D23/231
5,433,136 A	*	7/1995	Lung-ho	92/58

* cited by examiner

Primary Examiner—Ralf Seifert

(74) *Attorney, Agent, or Firm*—Bacon & Thomas, PLLC

(57) **CLAIM**

The ornamental design for a pump, as shown.

DESCRIPTION

FIG. 1 is a perspective view of a pump, showing my new design;

FIG. 2 is a front elevational view thereof;

FIG. 3 is a rear elevational view thereof;

FIG. 4 is a left elevational view thereof;

FIG. 5 is a right elevational view thereof;

FIG. 6 is top plan view thereof; and,

FIG. 7 is a bottom plan view thereof.

1 Claim, 6 Drawing Sheets

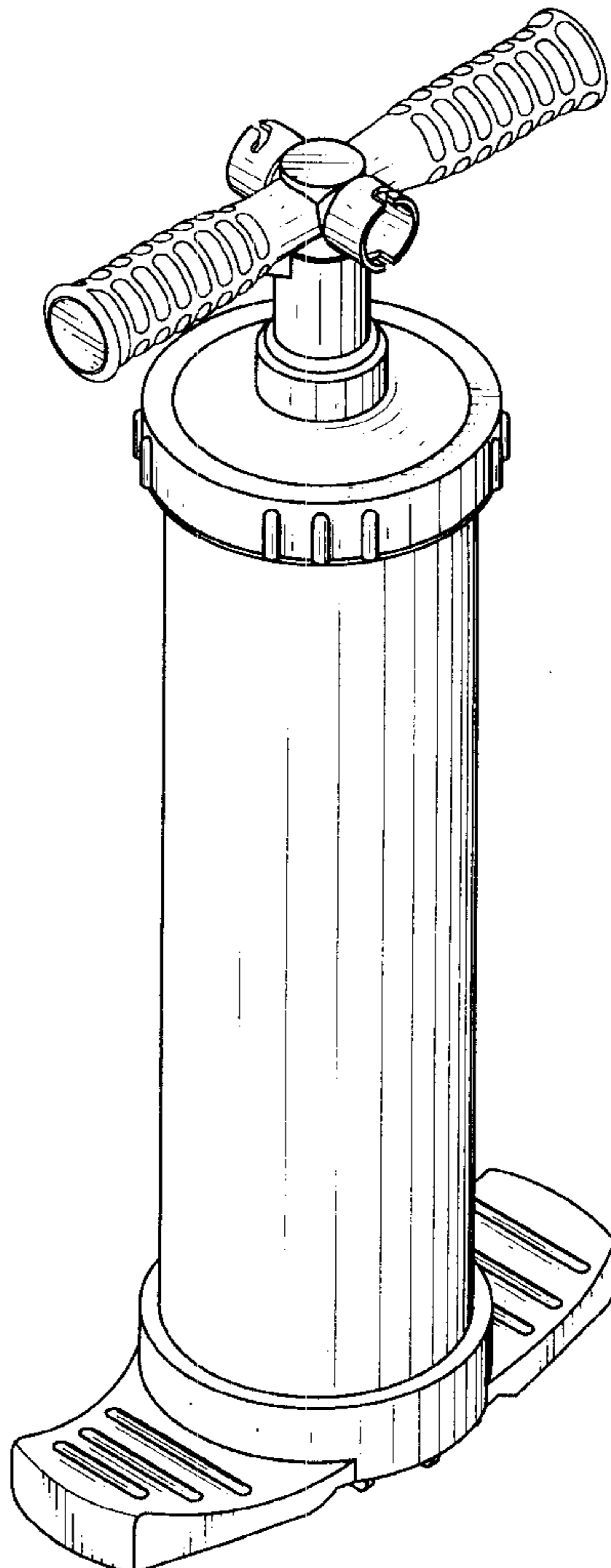

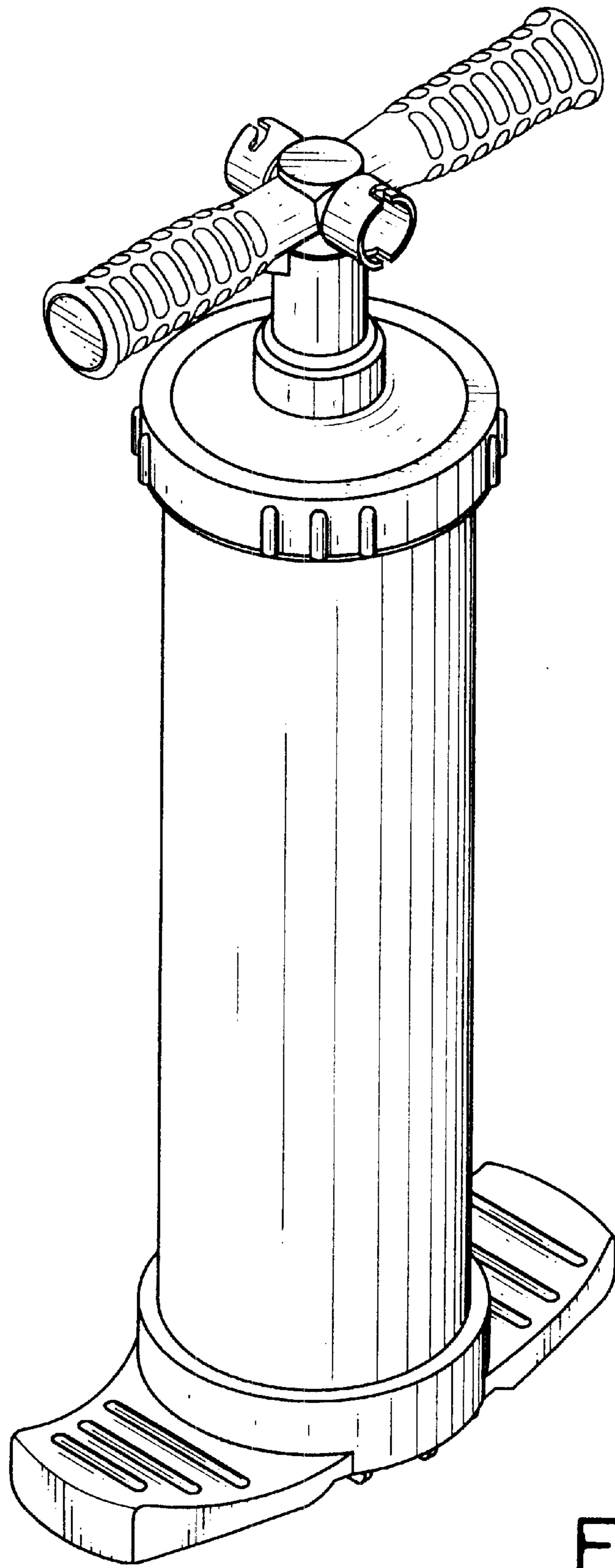

FIG. 1

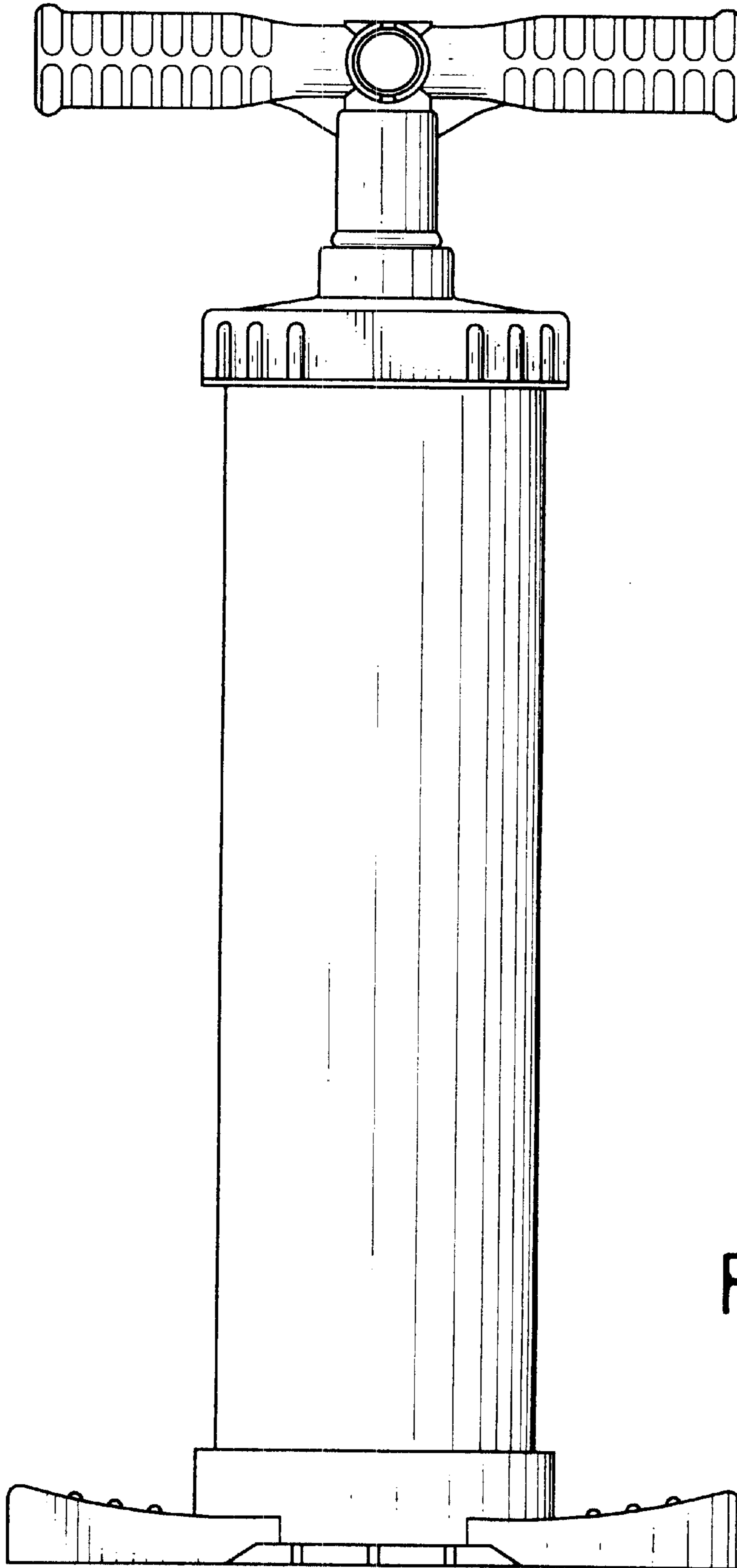

FIG.2

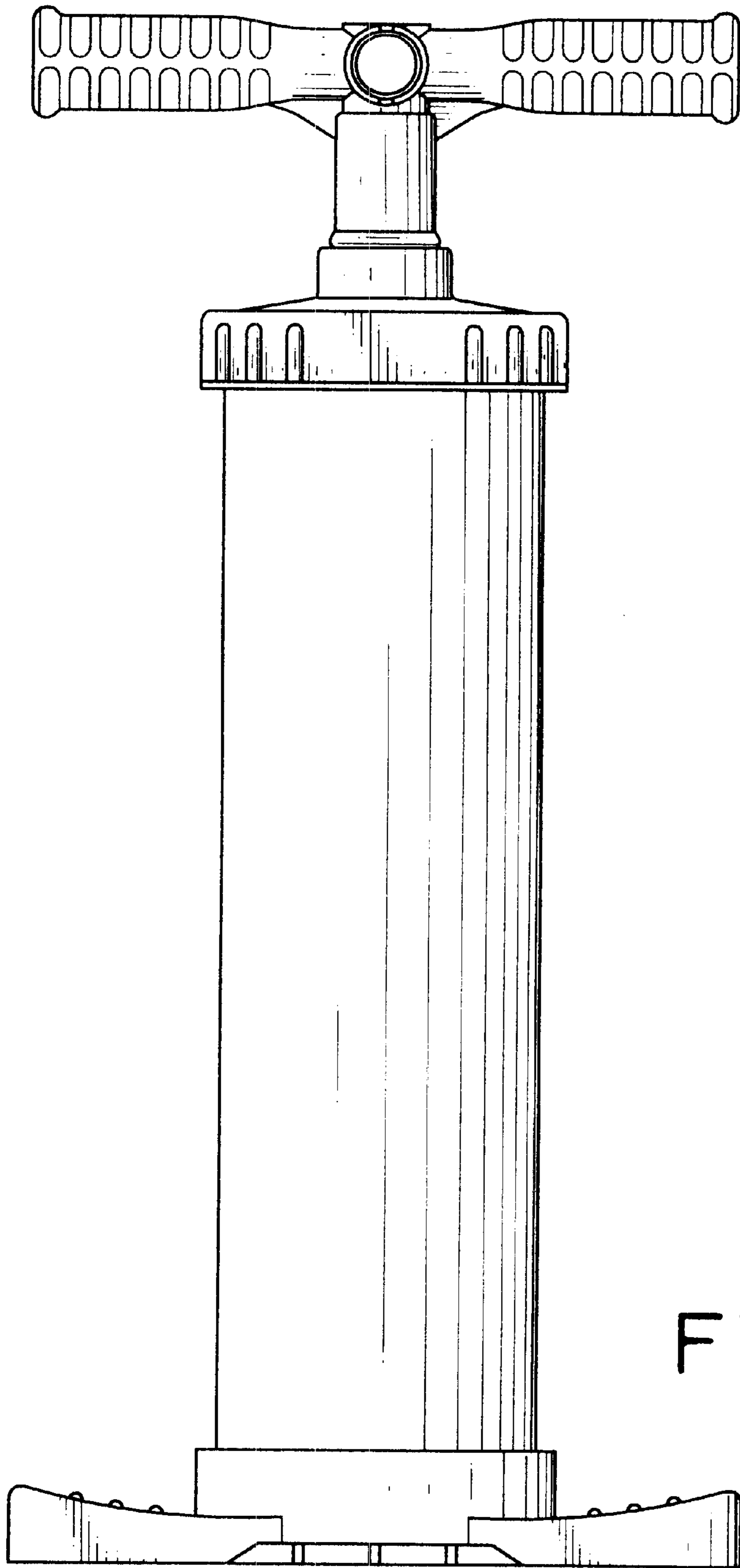

FIG. 3

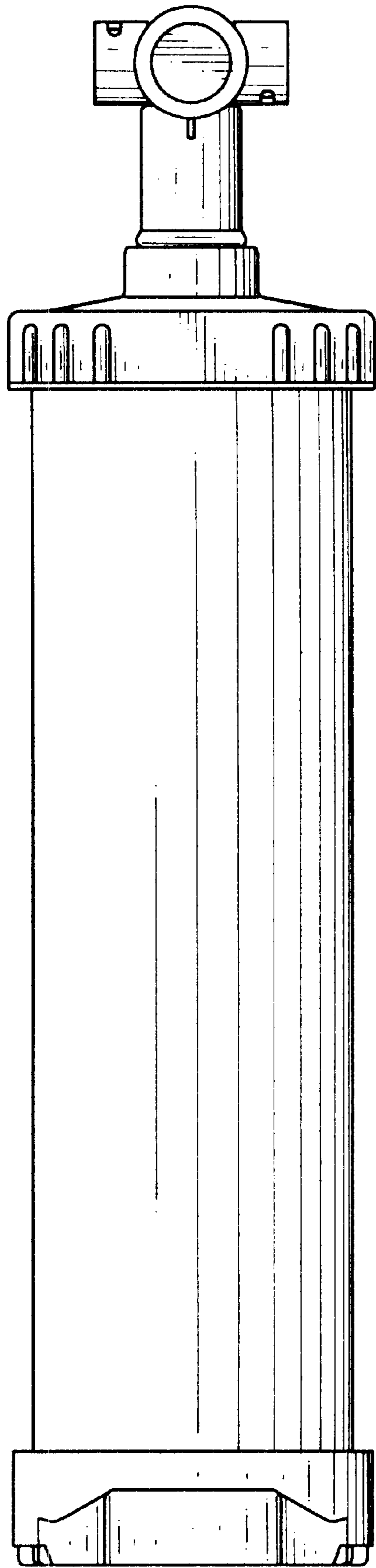

FIG.4

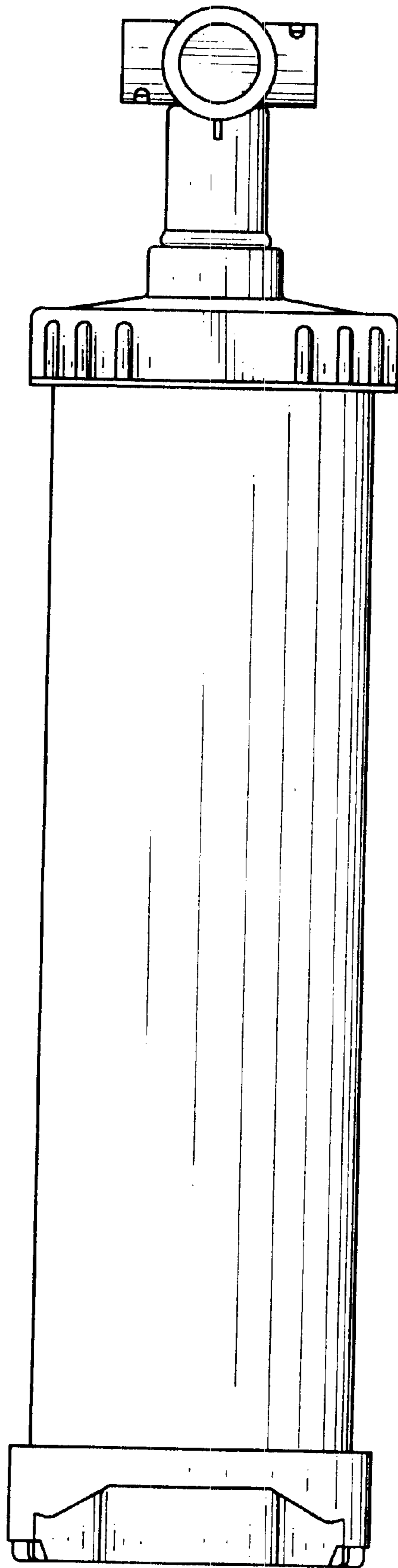

FIG. 5

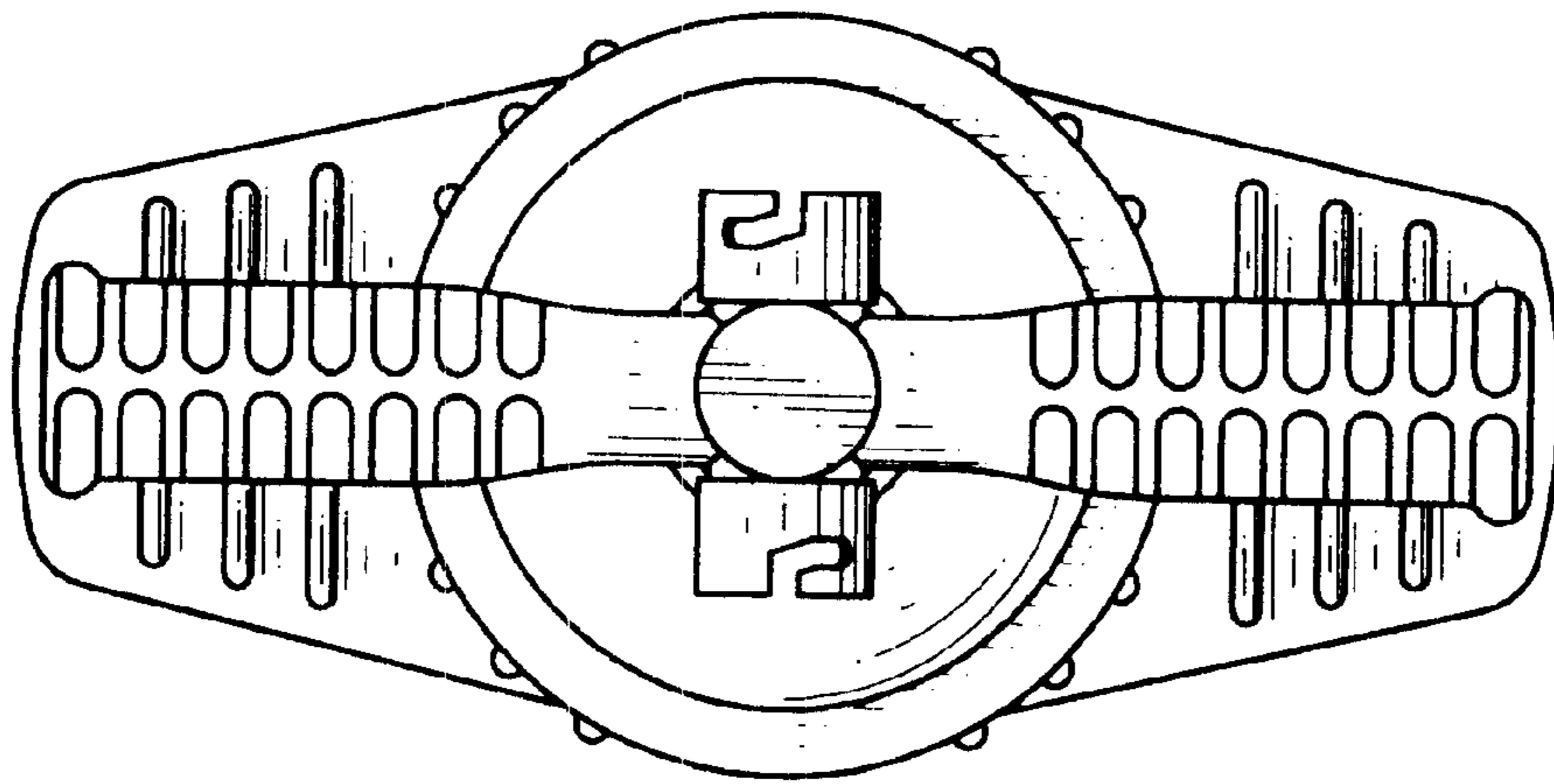

FIG. 6

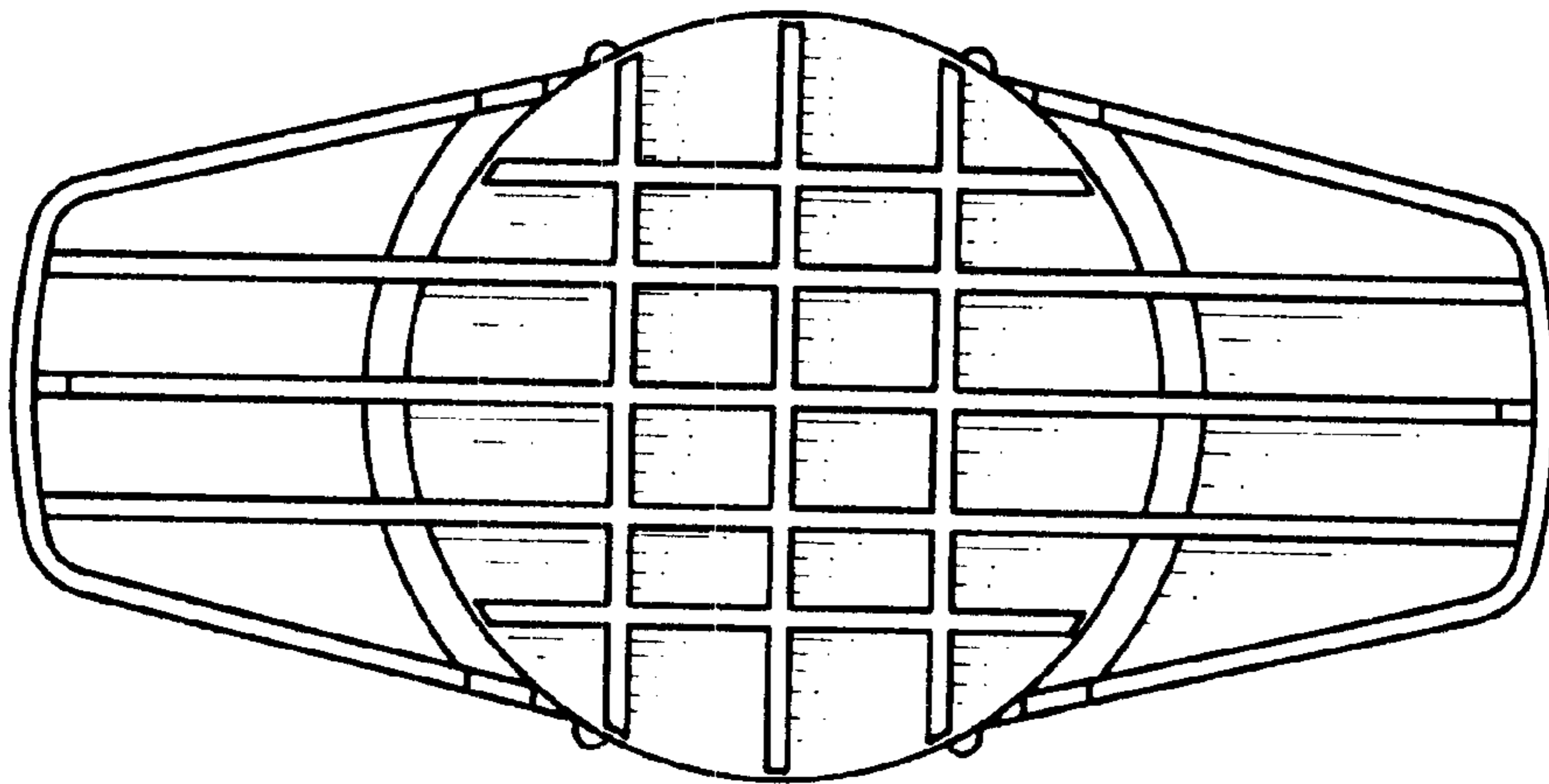

FIG. 7