



US00D452701B1

(12) **United States Design Patent**
Kusanagi et al.

(10) **Patent No.:** **US D452,701 S**
(45) **Date of Patent:** **** Jan. 1, 2002**

(54) **LASER BEAM PRINTER**

(75) Inventors: **Takashi Kusanagi**, Akishima; **Akihisa Shiozaki**, Tokyo, both of (JP)

(73) Assignee: **Canon Kabushiki Kaisha**, Tokyo (JP)

(**) Term: **14 Years**

(21) Appl. No.: **29/119,609**

(22) Filed: **Mar. 6, 2000**

(30) **Foreign Application Priority Data**

Sep. 7, 1999 (JP) 11-24051

(51) **LOC (7) Cl.** **18-02**

(52) **U.S. Cl.** **D18/53**

(58) **Field of Search** D18/50-55, 36,
D18/39; 400/613.1-613.4, 613, 690.1-690.4,
691-694; 399/107, 367, 391, 399

(56) **References Cited**

U.S. PATENT DOCUMENTS

- D344,286 S * 2/1994 Sugimoto D18/55
- D363,713 S * 10/1995 Kanari et al. D14/118
- D375,974 S * 11/1996 Kogoh et al. D18/53

- D377,369 S * 1/1997 Kogoh et al. D18/53
- D407,741 S 4/1999 Kusanagi D18/55
- D436,371 S * 1/2001 Shimamura D18/50

* cited by examiner

Primary Examiner—Melody N. Brown

(74) *Attorney, Agent, or Firm*—Fitzpatrick, Cella, Harper & Scinto

(57) **CLAIM**

The ornamental design for a laser beam printer, as shown and described.

DESCRIPTION

FIG. 1 is a front view of a laser beam printer showing our new design;

FIG. 2 is a rear view thereof;

FIG. 3 is a top plan view thereof;

FIG. 4 is a bottom plan view thereof;

FIG. 5 is a left side view thereof;

FIG. 6 is a right side view thereof; and,

FIG. 7 is a perspective view thereof.

The portions of the printer shown in broken lines are for illustrative purposes only and form no part of the claimed design.

1 Claim, 7 Drawing Sheets

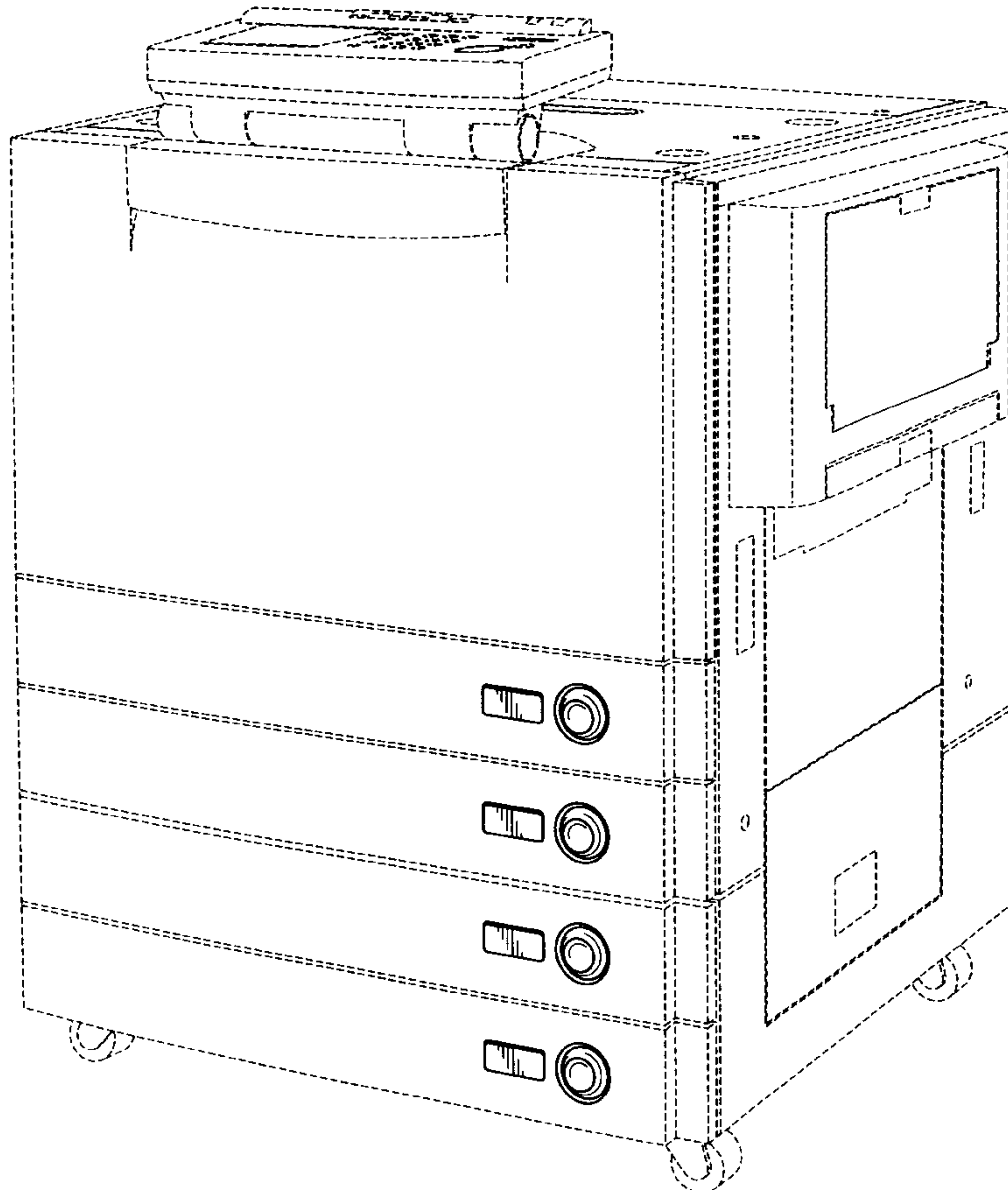

FIG. 1

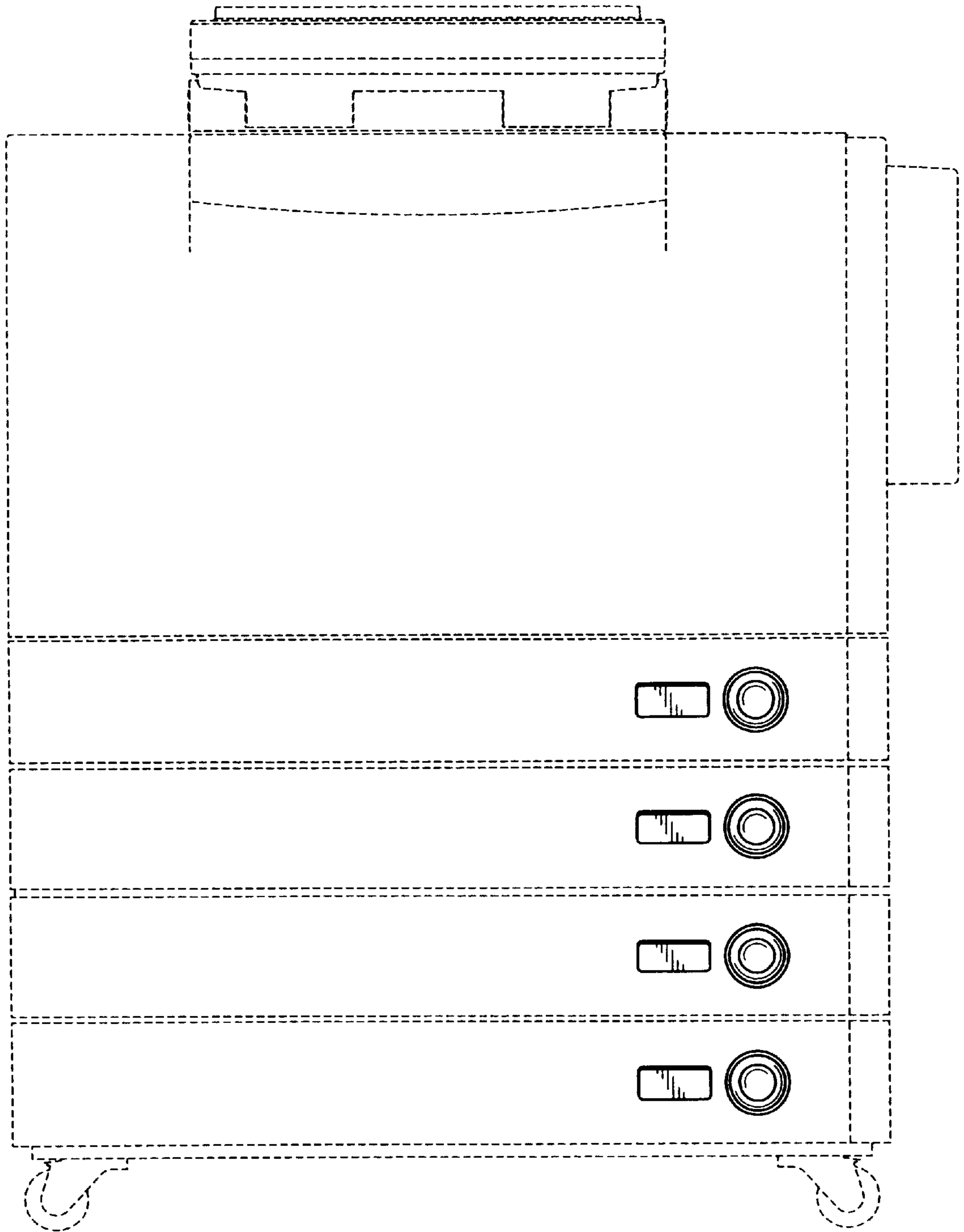

FIG. 2

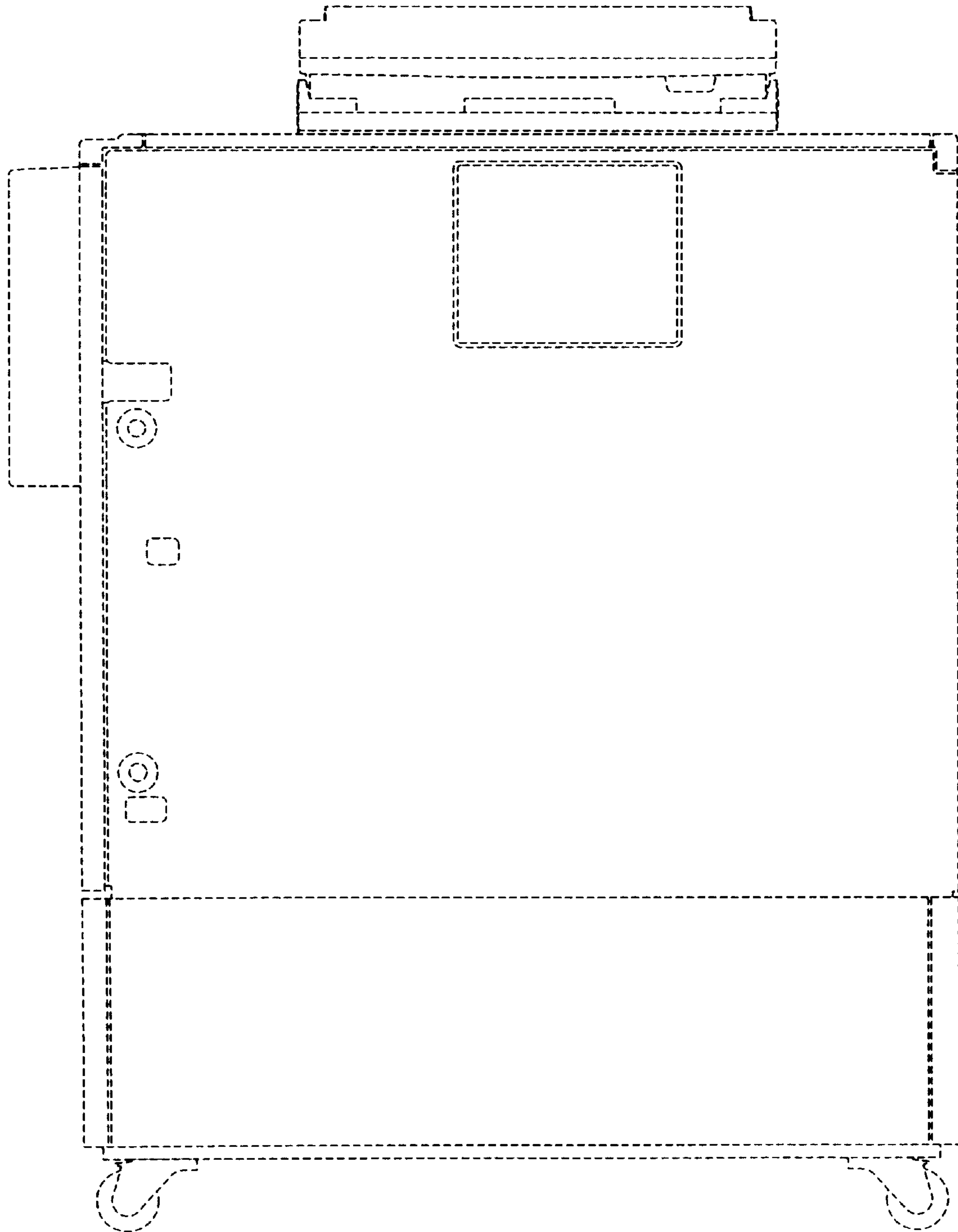

FIG. 3

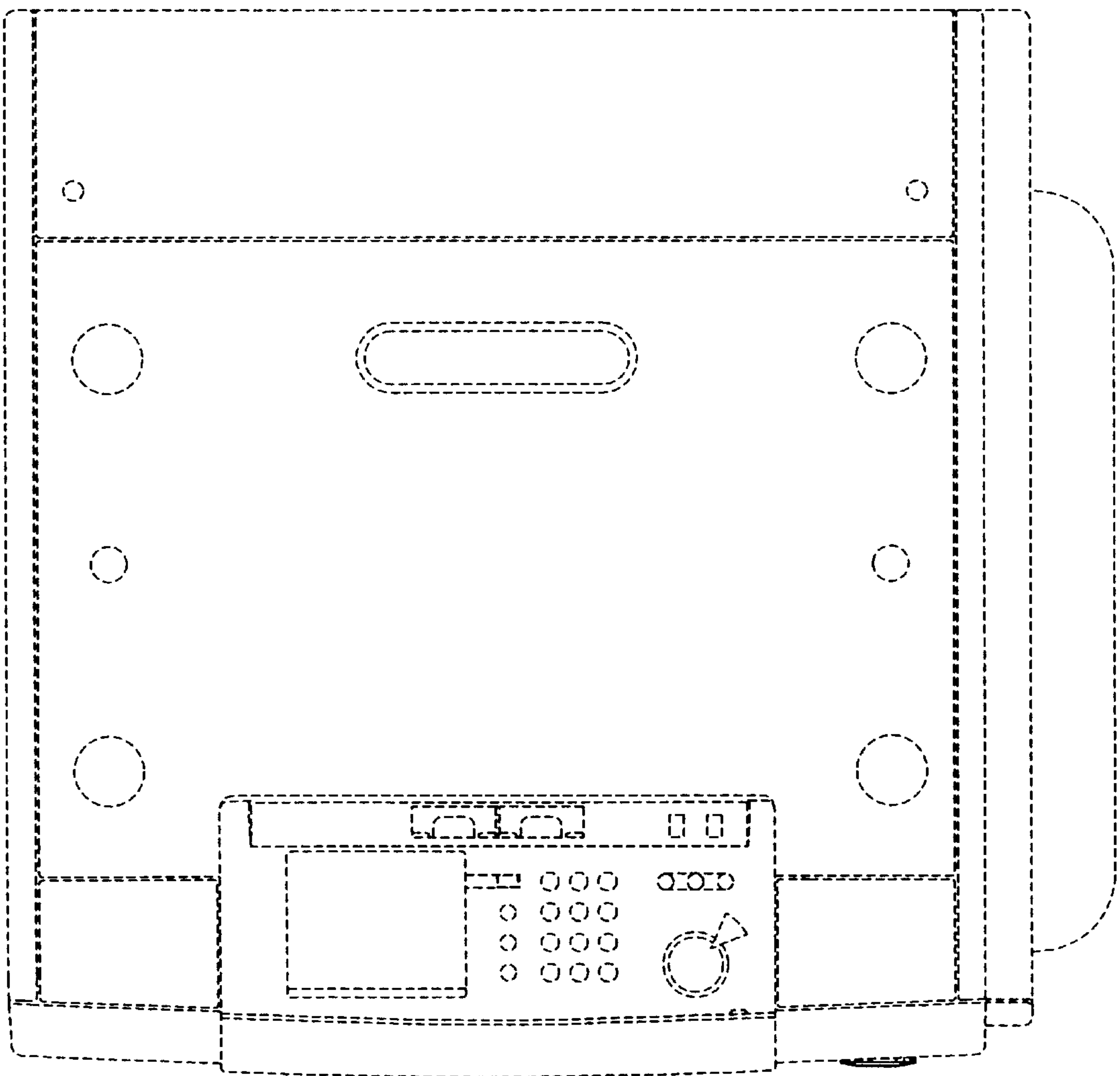

FIG. 4

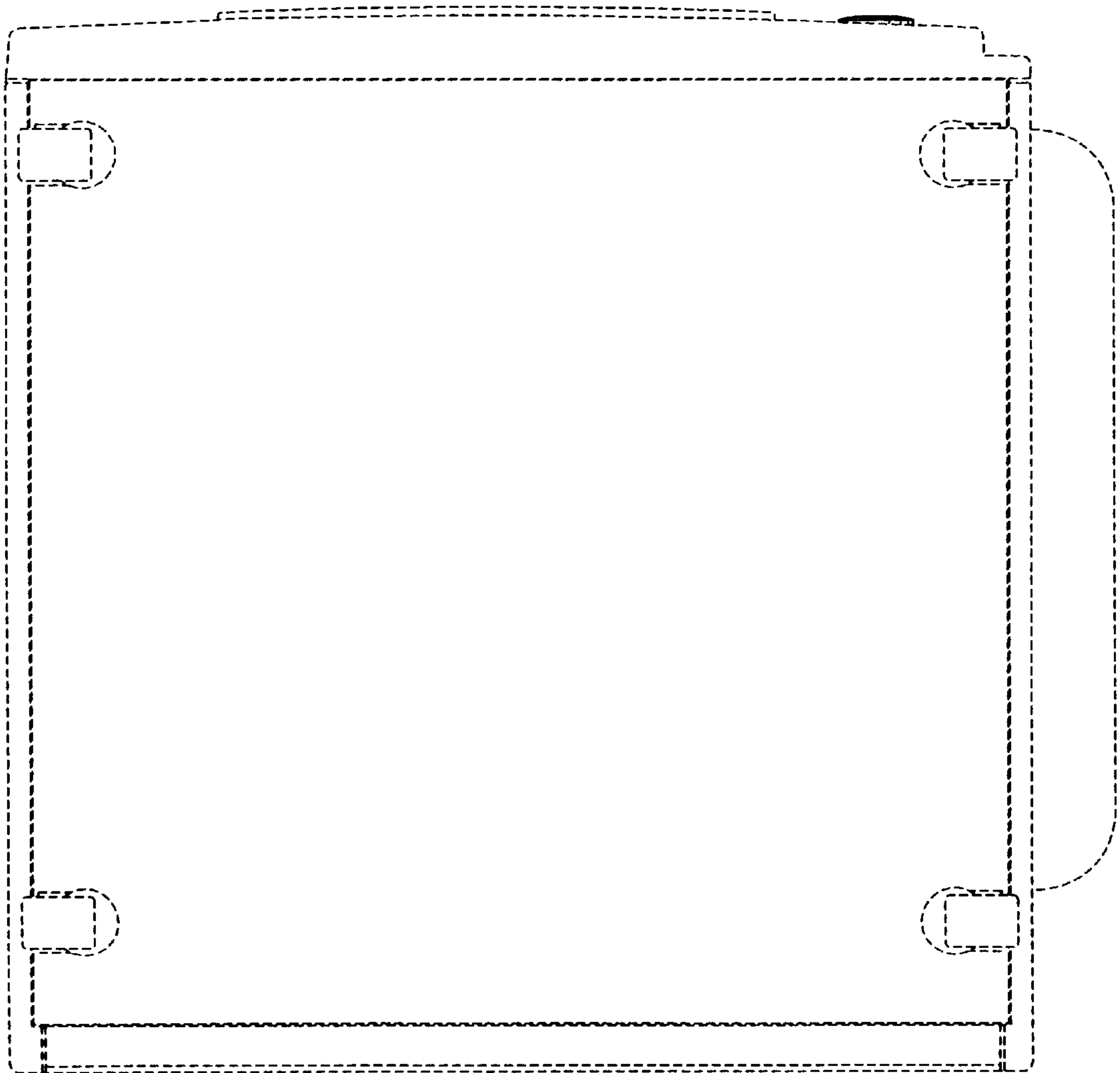

FIG. 5

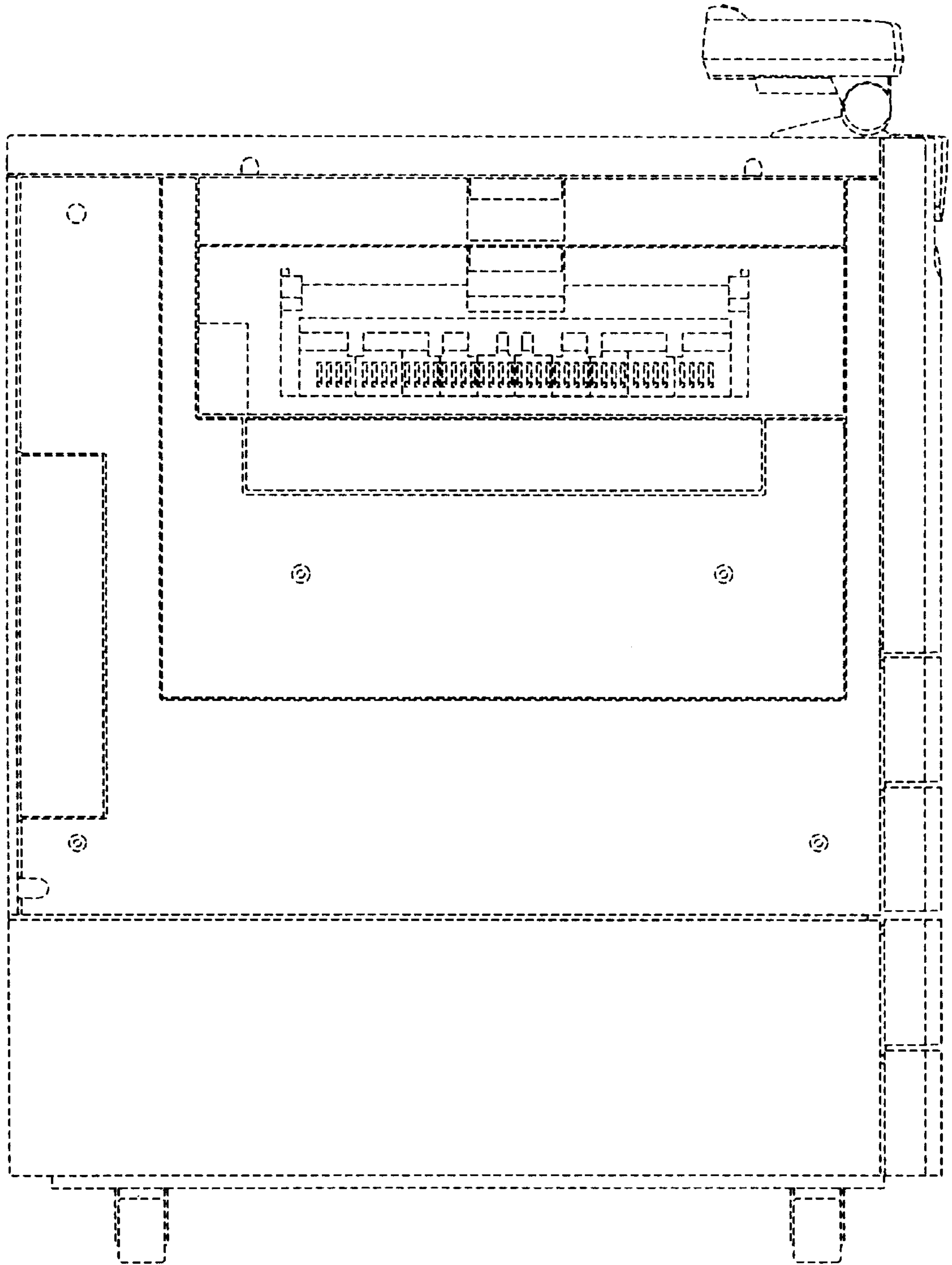

FIG. 6

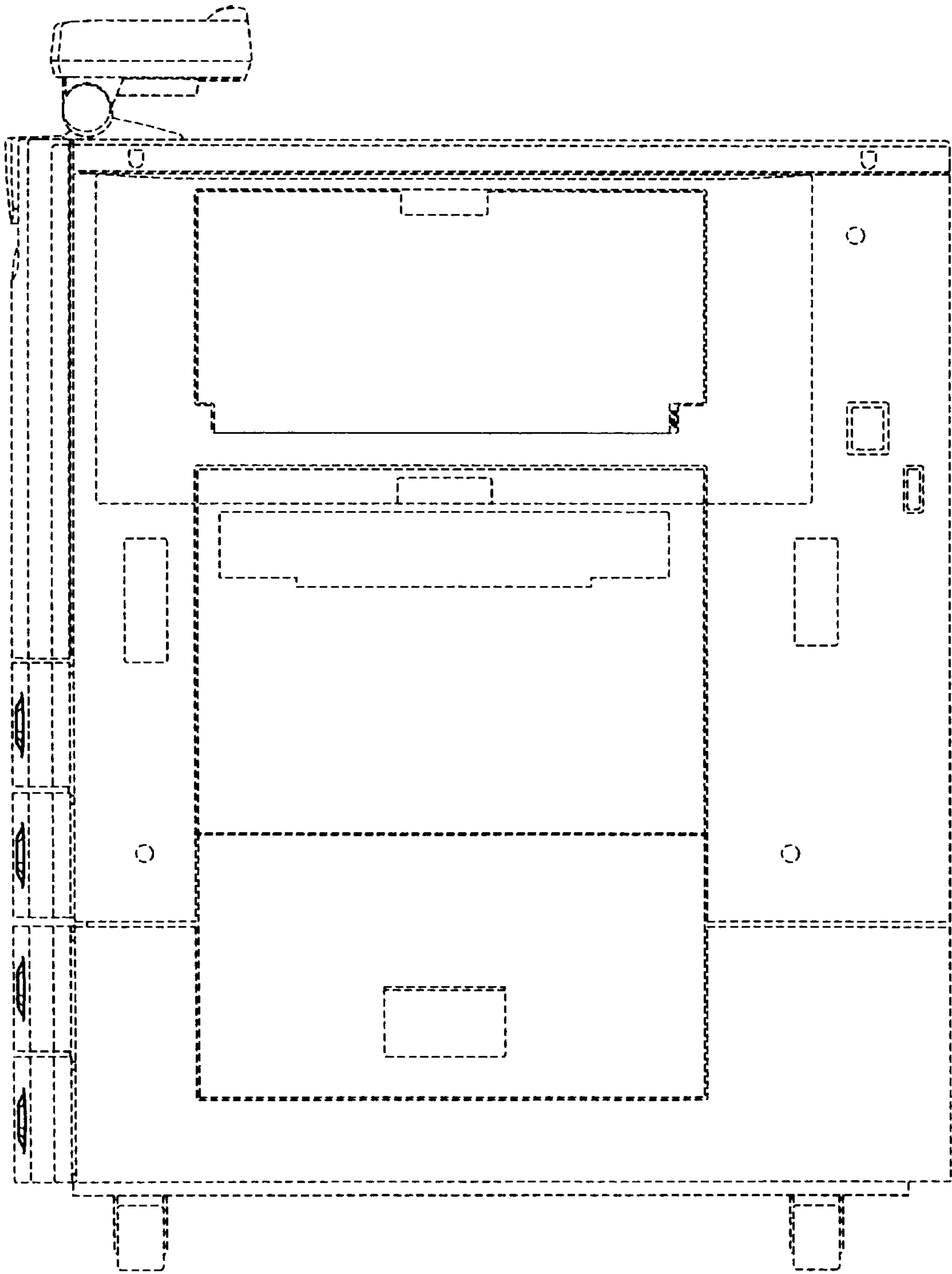

FIG. 7

