



US00D452698B1

(12) **United States Design Patent**
Shinano

(10) **Patent No.:** **US D452,698 S**

(45) **Date of Patent:** **** Jan. 1, 2002**

(54) **PORTABLE PRINTER**

(75) Inventor: **Toru Shinano, Yokohama (JP)**

(73) Assignee: **Canon Kabushiki Kaisha, Tokyo (JP)**

(**) Term: **14 Years**

(21) Appl. No.: **29/138,190**

(22) Filed: **Mar. 9, 2001**

(30) **Foreign Application Priority Data**

Sep. 12, 2000 (JP) 12-025402

(51) **LOC (7) Cl.** **14-02**

(52) **U.S. Cl.** **D18/14; D18/50**

(58) **Field of Search** D18/50, 54-55,
D18/36-39, 12, 56, 43-44, 14; 400/613,
613.1-613.4, 691-694, 690.1-690.4, 236.1,
207-208, 234, 193, 196, 242, 246, 236

(56) **References Cited**

U.S. PATENT DOCUMENTS

3,425,531	A	*	2/1969	Fuld	400/242
4,113,750	A	*	9/1978	Isobe	206/388
D322,982	S	*	1/1992	Tashiro	D18/54
D323,848	S	*	2/1992	Shigemura	D18/14
D329,862	S	*	9/1992	Watanabe et al.	D16/208
D334,402	S	*	3/1993	Matsumoto et al.	D18/50
5,264,949	A	*	11/1993	Stemmler	358/474

D345,353	S	*	3/1994	Dietrich	D14/118
D361,084	S	*	8/1995	Yamanaka et al.	D18/50
5,439,303	A	*	8/1995	Alday	400/242
D364,639	S	*	11/1995	Tashiro	D18/50
5,499,877	A	*	3/1996	Sakanishi et al.	400/193
D373,791	S	*	9/1996	Nobata	D18/56
D375,981	S	*	11/1996	Takahata et al.	D21/324
D414,505	S	*	9/1999	Yatabe	D16/208
D440,246	S	*	4/2001	Yin	D18/50

* cited by examiner

Primary Examiner—Cathy Anne MacCormac

(74) *Attorney, Agent, or Firm*—Fitzpatrick, Cella, Harper & Scinto

(57) **CLAIM**

The ornamental design for a portable printer, as shown and described.

DESCRIPTION

FIG. 1 is a front view of a portable printer showing my new design;

FIG. 2 is a rear view thereof;

FIG. 3 is a top plan view thereof;

FIG. 4 is a bottom plan view thereof;

FIG. 5 is a left side view thereof;

FIG. 6 is a right side view thereof; and,

FIG. 7 is a perspective view thereof.

1 Claim, 2 Drawing Sheets

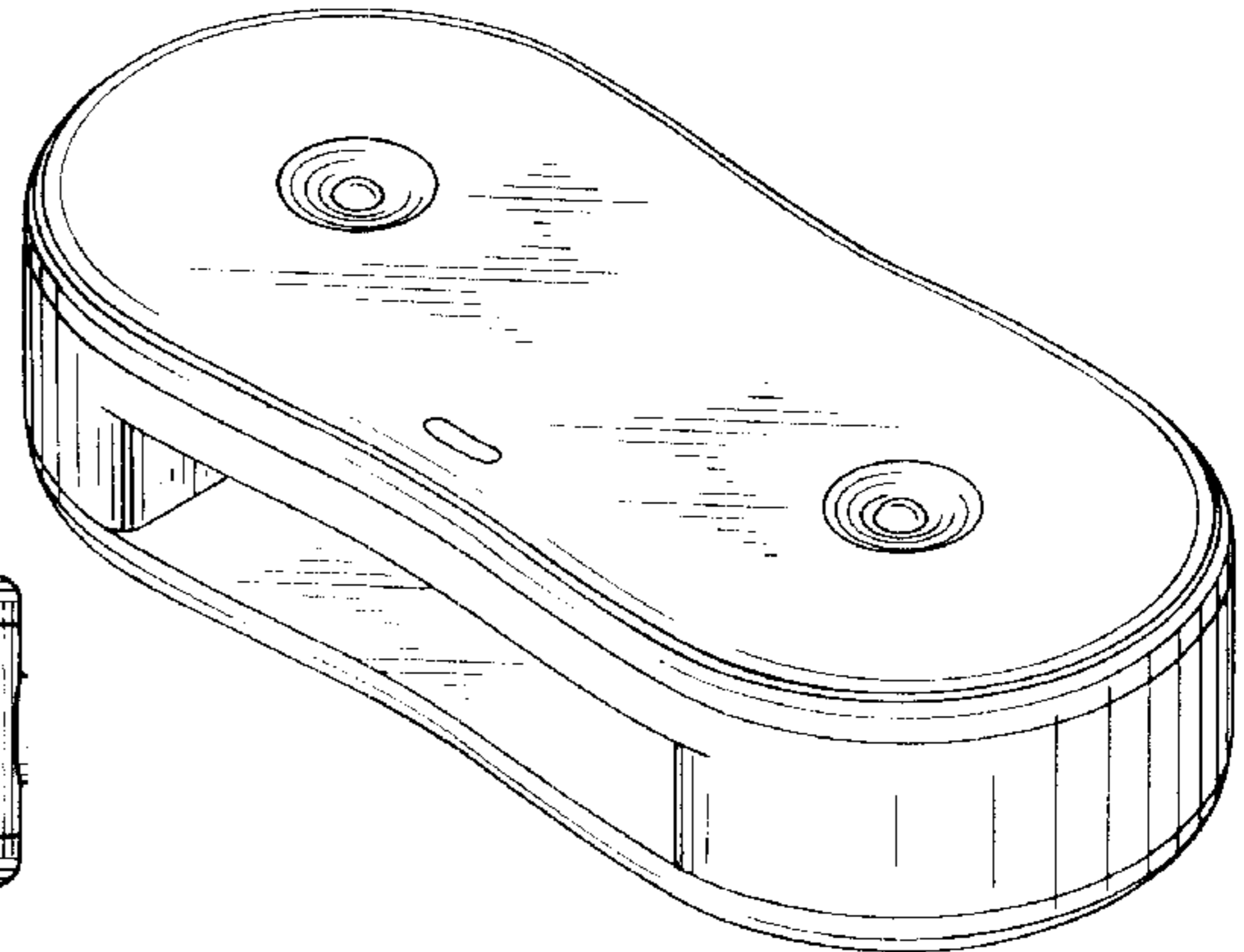
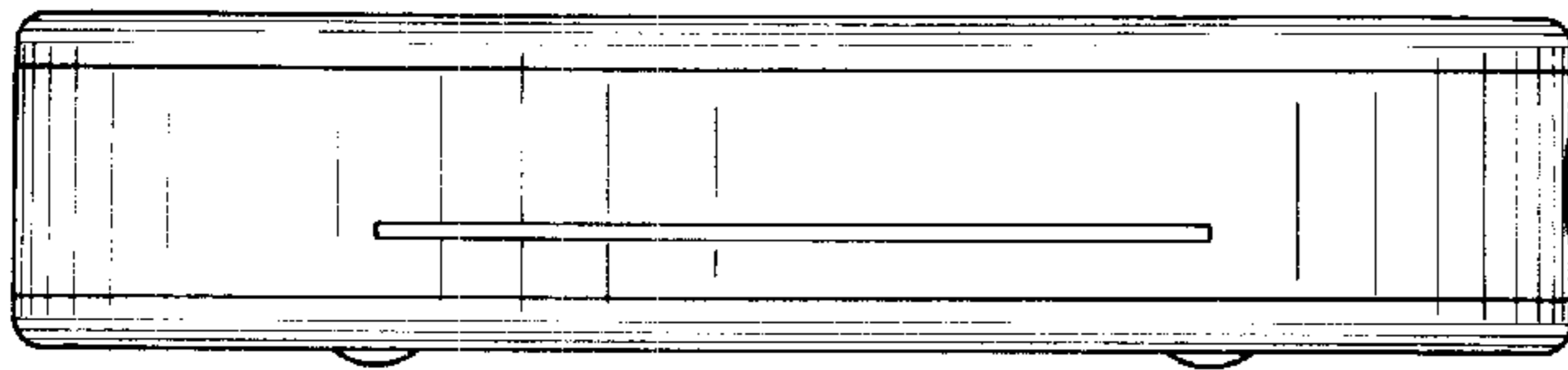

FIG. 1

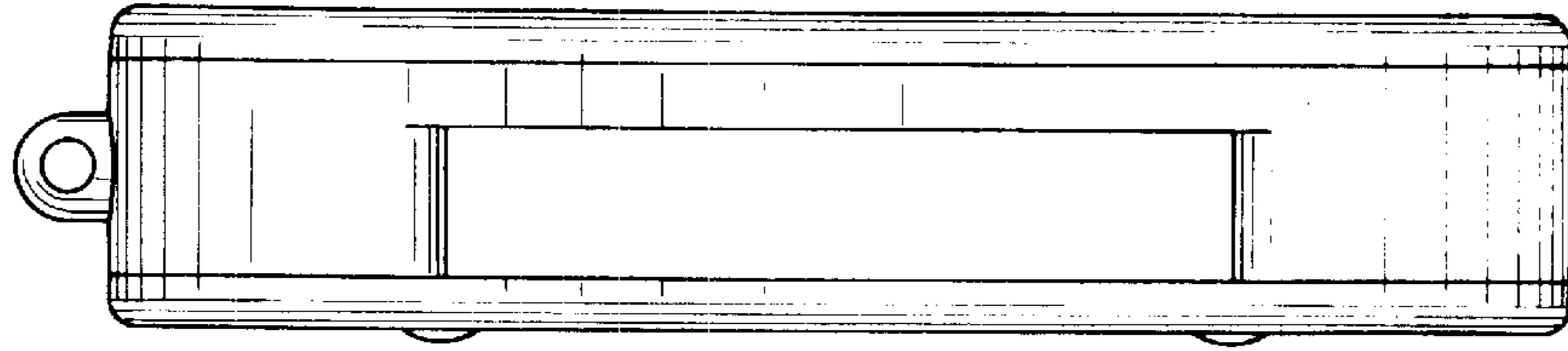

FIG. 2

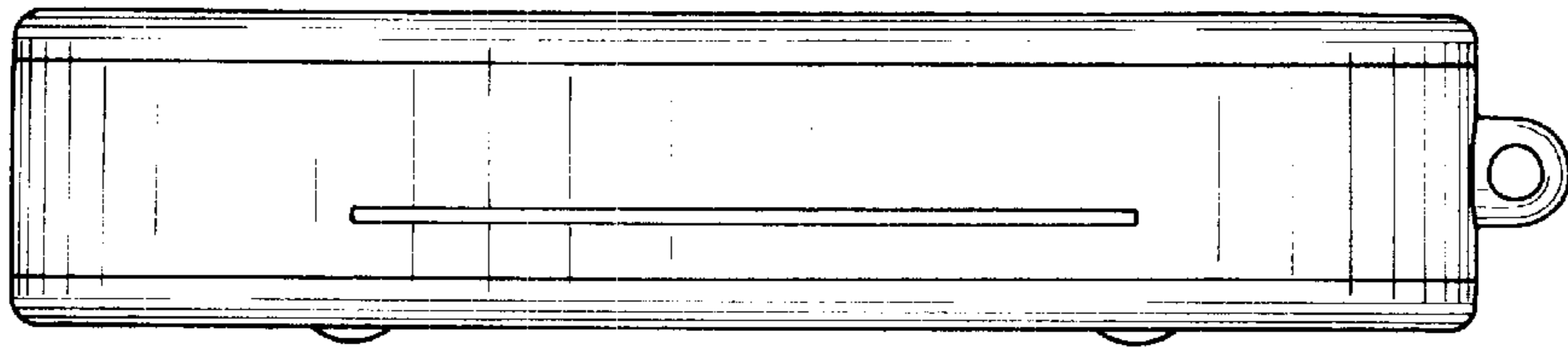

FIG. 3

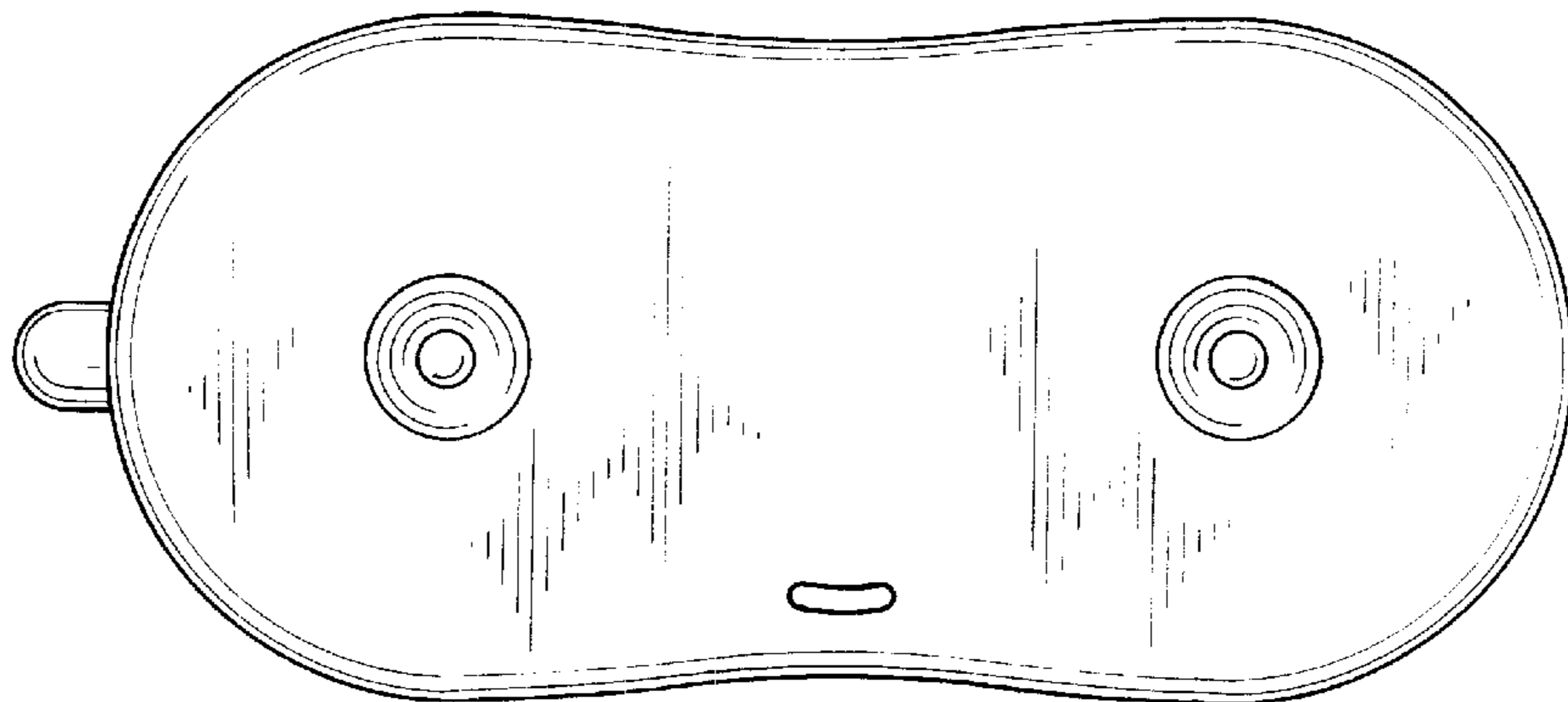

FIG. 4

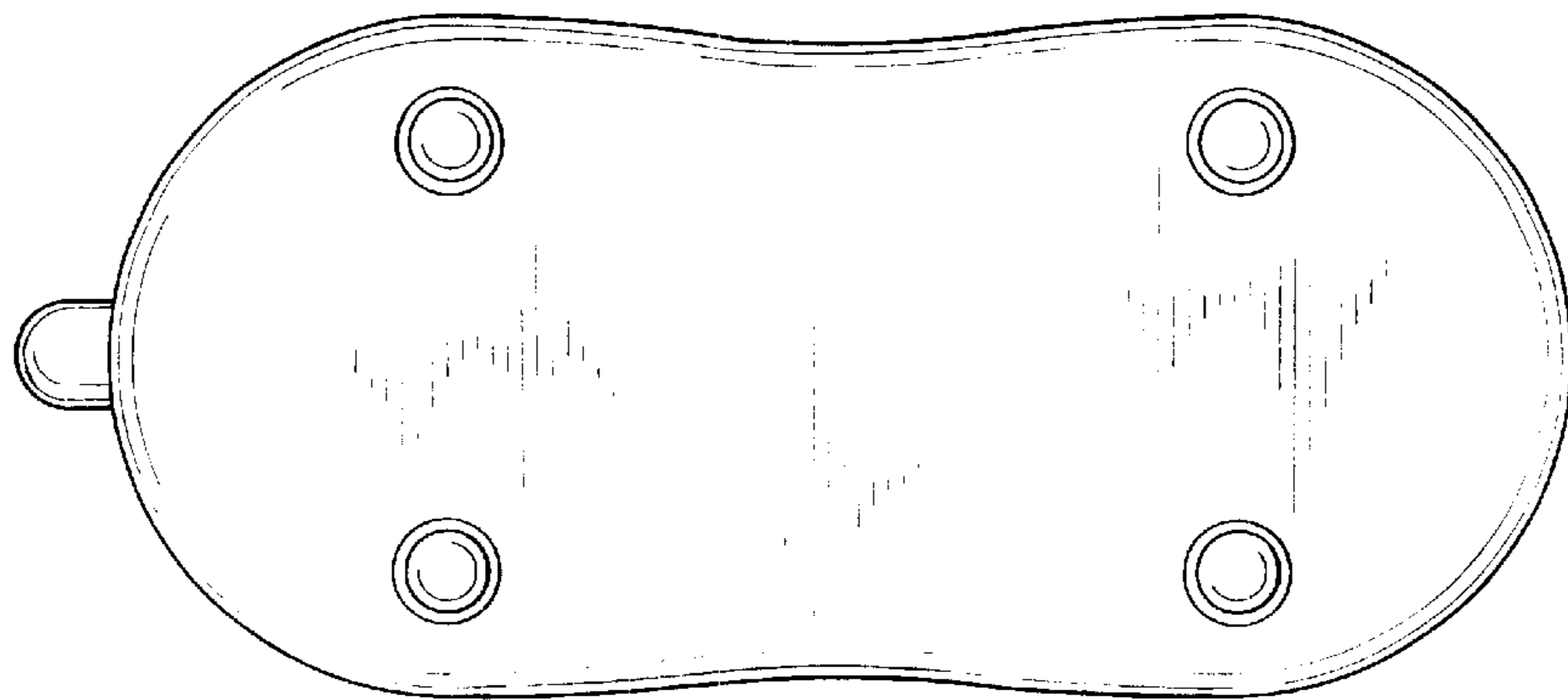

FIG. 5

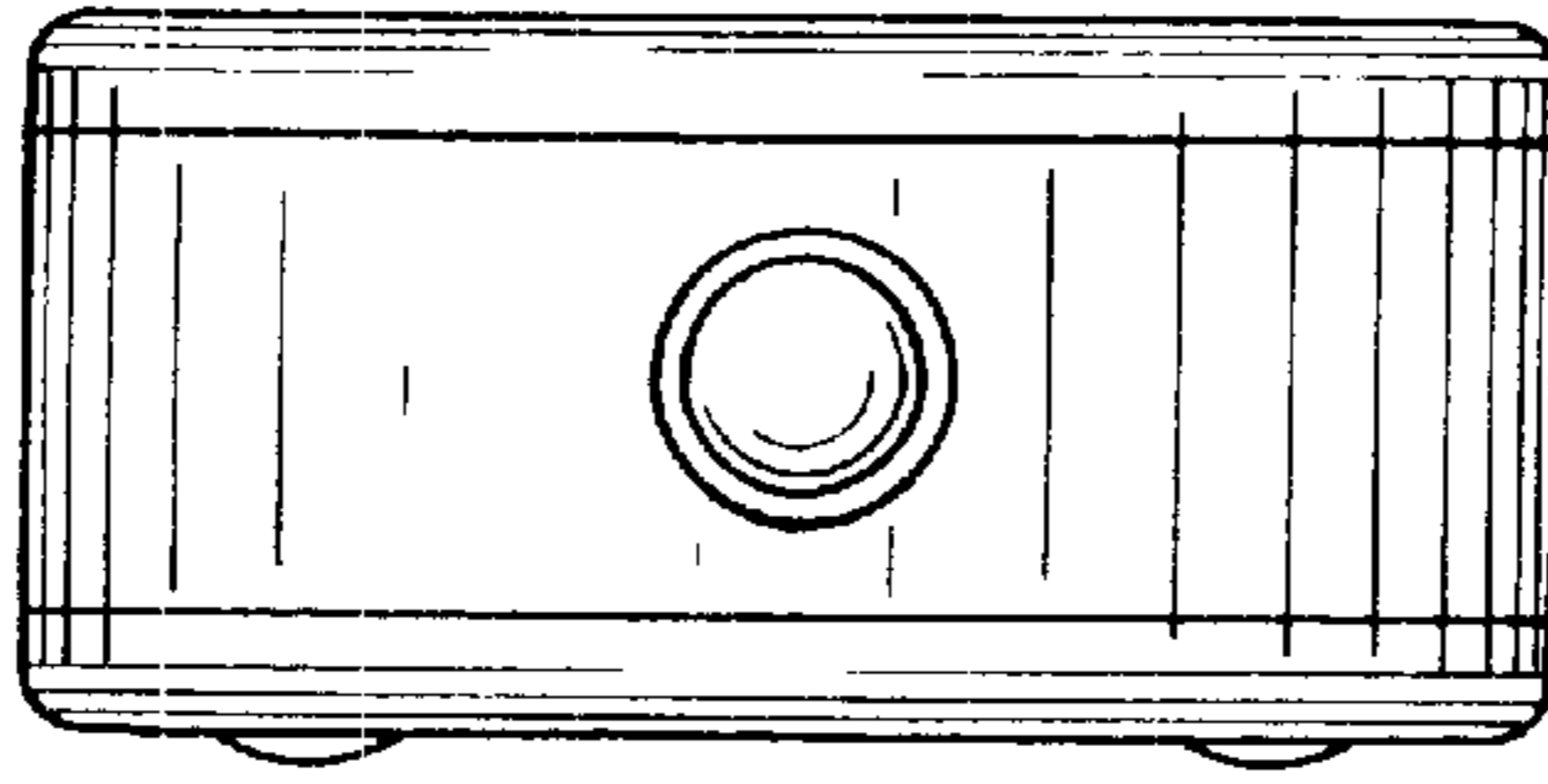

FIG. 6

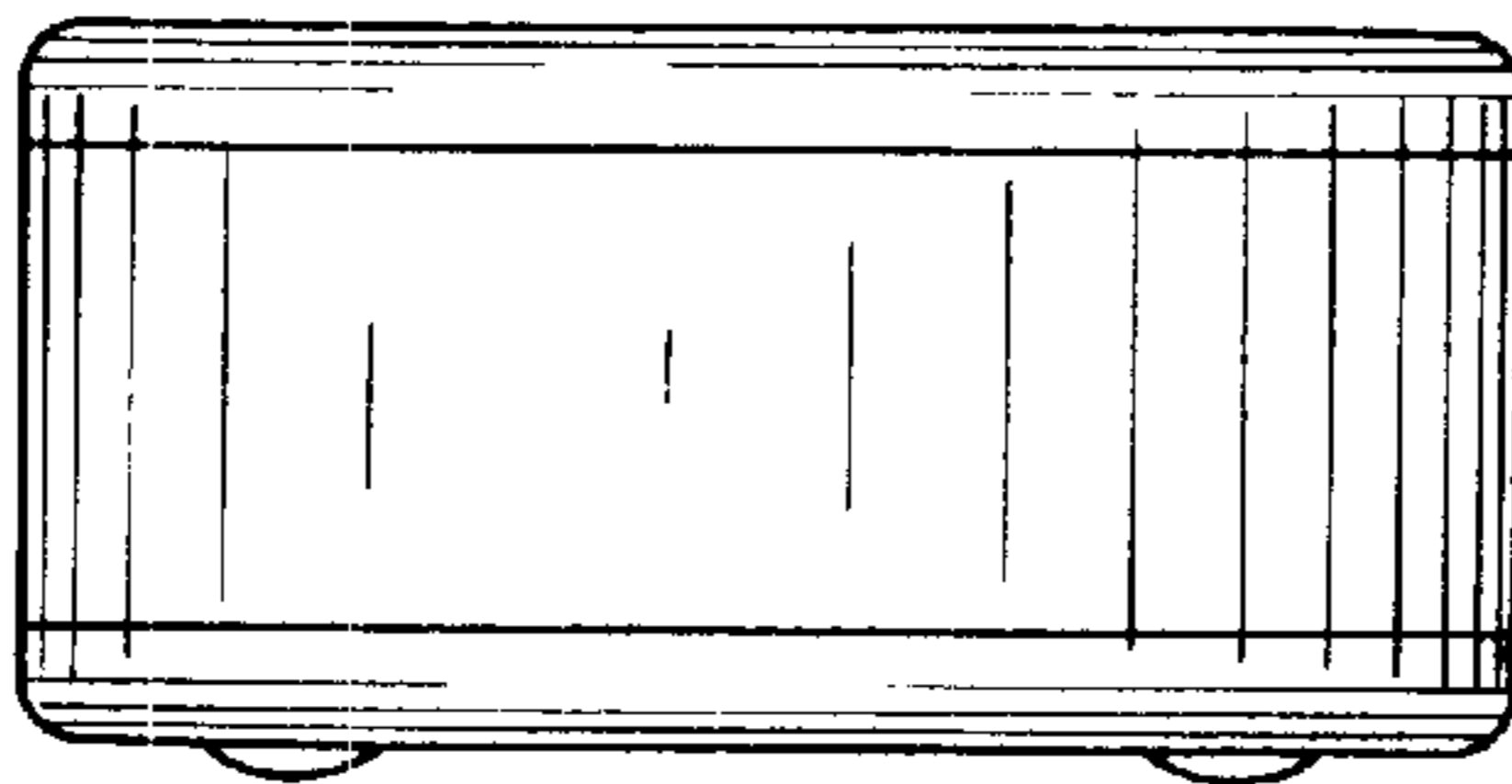

FIG. 7

