



US00D452493B1

(12) **United States Design Patent**
Bodley et al.

(10) **Patent No.:** **US D452,493 S**

(45) **Date of Patent:** **** Dec. 25, 2001**

(54) **MICROPHONE ARRAY**

781070 6/1997 (EP)

(75) Inventors: **Martin Reed Bodley**, Sudbury, MA (US); **Steve R. Lyman**, Hudson; **Ian Paul Smith**, Merrimack, both of NH (US)

(73) Assignee: **GN Netcom, Inc.**, Nashua, NH (US)

(**) Term: **14 Years**

(21) Appl. No.: **29/116,496**

(22) Filed: **Jan. 5, 2000**

(51) **LOC (7) Cl.** **14-01**

(52) **U.S. Cl.** **D14/227**

(58) **Field of Search** D14/225-229;
181/158-242; 381/26, 91, 111, 122, 369,
338, 189, 353

(56) **References Cited**

U.S. PATENT DOCUMENTS

D. 200,051	*	1/1965	Wassermann	D14/228
4,311,874		1/1982	Wallace, Jr.	
4,421,957	*	12/1983	Wallace, Jr.	381/338 X
4,559,642		12/1985	Miyaji et al.	
4,653,606	*	3/1987	Flanagan	181/158 X
5,058,170		10/1991	Kanamori et al.	
5,581,620		12/1996	Brandstein et al.	
5,657,393		8/1997	Crow	
5,848,172		12/1998	Allen et al.	
5,862,240		1/1999	Ohkubo et al.	

FOREIGN PATENT DOCUMENTS

44 45 549		3/1996	(DE)	
-----------	--	--------	------	-------	--

OTHER PUBLICATIONS

A Microphone Array for multimedia Workstations: Journal Audio Engineering Society, vol. 44, No. 5, May 1996, pp. 365-372.

“Design of Logarithmically Spaced Constant-Directivity Transducer Arrays” Journal Audio Engineering Society, vol. 44, No. 6, Jun. 1996, pp. 497-507.

* cited by examiner

Primary Examiner—Nanda Bondade

(74) *Attorney, Agent, or Firm*—Altera Law Group, LL

(57) **CLAIM**

The ornamental design for microphone array, as shown and described.

DESCRIPTION

FIG. 1 is a perspective view of the microphone array.

FIG. 2 is a top view thereof.

FIG. 3 is a bottom view thereof.

FIG. 4 is a front view thereof.

FIG. 5 is a rear perspective view thereof;

FIG. 6 is a side perspective view thereof.

FIG. 7 is a folded perspective view thereof;

FIG. 8 is an exploded bottom view thereof; and,

FIG. 9 is a top view of a foot thereof, shown separately for clarity of illustration.

1 Claim, 8 Drawing Sheets

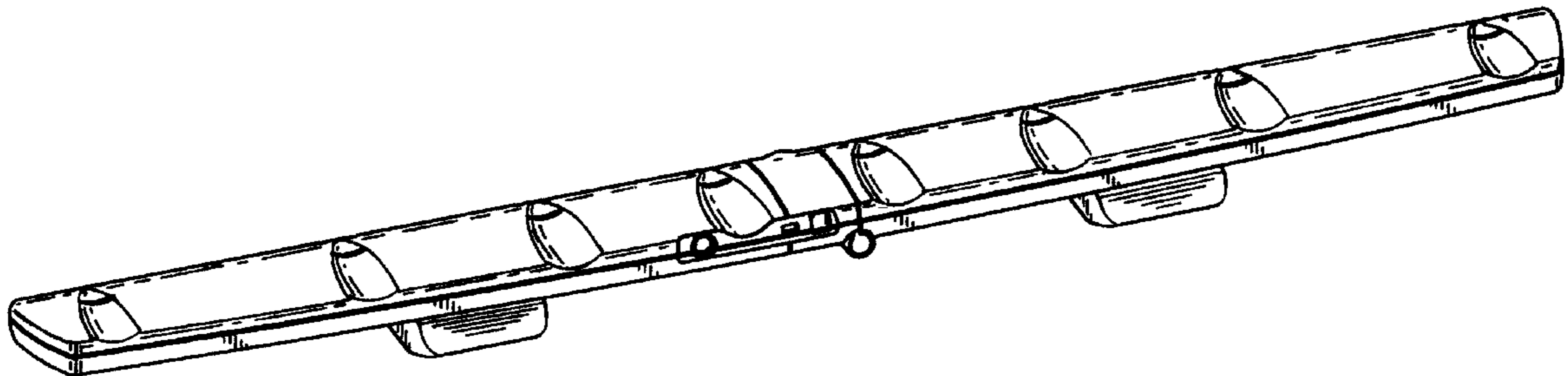

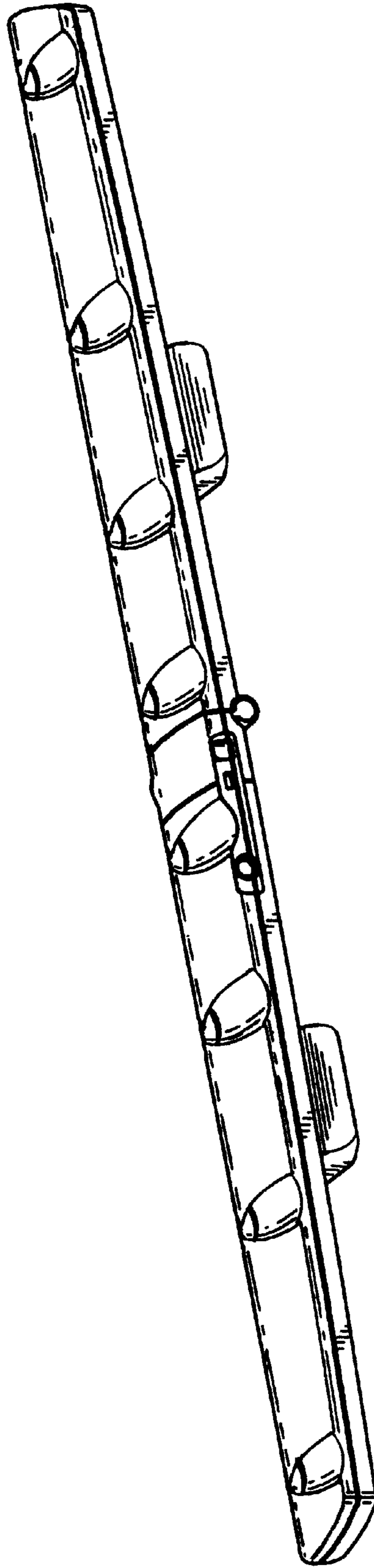

Fig. 1

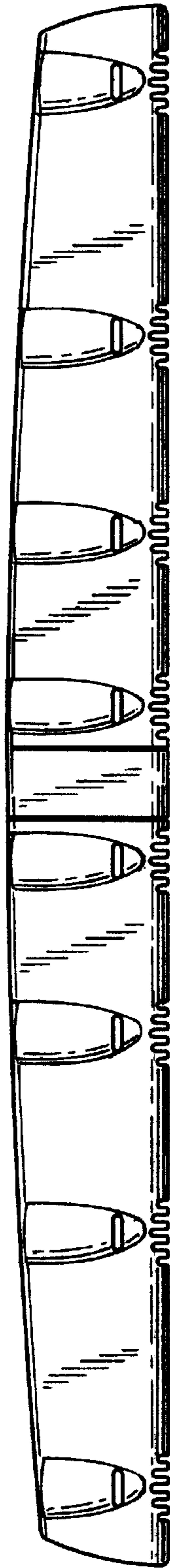

Fig. 2

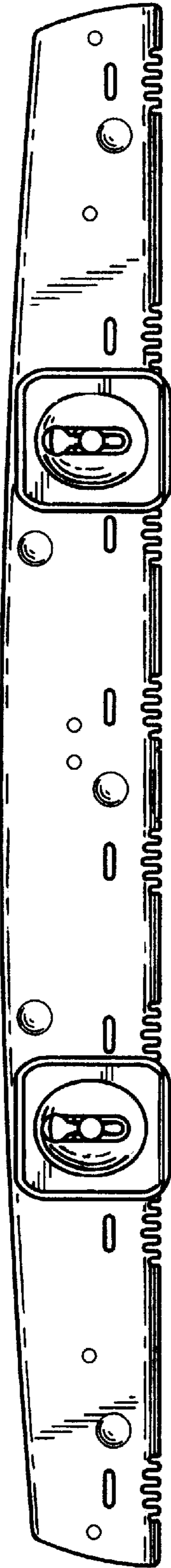

Fig. 3

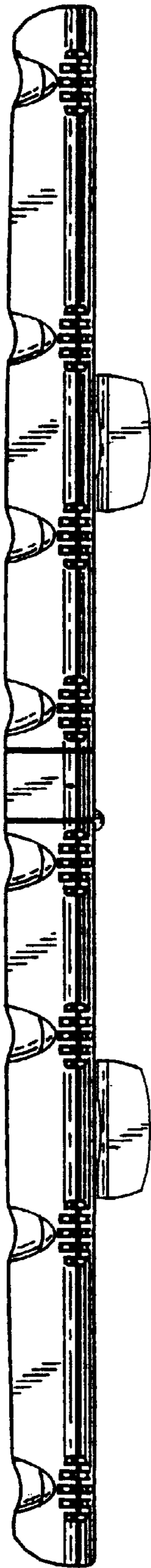

Fig. 4

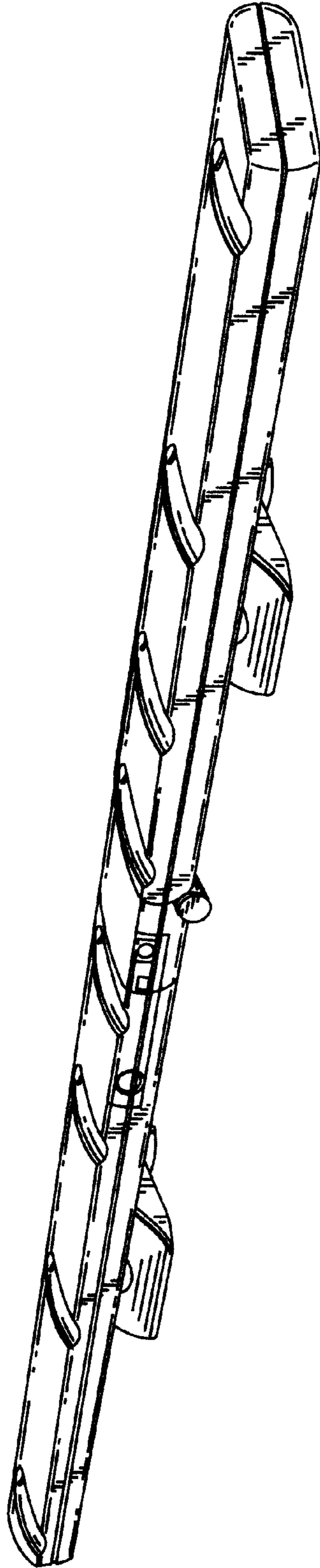

Fig .5

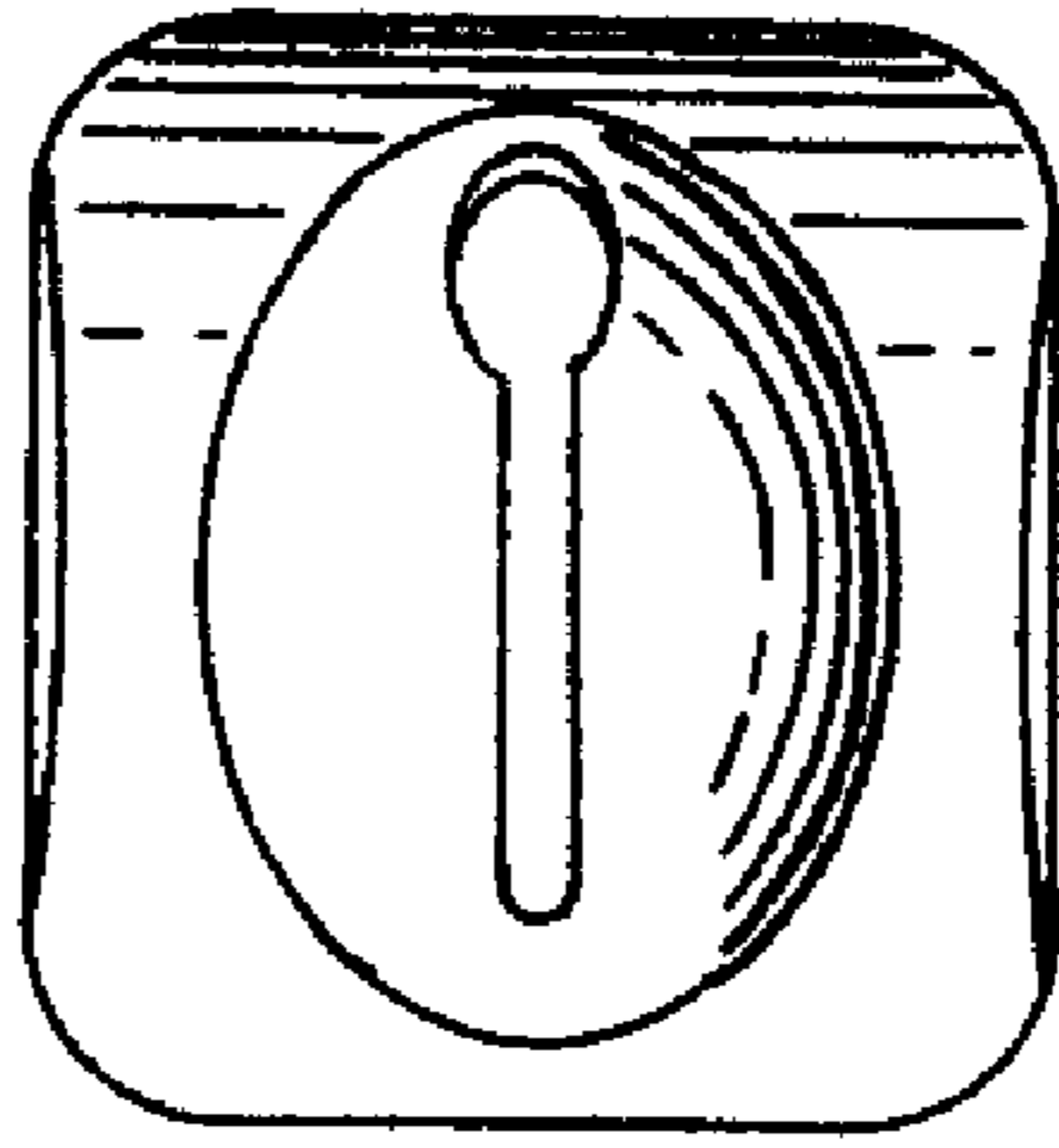

Fig. 9

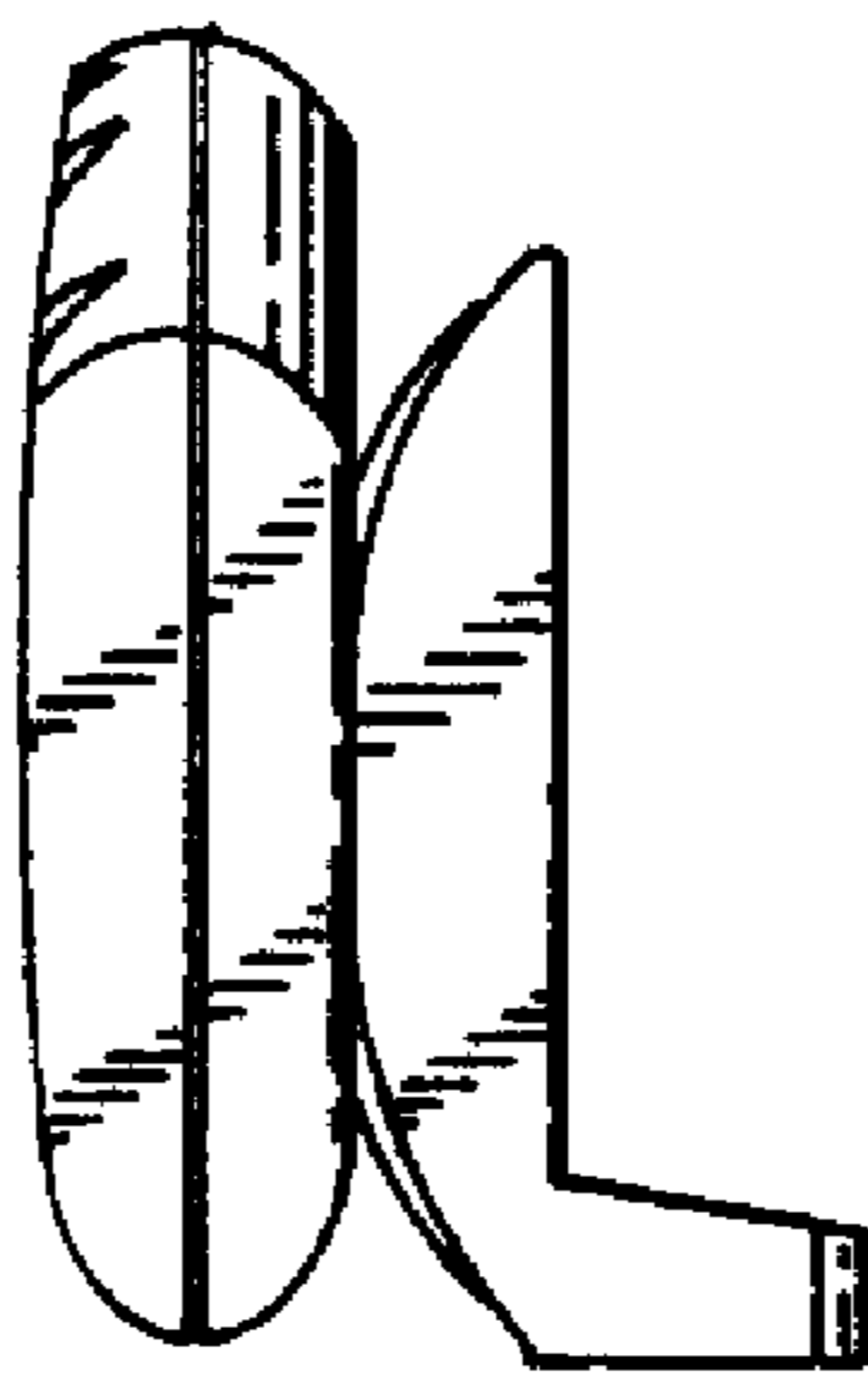

Fig. 6

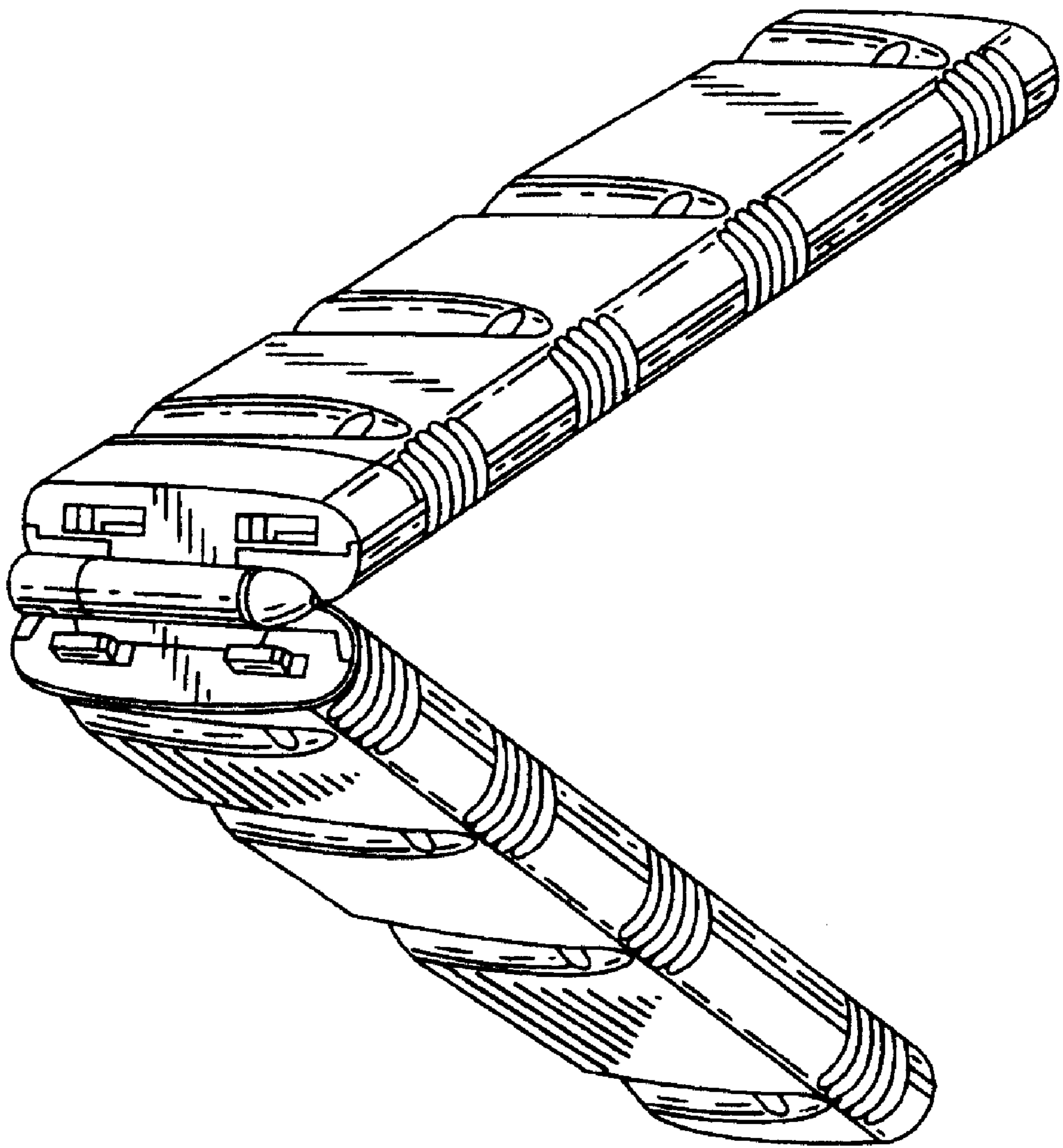

Fig. 7

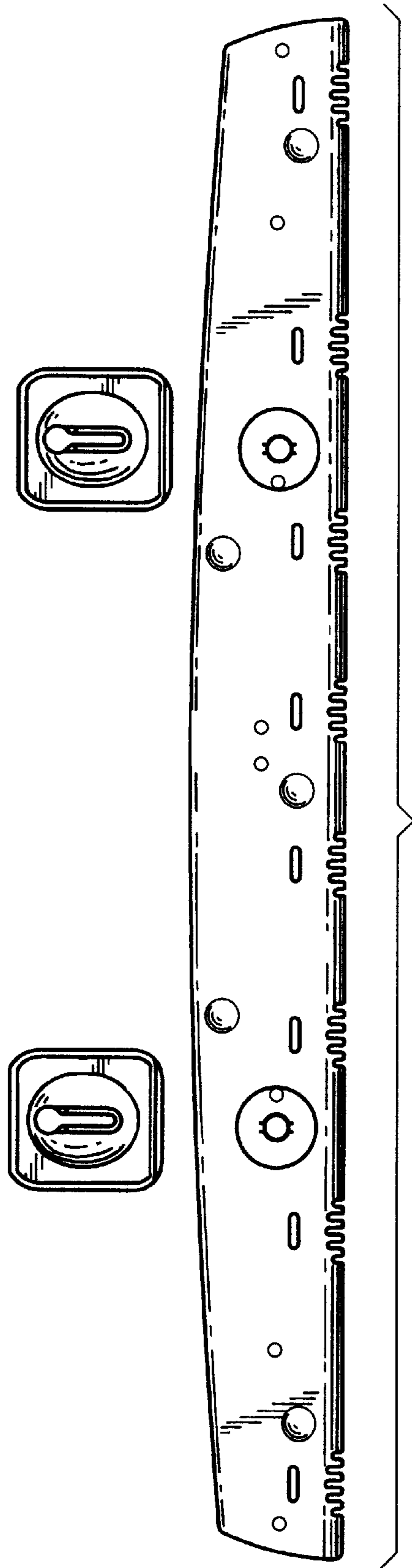

Fig. 8