



US00D452478B1

(12) **United States Design Patent**
Hiramoto et al.

(10) **Patent No.:** **US D452,478 S**

(45) **Date of Patent:** **** Dec. 25, 2001**

(54) **ELECTRIC CONNECTOR**

(75) Inventors: **Masayuki Hiramoto**, Hirakata;
Takashi Suyama, Amagasaki, both of
(JP)

(73) Assignee: **J.S.T. Mfg. Co., Ltd.**, Osaka (JP)

(*) Notice: This patent is subject to a terminal disclaimer.

(**) Term: **14 Years**

(21) Appl. No.: **29/132,815**

(22) Filed: **Nov. 17, 2000**

(30) **Foreign Application Priority Data**

May 19, 2000 (JP) 12-013307

(51) **LOC (7) Cl.** **13-03**

(52) **U.S. Cl.** **D13/147**

(58) **Field of Search** D13/146, 147;
439/397, 399, 400, 404, 460, 577, 660,
680, 733.1

(56) **References Cited**

U.S. PATENT DOCUMENTS

D. 316,846	*	5/1991	Moriai et al.	D13/147
4,255,009	*	3/1981	Clark	439/398
4,583,813	*	4/1986	Yamada	439/345
4,693,536	*	9/1987	Colleran et al.	439/404
4,820,179	*	4/1989	Saijo	439/224

4,984,998	*	1/1991	Duncan et al.	439/352
5,073,126	*	12/1991	Kikuchi et al.	439/452
5,380,220	*	1/1995	Okabe	439/456
5,415,562	*	5/1995	Matsumoto et al.	439/397
5,577,930	*	11/1996	Dahlem et al.	439/399
5,857,265	*	1/1999	Etiembre et al.	29/884

* cited by examiner

Primary Examiner—Joel Sincavage

(74) *Attorney, Agent, or Firm*—Antonelli, Terry, Stout & Kraus, LLP

(57) **CLAIM**

The ornamental design for an electric connector, as shown and described.

DESCRIPTION

FIG. 1 is a top plan view;
FIG. 2 is a front elevation;
FIG. 3 is a rear elevation;
FIG. 4 is a bottom plan view;
FIG. 5 is a right-side elevation;
FIG. 6 is a perspective view; and,
FIG. 7 is an auxiliary figure of the connector shown in use, in which the subject article having eight electrical wire ends, secured thereto is fitted in a mating connector.

The broken lines showing the mating connector and the electrical wire ends in FIG. 7 are included for the purpose of illustrating environmental structure only and form no part of the claimed design.

1 Claim, 2 Drawing Sheets

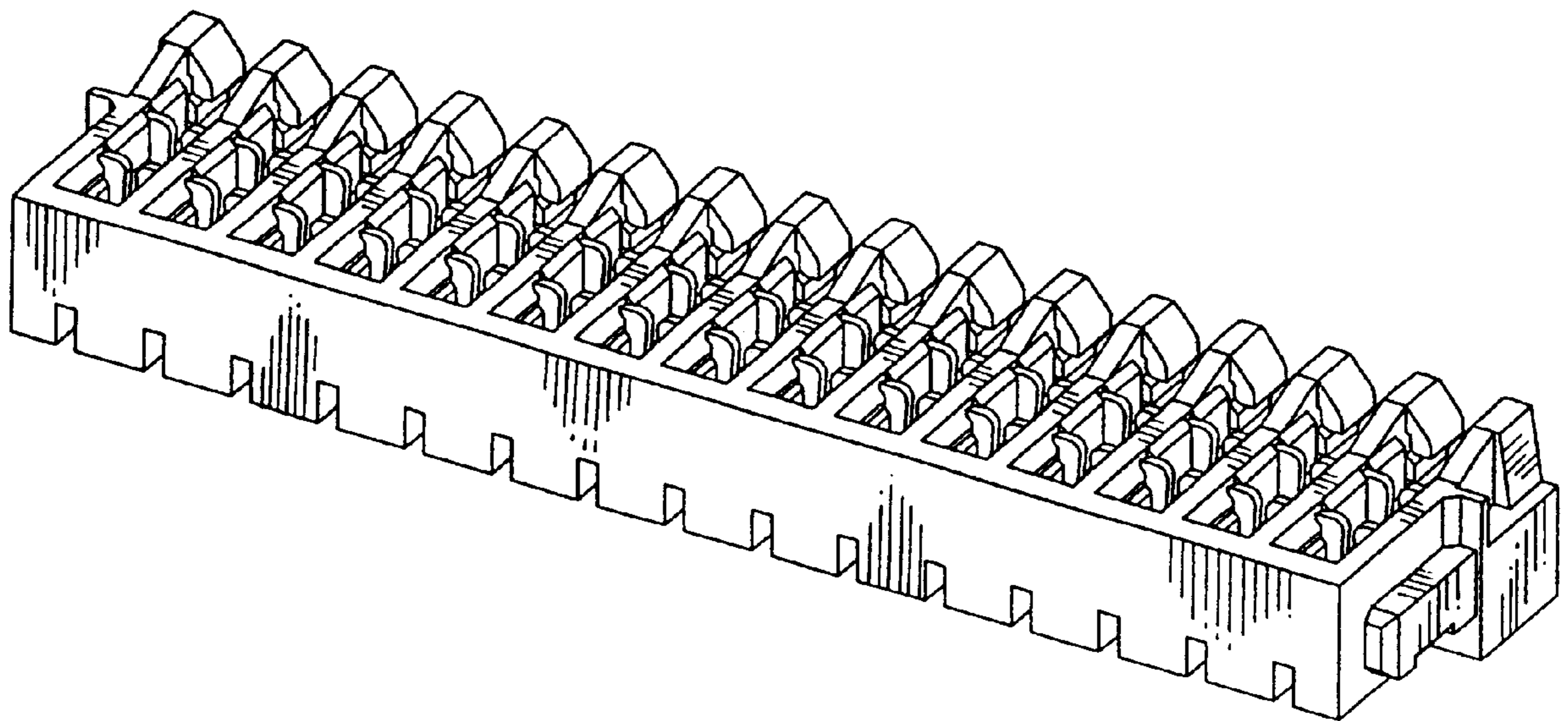

Fig. 1

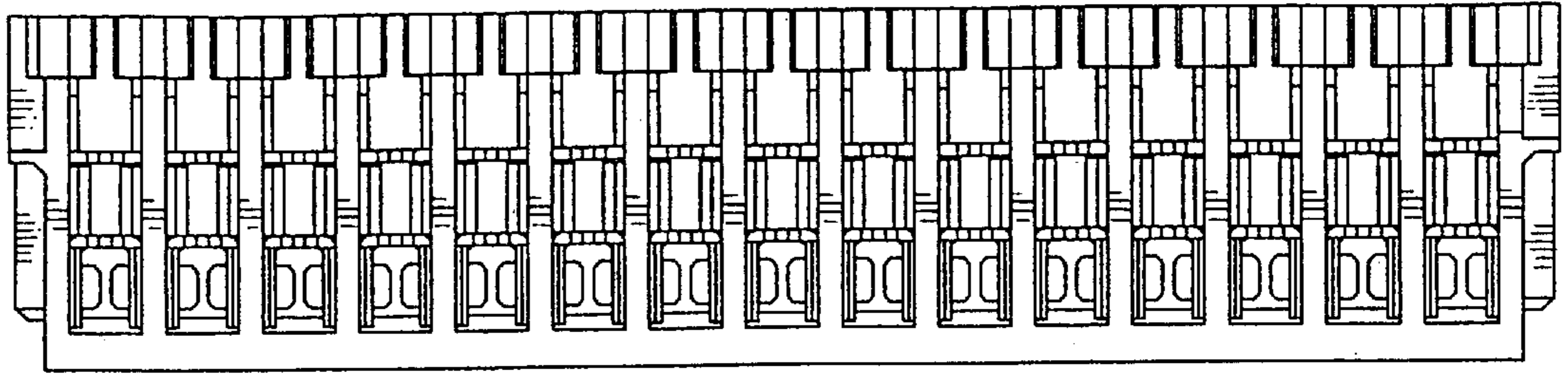

Fig. 2

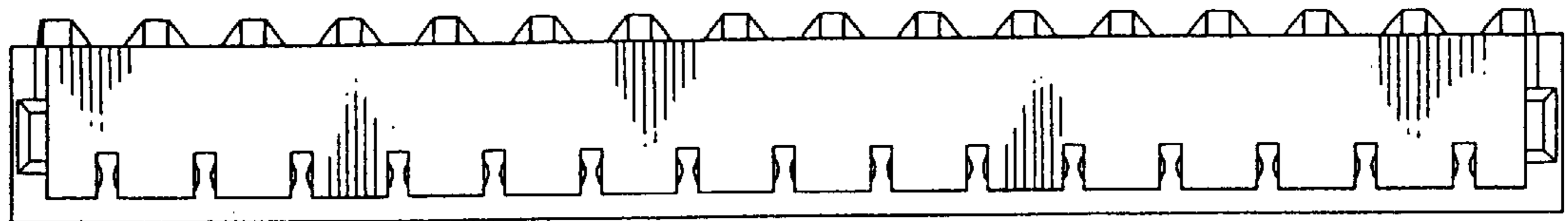

Fig. 3

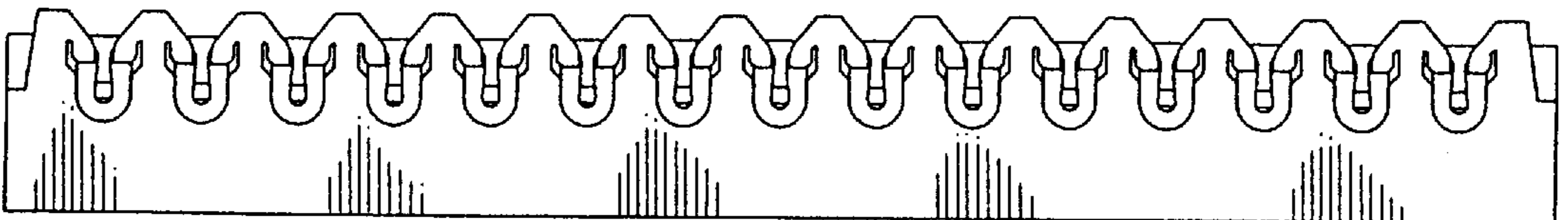

Fig. 4

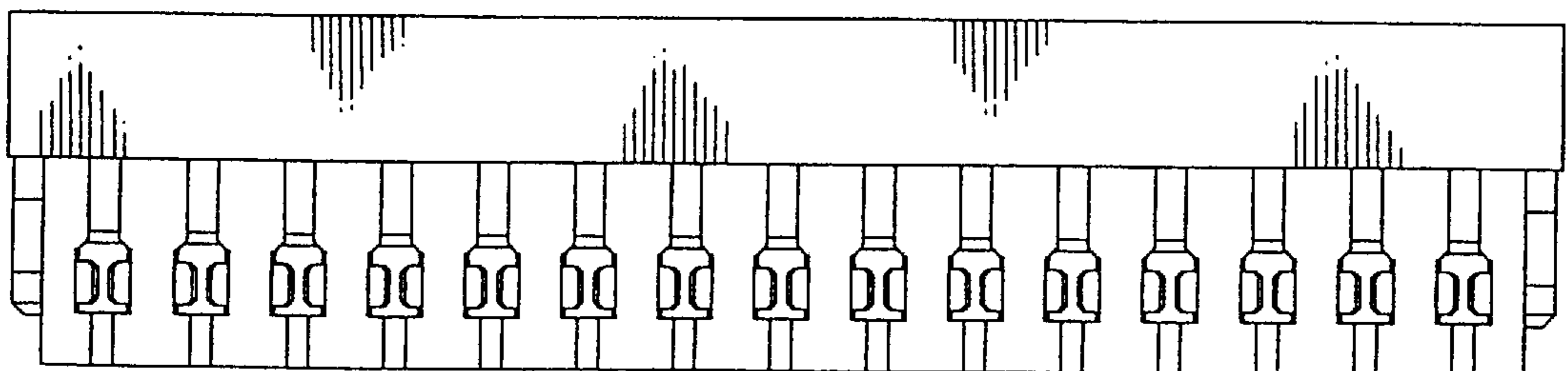
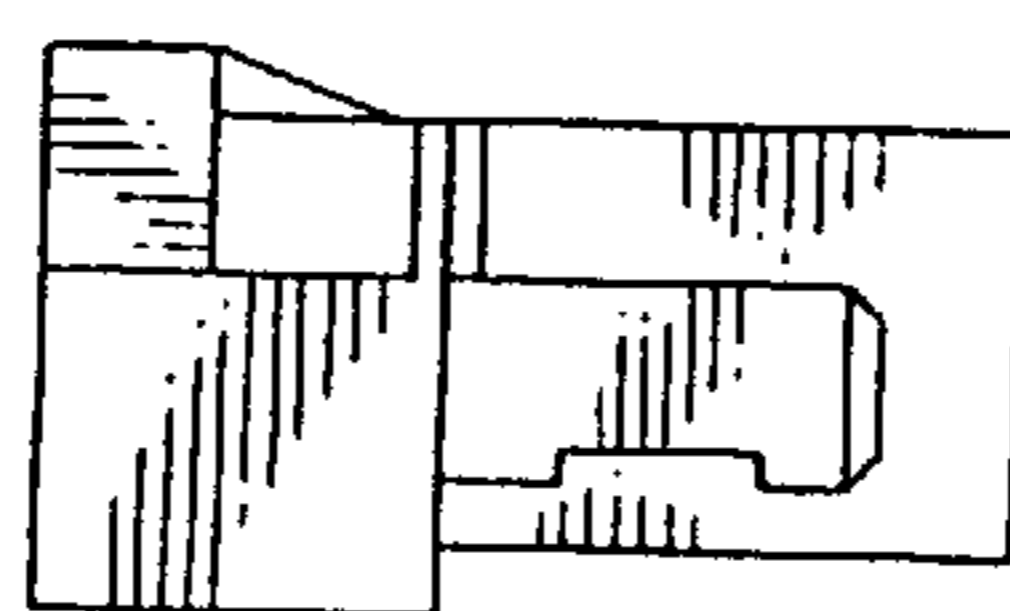

Fig. 5



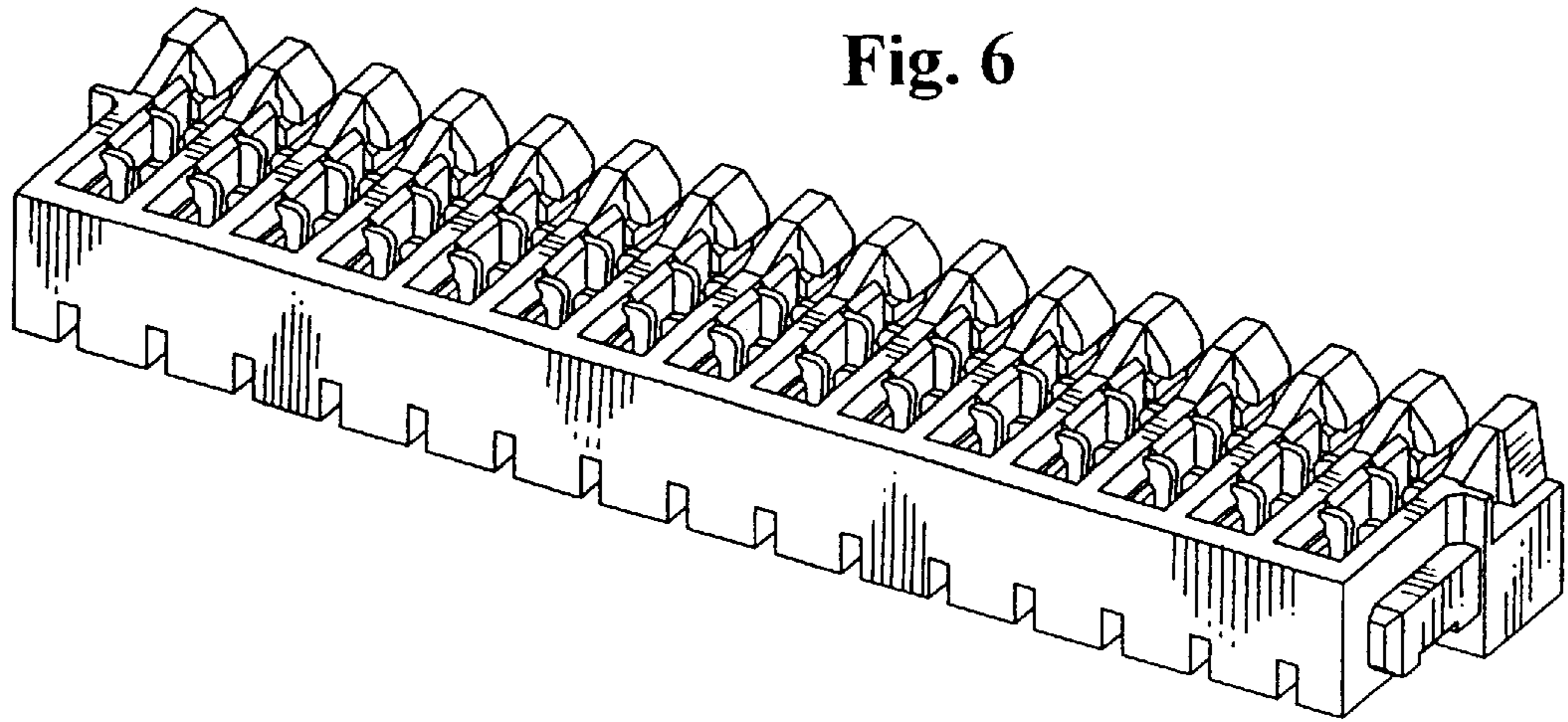

Fig. 6

Fig. 7

