



US00D452459B1

(12) **United States Design Patent**  
**Riley**

(10) **Patent No.:** **US D452,459 S**

(45) **Date of Patent:** **\*\* Dec. 25, 2001**

(54) **BREAKAWAY BUCKLE**

(76) Inventor: **Phil Riley**, 6024 SW. Jean Rd. #175-F,  
Lake Oswego, OR (US) 97035

(\*\*) Term: **14 Years**

(21) Appl. No.: **29/111,108**

(22) Filed: **Sep. 20, 1999**

(51) **LOC (7) Cl.** ..... **02-07**

(52) **U.S. Cl.** ..... **D11/216**

(58) **Field of Search** ..... D11/200-220,  
D11/224, 231; D2/639; 24/163 R, 615,  
616, 625, 633, 614, 650, 196

(56) **References Cited**

**U.S. PATENT DOCUMENTS**

D. 56,246	*	9/1920	Alterson	.....	D11/216
D. 210,762	*	4/1968	Jantzen	.....	D11/216
D. 234,548	*	3/1975	Stahel	.....	D11/216 X
D. 400,474	*	11/1998	Chou	.....	D11/216
3,321,817	*	5/1967	Smith et al.	.....	24/163 R
3,378,895	*	4/1968	Eberhart	.....	24/163 R
5,205,021	*	4/1993	Durand	.....	24/163 R

\* cited by examiner

*Primary Examiner*—Louis S. Zarfes

*Assistant Examiner*—Catherine R. Oliver

(74) *Attorney, Agent, or Firm*—Morriss, Bateman O'Bryant  
& Compagni

(57) **CLAIM**

The ornamental design for a breakaway buckle, as shown and described.

**DESCRIPTION**

FIG. 1 is a perspective view of the breakaway buckle showing my new design;

FIG. 2 is a top plan view thereof;

FIG. 3 is a front elevational view thereof;

FIG. 4 is a rear elevational view thereof;

FIG. 5 is a right side elevational view, with the left side elevational view being a mirror image thereof;

FIG. 6 is bottom plan view thereof;

FIG. 7 is a perspective view of the male member;

FIG. 8 is a top plan view thereof;

FIG. 9 is a rear elevational view thereof;

FIG. 10 is a front elevational view thereof;

FIG. 11 is a right side elevational view, the left side elevational view being a mirror image thereof;

FIG. 12 is a bottom plan view thereof;

FIG. 13 is a perspective view of the female member;

FIG. 14 is a top plan view thereof;

FIG. 15 is a rear elevational view thereof;

FIG. 16 is a front elevational view thereof;

FIG. 17 is a right side elevational view, the left side elevational view being a mirror image thereof; and,

FIG. 18 is a bottom plan view thereof.

The broken line showing of environment is for illustrative purposes only and forms no part of the claimed design.

**1 Claim, 3 Drawing Sheets**

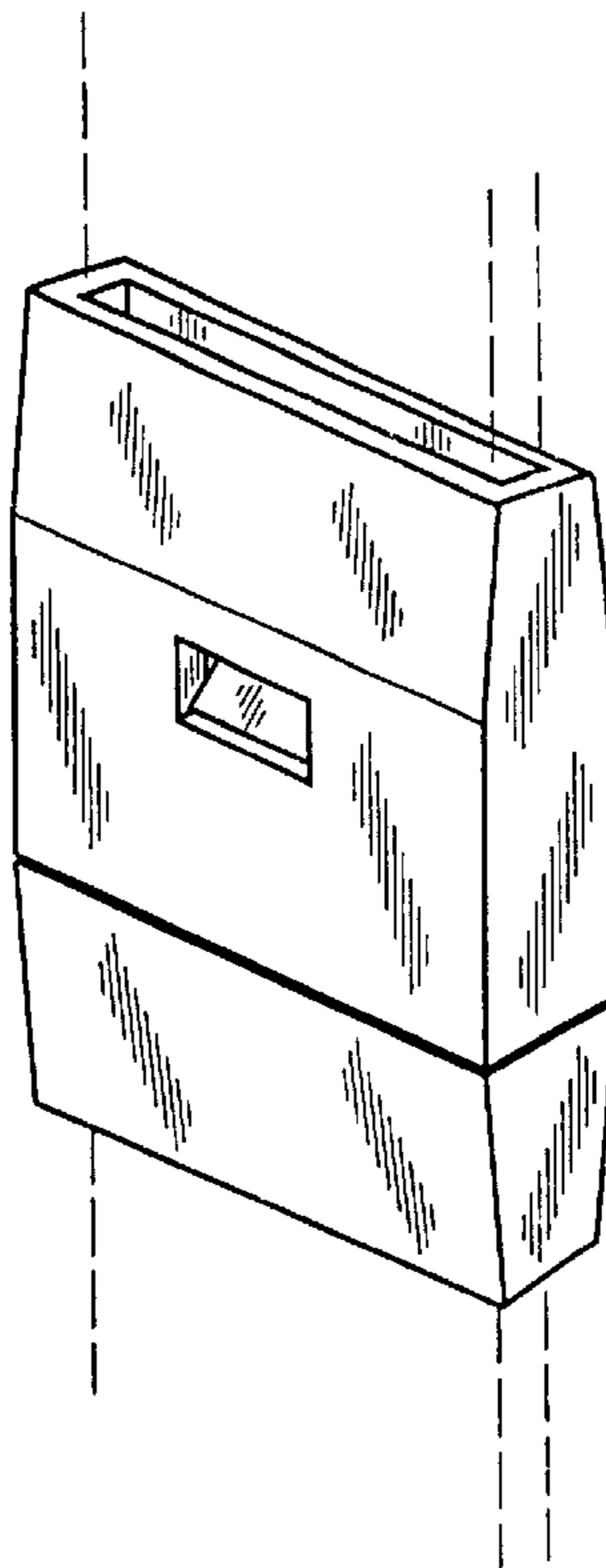

**FIG. 1**

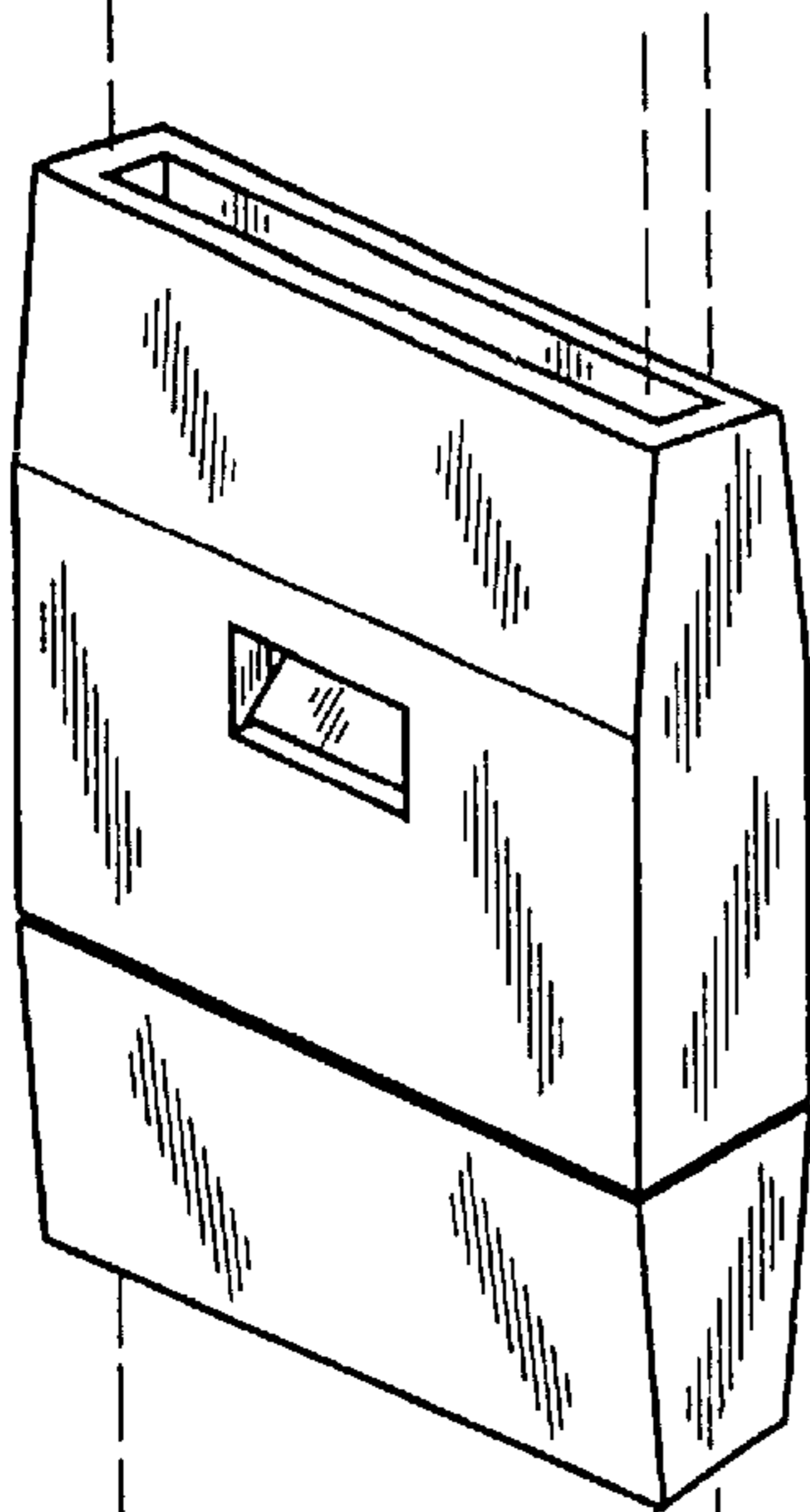

**FIG. 2**

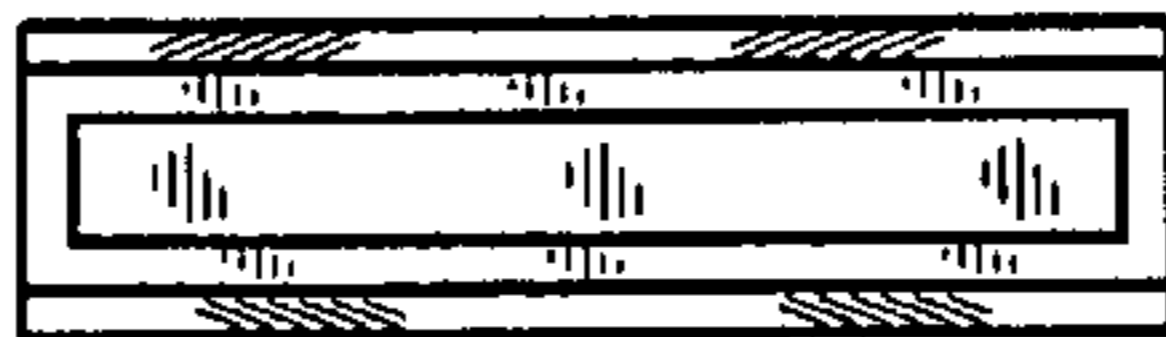

**FIG. 4**

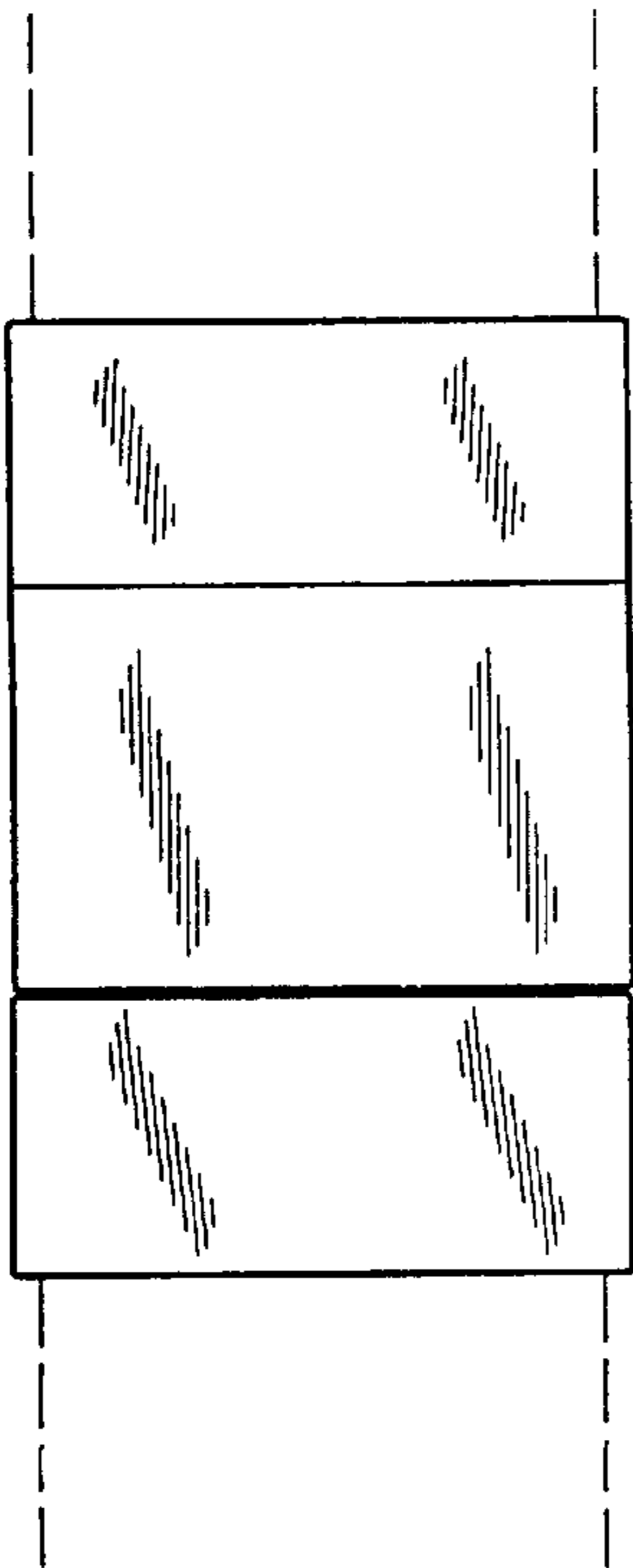

**FIG. 3**

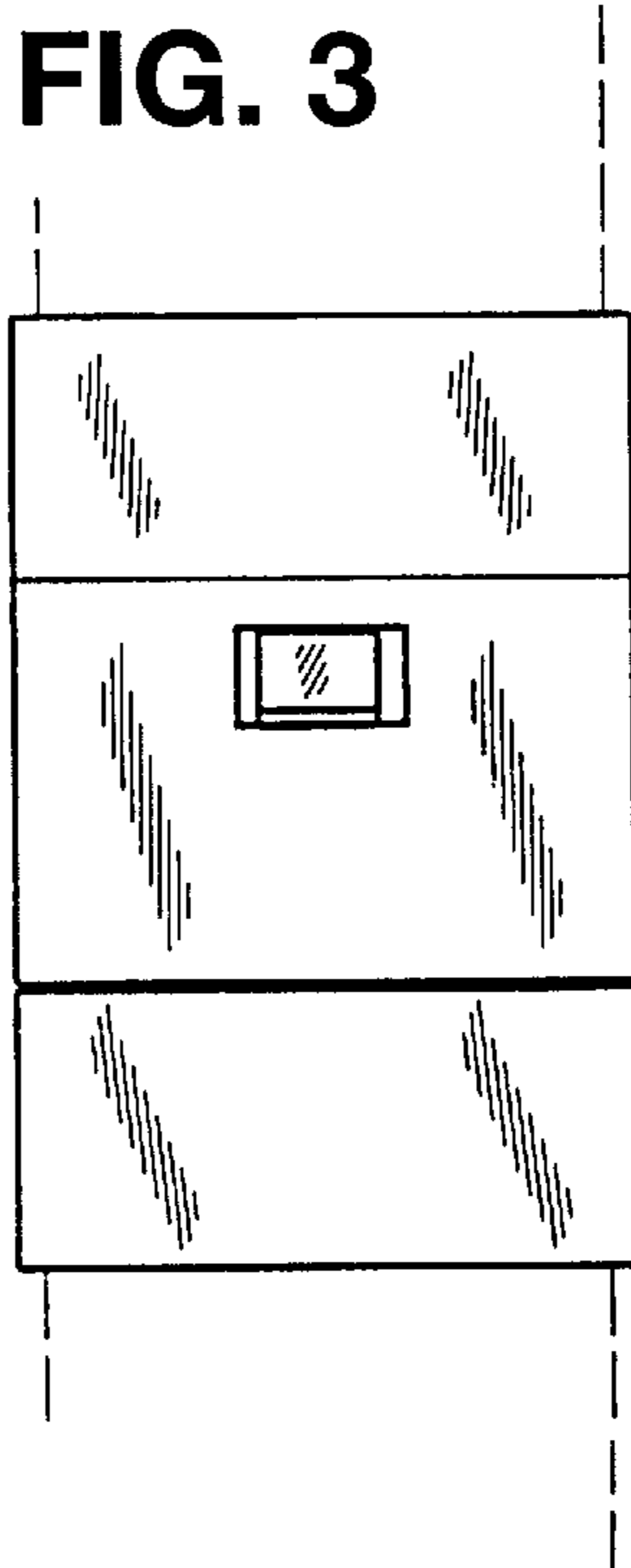

**FIG. 5**

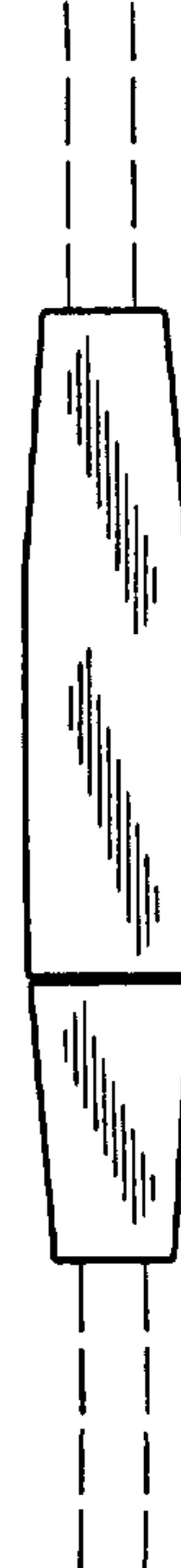

**FIG. 6**

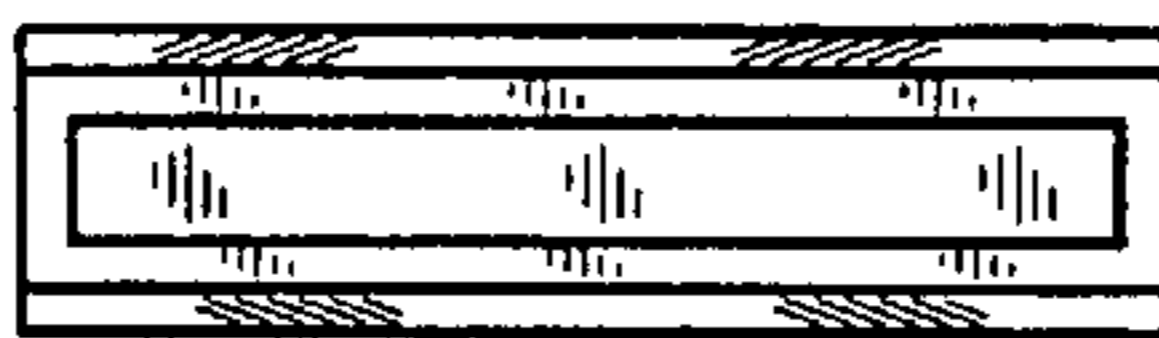

**FIG. 7**

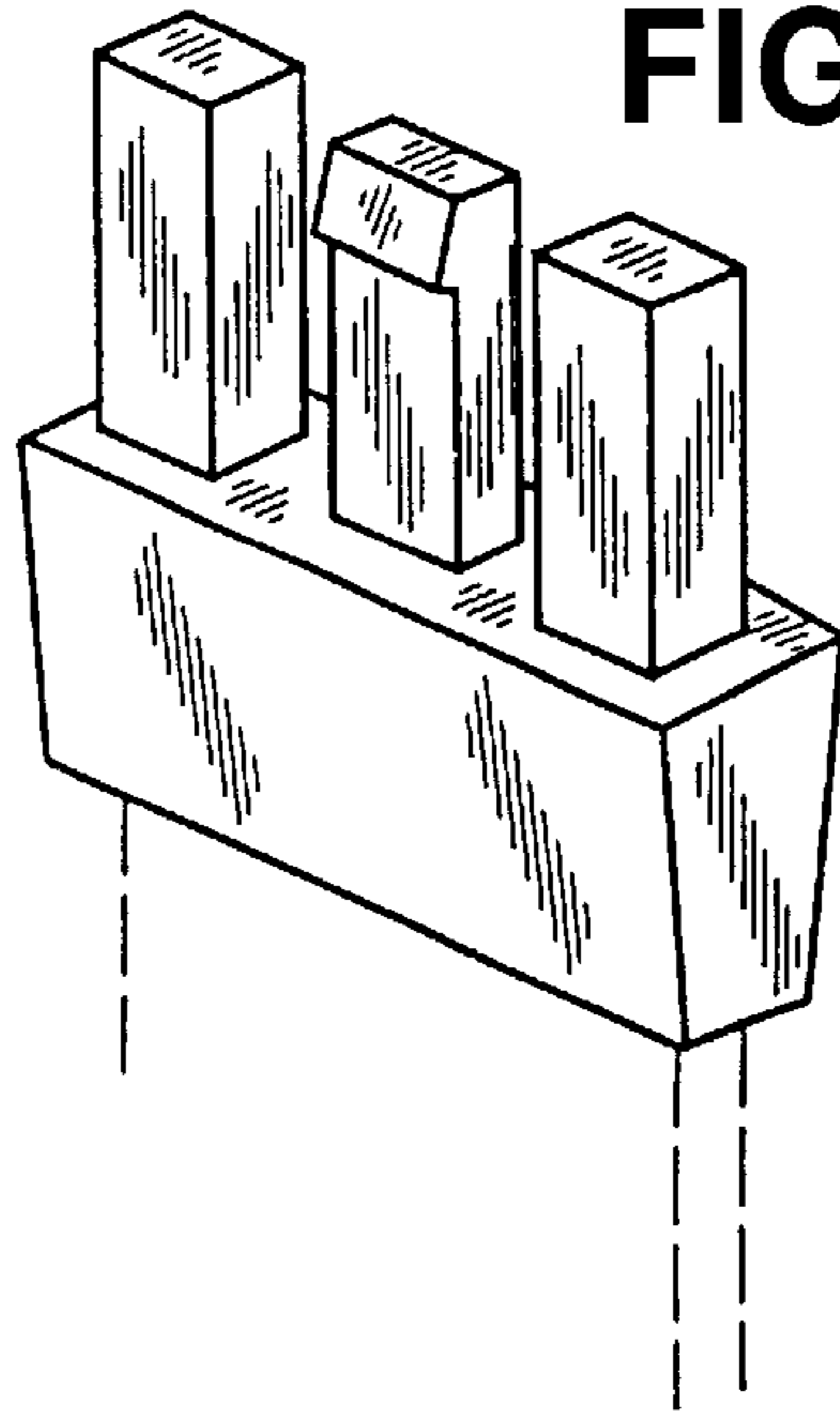

**FIG. 8**



**FIG. 9**

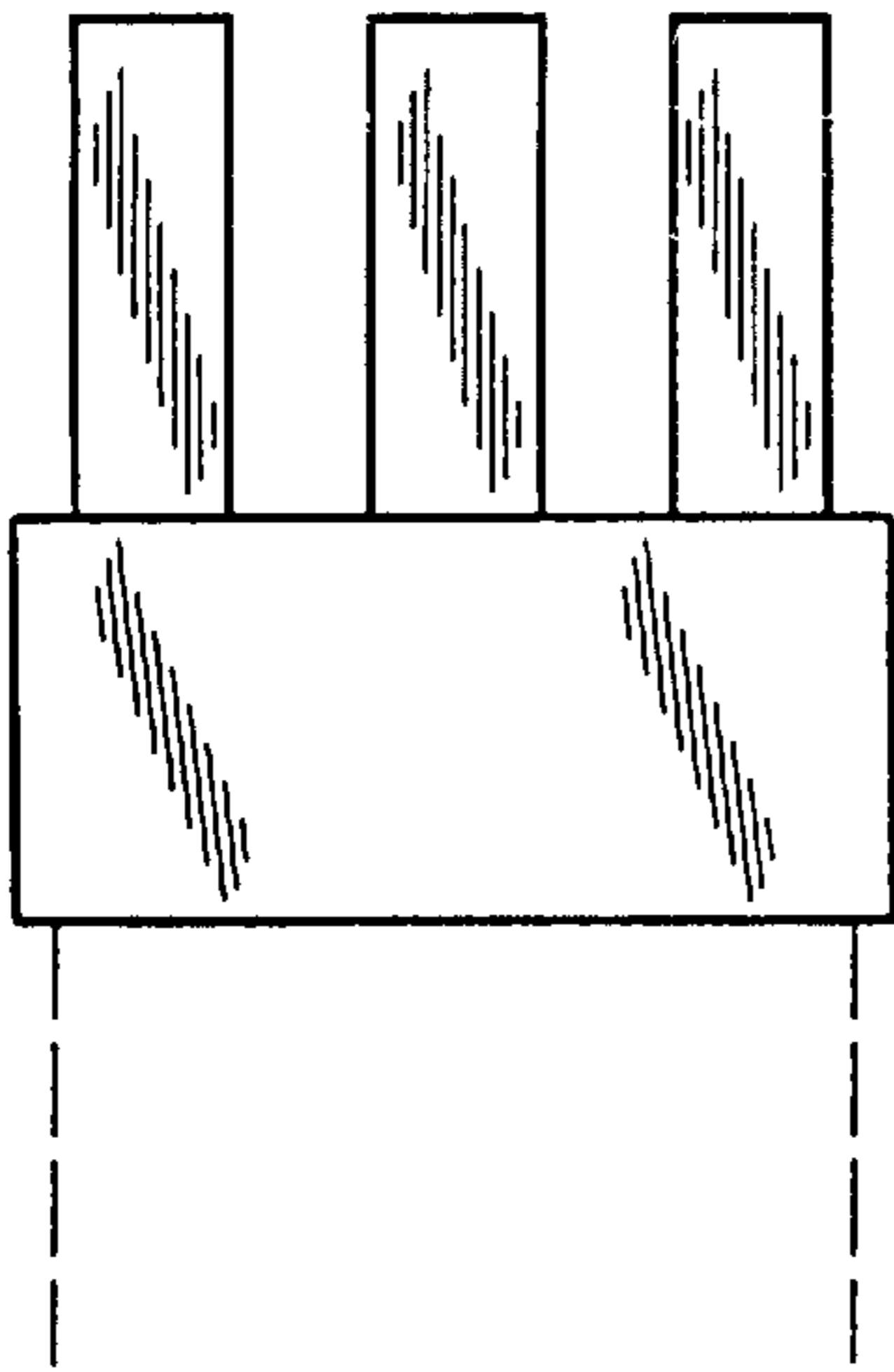

**FIG. 10**

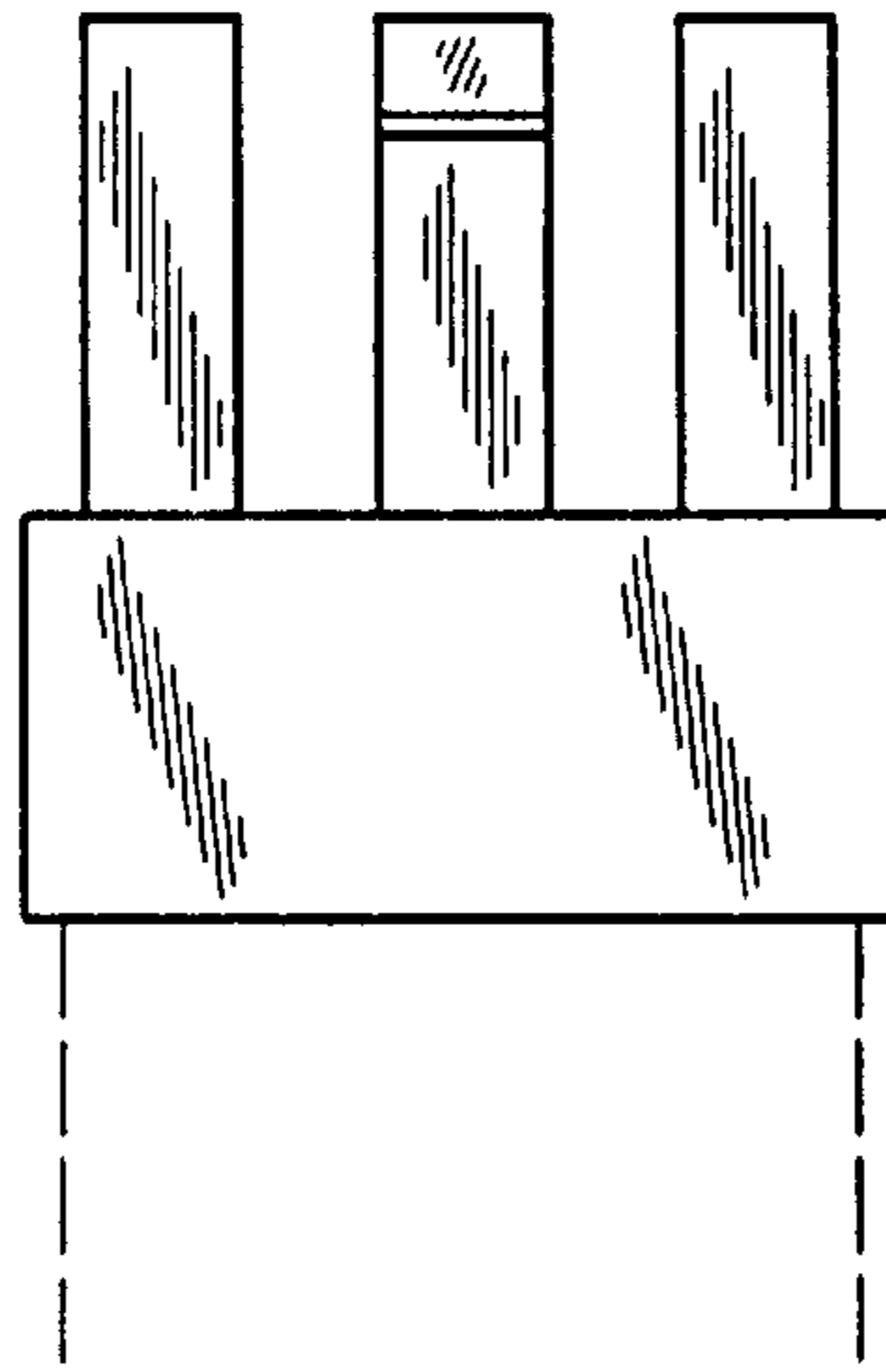

**FIG. 11**



**FIG. 12**

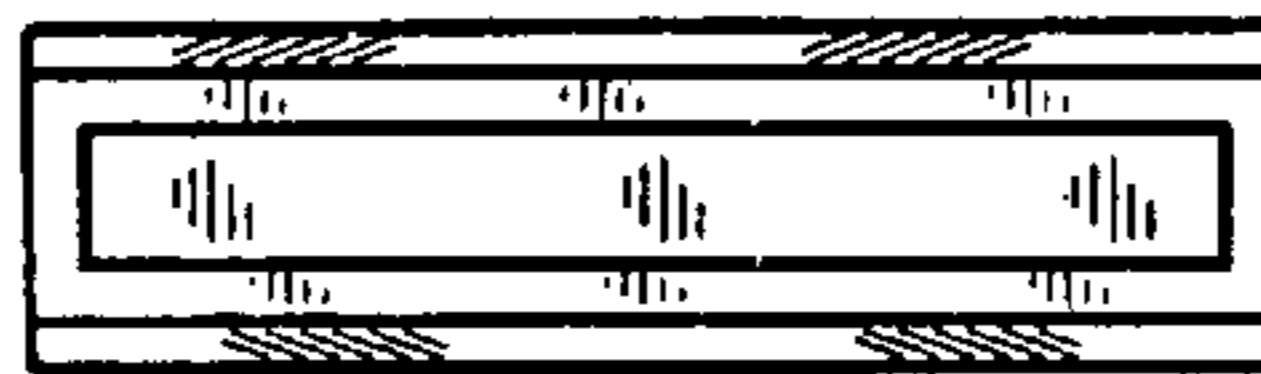

**FIG. 13**

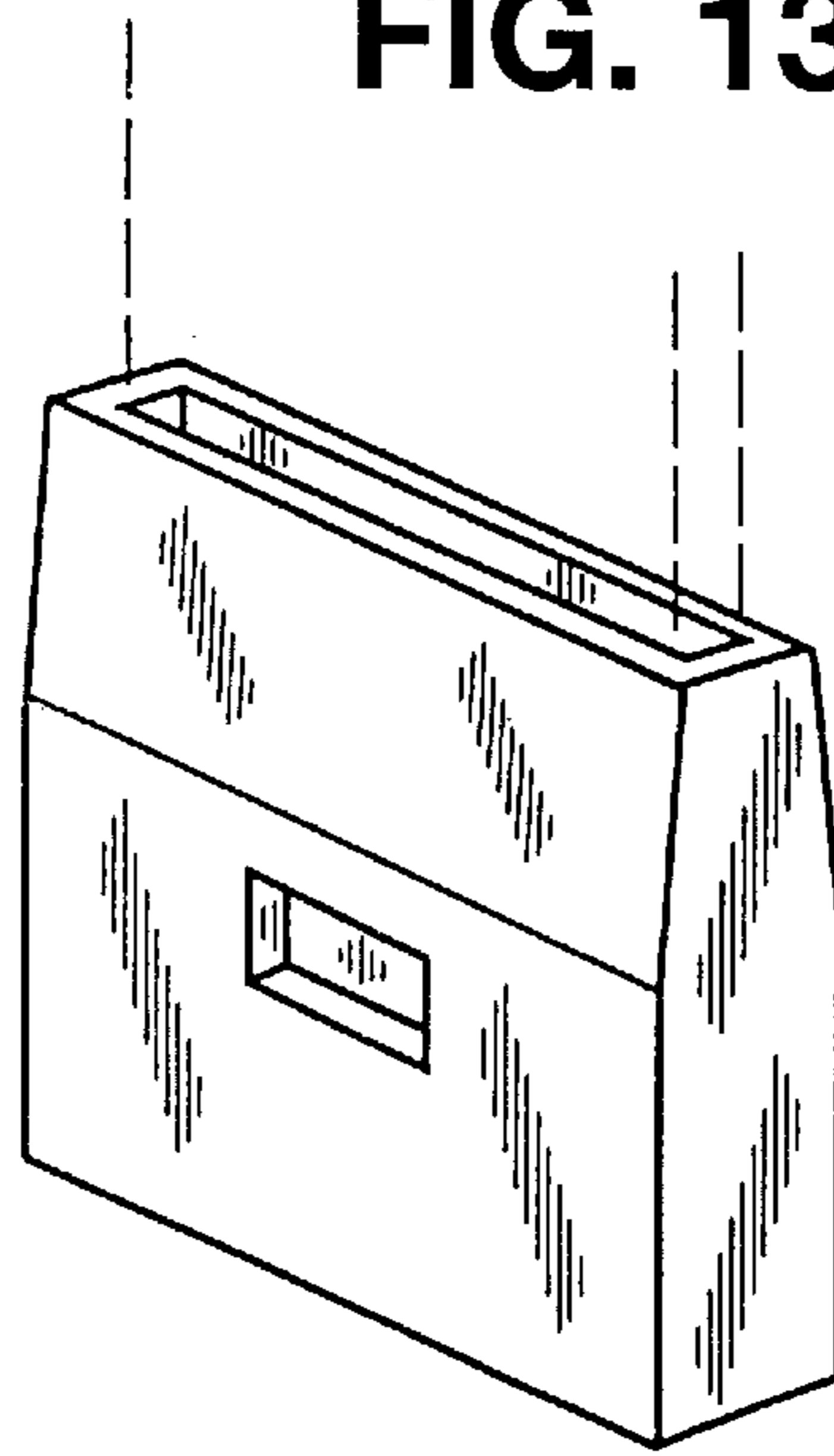

**FIG. 14**

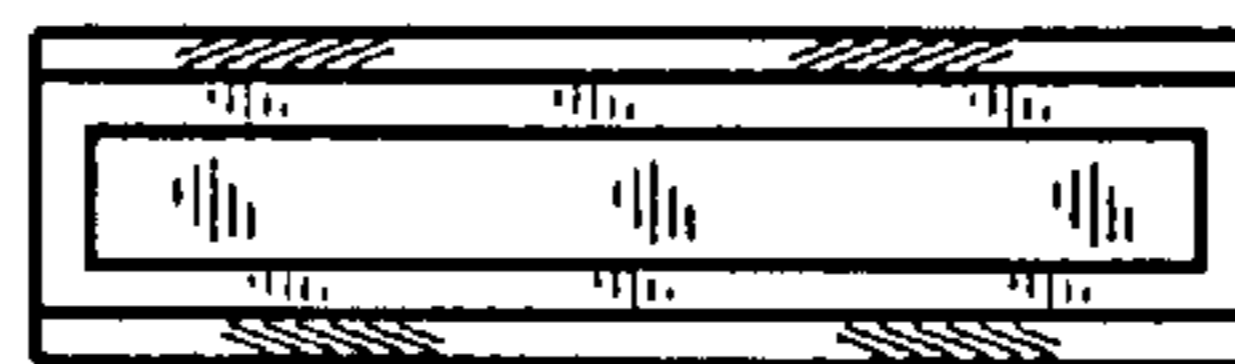

**FIG. 15**

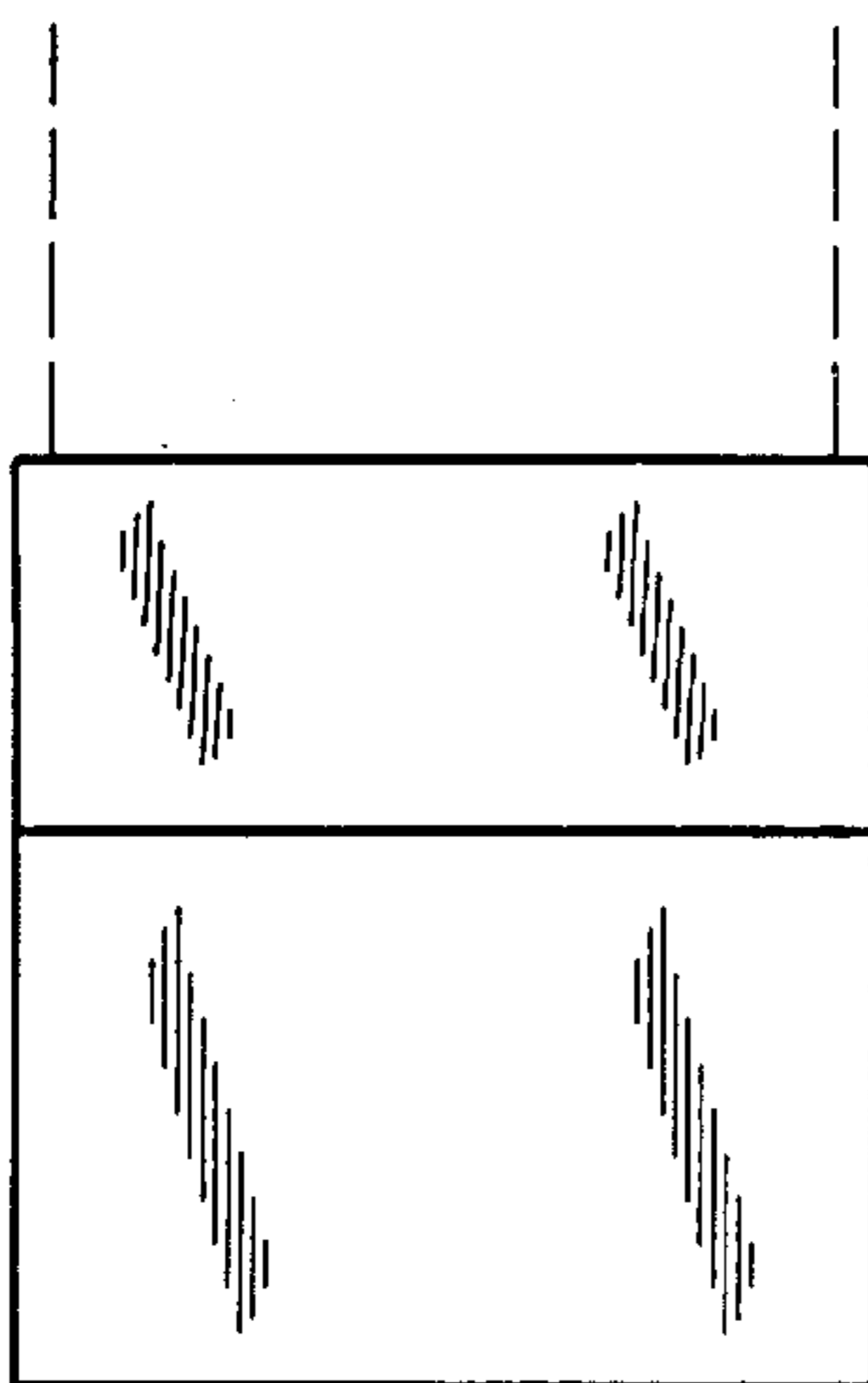

**FIG. 16**

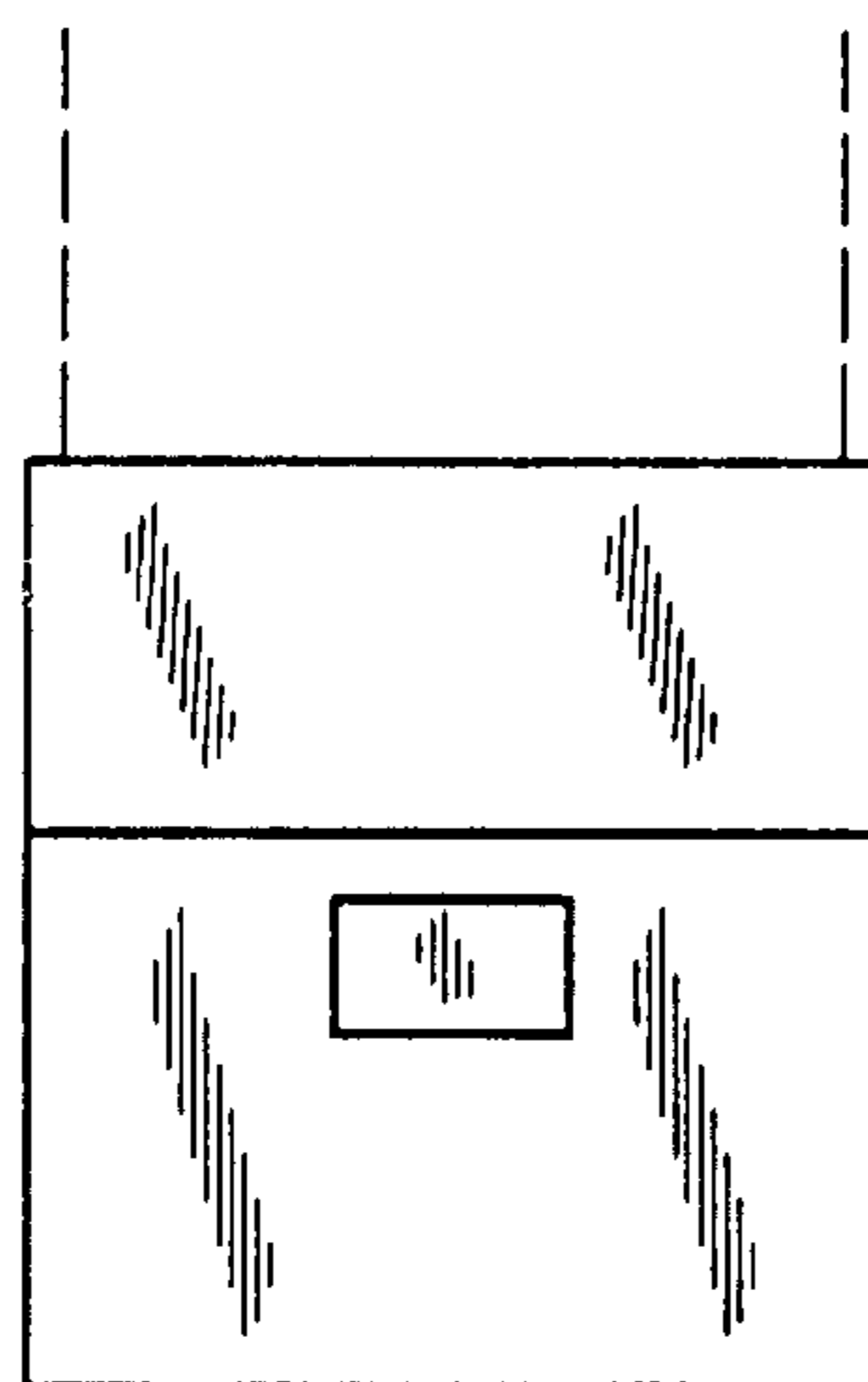

**FIG. 17**



**FIG. 18**

