



US00D452402B1

(12) **United States Design Patent**
Chen

(10) **Patent No.:** **US D452,402 S**

(45) **Date of Patent:** **** Dec. 25, 2001**

(54) **TOWEL BAR POST**

(76) Inventor: **Lien-Fu Chen**, 11, Lane 66, Fu-Dong St., Chang-Hua City (TW)

(**) Term: **14 Years**

(21) Appl. No.: **29/136,993**

(22) Filed: **Feb. 12, 2001**

(51) **LOC (7) Cl.** **06-04**

(52) **U.S. Cl.** **D6/550**

(58) **Field of Search** D6/546-50, 518, D6/522-24; D8/300, 315-21, 354, 363, 373, 380; 108/28-29; 211/13.1, 16, 60.1, 86.01, 87.01, 88.04, 100, 105.1-105.2, 123, 181.1, 182; 248/175, 176.1, 251, 302; 16/110.1, 412, 415; 242/570, 590, 595-598; 206/389

(56) **References Cited**

U.S. PATENT DOCUMENTS

- D. 337,230 * 7/1993 Wang D6/550
- D. 388,644 * 1/1998 Chen D6/550
- D. 391,831 * 3/1998 Doughty et al. D8/321
- D. 394,971 * 6/1998 Moore D6/550
- D. 416,419 * 11/1999 Chen D6/550
- D. 418,345 * 1/2000 Chen D6/550
- D. 424,346 * 5/2000 Chen D6/524
- D. 432,840 * 10/2000 Solowiej D6/549

D. 433,618 * 11/2000 Bredemeier D8/363

* cited by examiner

Primary Examiner—Brian N. Vinson

(74) *Attorney, Agent, or Firm*—Charles E. Baxley

(57) **CLAIM**

The ornamental design for a towel bar post, as shown and described.

DESCRIPTION

FIG. 1 is a perspective view of a towel bar post showing my new new design;
 FIG. 2 is a front elevational view thereof;
 FIG. 3 is a rear elevational view thereof;
 FIG. 4 is a left side elevational view thereof; the right side elevational view being identical to that shown;
 FIG. 5 is a top plan view thereof;
 FIG. 6 is a bottom plan view thereof;
 FIG. 7 is a reduced perspective view thereof, the broken-line disclosure of a cap being for illustrative purposes only and forming no part of the claimed design;
 FIG. 8 is a reduced perspective view thereof, the broken-line disclosure of a towel bar being for illustrative purposes only and forming no part of the claimed design; and,
 FIG. 9 is a reduced perspective view thereof, the broken-line disclosure of a towel bar being for illustrative purposes only and forming no part of the claimed design.

1 Claim, 7 Drawing Sheets

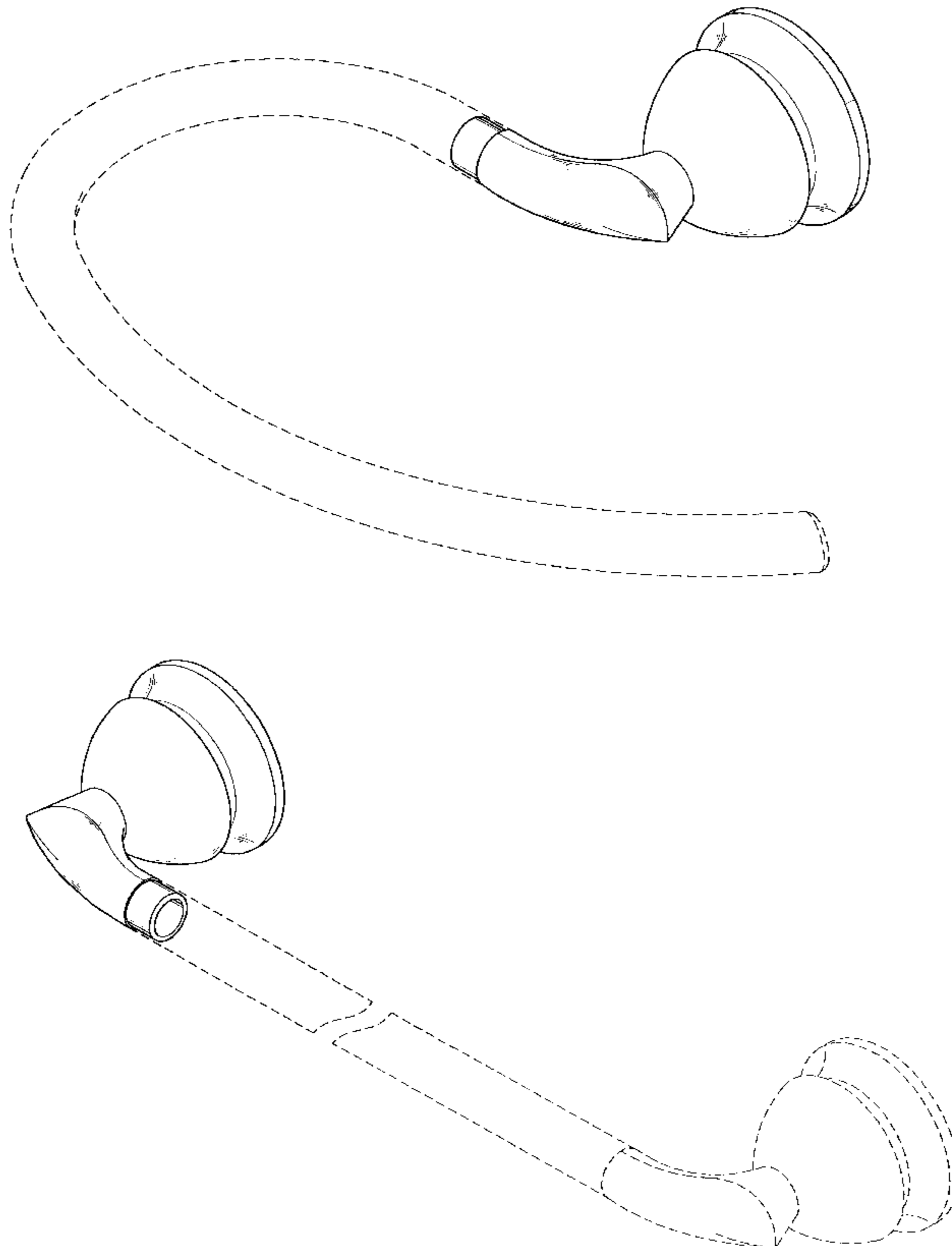

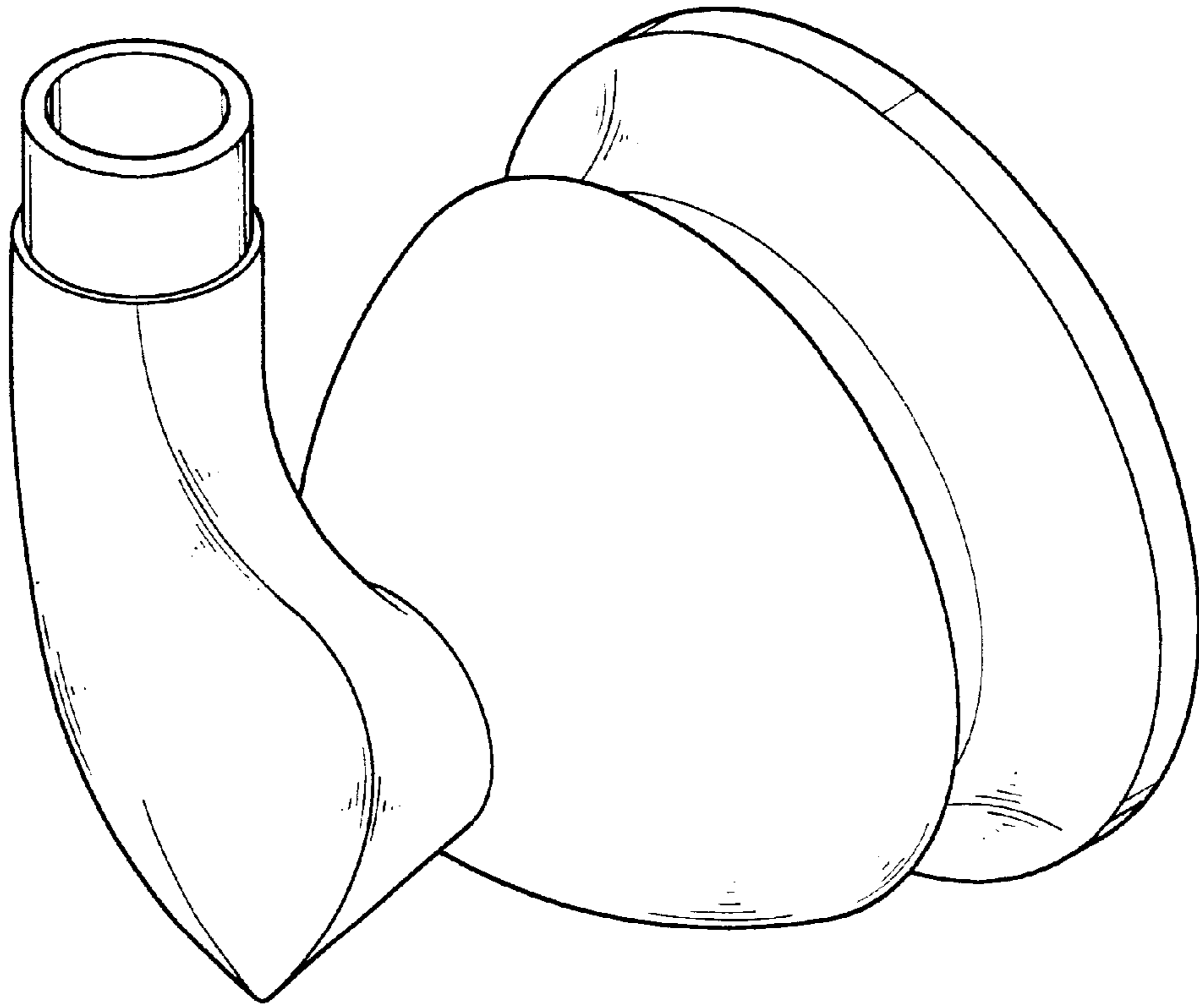

FIG. 1

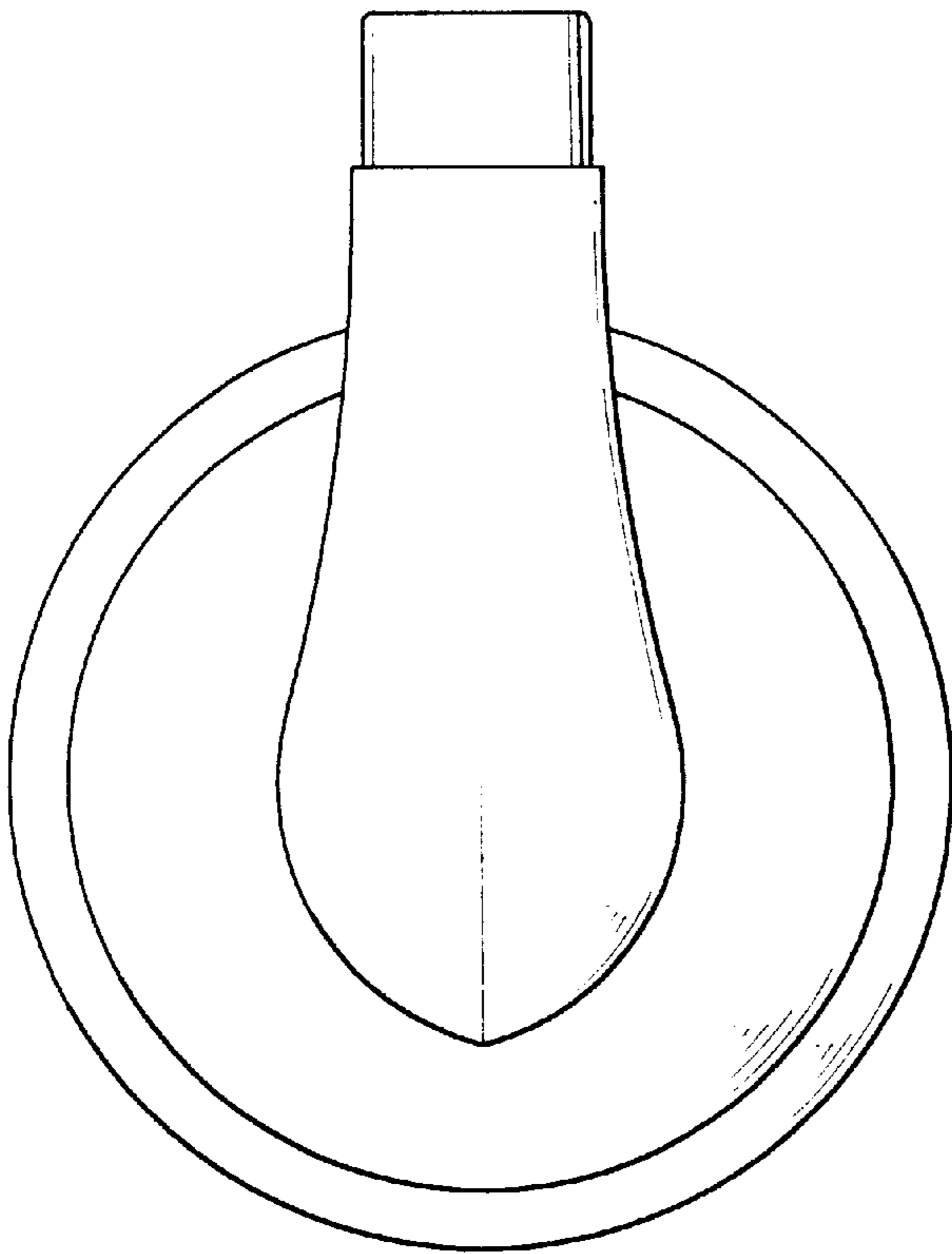

FIG. 2

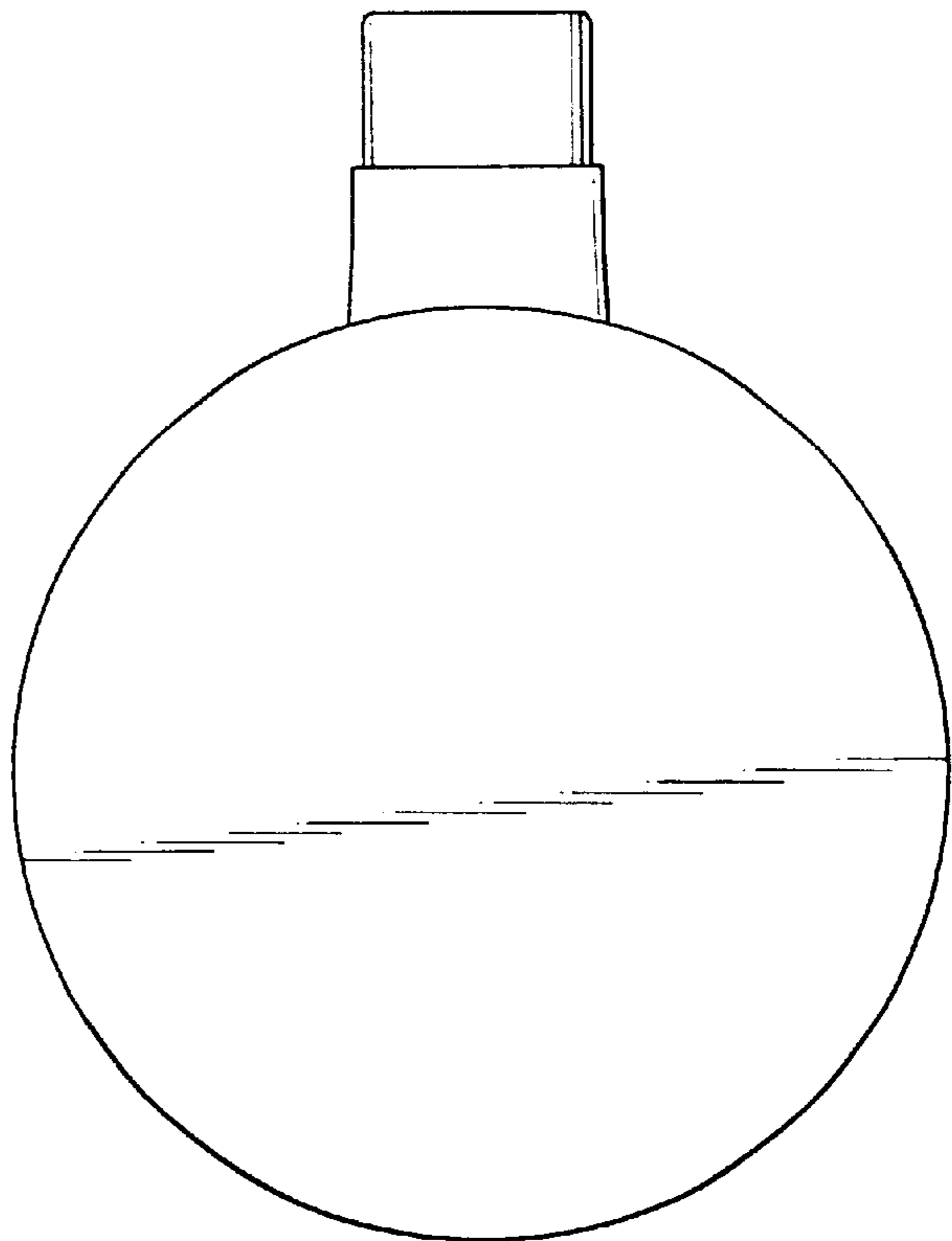

FIG. 3

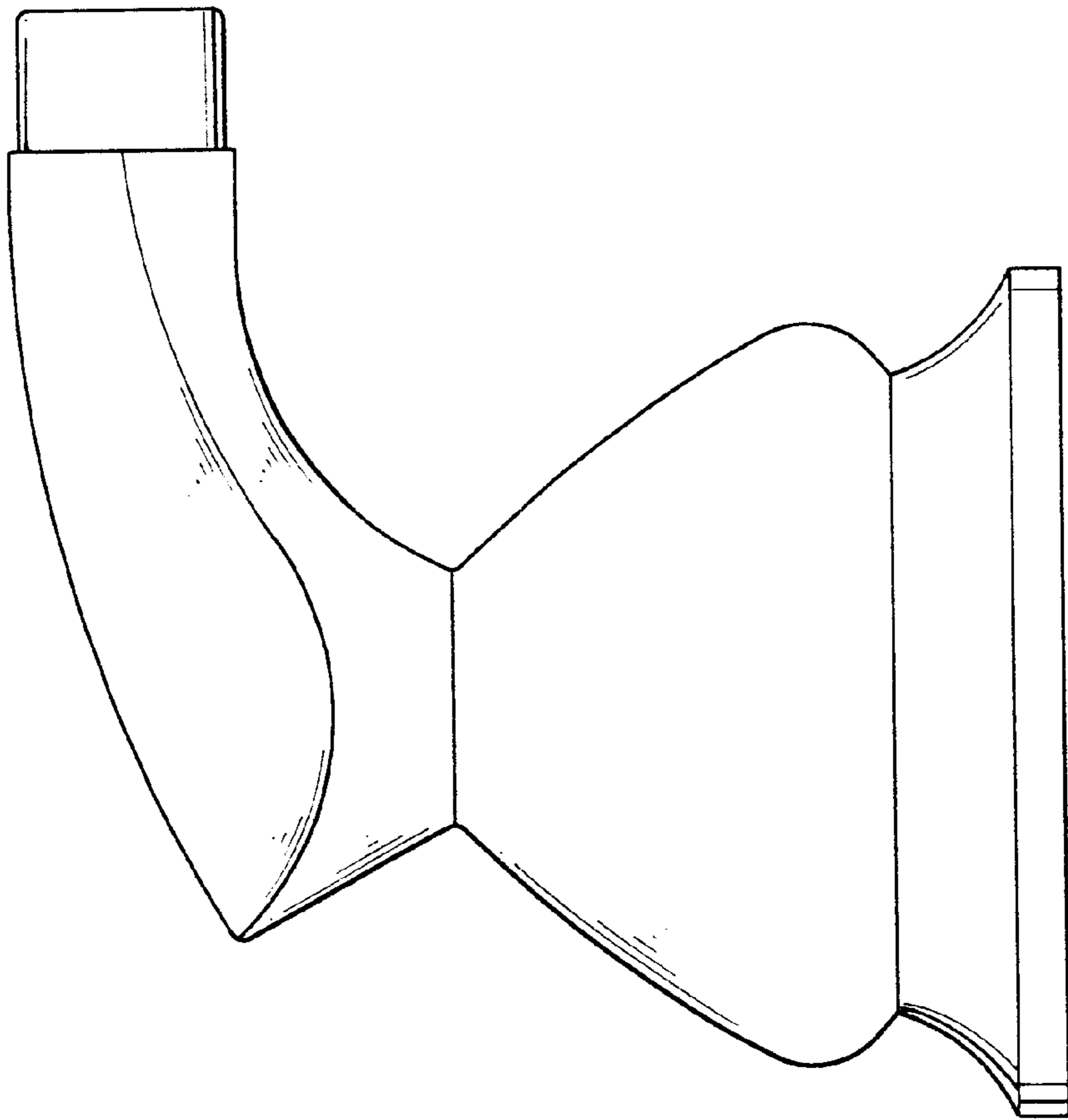

FIG. 4

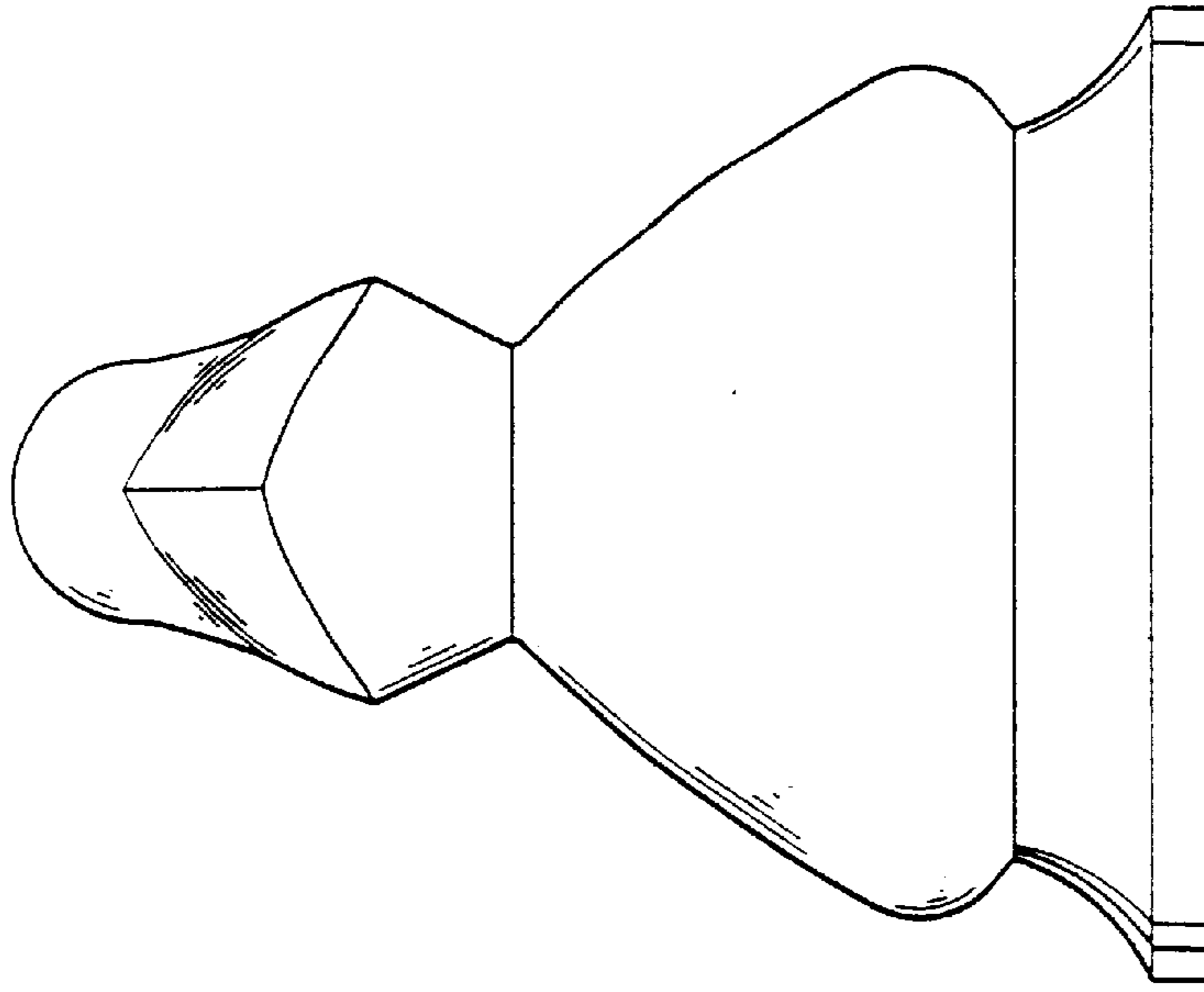

FIG. 6

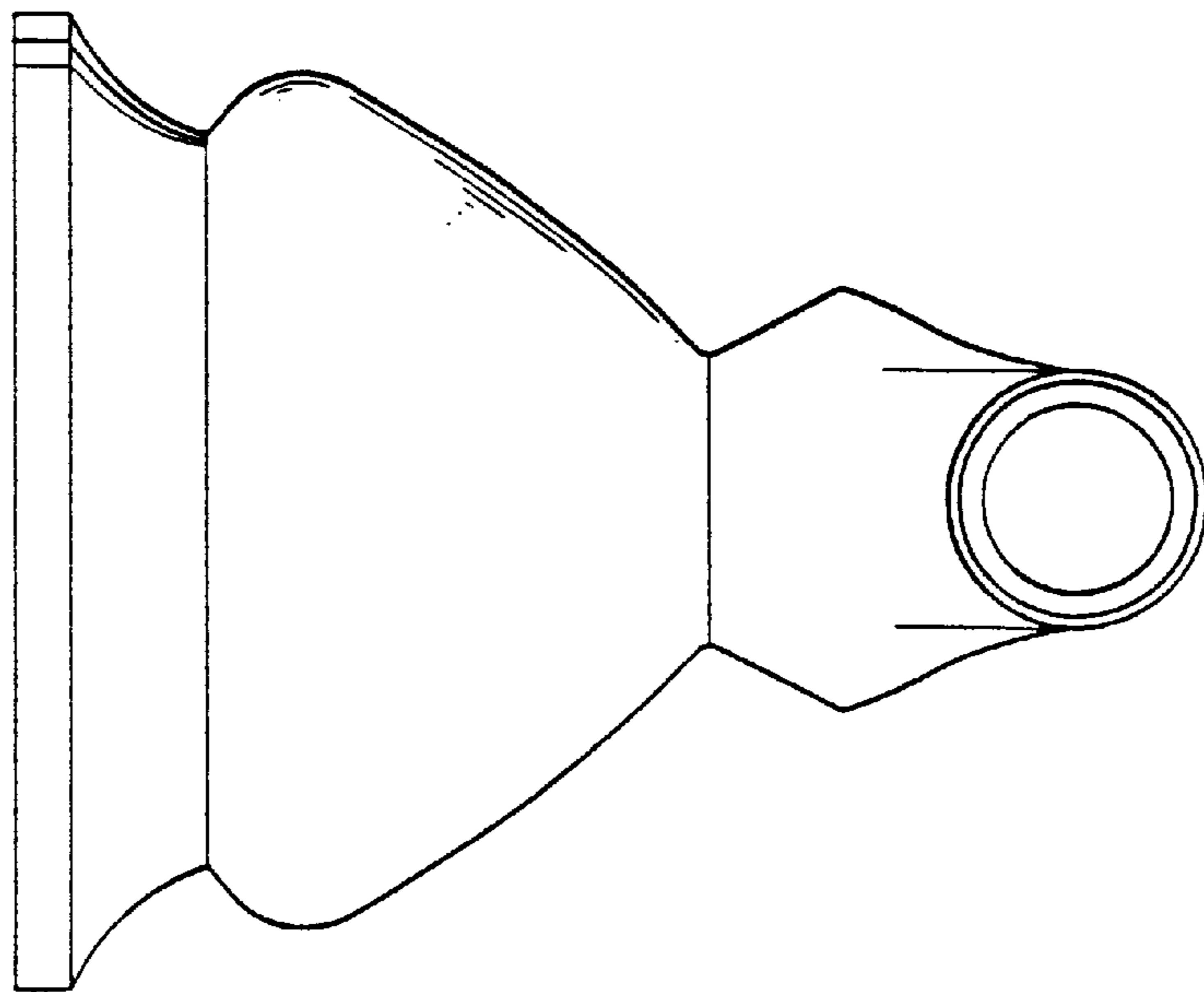

FIG. 5

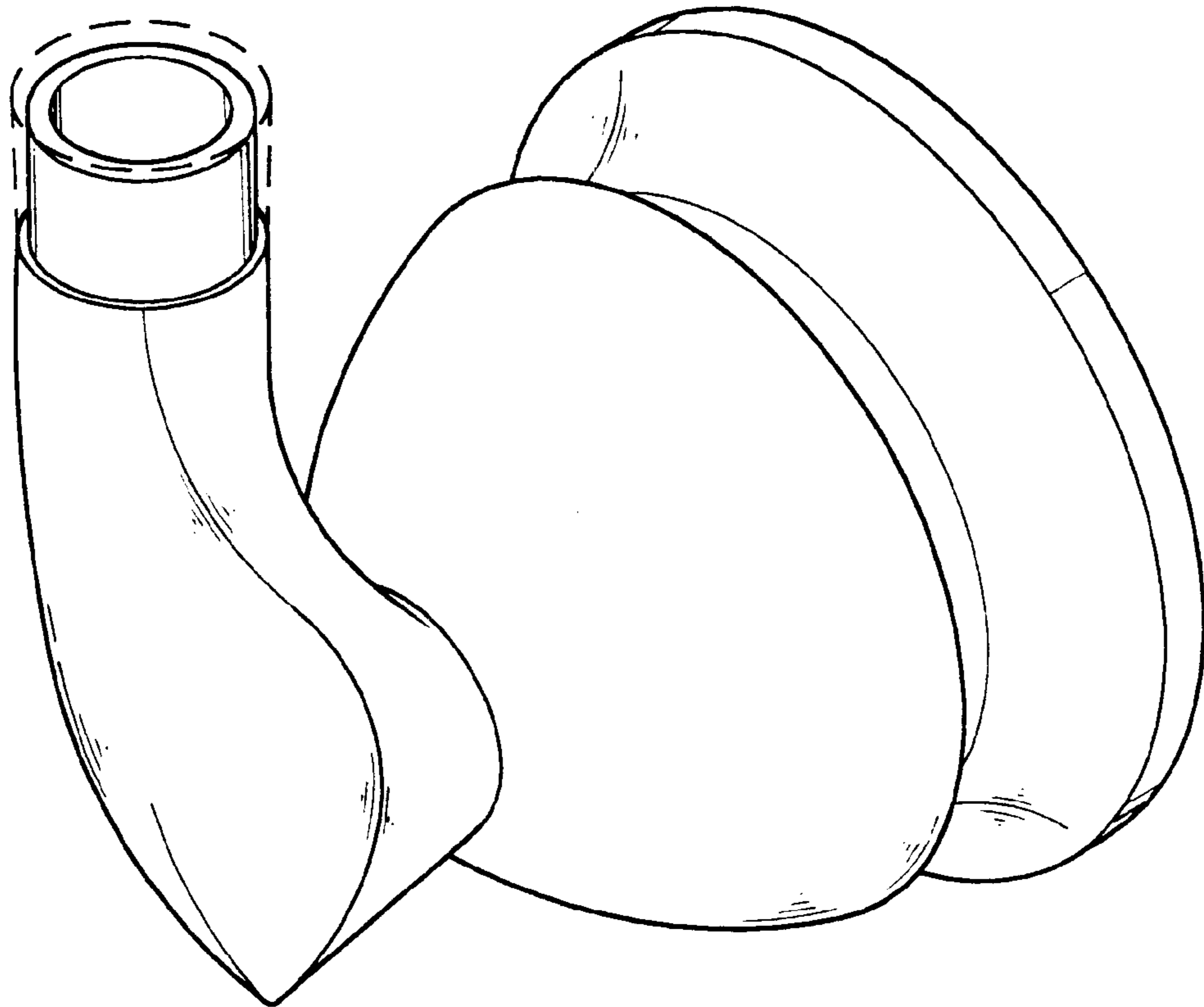

FIG. 7

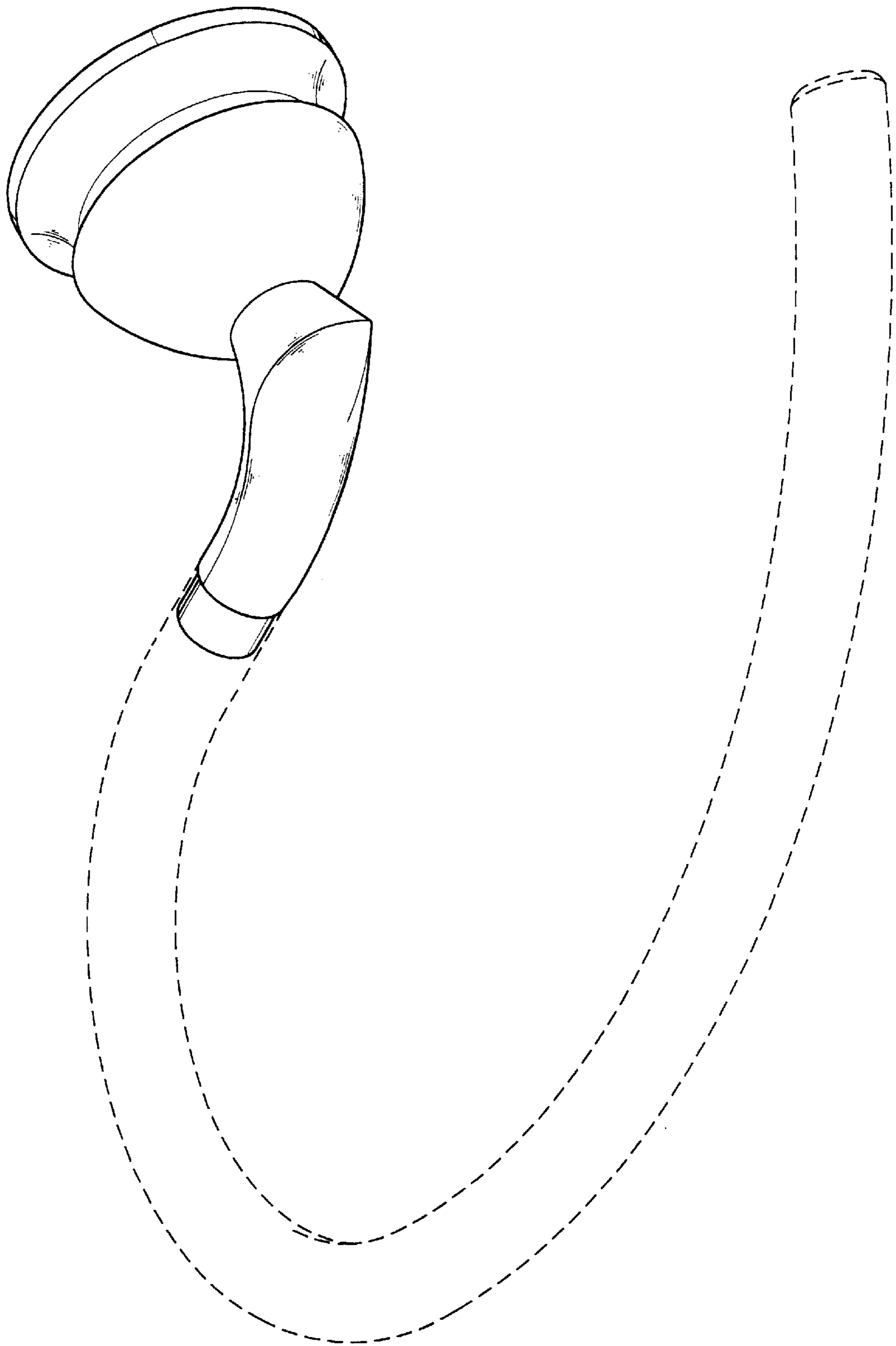

FIG. 8

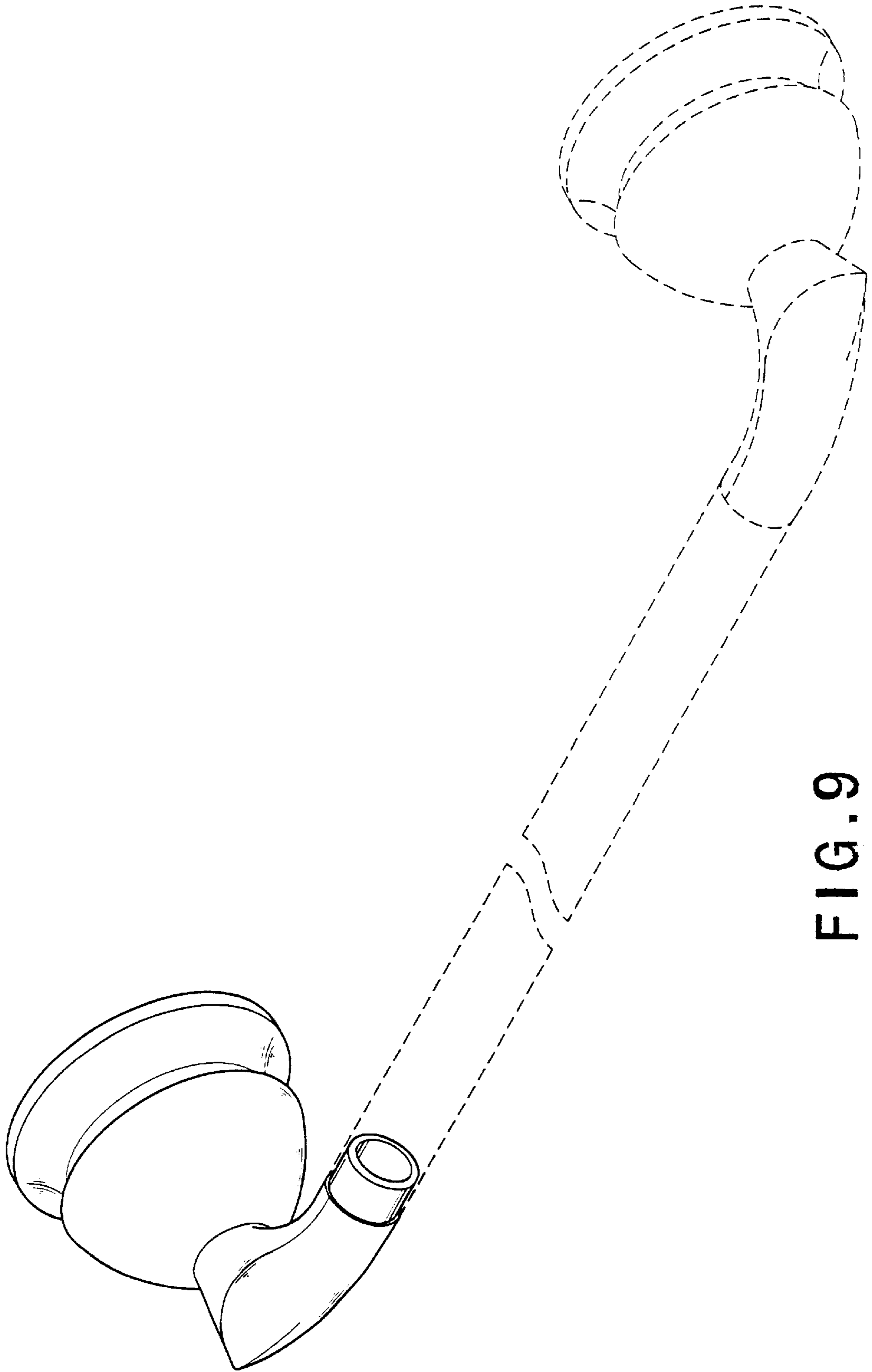

FIG. 9