



US00D452294B1

(12) **United States Design Patent**
Harthorn et al.

(10) **Patent No.:** **US D452,294 S**

(45) **Date of Patent:** **** Dec. 18, 2001**

(54) **HYDRAULIC FLUID TANK**

(76) Inventors: **Duane A. Harthorn**, 13762 Highway 225 E., Lynnville, IA (US) 50193; **Fred H. Lucas**, 23877 220th Ave., Sigourney, IA (US) 52591

(**) Term: **14 Years**

(21) Appl. No.: **29/125,472**

(22) Filed: **Jun. 22, 2000**

(51) **LOC (7) Cl.** **23-01**

(52) **U.S. Cl.** **D23/202; D12/95**

(58) **Field of Search** **D23/202, 203; 220/565-7, 4.12; D12/95**

(56) **References Cited**

U.S. PATENT DOCUMENTS

D. 186,660	*	11/1959	Maybaum et al.	D23/202
D. 216,309	*	12/1969	Halaby et al.	D23/202
D. 270,856	*	10/1983	Peets et al.	D23/202
D. 320,836	*	10/1991	Ahrenholtz et al.	D23/202

* cited by examiner

Primary Examiner—Robin V. Taylor
(74) *Attorney, Agent, or Firm*—Zarley, McKee, Thomte, Voorhees & Sease

(57) **CLAIM**

We claim the ornamental design for a hydraulic fluid tank, as shown and described.

DESCRIPTION

FIG. 1 is a perspective view of the design from a vantage point looking down upon the right front of the design.
FIG. 2 is a perspective view from a vantage point looking down at the right rear of the design.
FIG. 3 is a top plan view of FIG. 1.
FIG. 4 is a bottom plan view of FIG. 1.
FIG. 5 is a front elevation view of FIG. 1.
FIG. 6 is a left side elevation view of FIG. 1.
FIG. 7 is a right side elevation view of FIG. 1; and,
FIG. 8 is a back elevational view of FIG. 1.

The hydraulic fluid tank is normally positioned on framework, for example, the framework of a vehicle, such that the bottom of the tank is normally not seen.

1 Claim, 8 Drawing Sheets

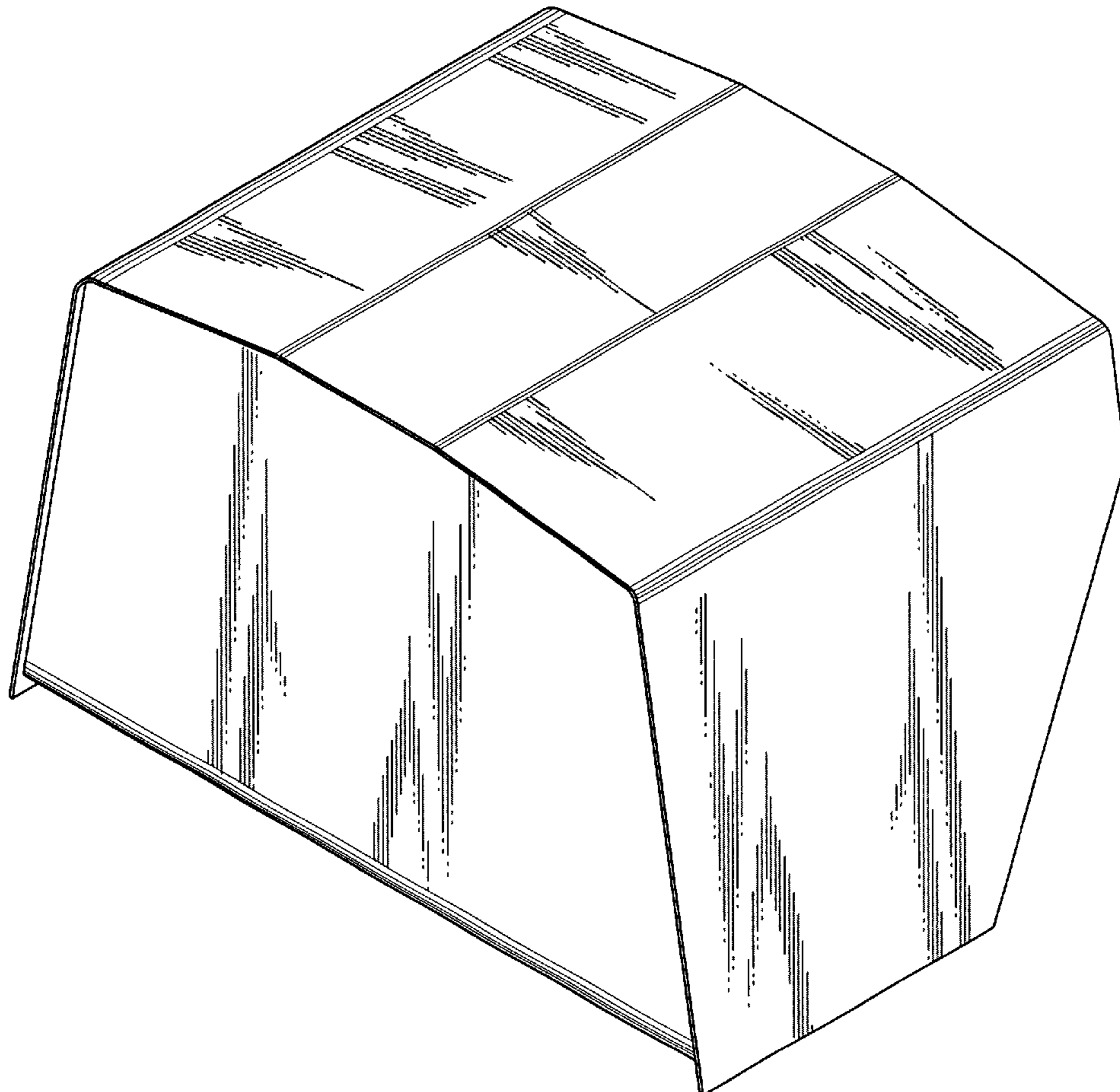

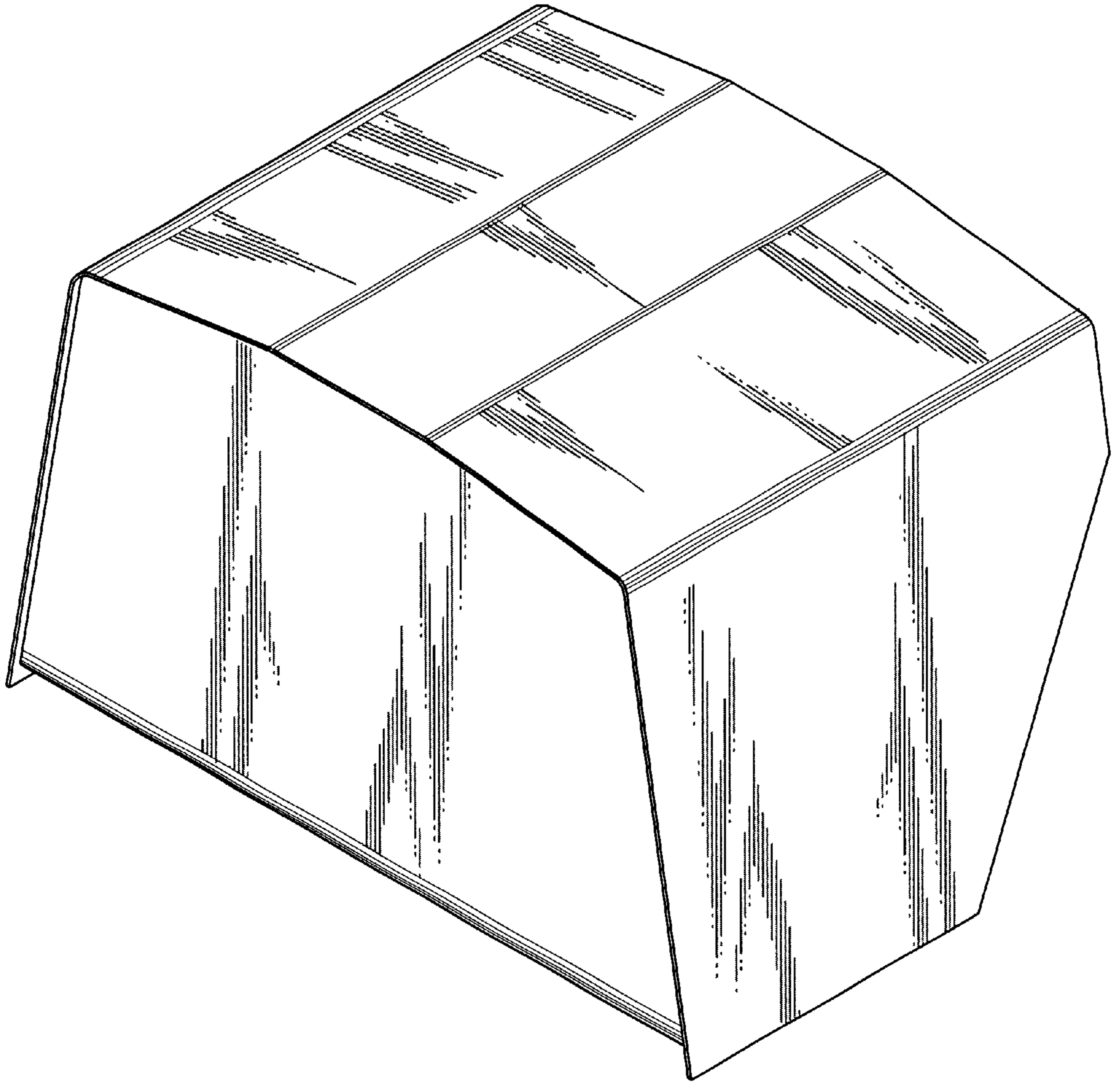

Fig. 1

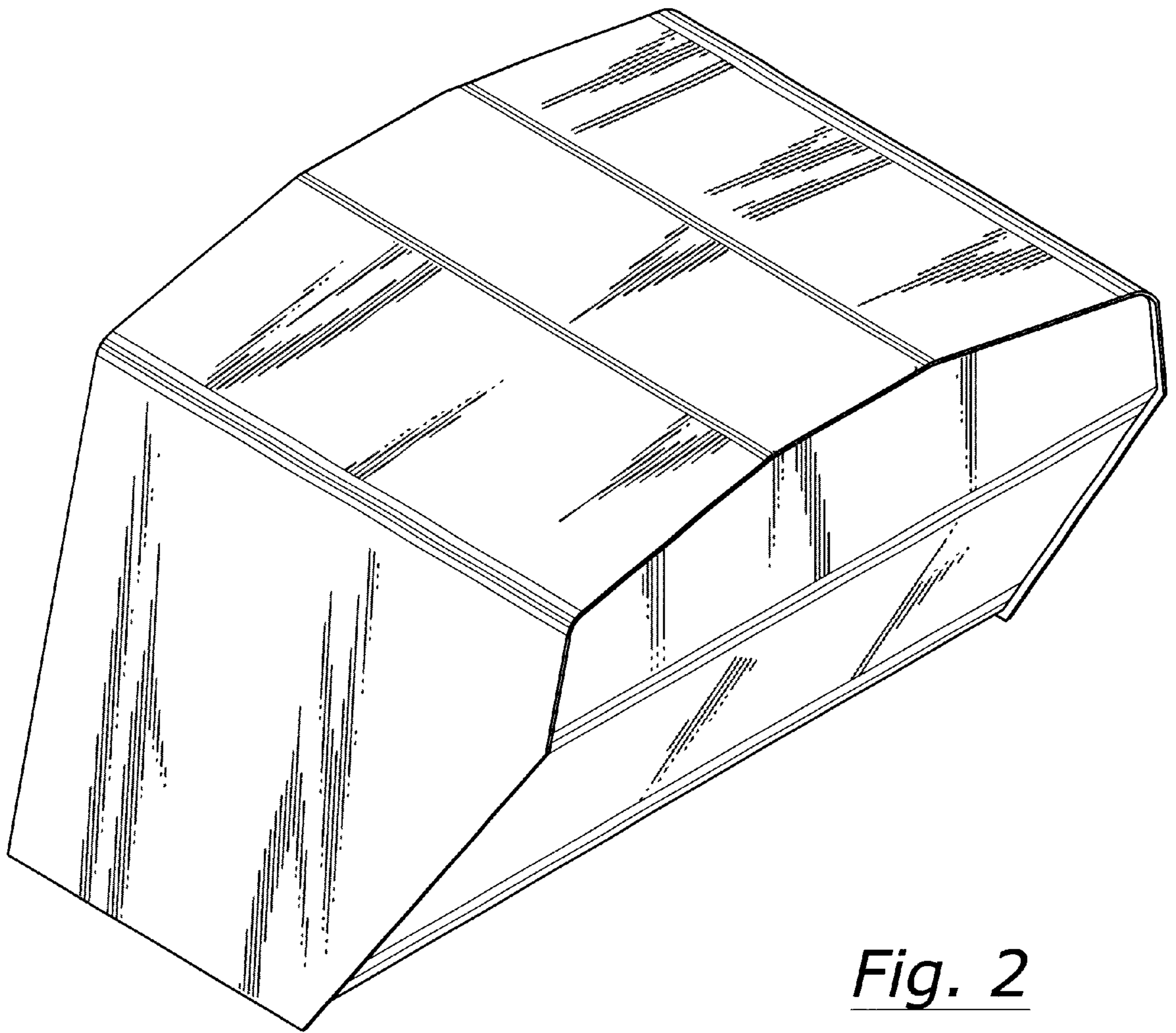

Fig. 2

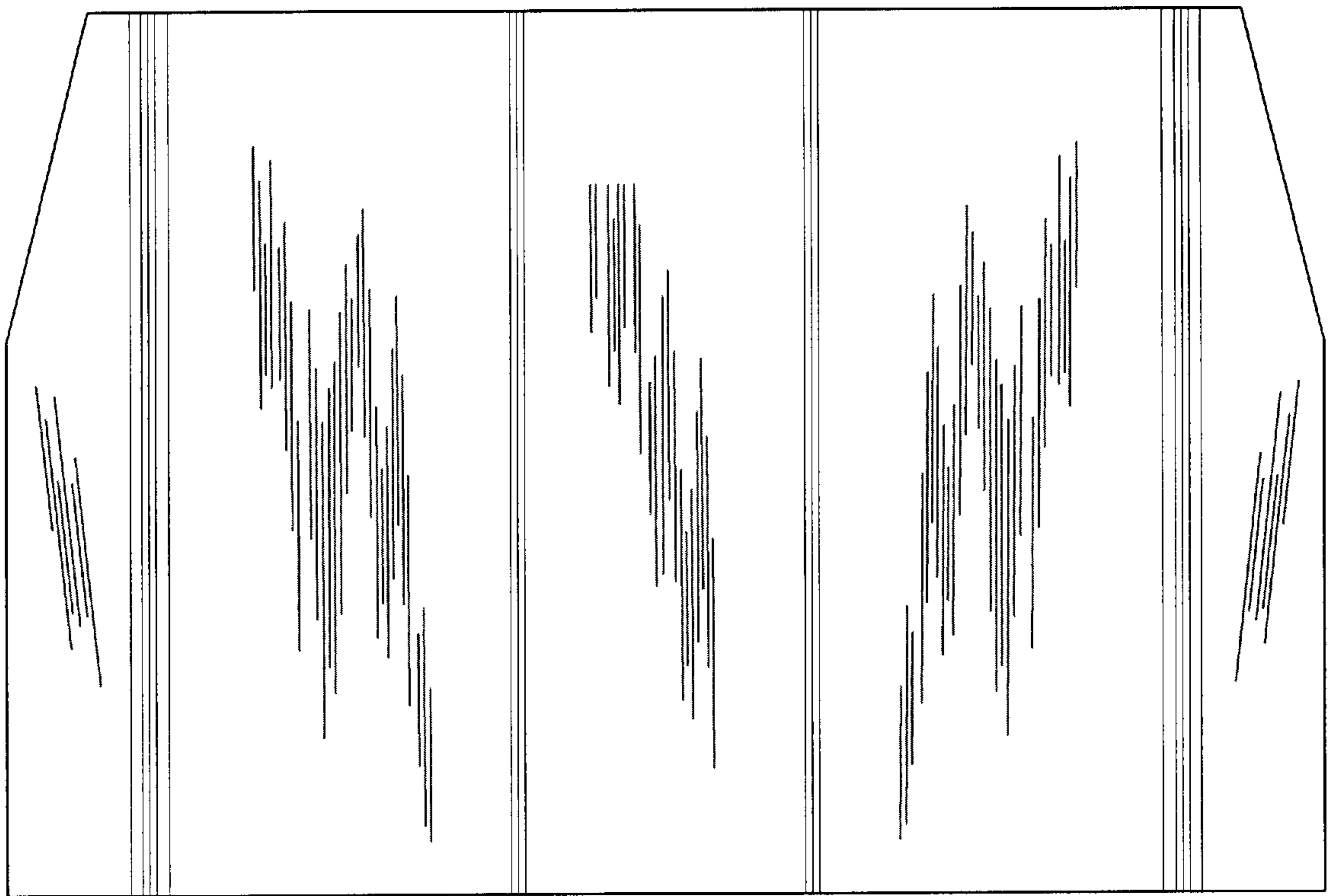

Fig. 3

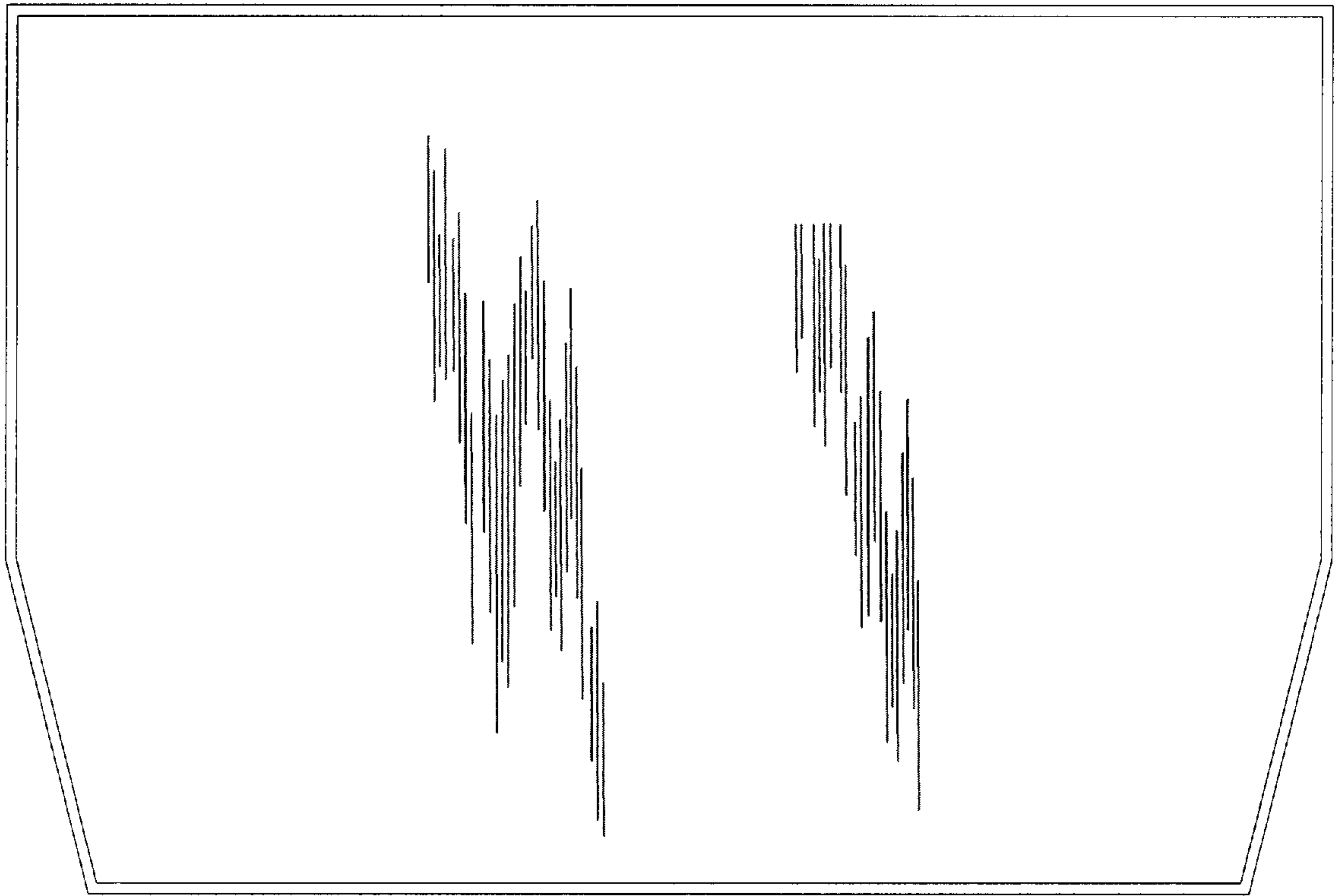

Fig. 4

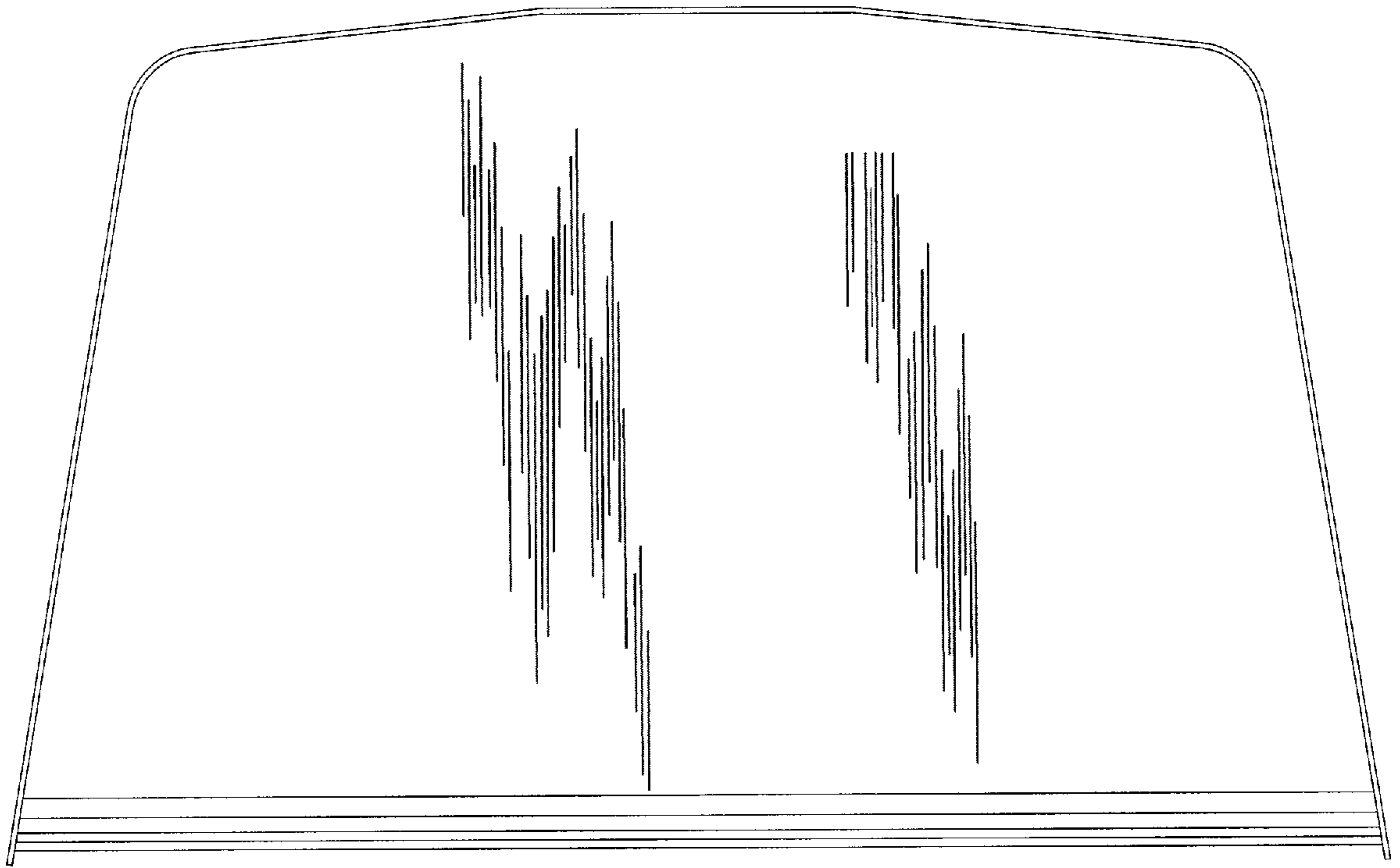

Fig. 5

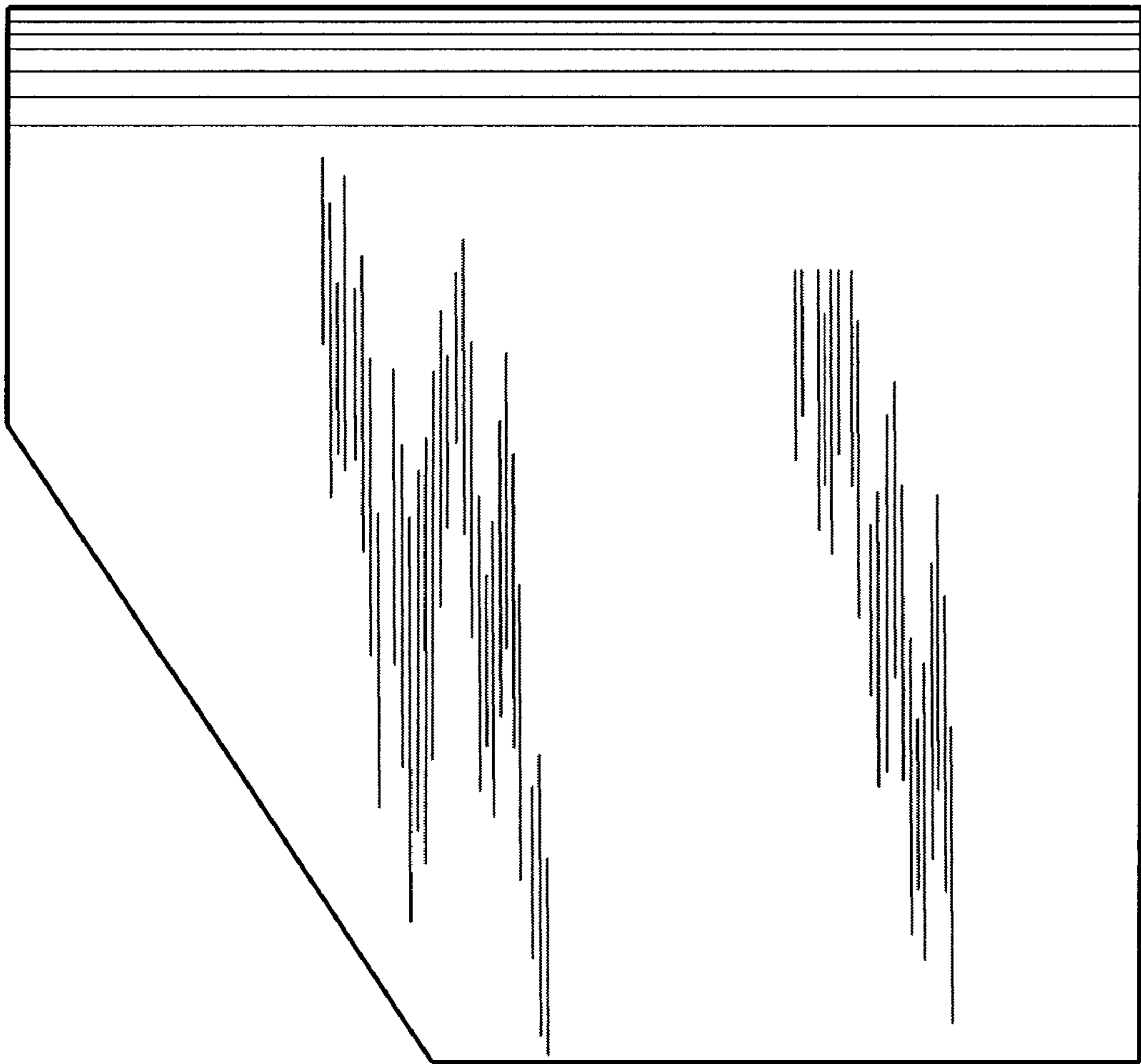

Fig. 6

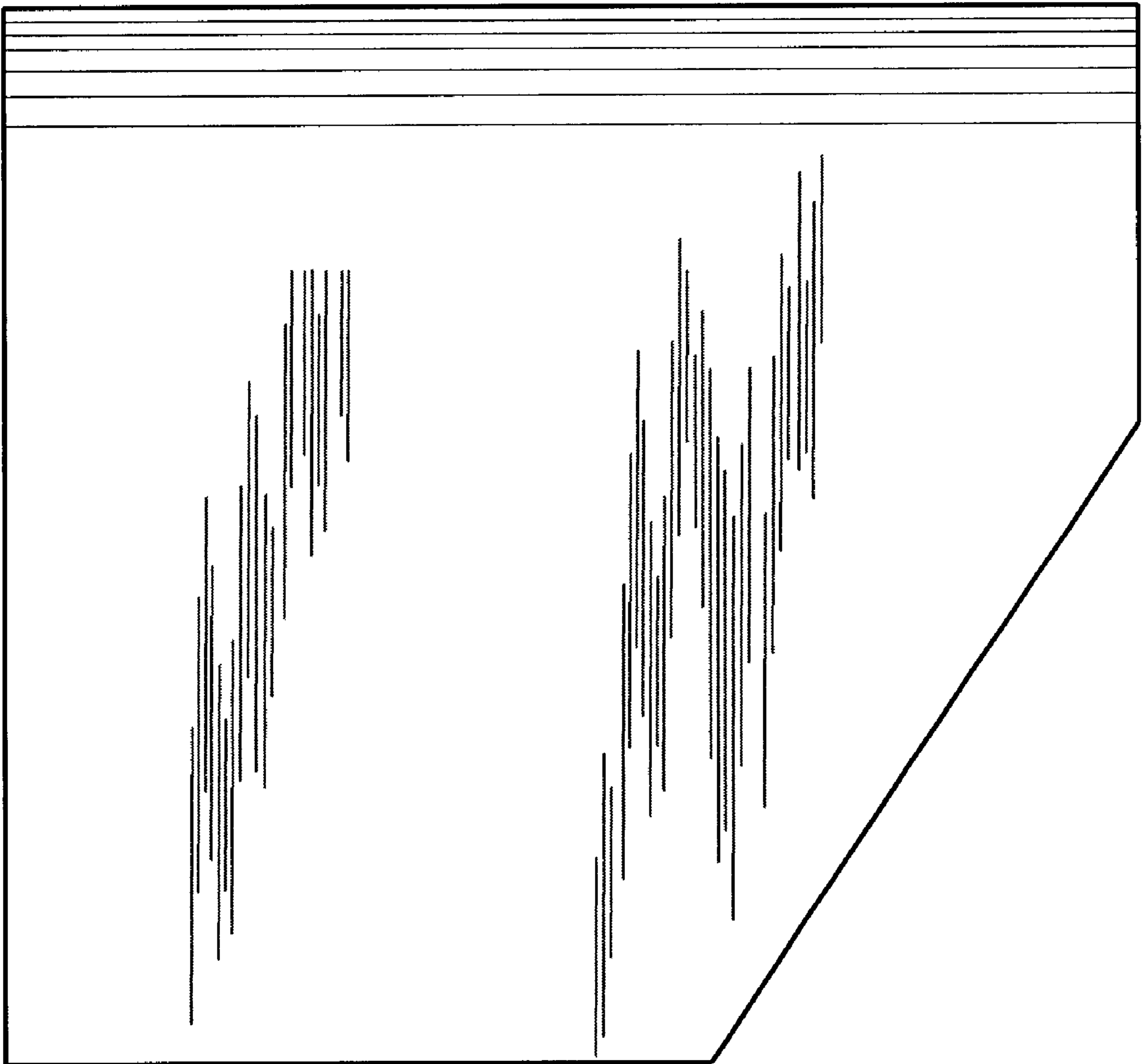

Fig. 7

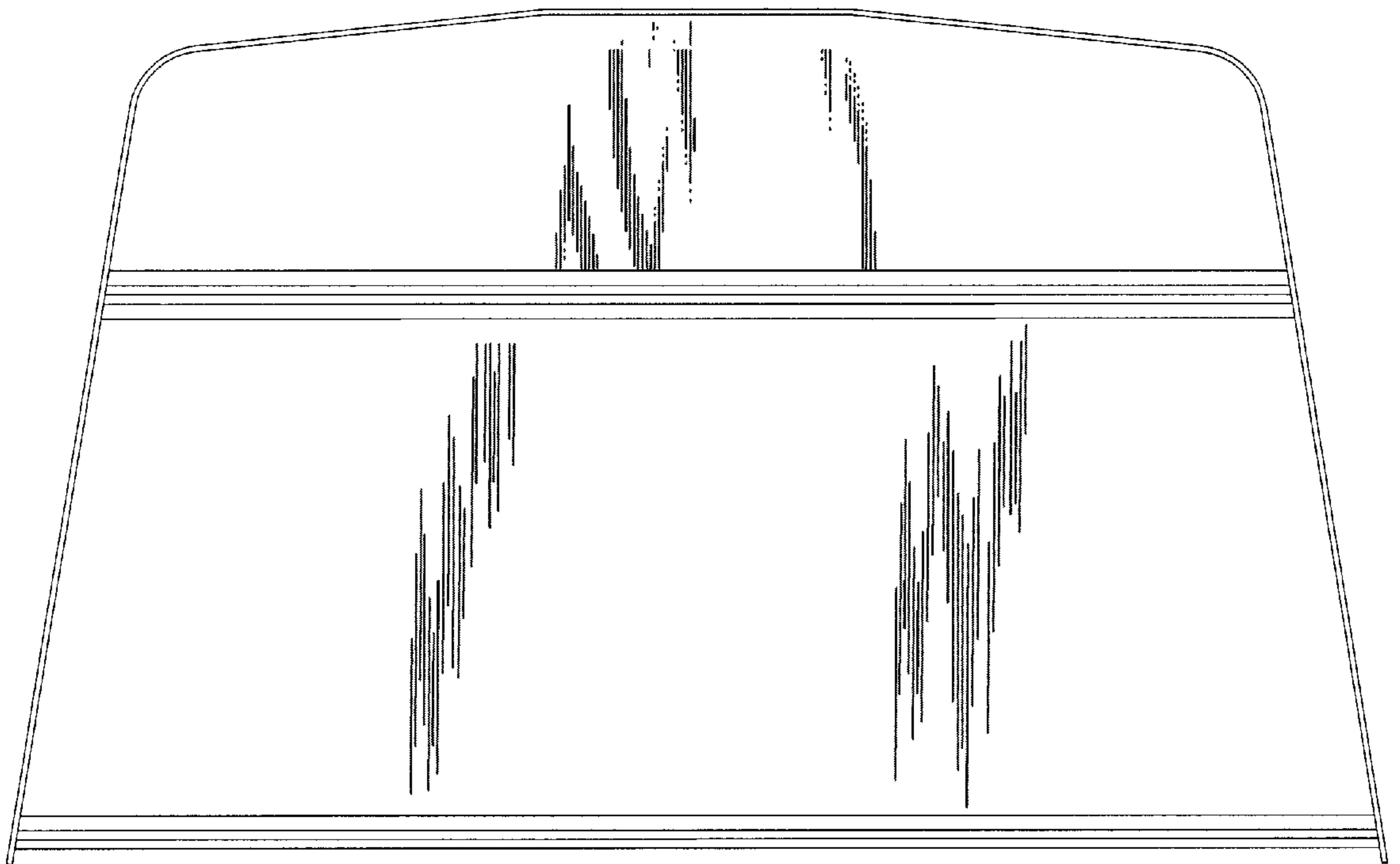

Fig. 8