



US00D452271B1

(12) **United States Design Patent**
Owen et al.

(10) **Patent No.:** **US D452,271 S**

(45) **Date of Patent:** **** Dec. 18, 2001**

(54) **WRITING INSTRUMENT**

2,473,689 * 6/1949 Colstad 24/11 R

(75) Inventors: **Kurt J. Owen**, Aurora, IL (US); **Marc Ian Drucker**, Brighton, MA (US)

OTHER PUBLICATIONS

Stabilo Boss Luminator marker, Feb. 2000.
Staedtler TextSurfer marker, Feb. 2000.

(73) Assignee: **Sanford**, Bellwood, IL (US)

* cited by examiner

(**) Term: **14 Years**

Primary Examiner—Martie K. Holtje

(21) Appl. No.: **29/128,421**

(74) *Attorney, Agent, or Firm*—Marshall, Gerstein, & Borun

(22) Filed: **Aug. 24, 2000**

(57) **CLAIM**

(51) **LOC (7) Cl.** **19-06**

The ornamental design for a “writing instrument”, as shown and described.

(52) **U.S. Cl.** **D19/43; D19/51; D19/56**

(58) **Field of Search** D19/35, 36, 41–51,
D19/53–58, 81–85; 401/202, 98, 209, 213,
243–247, 262; 24/10 R, 11 R

DESCRIPTION

(56) **References Cited**

FIG. 1 is a left side perspective view taken from the front and above showing our new design;
FIG. 2 is a top plan view thereof;
FIG. 3 is a bottom plan view thereof;
FIG. 4 is a rear elevational view thereof;
FIG. 5 is a front elevational view thereof; and,
FIG. 6 is right side elevational view, the left side being a mirror image thereof.

U.S. PATENT DOCUMENTS

- D. 343,418 * 1/1994 Dugelay D19/51
- D. 360,433 * 7/1995 Payne et al. D19/51
- D. 367,673 * 3/1996 Compte D19/51
- D. 368,930 * 4/1996 Payne D19/51
- D. 440,604 * 4/2001 Restrepo D19/51
- D. 441,398 * 5/2001 Owen et al. D19/49

1 Claim, 2 Drawing Sheets

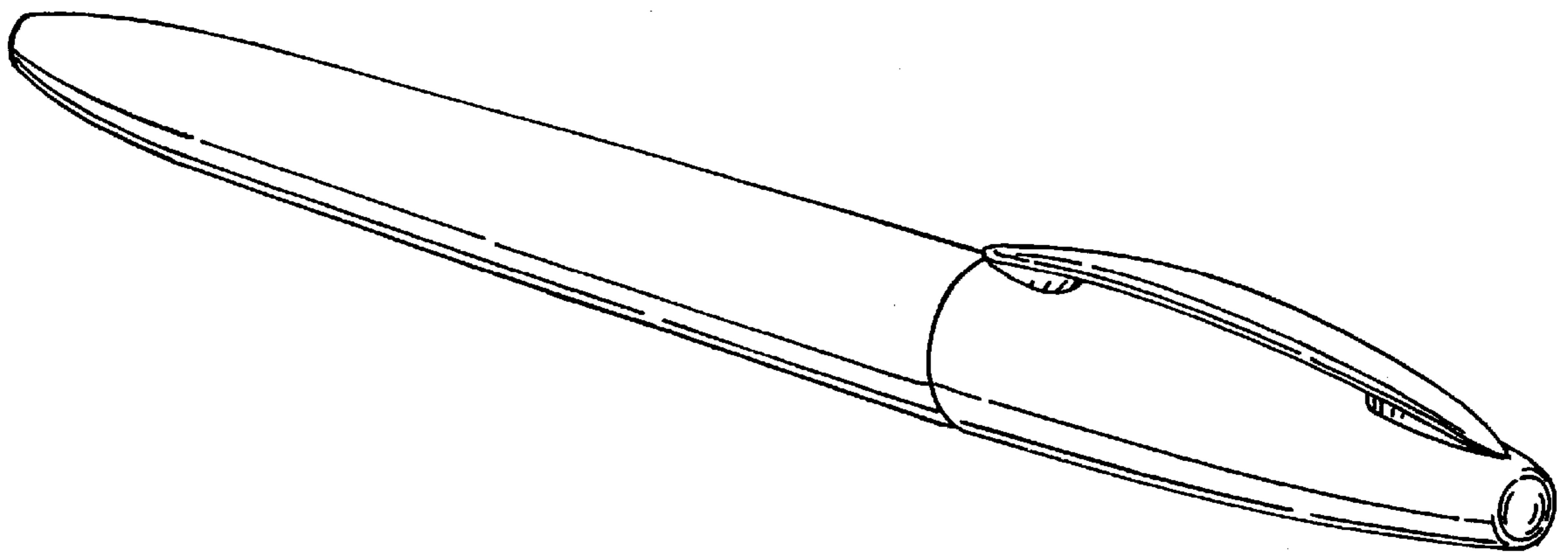

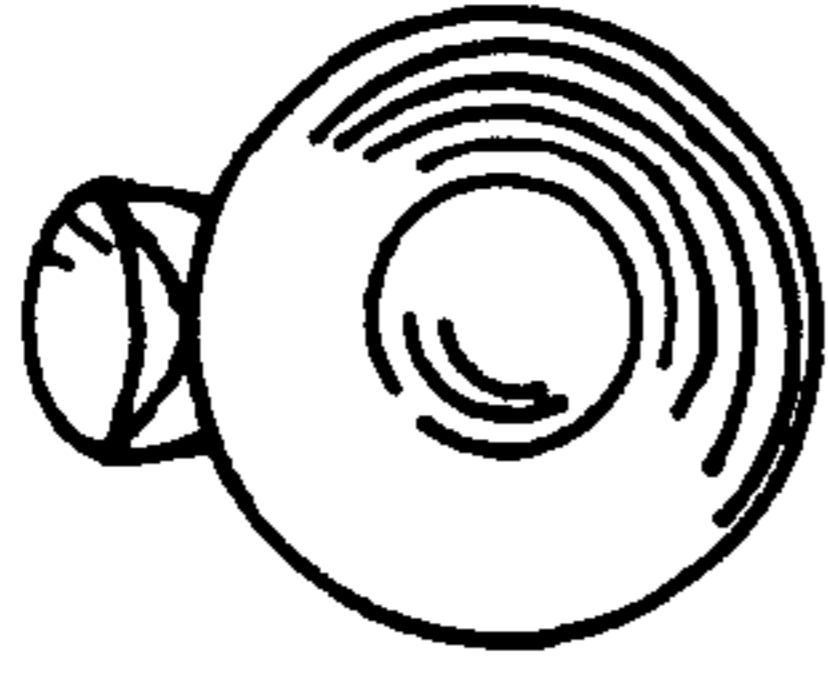
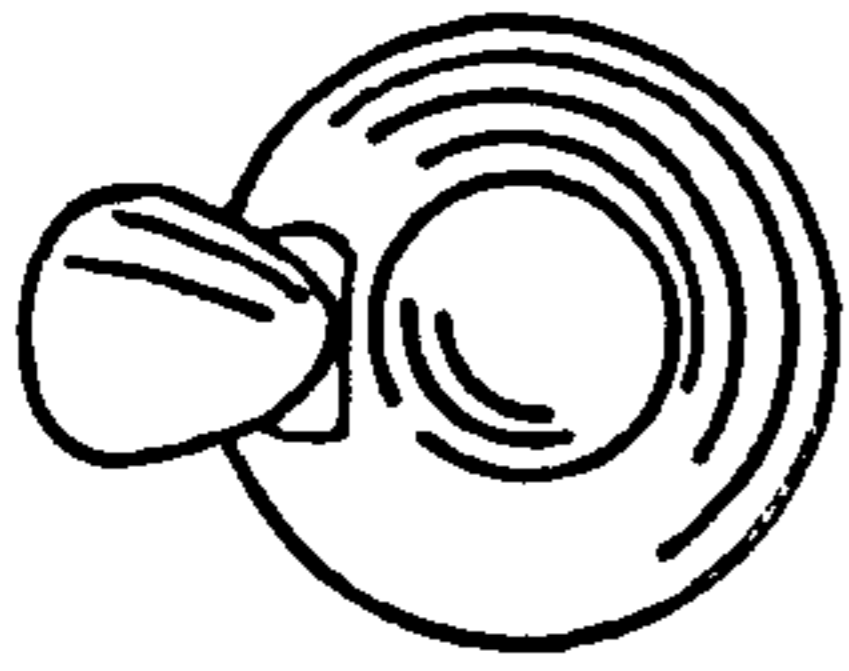

FIG. 2 FIG. 3

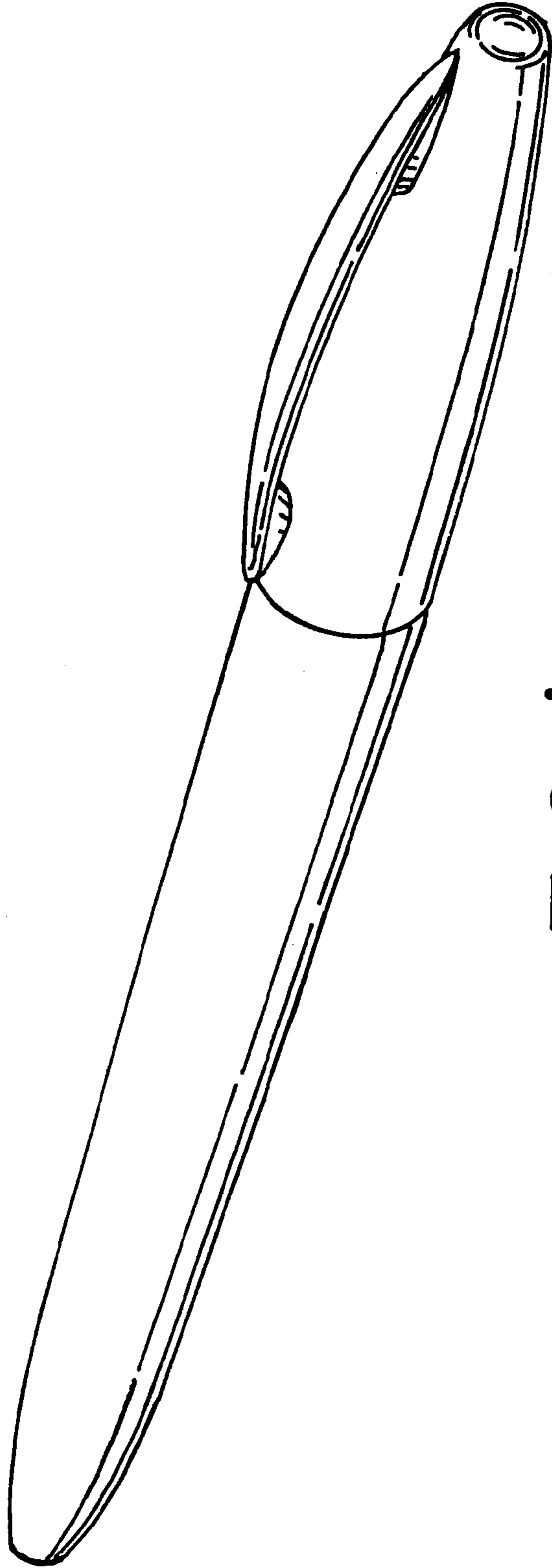

FIG. 1

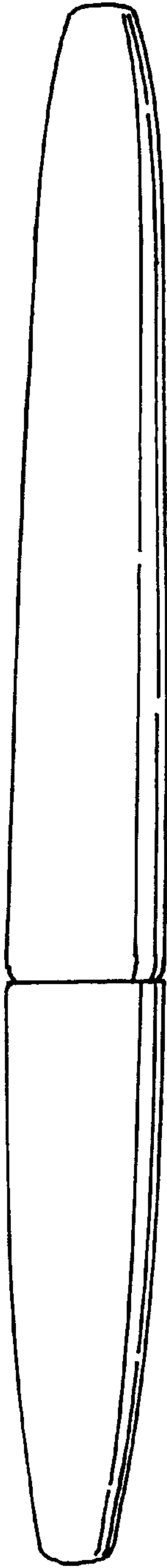

FIG. 4

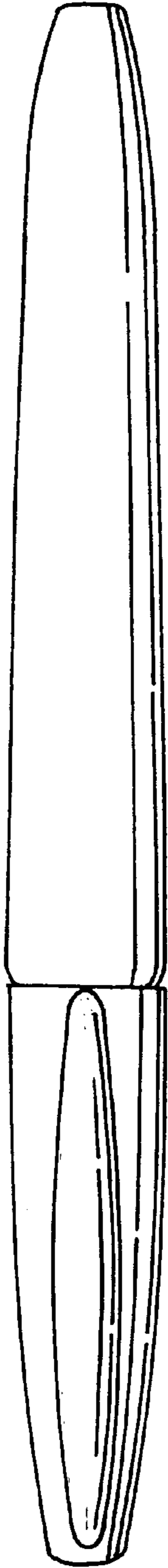

FIG. 5

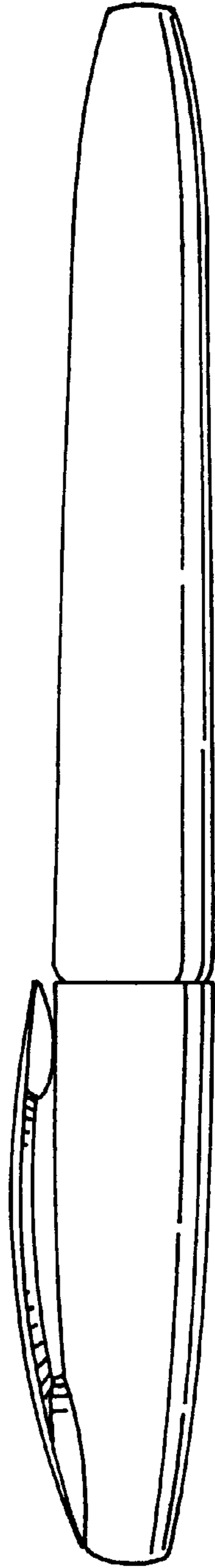

FIG. 6