



US00D452250B1

(12) **United States Design Patent**
Chan

(10) **Patent No.:** **US D452,250 S**

(45) **Date of Patent:** **** Dec. 18, 2001**

(54) **MP3 PLAYER**

(75) **Inventor:** **Ching Chan, Taipei (TW)**

(73) **Assignee:** **Perfect Union Co., Ltd., Taipei (TW)**

(**) **Term:** **14 Years**

(21) **Appl. No.:** **29/133,734**

(22) **Filed:** **Dec. 6, 2000**

(51) **LOC (7) Cl.** **14-03**

(52) **U.S. Cl.** **D14/496; D21/332**

(58) **Field of Search** D14/400, 401,
D14/435, 454, 496, 474, 483, 217; D21/332,
333; 273/148 B; 463/43-47, 1; 206/308.1,
308.3, 307; 369/24, 25, 2; 370/342, 343,
344

(56) **References Cited**

U.S. PATENT DOCUMENTS

- D. 377,648 * 1/1997 Young D14/136
- D. 381,647 * 7/1997 Terng D14/217
- D. 421,255 * 2/2000 Hisatsune et al. D14/125
- D. 437,860 * 2/2001 Suzuki et al. D14/496

- D. 438,179 * 2/2001 Wang-Tsai D14/496
- 4,976,435 * 12/1990 Shatford et al. 345/156
- 5,192,082 * 3/1993 Inoue et al. 463/44
- 5,964,661 * 10/1999 Dodge 273/148 B X
- 6,230,885 * 5/2001 Rochelo et al. 206/308.3

* cited by examiner

Primary Examiner—Prabhakar Deshmukh

(74) *Attorney, Agent, or Firm*—Dougherty & Troxell

(57) **CLAIM**

The ornamental design for MP3 player, as shown and described.

DESCRIPTION

FIG. 1 is a top front and left side perspective view of MP3 player showing my new design;
 FIG. 2 is a front elevational view thereof;
 FIG. 3 is a rear elevational view thereof;
 FIG. 4 is a left side elevational view thereof;
 FIG. 5 is a right side elevational view thereof;
 FIG. 6 is a top plan view thereof; and,
 FIG. 7 is a bottom plan view thereof.

1 Claim, 4 Drawing Sheets

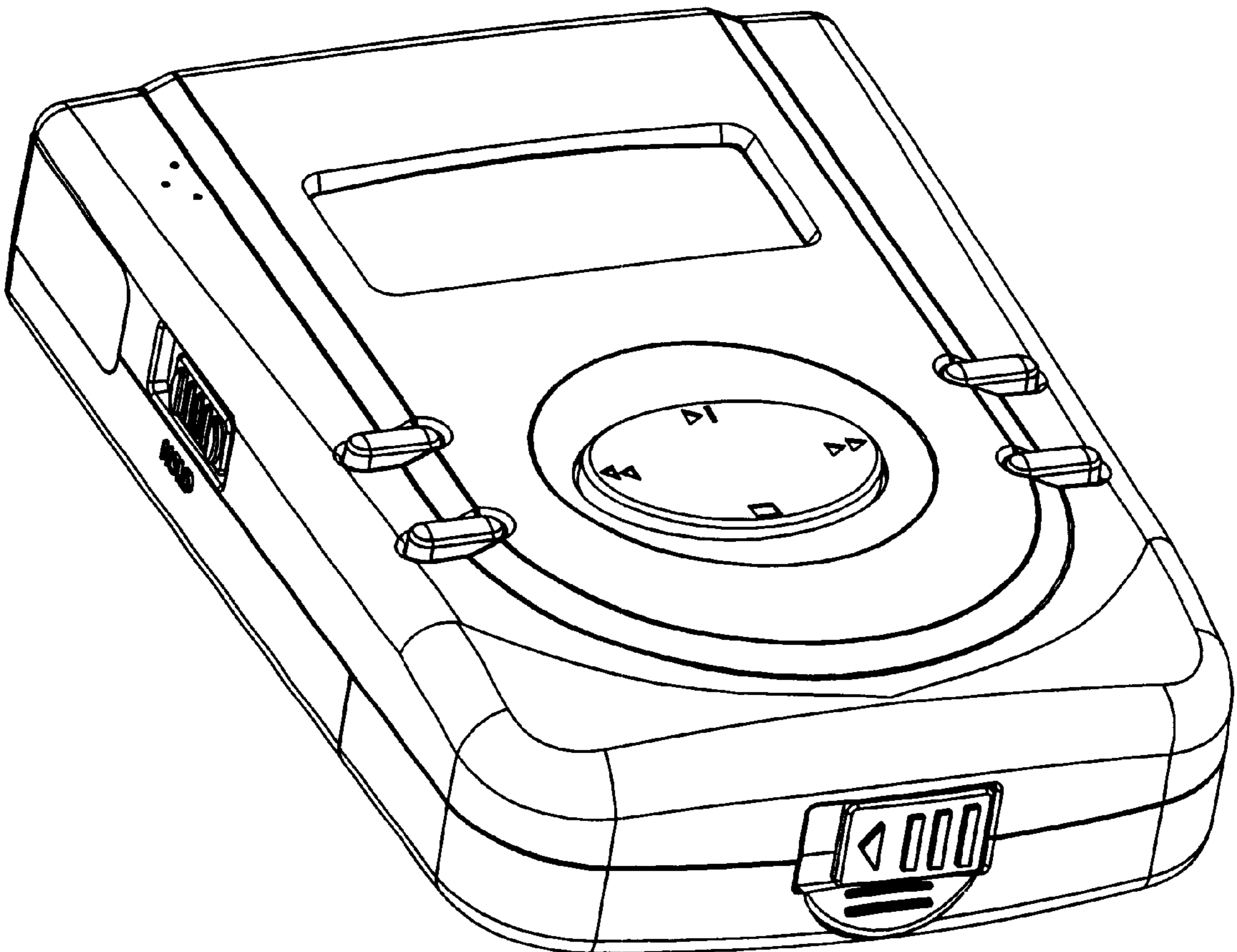

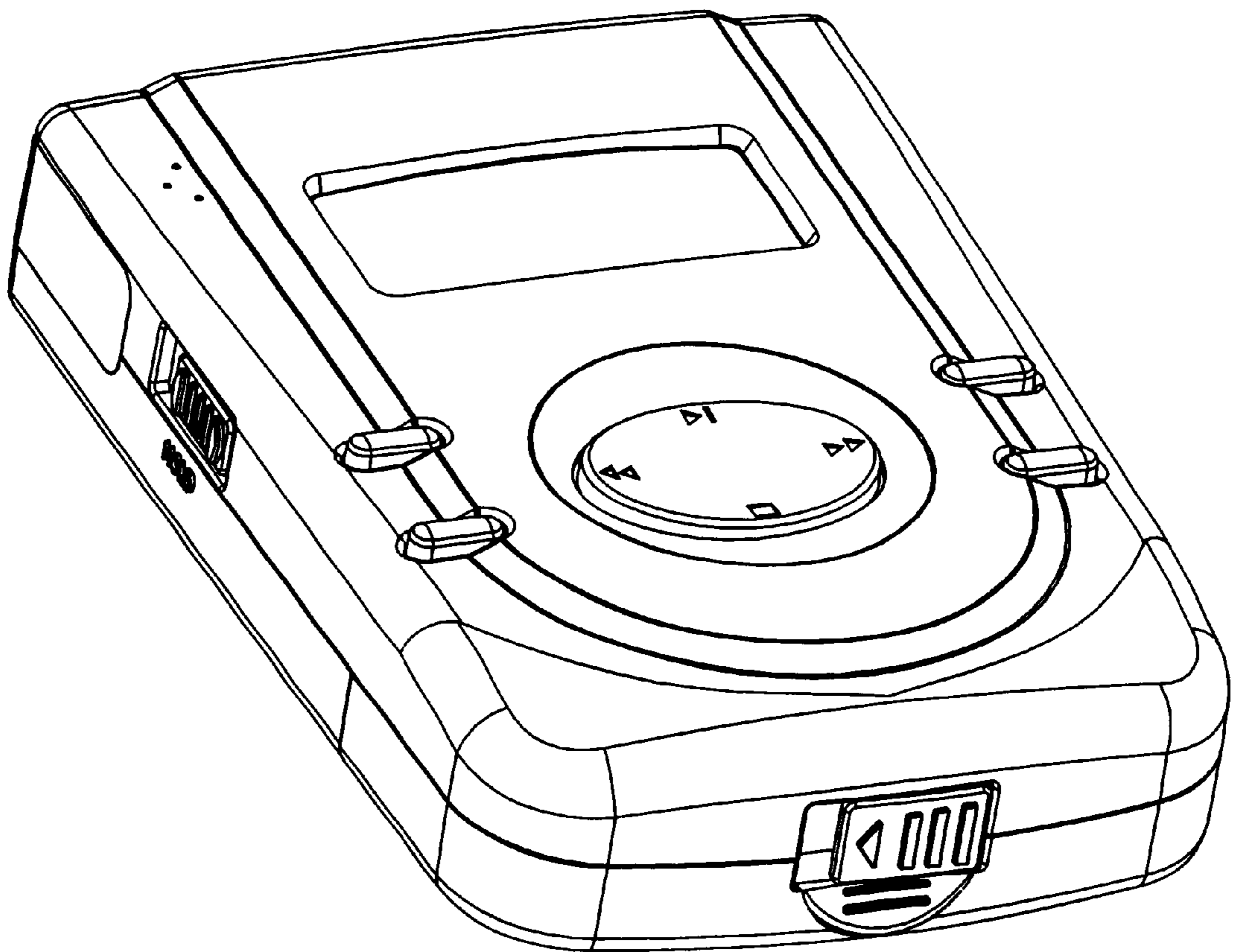

Fig. 1

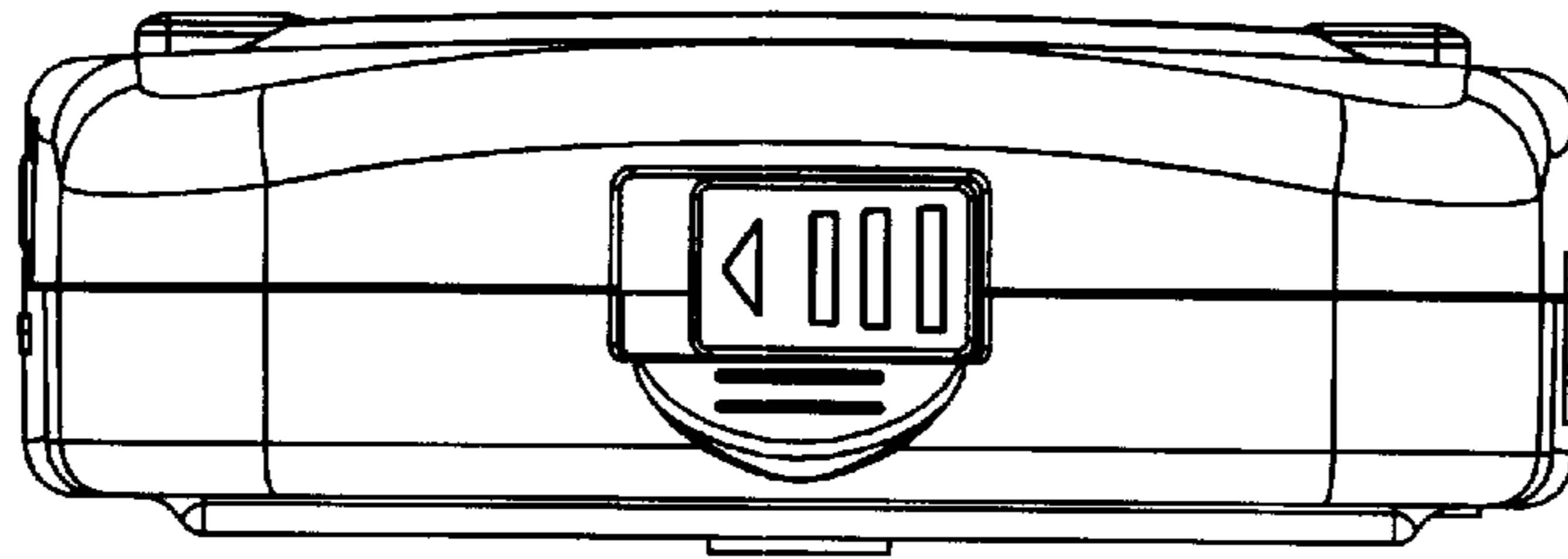

Fig. 2

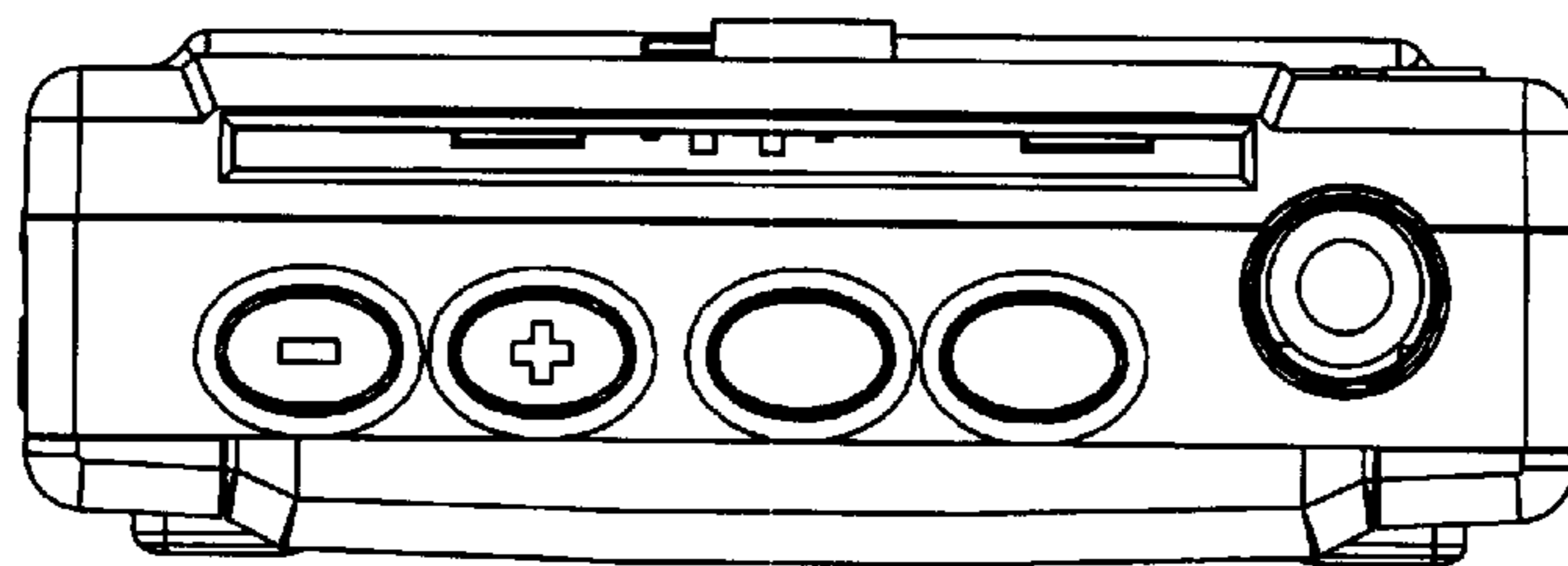

Fig. 3

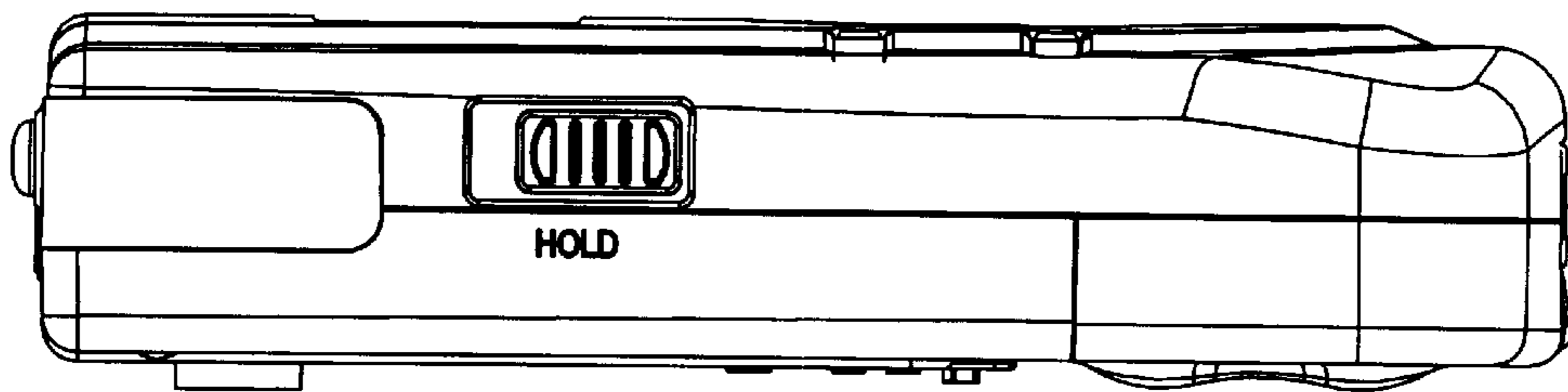

Fig. 4

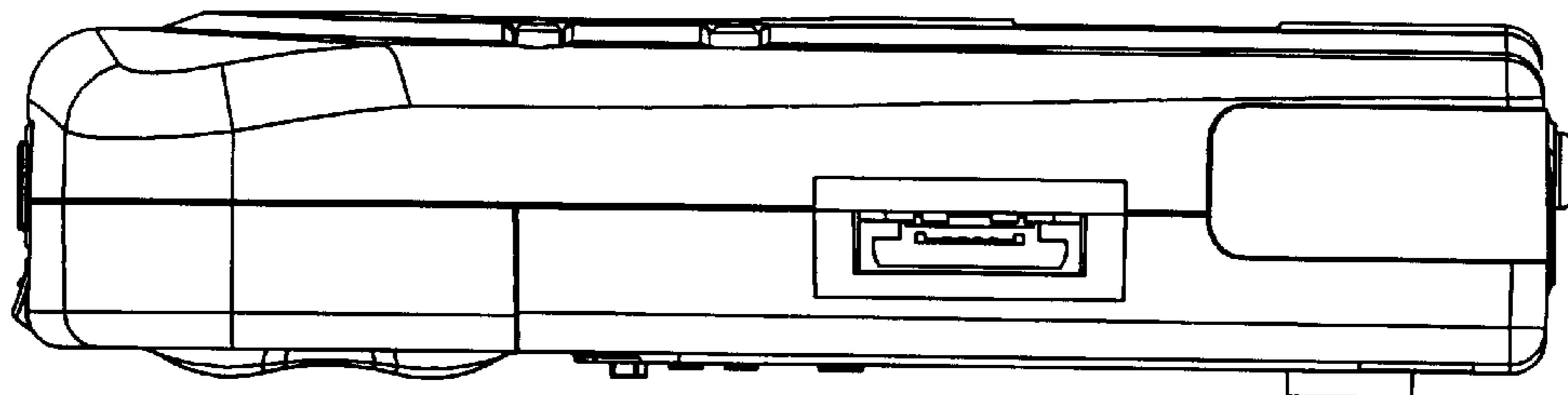

Fig. 5

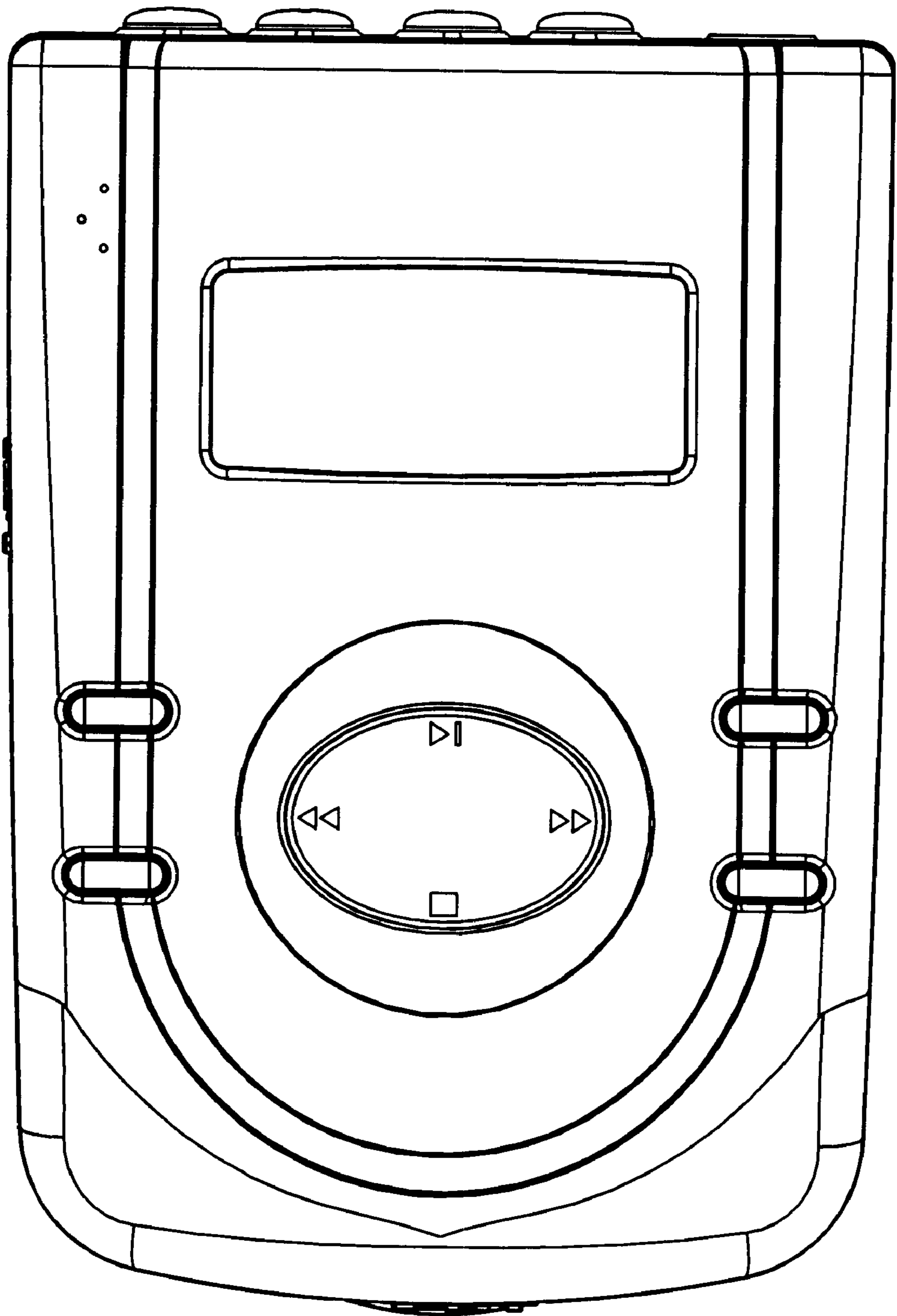

Fig. 6

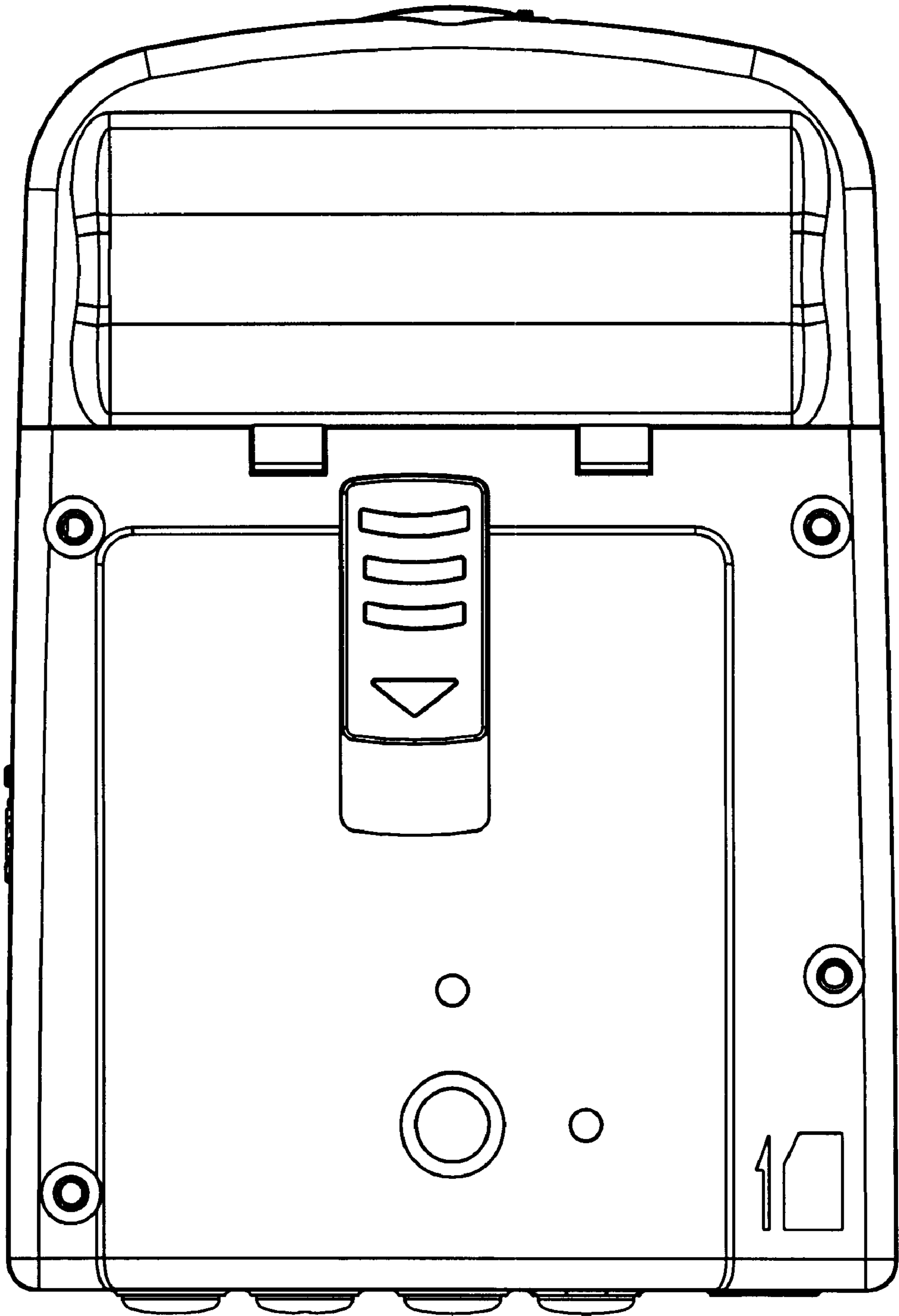

Fig. 7