



US00D452116B1

(12) **United States Design Patent**
McDonough et al.

(10) **Patent No.: US D452,116 S**
(45) **Date of Patent: ** Dec. 18, 2001**

(54) **TRAINER CUP**

(76) Inventors: **Justin E. McDonough**, 12 Ballentine St., Kenvil, NJ (US) 07847; **Steve Aridgides**, 327 Michael Rd., Yardley, PA (US) 19067

(**) Term: **14 Years**

(21) Appl. No.: **29/143,057**

(22) Filed: **Jun. 6, 2001**

Related U.S. Application Data

(60) Division of application No. 29/124,904, filed on Jun. 12, 2000, which is a continuation-in-part of application No. 29/116,372, filed on Dec. 30, 1999.

(51) **LOC (7) Cl. 07-01**

(52) **U.S. Cl. D7/510; D7/511**

(58) **Field of Search D7/509, 507, 510, D7/511, 514, 515, 532, 608, 536, 538, 606, 300.1, 523; D9/538; 220/729, 23.86, 715, 713, 674; 229/402; 206/520**

(56) **References Cited**

U.S. PATENT DOCUMENTS

4,138 8/1845 Pratt .

(List continued on next page.)

FOREIGN PATENT DOCUMENTS

88059 1/1984 (AU) .

(List continued on next page.)

OTHER PUBLICATIONS

Excerpt from publication by Herrmann, Bernd, Institute of Anthropology, Gottingen University, May 1990.

(List continued on next page.)

Primary Examiner—M. N. Pandozzi

(57) **CLAIM**

The ornamental design for a trainer cup, as shown.

DESCRIPTION

FIG. 1 is a perspective view of a first embodiment of a trainer cup showing our new design;

FIG. 2 is a front elevational view of the first embodiment; FIG. 3 is a rear elevational view of the first embodiment; FIG. 4 is a right side elevational view of the first embodiment; FIG. 5 is a left side elevational view of the first embodiment; FIG. 6 is a top plan view of the first embodiment; FIG. 7 is a bottom plan view of the first embodiment; FIG. 8 is a perspective view of a second embodiment of a trainer cup, having a different cap from the first embodiment; FIG. 9 is a front elevational view of the second embodiment; FIG. 10 is a rear elevational view of the second embodiment; FIG. 11 is a right side elevational view of the second embodiment; FIG. 12 is a left side elevational view of the second embodiment; FIG. 13 is a top plan view of the second embodiment; FIG. 14 is a bottom plan view of the second embodiment; FIG. 15 is a perspective view of a third embodiment of a trainer cup, having a body with feet and the same cap as the first embodiment; FIG. 16 is a front elevational view of the third embodiment; FIG. 17 is a rear elevational view of the third embodiment; FIG. 18 is a right side elevational view of the third embodiment; FIG. 19 is a left side elevational view of the third embodiment; FIG. 20 is a top view of the third embodiment; FIG. 21 is a bottom plan view of the third embodiment; FIG. 22 is a perspective view of a fourth embodiment of a trainer cup, having a body with feet and the same cap as the second embodiment; FIG. 23 is a front elevational view of the fourth embodiment; FIG. 24 is a rear elevational view of the fourth embodiment; FIG. 25 is a right side elevational view of the fourth embodiment; FIG. 26 is a left side elevational view of the fourth embodiment; FIG. 27 is a top plan view of the fourth embodiment; and, FIG. 28 is a bottom plan view of the fourth embodiment.

1 Claim, 16 Drawing Sheets

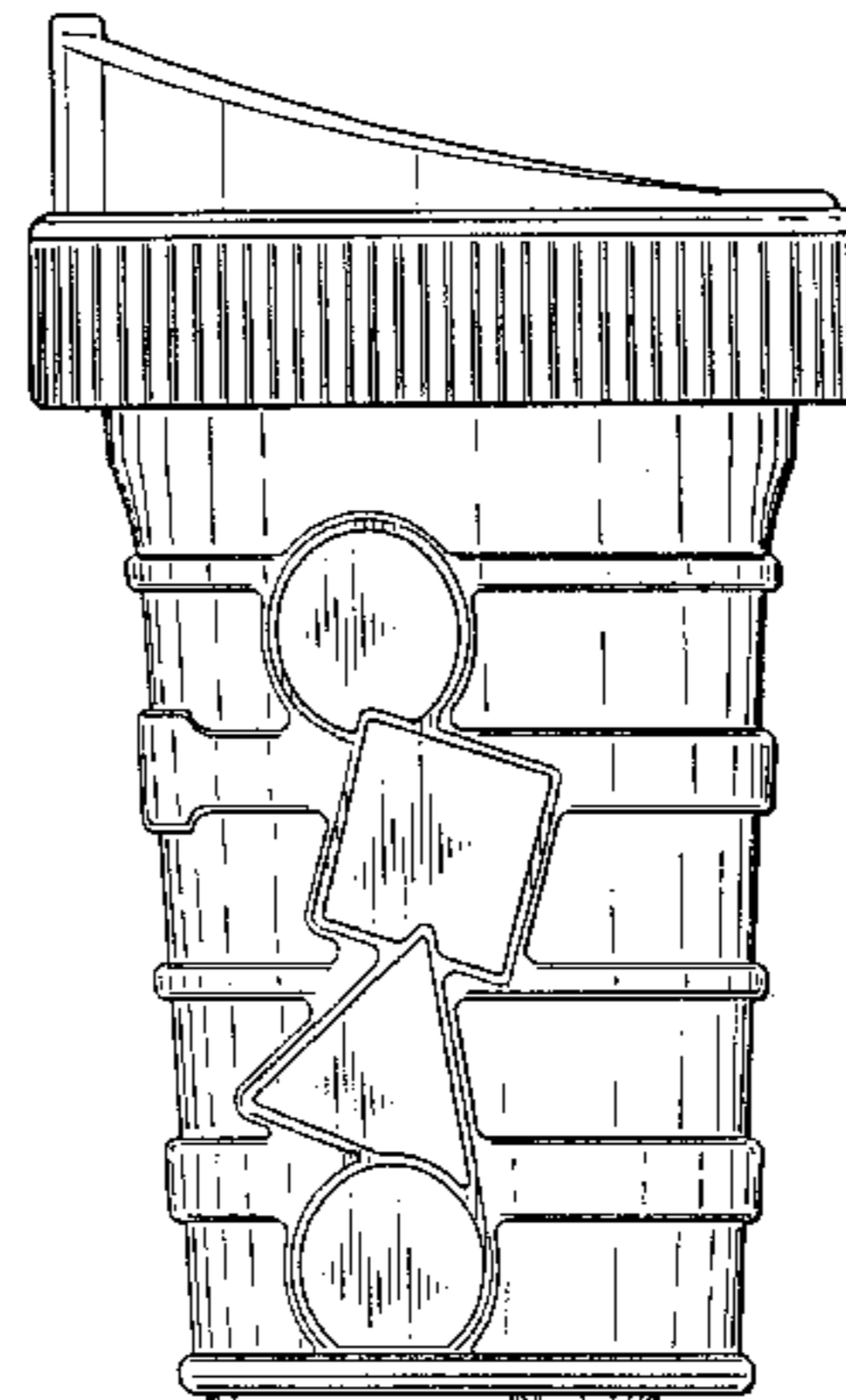
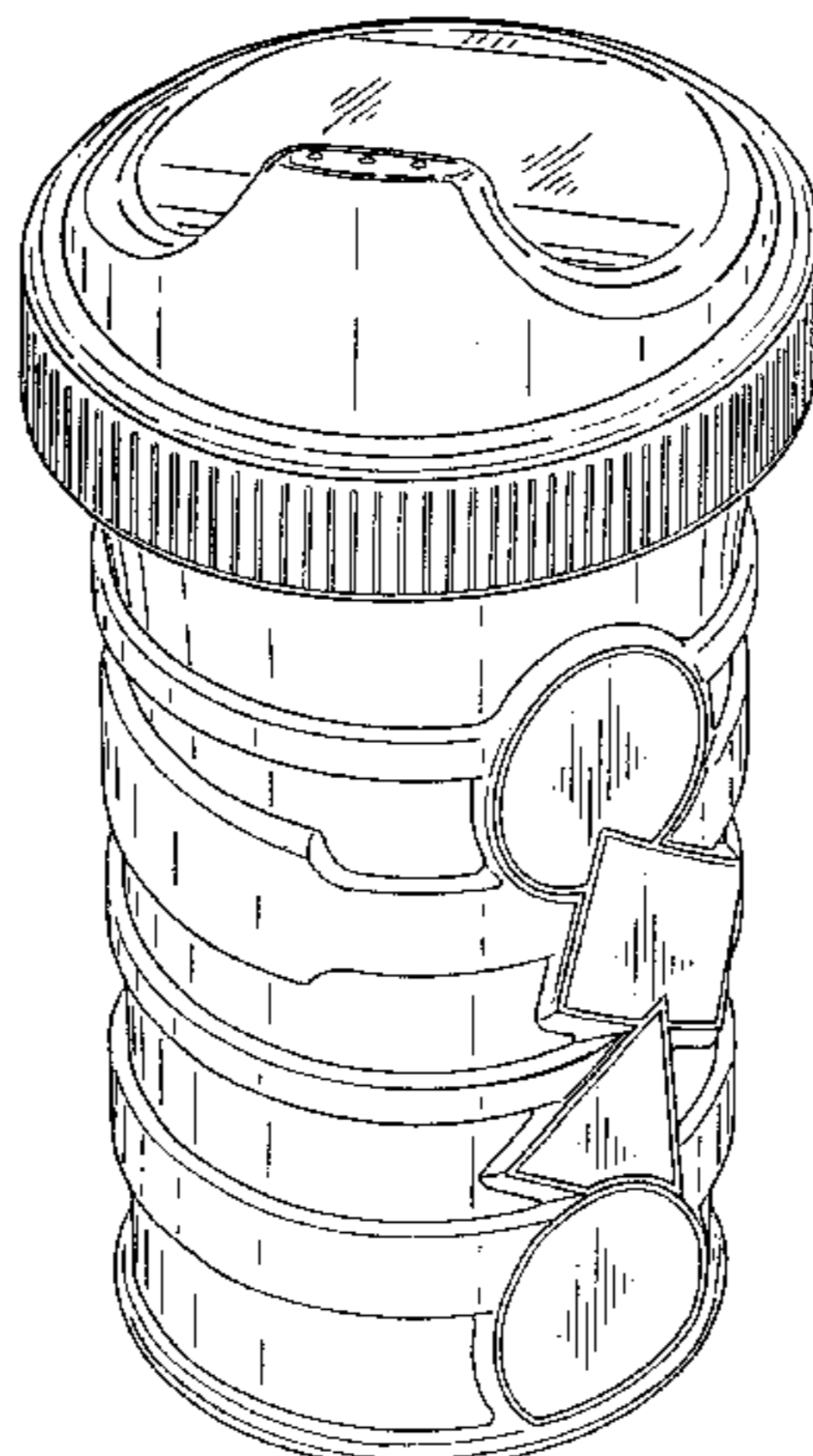

US D452,116 S

Page 2

U.S. PATENT DOCUMENTS					
			4,450,977	5/1984	Colburn et al. .
			4,463,859	8/1984	Greene .
			4,524,805	6/1985	Hoffman .
			4,600,111	7/1986	Brown .
			4,616,768	10/1986	Flier .
			4,660,747	4/1987	Borg et al. .
			4,693,410	9/1987	Selz .
			4,723,668	2/1988	Cheng .
			4,728,006	3/1988	Drobish et al. .
			4,749,108	6/1988	Dornbusch et al. .
			4,768,674	9/1988	Prescott .
			4,782,975	11/1988	Coy .
			4,909,416	3/1990	Evezich .
			4,946,062	8/1990	Coy .
			5,005,737	4/1991	Rohr .
			5,033,655	7/1991	Brown .
			5,035,340	7/1991	Timmons .
			5,040,756	8/1991	Via Cava .
			5,071,017	12/1991	Stull .
			5,079,013	1/1992	Belanger .
			5,096,082	3/1992	Hoefler .
			5,117,999	6/1992	Canzano et al. .
			5,147,066	9/1992	Snider .
			5,186,347	2/1993	Freeman et al. .
			5,213,236	5/1993	Brown et al. .
			5,222,623	6/1993	Eger et al. .
			5,261,459	11/1993	Atkinson et al. .
			5,339,995	8/1994	Brown et al. .
			5,363,983	11/1994	Proshan .
			5,370,258	12/1994	Fair .
			5,377,877	1/1995	Brown et al. .
			5,402,836	4/1995	Hasper et al. .
			5,409,144	4/1995	Brown .
			5,439,143	8/1995	Brown et al. .
			5,531,363	7/1996	Gross et al. .
			5,542,670	8/1996	Morano .
			5,626,262	5/1997	Fitten et al. .
			5,632,420	5/1997	Lohrman et al. .
			5,655,687	8/1997	Fitten et al. .
			5,676,289	10/1997	Gross et al. .
			5,680,969	10/1997	Gross .
			5,706,973	1/1998	Robbins, III et al. .
			5,758,790	6/1998	Ewing, Jr. .
			5,833,115	11/1998	Eiten .
			5,839,581	11/1998	Vagedes .
			5,839,614	11/1998	Brown .
			5,839,626	11/1998	Gross et al. .
			5,862,927	1/1999	Tebeau .
			5,871,118	2/1999	Franzese .
			5,890,619	4/1999	Belanger .
			5,890,620	4/1999	Belcastro .
			5,890,621	4/1999	Bachman et al. .
			5,893,472	4/1999	Forrer .
			5,894,952	4/1999	Mendenhall et al. .
			5,897,033	4/1999	Okawa et al. .
			5,904,275	5/1999	Suffa .
			5,924,605	7/1999	Baudin et al. .
			5,927,566	7/1999	Mueller .
			5,927,567	7/1999	Fillmore .
			5,934,512	8/1999	Lampe et al. .
			5,934,514	8/1999	Lampe et al. .
			5,938,086	8/1999	Gross .
			5,944,234	8/1999	Lampe et al. .
			5,950,857	9/1999	Rosen .
			5,954,237	9/1999	Lampe et al. .
			5,971,232	10/1999	Rohr et al. .
			5,975,354	11/1999	Goncalves .
Re. 30,805	11/1981	Rhoads .			
D. 239,358	3/1976	Kjellquist .			
D. 240,287	6/1976	Sepaneva et al. .			
D. 247,840	5/1978	Dixson .			
D. 346,932	* 5/1994	Cautereels et al.	D7/507		
D. 350,875	9/1994	VanValkenburg et al. .			
D. 362,156	* 9/1995	Goto et al.	D7/511		
D. 371,936	* 7/1996	Goto et al.	D7/523		
D. 374,147	* 10/1996	Lillelund et al.	D7/300.1		
D. 387,619	12/1997	Gross et al. .			
D. 395,202	* 6/1998	Ochs, Sr.	D7/606		
D. 398,813	9/1998	Franzese .			
D. 401,508	* 11/1998	Brown, III	D9/538		
D. 401,808	* 12/1998	Grivsky	D7/536		
D. 404,613	* 1/1999	Hatsumoto et al.	D7/510		
D. 407,269	* 3/1999	Fletcher	D7/510		
D. 408,220	* 4/1999	Chomik	D7/510		
D. 408,689	* 4/1999	Kato	D7/608		
D. 410,174	* 5/1999	Sheu	D7/510		
D. 412,085	7/1999	Roush et al. .			
D. 413,067	8/1999	Haley .			
D. 414,655	* 10/1999	Schwarz	D7/514		
D. 415,429	10/1999	Rausch .			
D. 415,654	10/1999	Forrer .			
D. 416,757	* 11/1999	Ginuntoli	D7/523		
D. 417,590	* 12/1999	Kato	D7/510		
D. 417,591	* 12/1999	Roehrig	D7/510		
D. 417,821	* 12/1999	Cautereels	D7/532		
D. 421,877	* 3/2000	La Torre et al.	D7/510		
D. 421,878	* 3/2000	Roehrig	D7/510		
D. 422,179	* 4/2000	Stephenson	D7/510		
D. 427,017	* 6/2000	Reimer	D7/516		
D. 428,306	* 7/2000	Lee	D7/510		
D. 431,159	9/2000	Otake .			
D. 431,160	9/2000	Stadtler, II .			
D. 434,273	11/2000	Johansen et al. .			
1,206,661	11/1916	Booth .			
1,825,553	9/1931	Smith .			
2,175,052	10/1939	Bull et al. .			
2,223,179	11/1940	Lougheed .			
2,328,382	8/1943	Langdon .			
2,758,755	8/1956	Schaffler .			
2,816,548	12/1957	Tupper .			
3,139,064	6/1964	Harle .			
3,360,169	12/1967	Susuki et al. .			
3,438,527	4/1969	Gamblin, Jr. .			
3,504,699	4/1970	Grisé .			
3,517,682	6/1970	Smith .			
3,635,380	1/1972	Fitzgerald .			
3,650,271	3/1972	Pelli .			
3,674,183	7/1972	Venable et al. .			
3,718,140	2/1973	Yamauchi .			
3,773,233	11/1973	Souza .			
3,825,157	7/1974	Herzig .			
3,860,162	1/1975	Schutz .			
3,905,512	9/1975	Albert et al. .			
3,915,331	10/1975	Chenault .			
3,924,767	12/1975	Arrandale et al. .			
4,002,168	1/1977	Petterson .			
4,133,457	1/1979	Klassen .			
4,184,604	1/1980	Amberg et al. .			
4,186,842	2/1980	Albert .			
4,245,752	1/1981	Prueher .			
4,350,260	9/1982	Prueher .			
4,412,629	11/1983	Dart et al. .			
4,441,623	4/1984	Antoniak .			

5,988,425 11/1999 Yehl et al. .
6,050,445 4/2000 Manganiello .

FOREIGN PATENT DOCUMENTS

4068785 10/1985 (AU) .
97711 8/1987 (AU) .
595296 9/1987 (AU) .
98916 12/1987 (AU) .
99599 2/1988 (AU) .
647010 8/1990 (AU) .
655291 12/1992 (AU) .
118128 9/1993 (AU) .
118493 10/1993 (AU) .
118899 11/1993 (AU) .
684061 1/1994 (AU) .
7943694 5/1995 (AU) .
715393 2/1997 (AU) .
6881196 3/1997 (AU) .
9113098 3/1999 (AU) .
1369599 5/1999 (AU) .
2291399 8/1999 (AU) .
2586099 8/1999 (AU) .
138675 10/1999 (AU) .
138676 10/1999 (AU) .
1296600 6/2000 (AU) .
141078 7/2000 (AU) .
141080 7/2000 (AU) .
2454500 9/2000 (AU) .
3424600 9/2000 (AU) .
2128875 12/1972 (DE) .
2538007 3/1976 (DE) .
29714169 11/1997 (DE) .
0152494 8/1985 (EP) .
0160336 11/1985 (EP) .
0278125 8/1988 (EP) .
0326743 8/1989 (EP) .
0382631 8/1990 (EP) .
0384394 8/1990 (EP) .
0442379 8/1991 (EP) .
0495435 7/1992 (EP) .
0495440 7/1992 (EP) .
0545678 6/1993 (EP) .
0555623 8/1993 (EP) .
0591601 4/1994 (EP) .
0634922 1/1995 (EP) .
0723413 7/1996 (EP) .
0838184 4/1998 (EP) .
1364891 5/1964 (FR) .
2624102 6/1989 (FR) .
1253398 11/1971 (GB) .
2015350 9/1979 (GB) .
2029379A 3/1980 (GB) .
2131301A 6/1984 (GB) .
2169210A 7/1986 (GB) .
2169210B 7/1986 (GB) .
2183225A 6/1987 (GB) .
2190073B 11/1987 (GB) .

2226014A 6/1990 (GB) .
2227159A 7/1990 (GB) .
2266045B 10/1993 (GB) .
2279130A 12/1994 (GB) .
2285621A 7/1995 (GB) .
2304545A 3/1997 (GB) .
2304545B 3/1997 (GB) .
2311061A 9/1997 (GB) .
2314497A 1/1998 (GB) .
2314497B 1/1998 (GB) .
2317608A 4/1998 (GB) .
699693 2/1987 (JP) .
699694 2/1987 (JP) .
6996931 3/1987 (JP) .
738127 7/1988 (JP) .
775839 11/1989 (JP) .
880081 10/1993 (JP) .
900603 6/1994 (JP) .
946622 2/1996 (JP) .
946624 2/1996 (JP) .
967767 11/1996 (JP) .
1025434 11/1998 (JP) .
1056829 12/1999 (JP) .
1056837 12/1999 (JP) .
1083150 8/2000 (JP) .
1107210 4/2001 (JP) .
8401143 3/1984 (WO) .
8504086 9/1985 (WO) .
9319718 10/1993 (WO) .
9400363 1/1994 (WO) .
9404023 3/1994 (WO) .
9405552 3/1994 (WO) .
9510965 4/1995 (WO) .
9513220 5/1995 (WO) .
9521097 8/1995 (WO) .
9521098 8/1995 (WO) .
9708979 3/1997 (WO) .
9817157 4/1998 (WO) .
9818427 5/1998 (WO) .
9820832 5/1998 (WO) .
9908578 2/1999 (WO) .
9939617 8/1999 (WO) .

OTHER PUBLICATIONS

Excerpt from *The Bounty BabyCare Guide*, © Bounty Services Ltd, 1991.
Excerpt from *Baby Care Products* 1992, showing Púr products.
Press Release by Maws of Hertford, England, Apr. 1992.
Perfect Ideas from Tommee Tippee, *Chemist & Druggist*, Aug. 15, 1992, p. 264.
New Visions Mealtimes 1998–1999 Catalog, Faber, Virginia.
Púr Catalog, undated.

* cited by examiner

FIG. 1

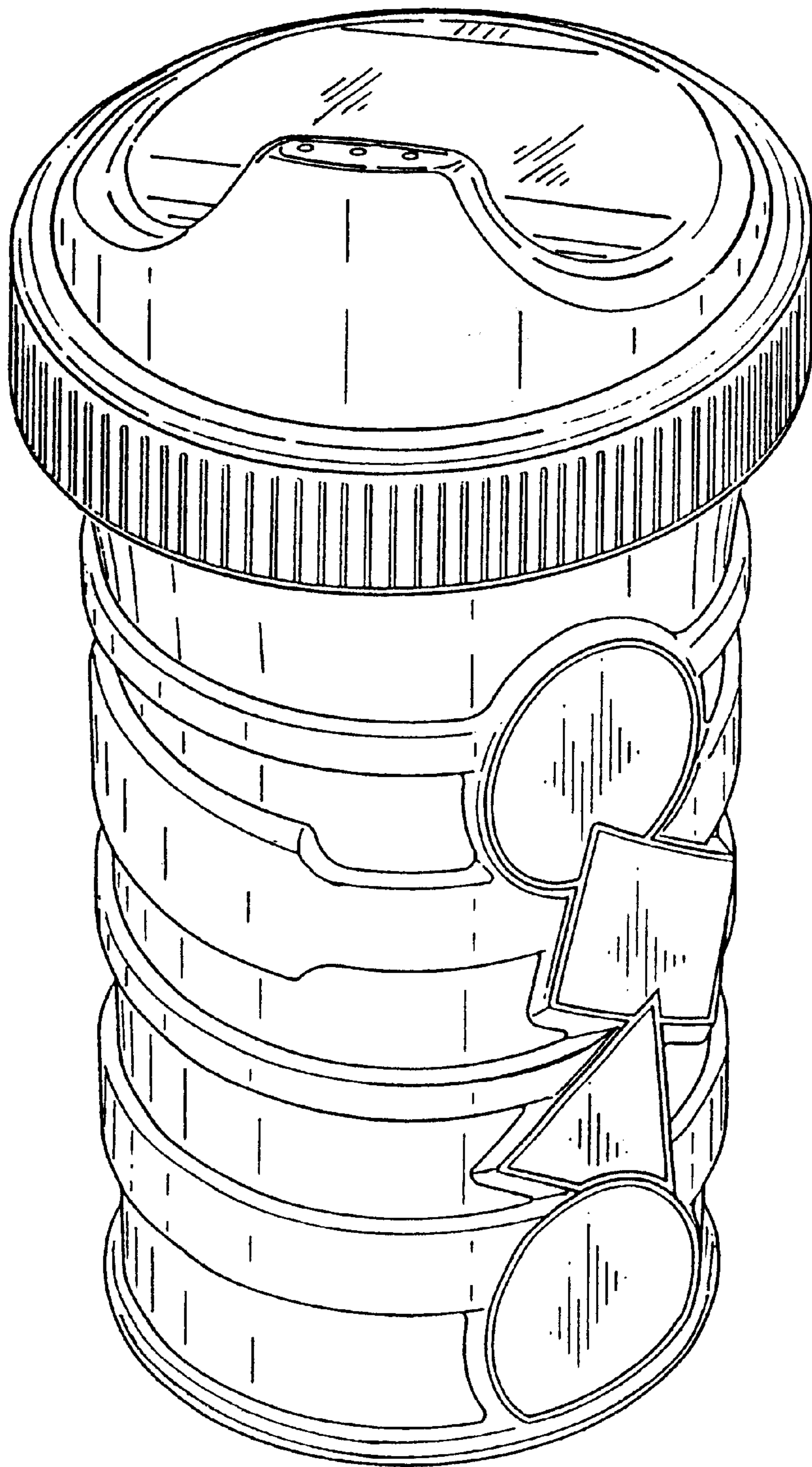

FIG. 3

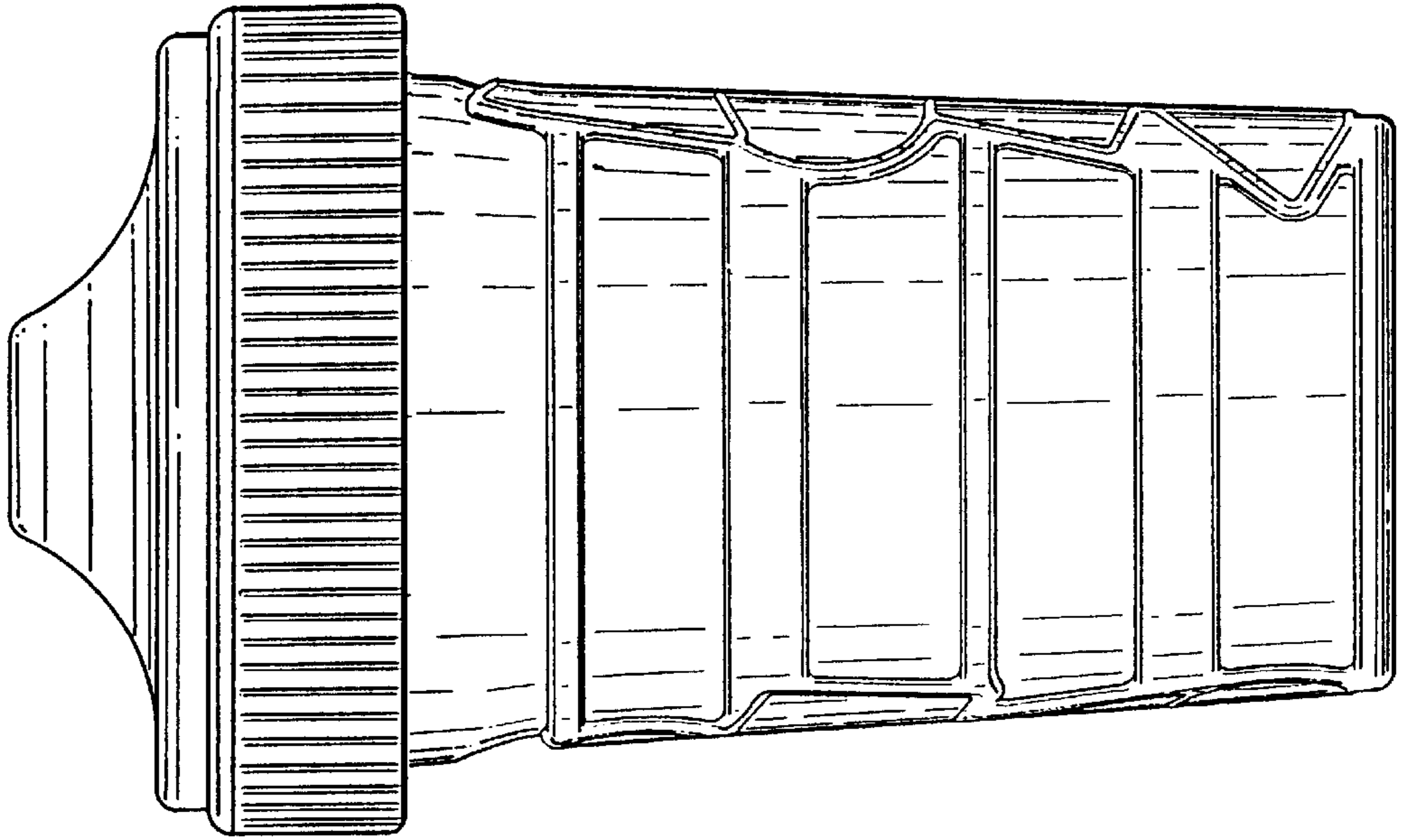

FIG. 2

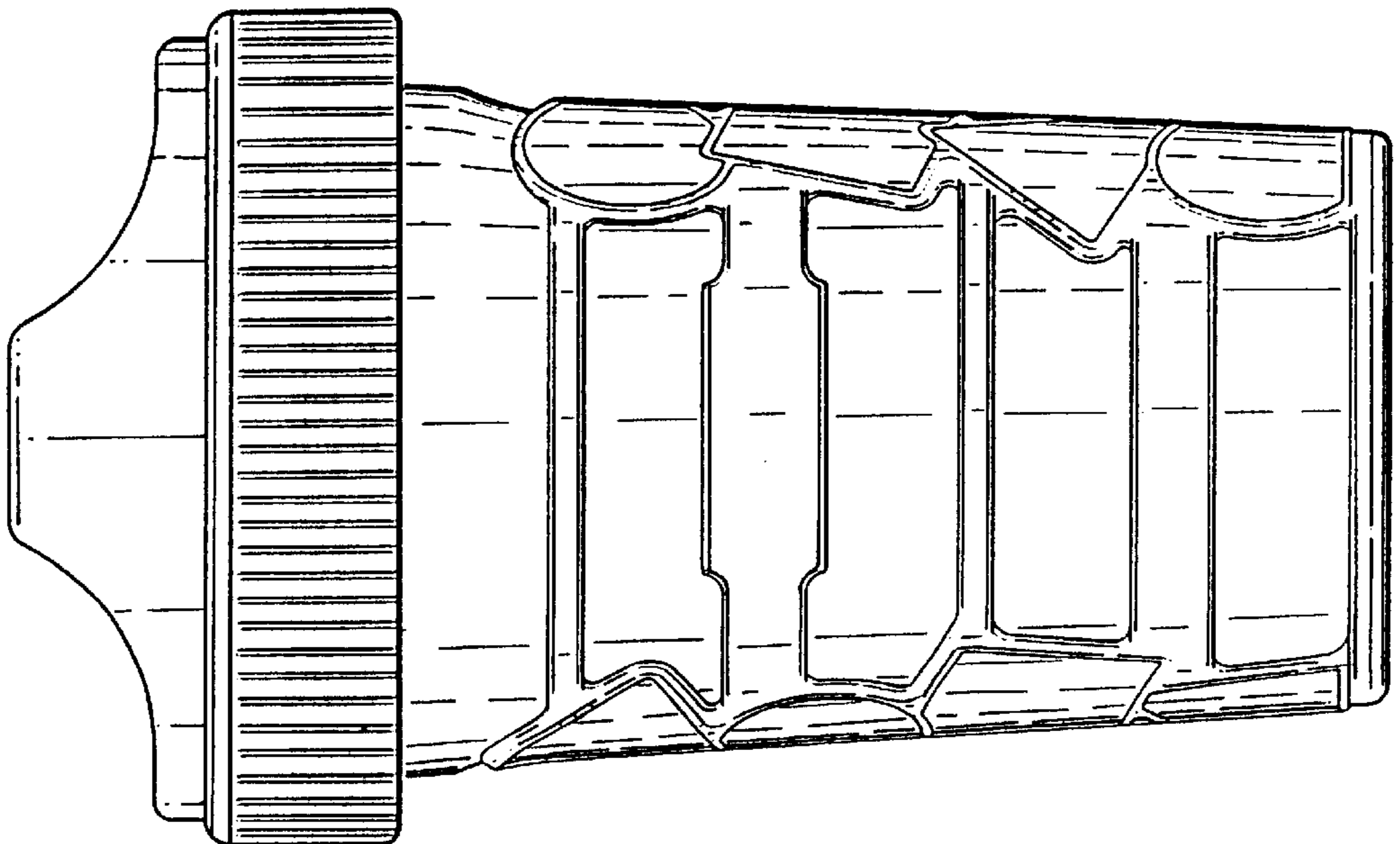

FIG. 5

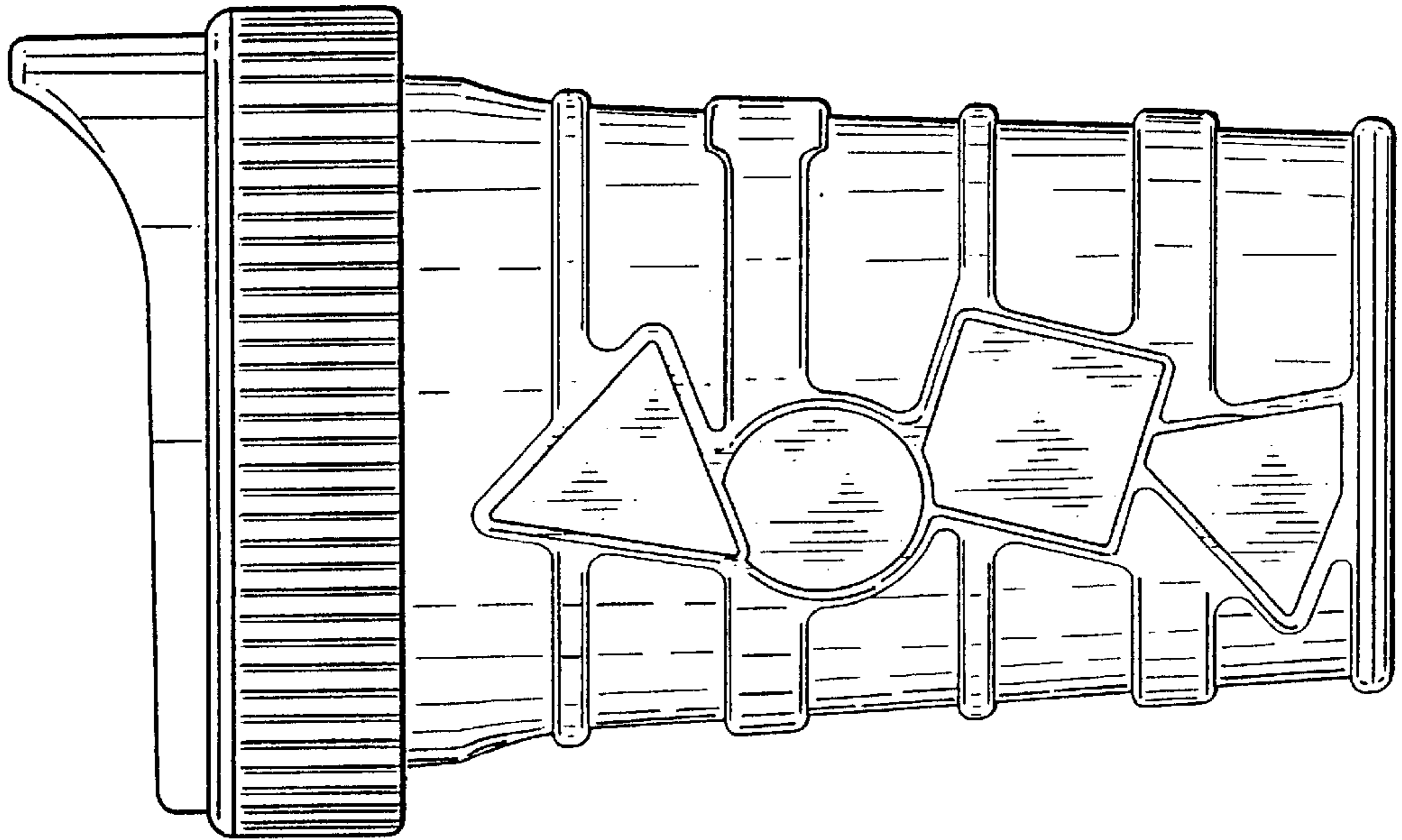

FIG. 4

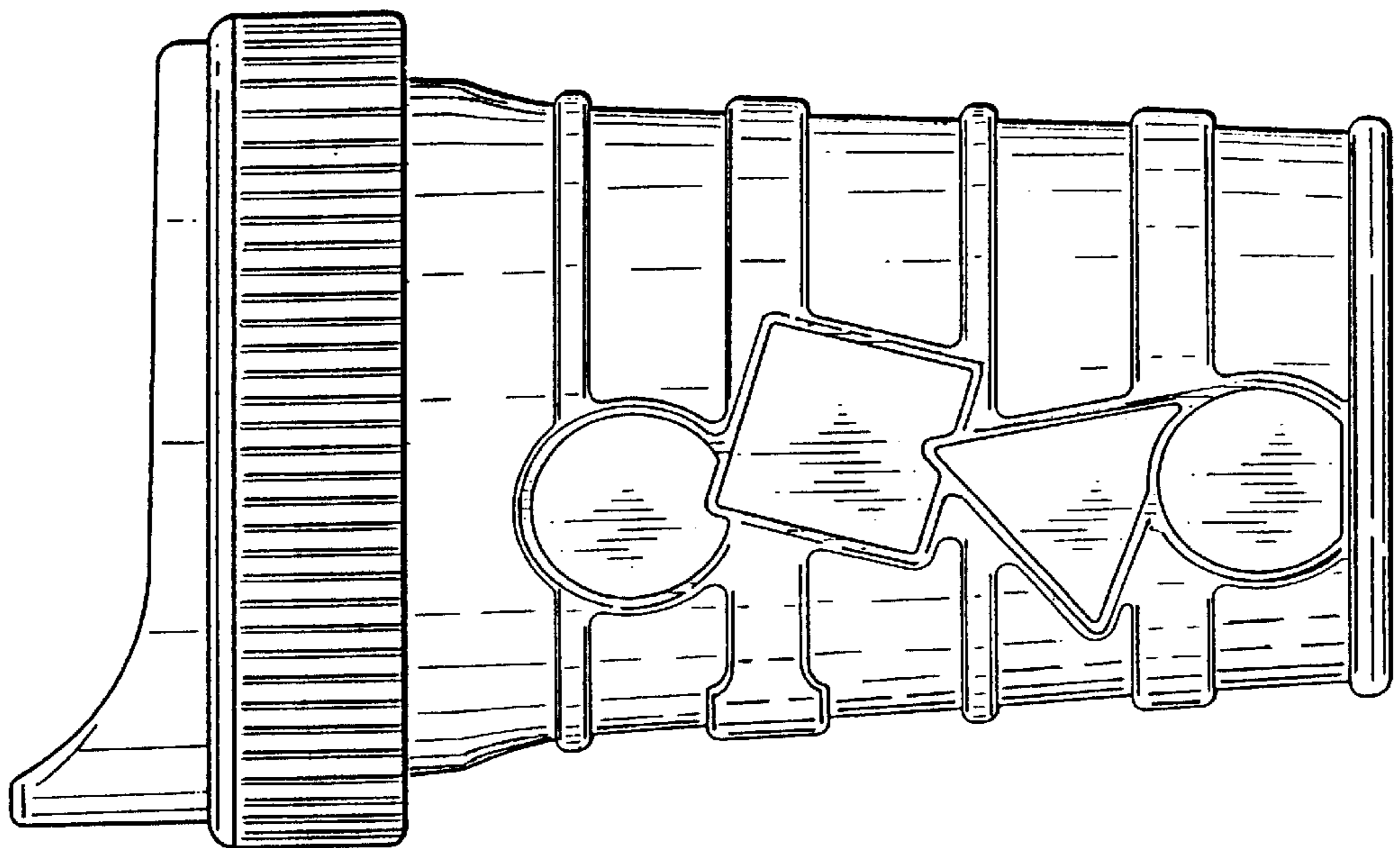

FIG. 6

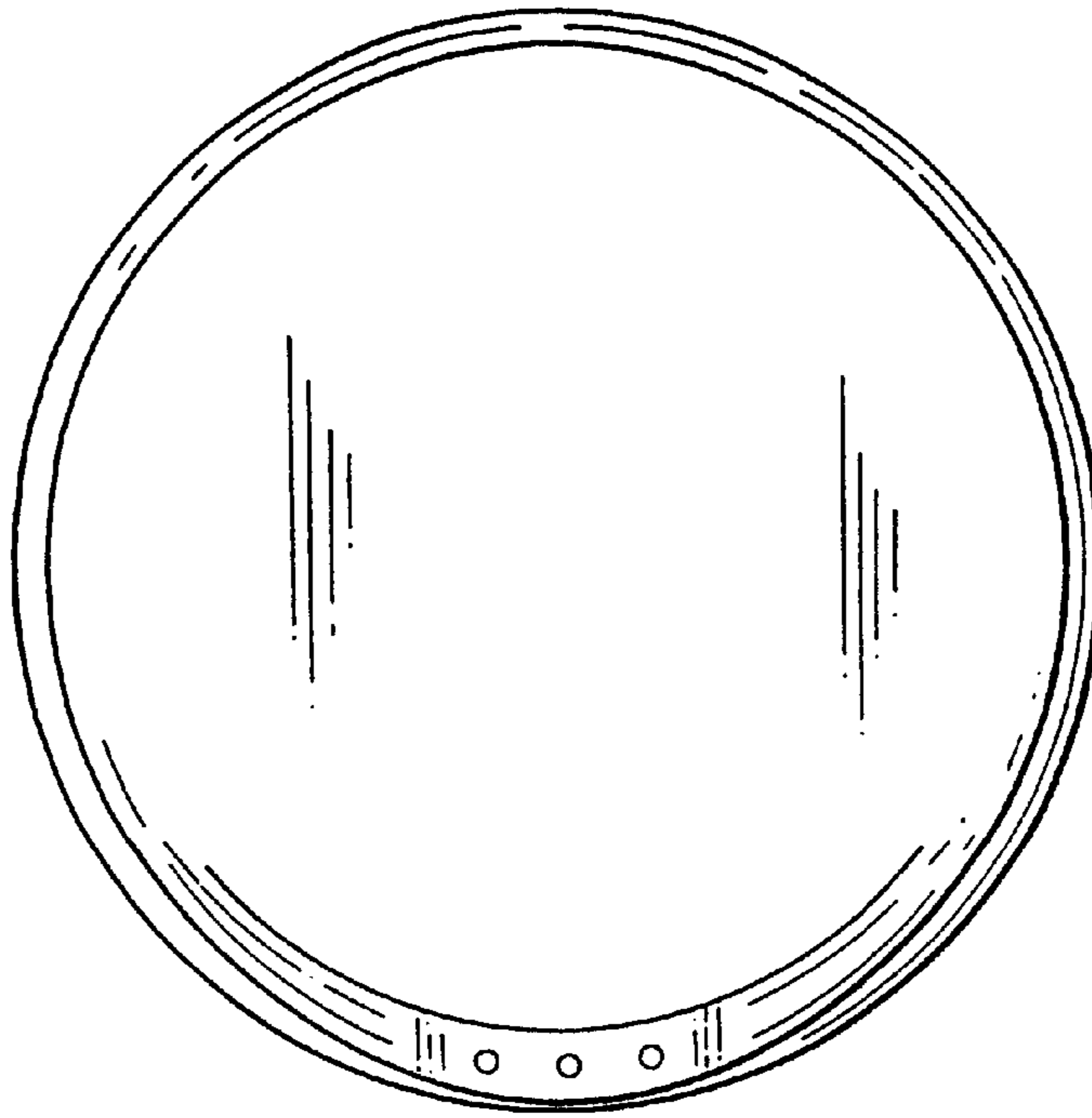

FIG. 7

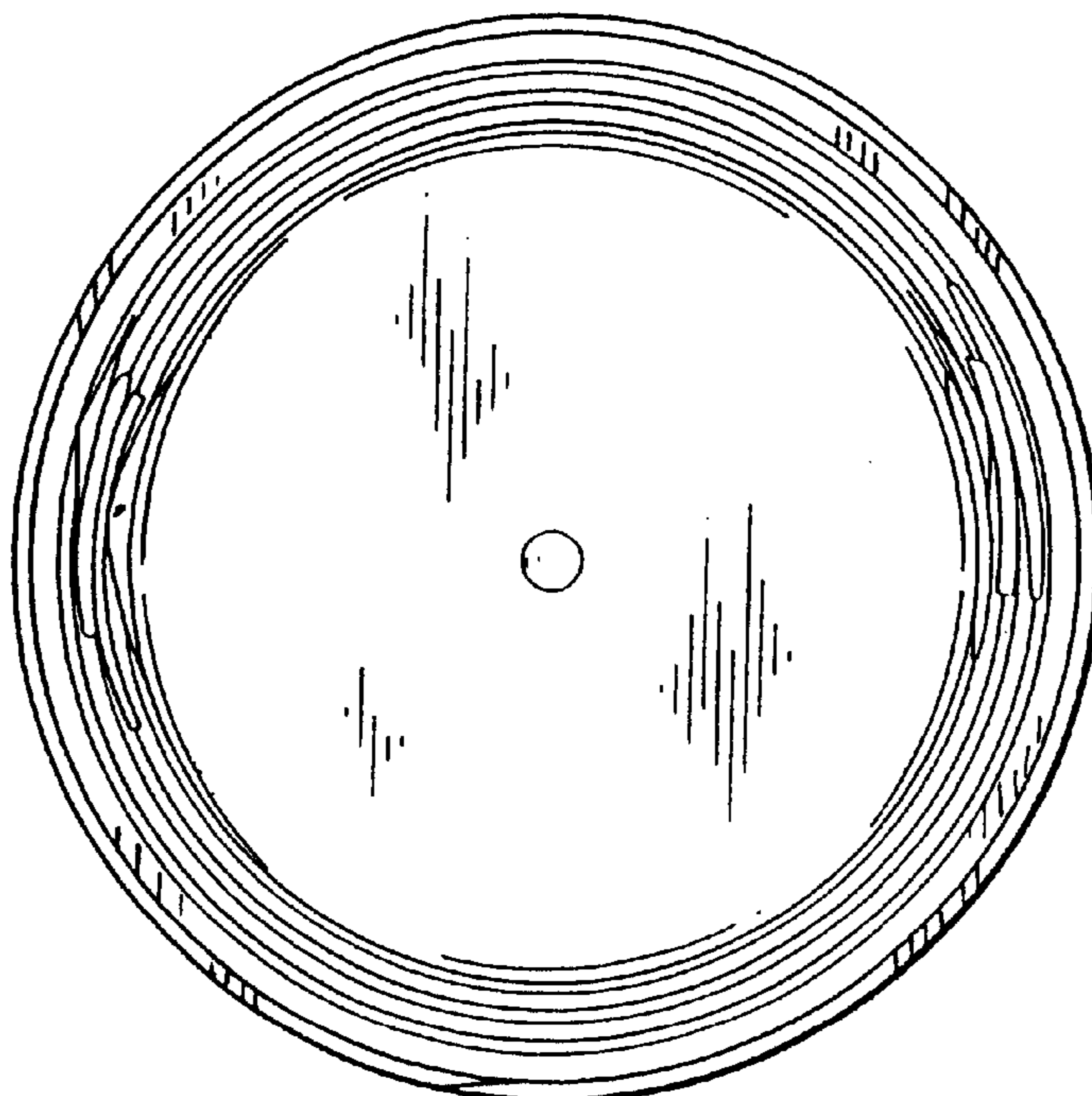

FIG. 8

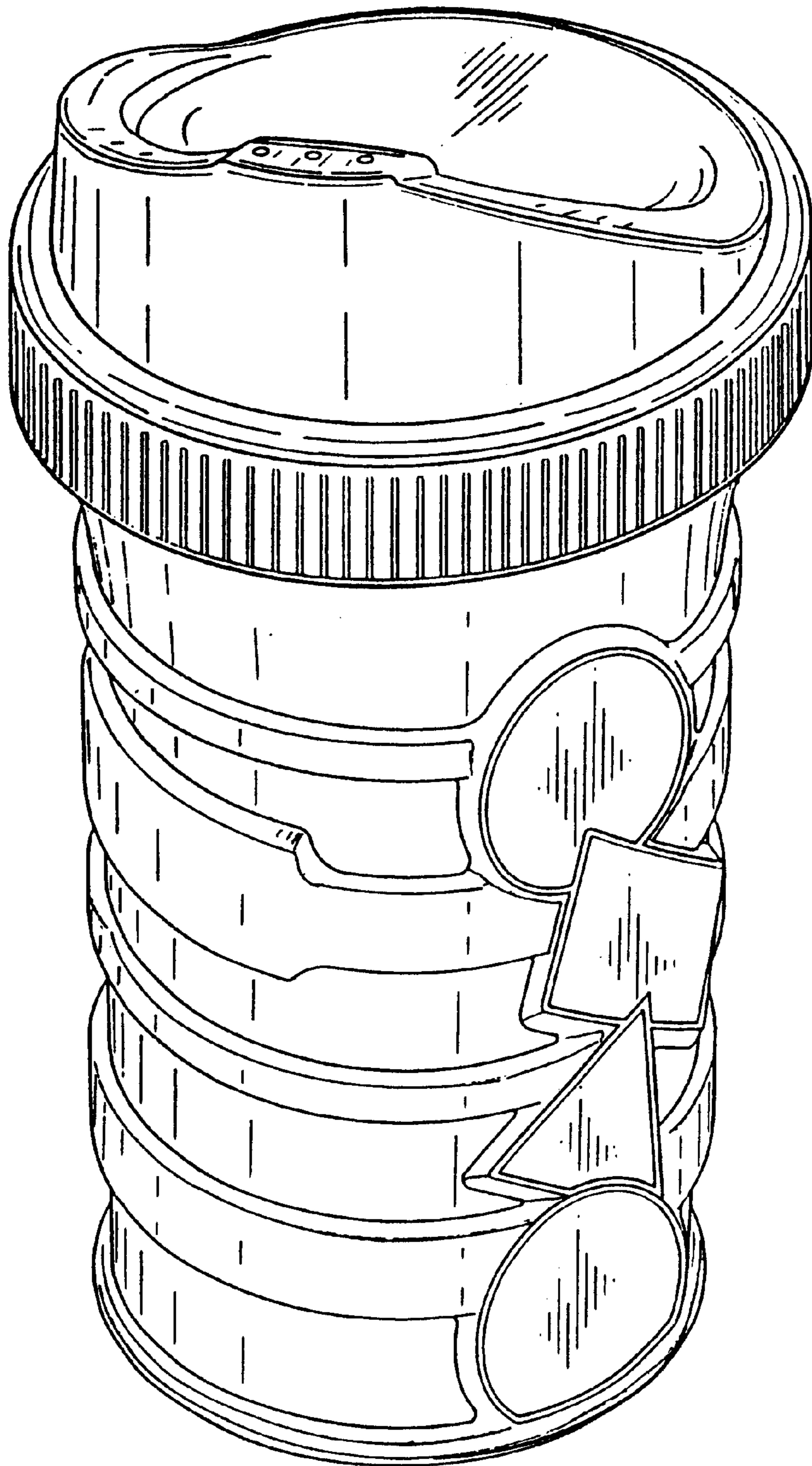

FIG. 10

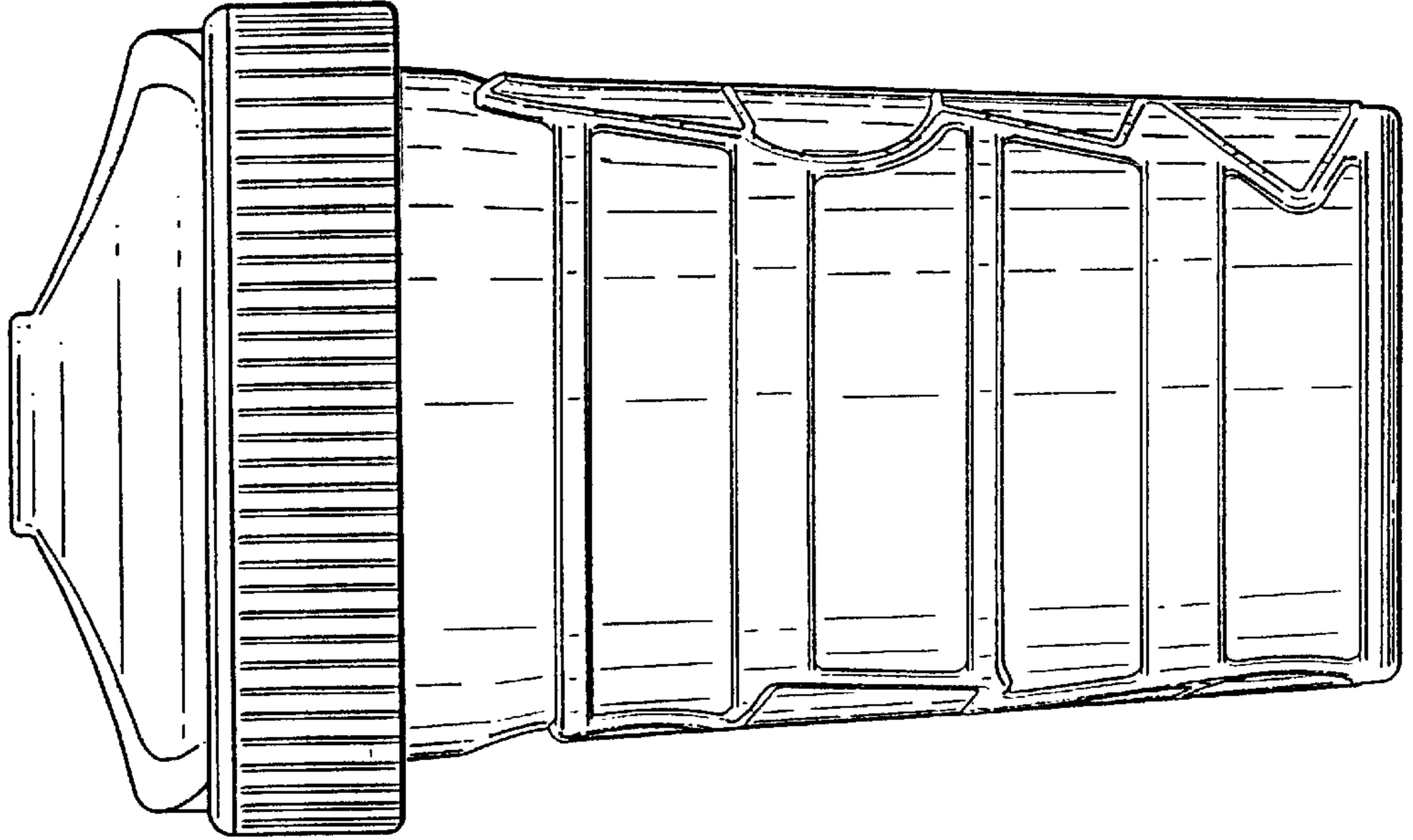

FIG. 9

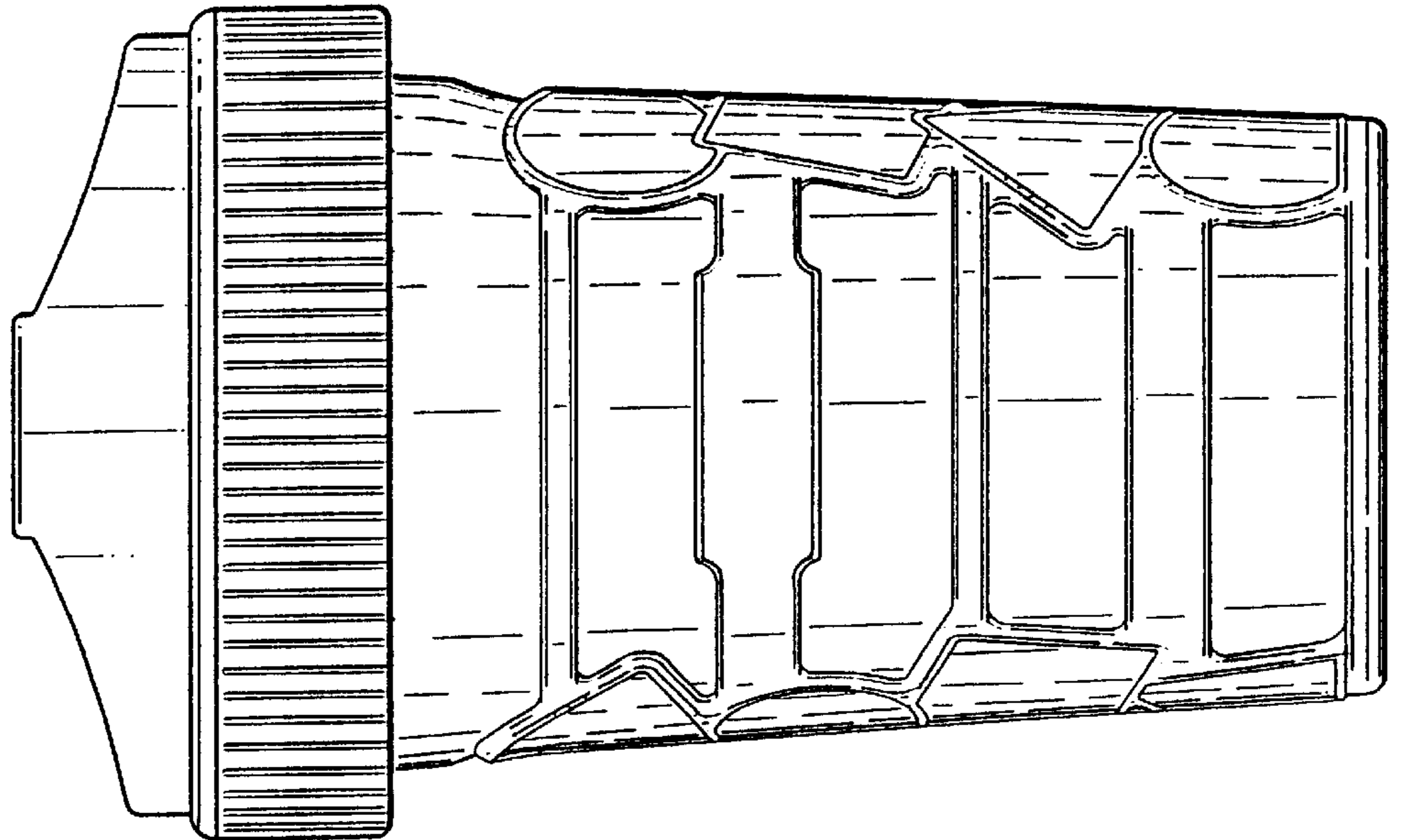

FIG. 12

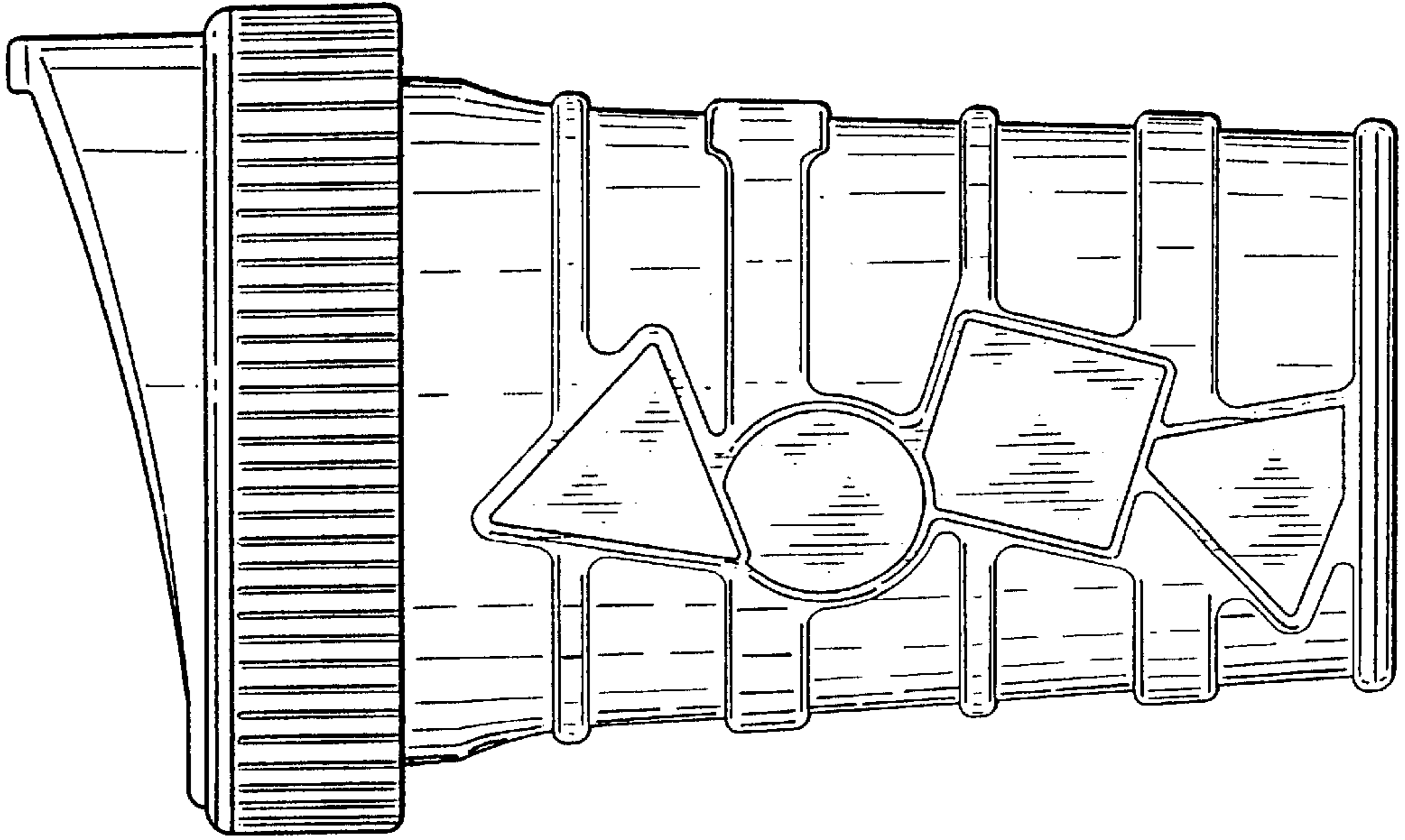

FIG. 11

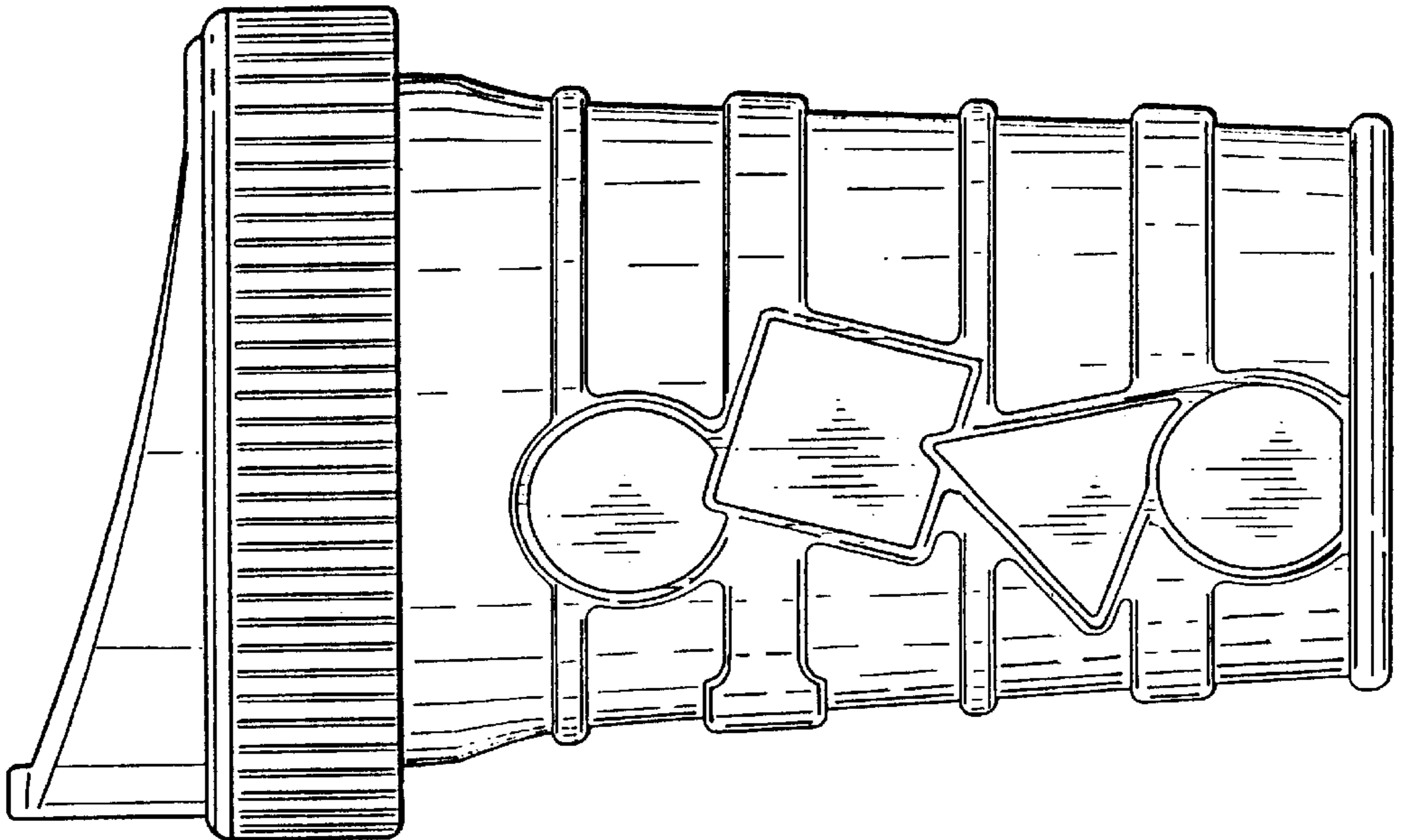

FIG. 13

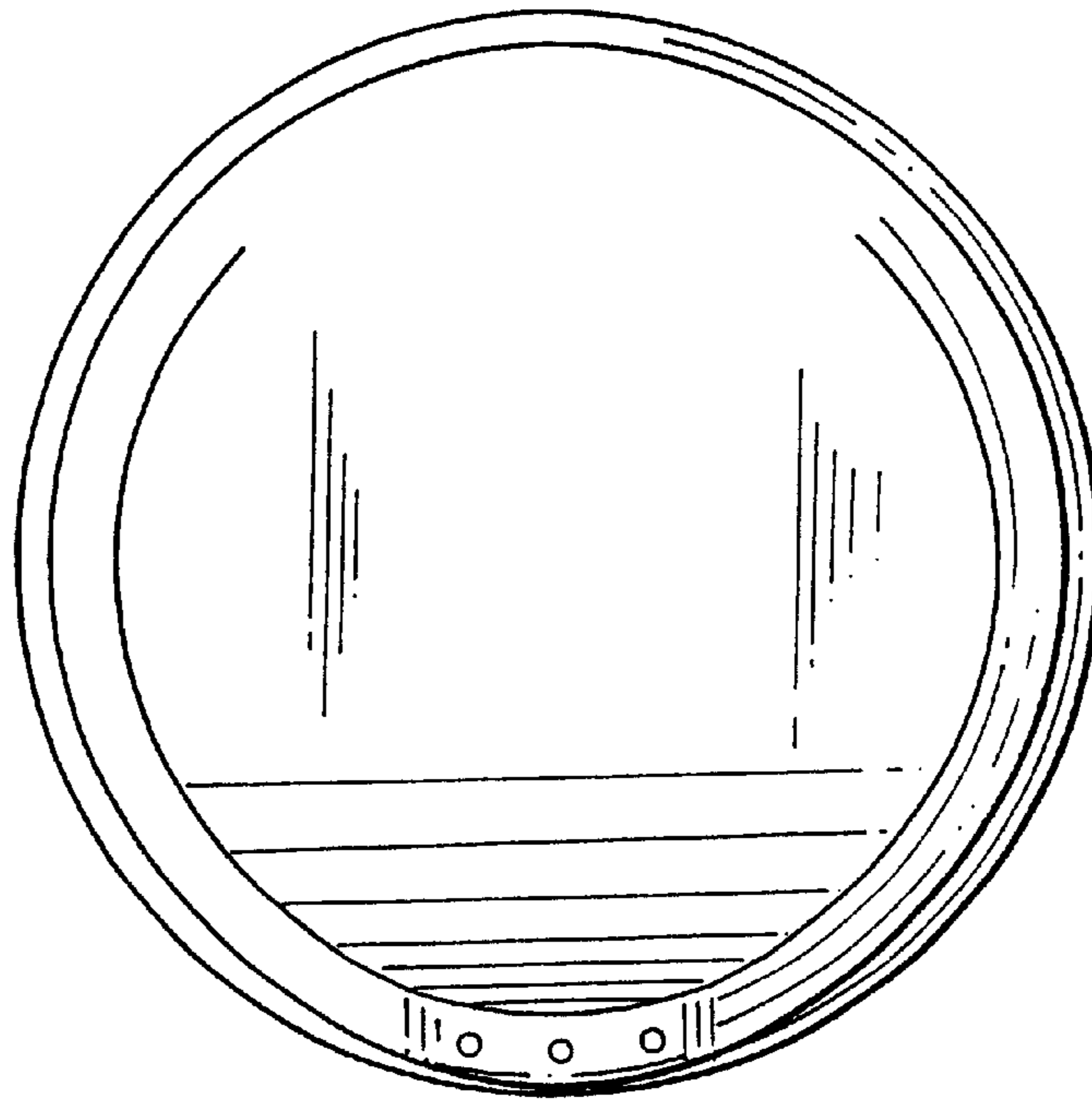

FIG. 14

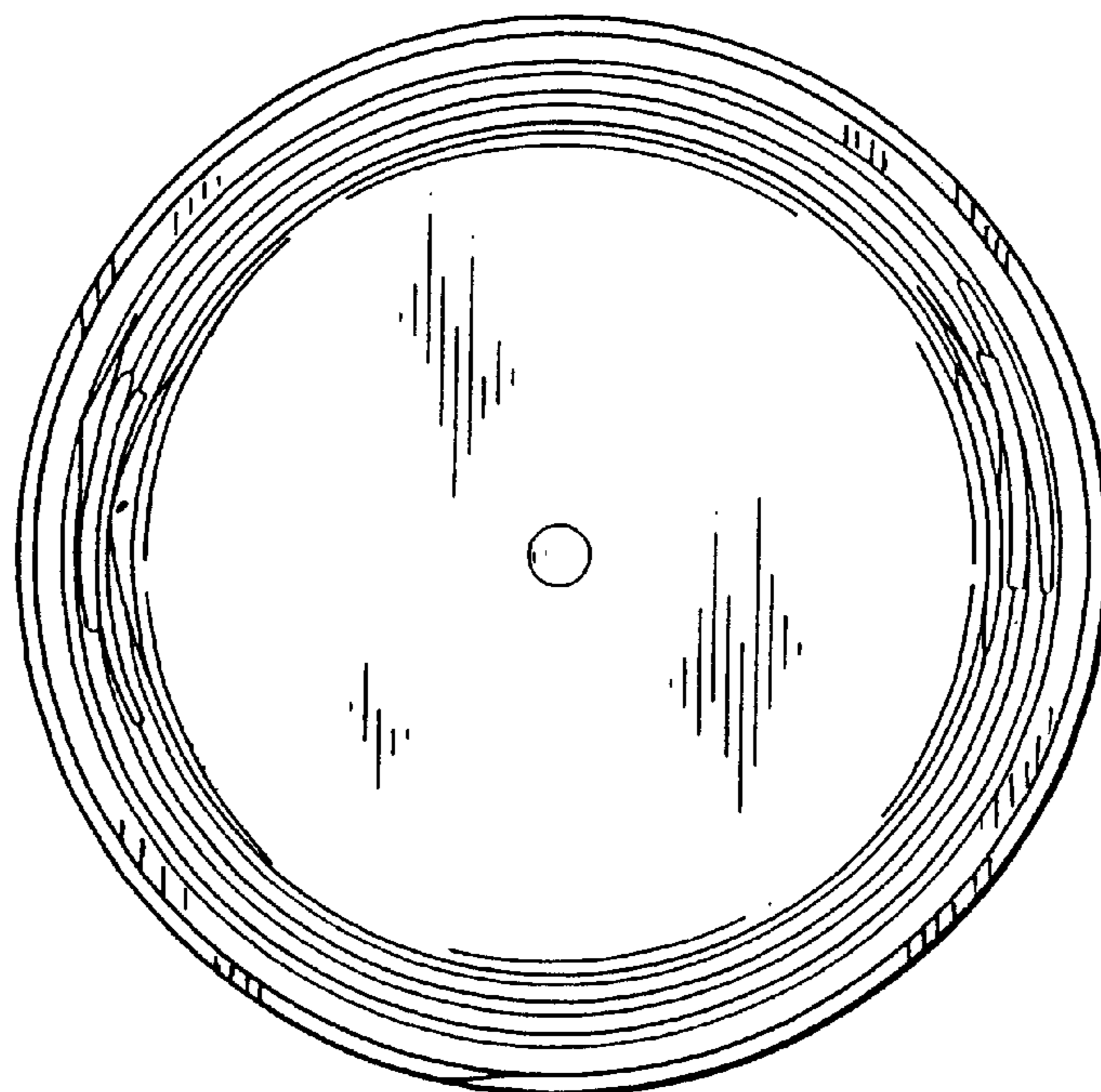

FIG. 15

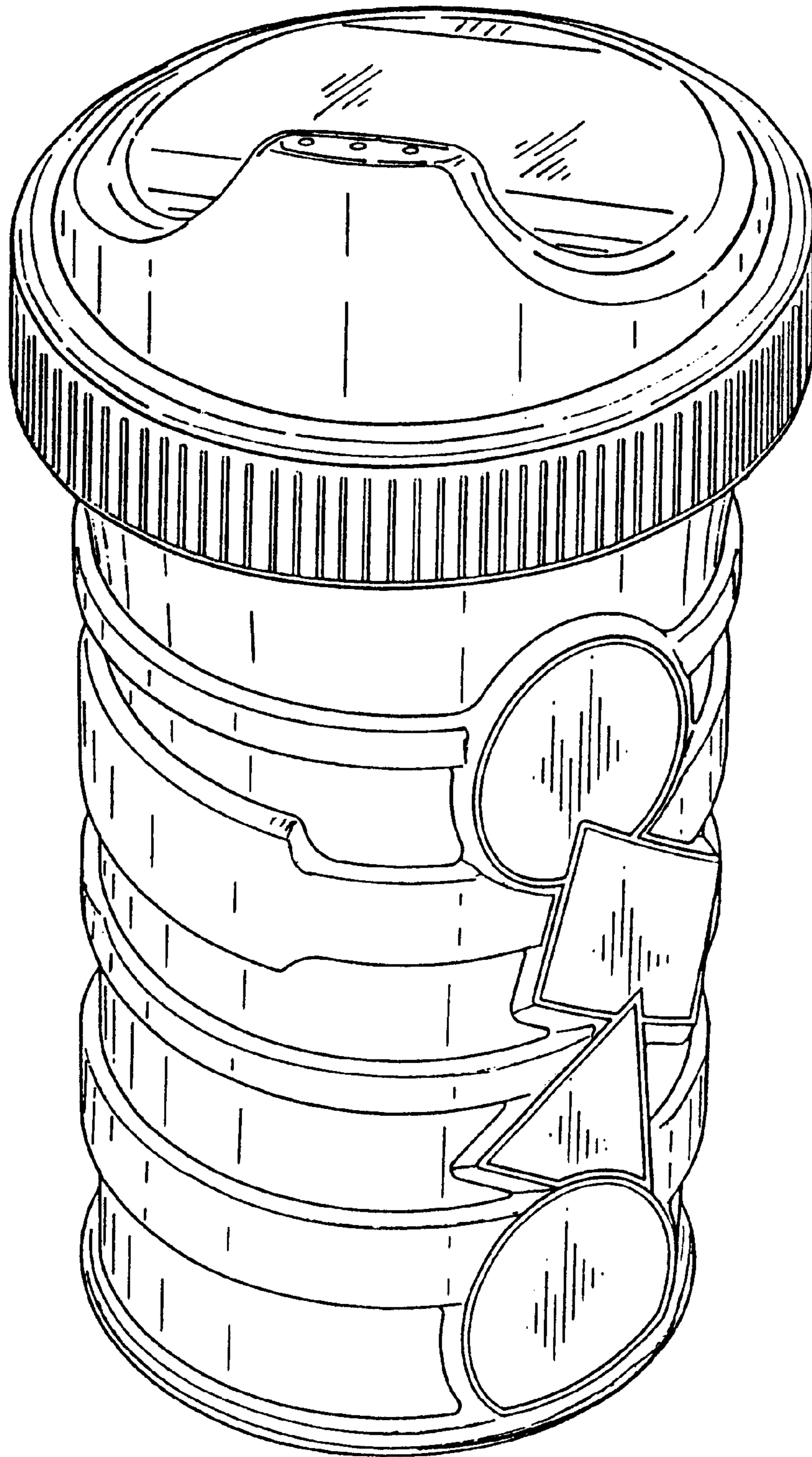

FIG. 17

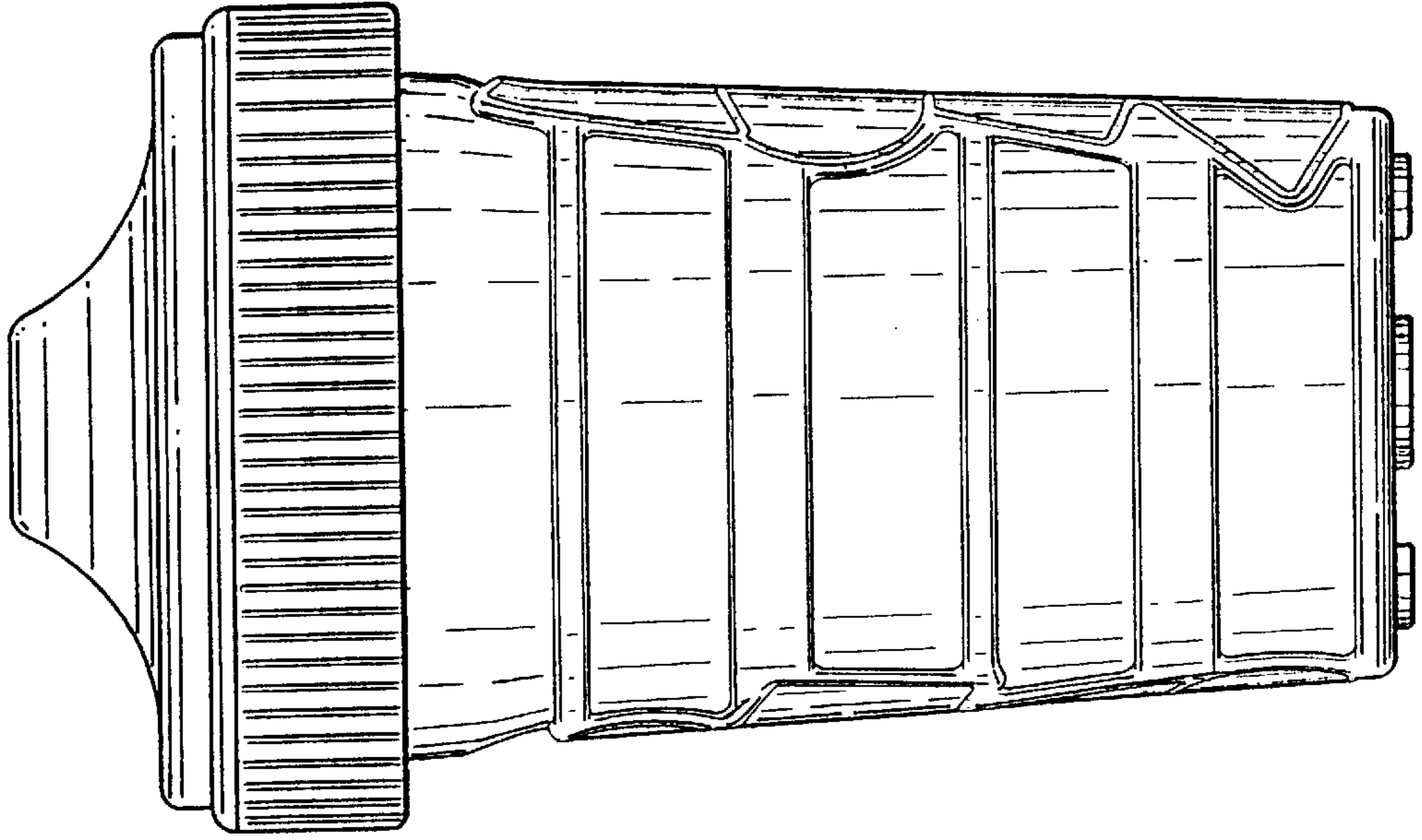

FIG. 16

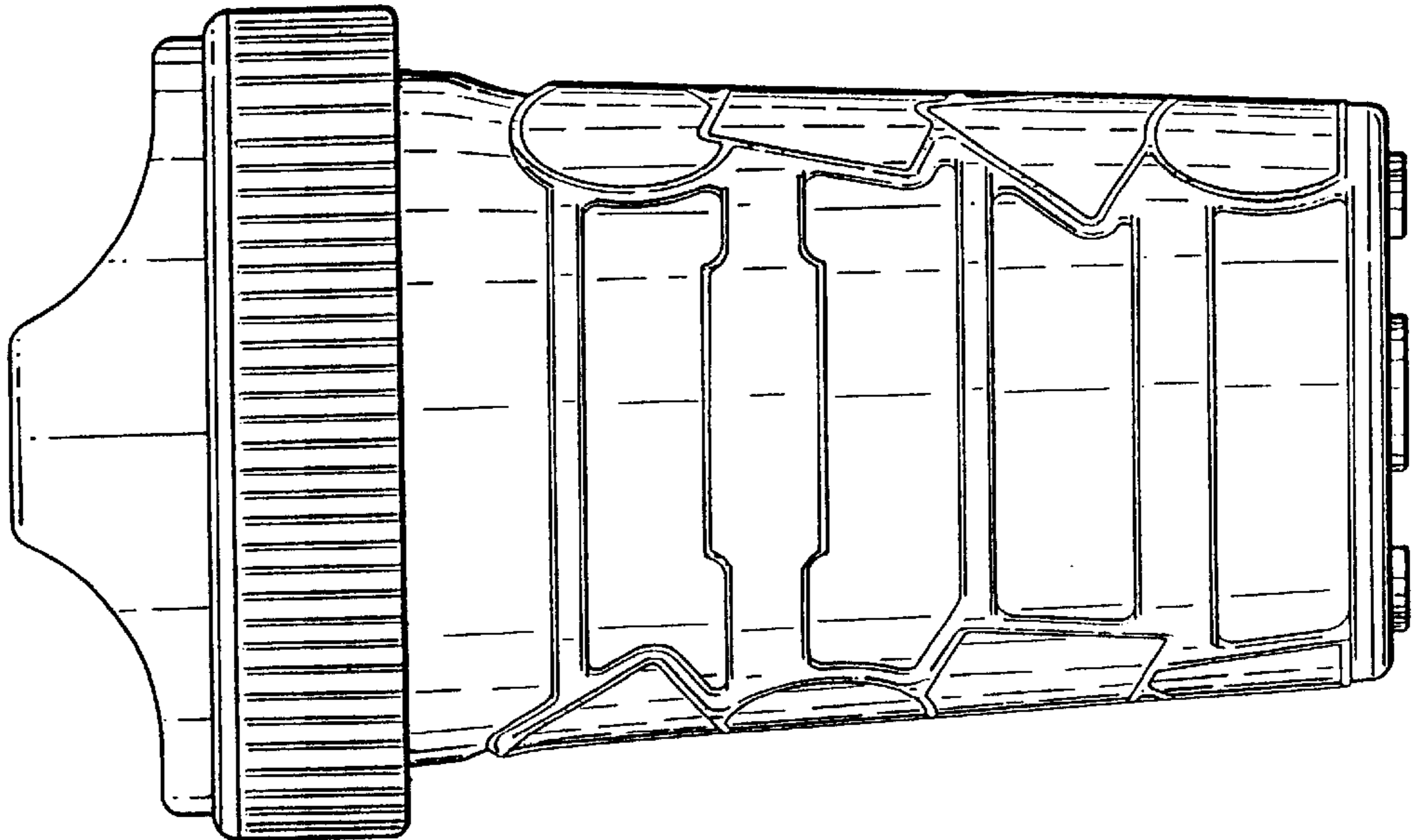

FIG. 19

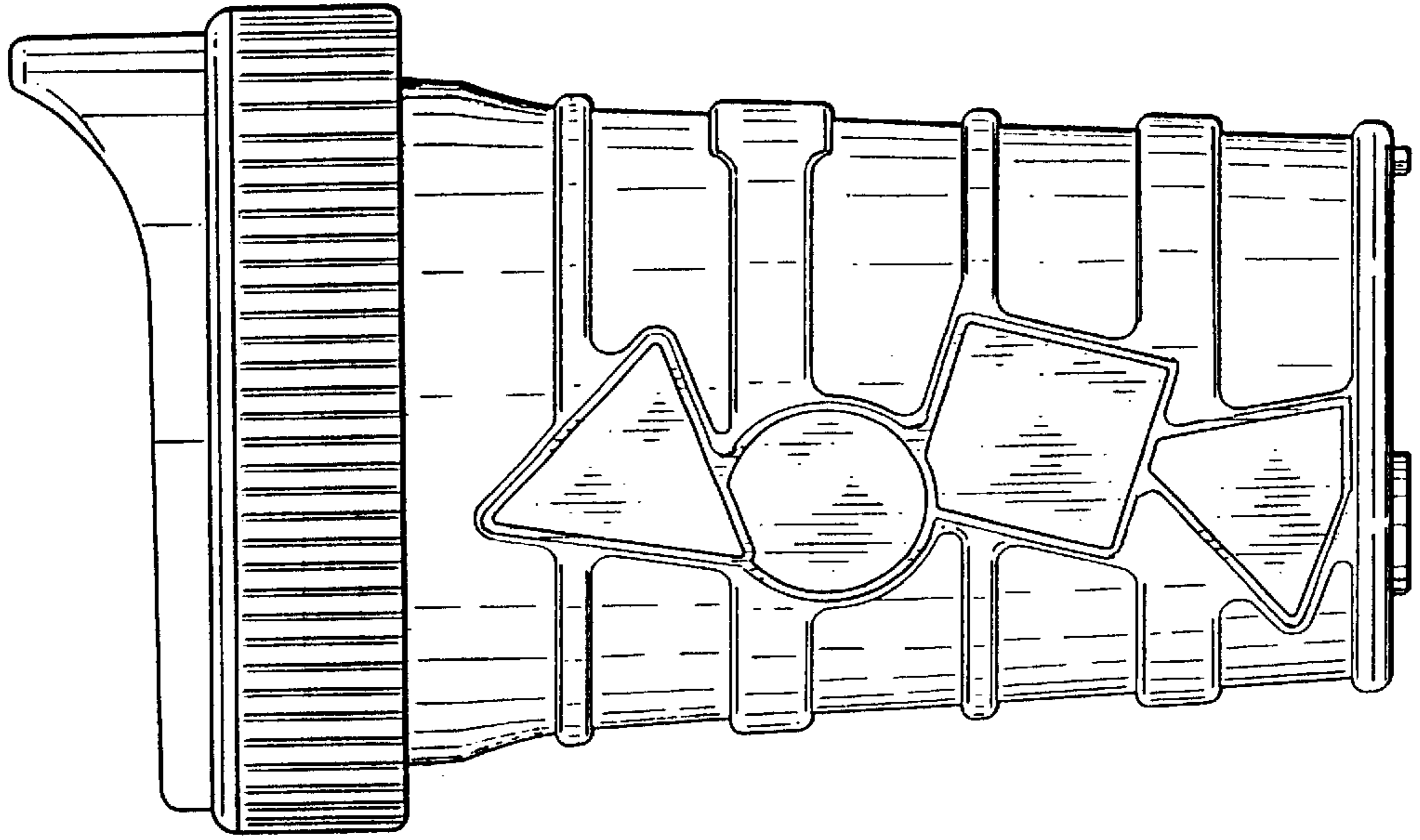

FIG. 18

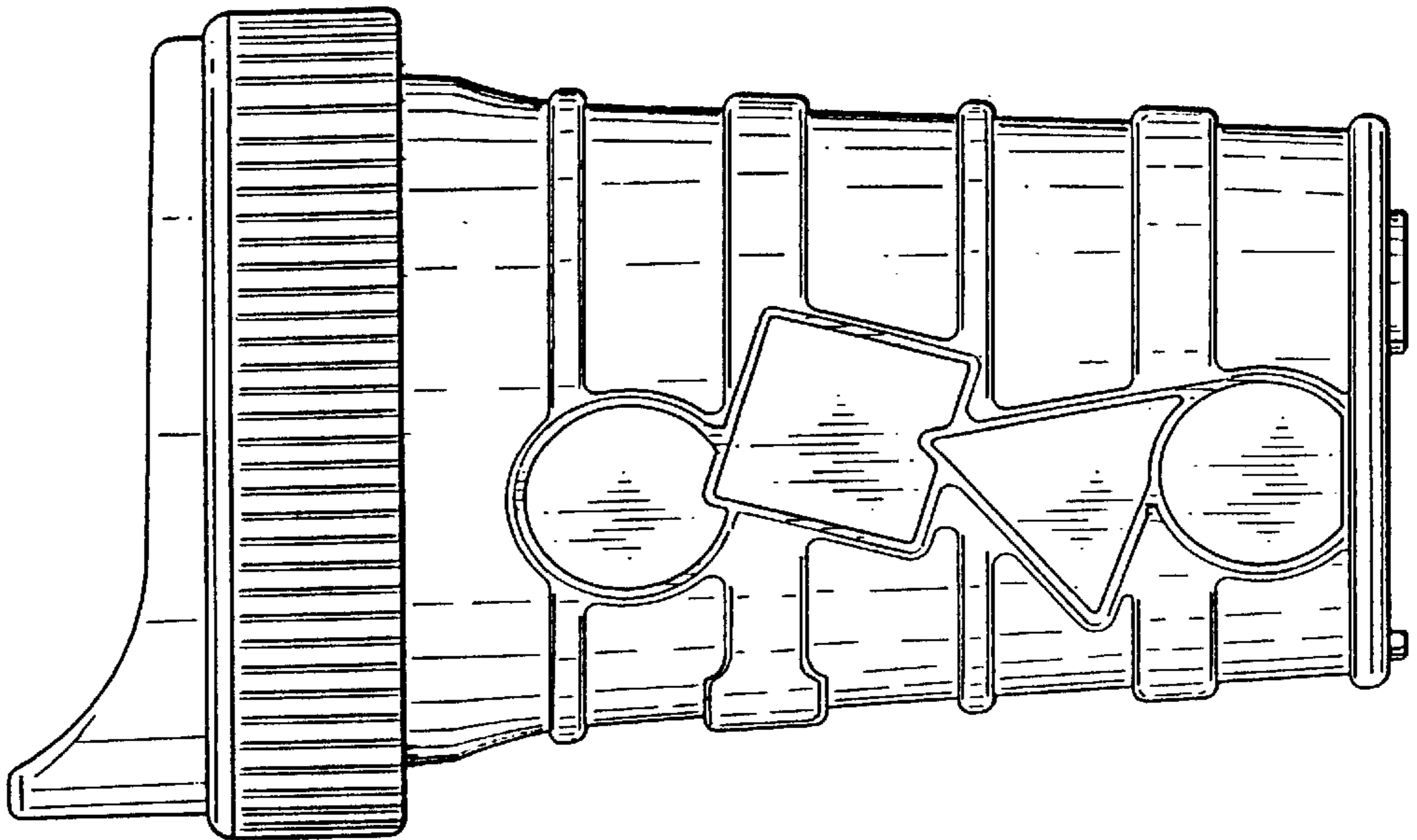

FIG. 20

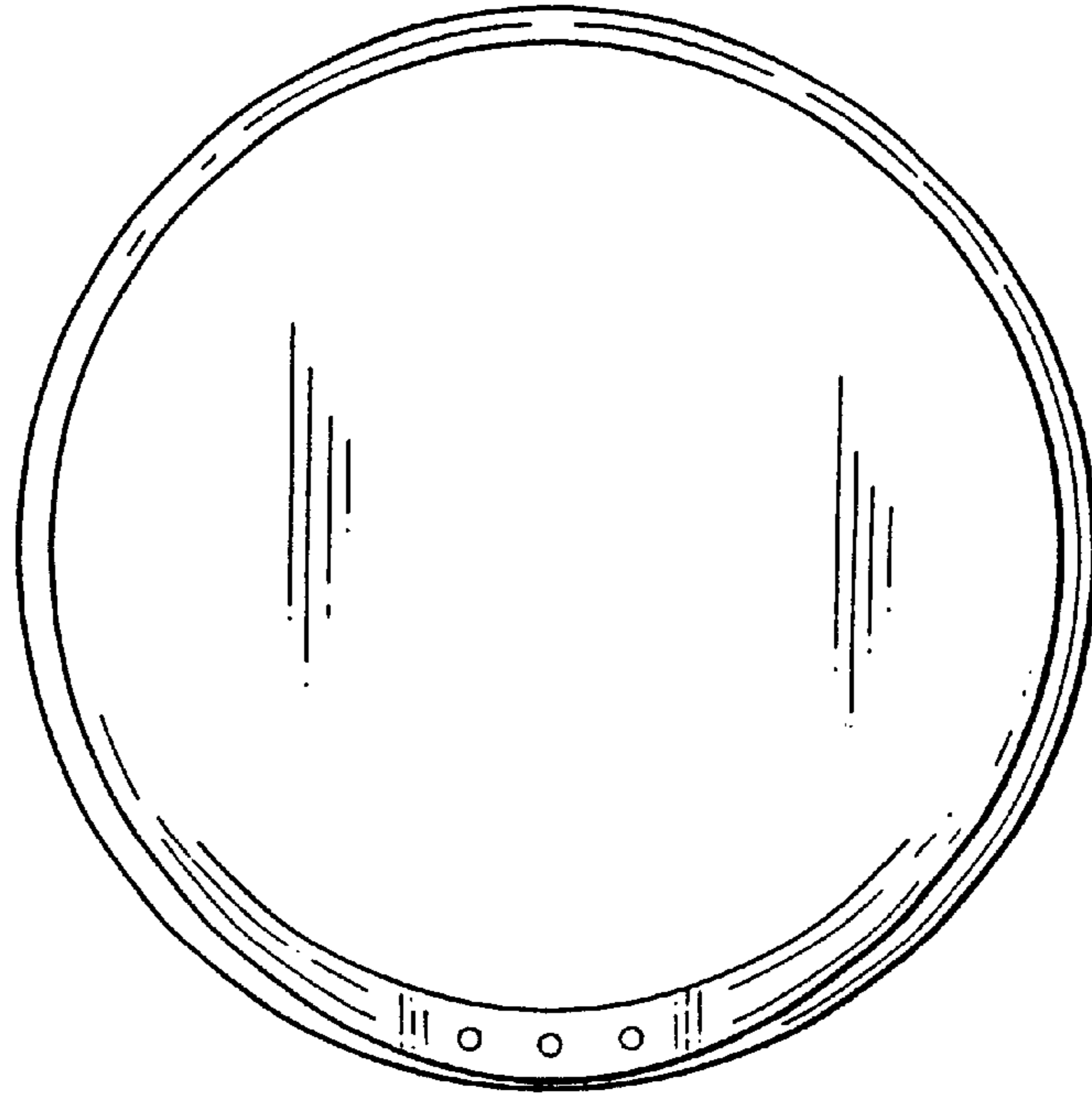

FIG. 21

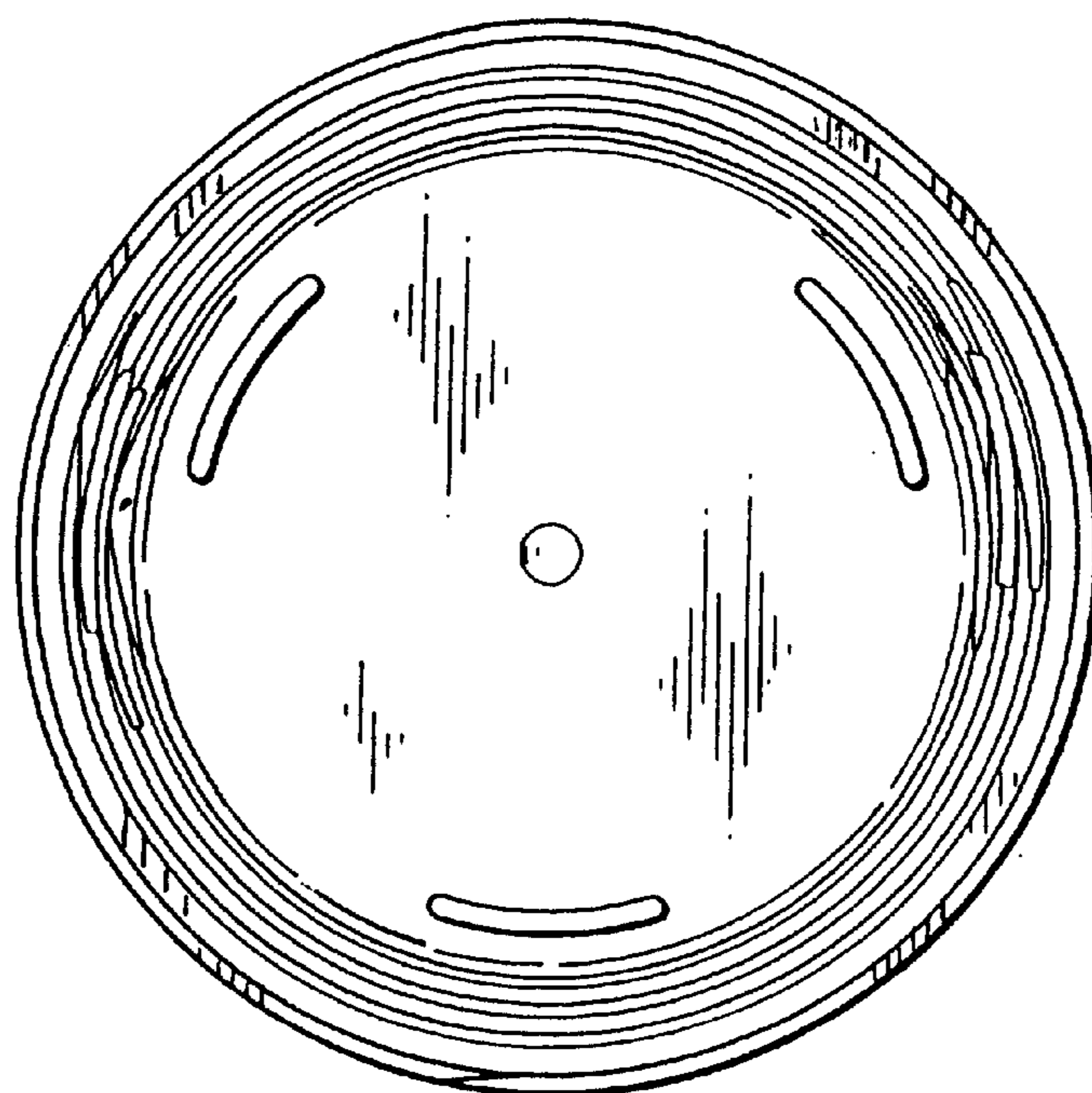

FIG. 22

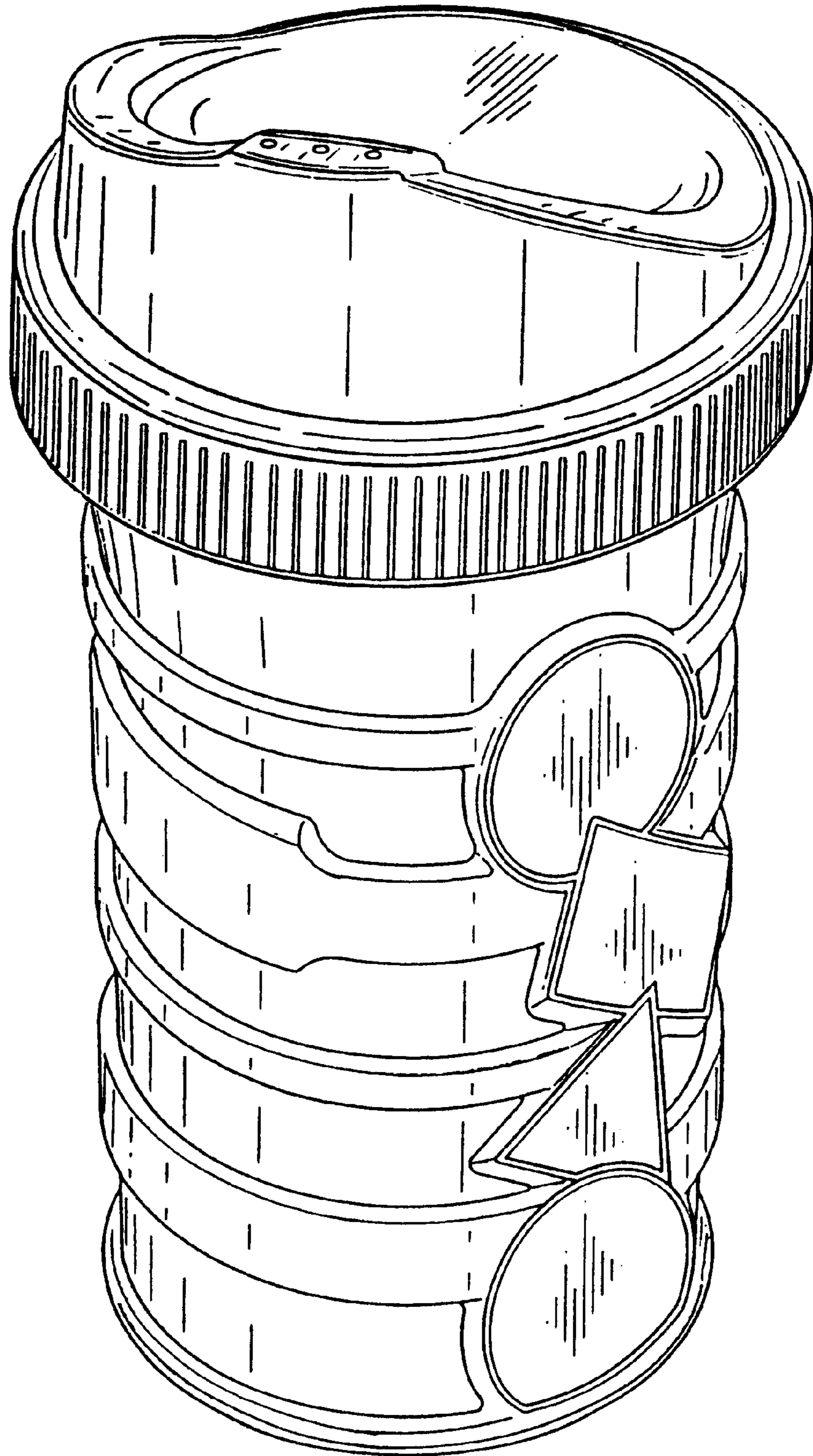

FIG. 24

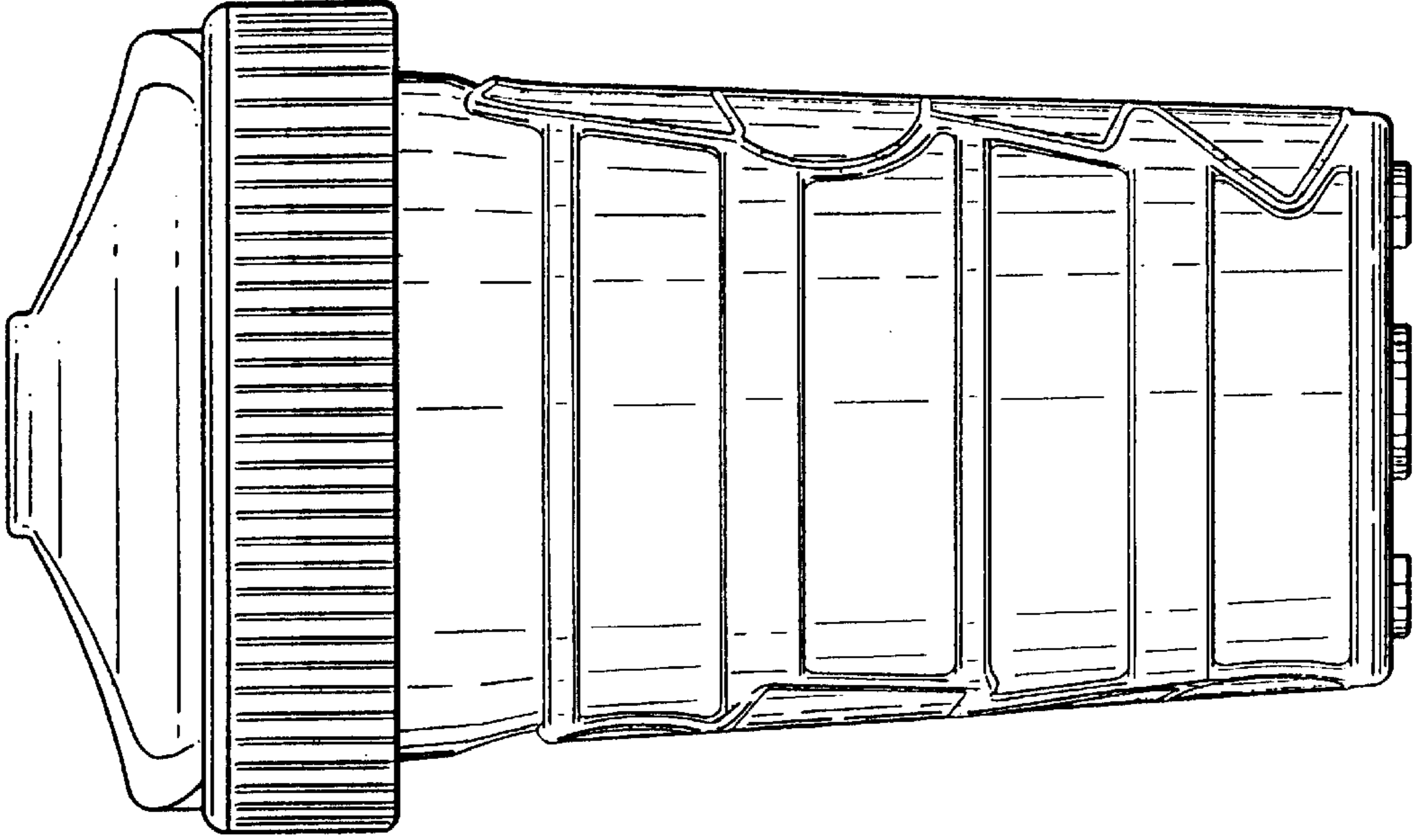

FIG. 23

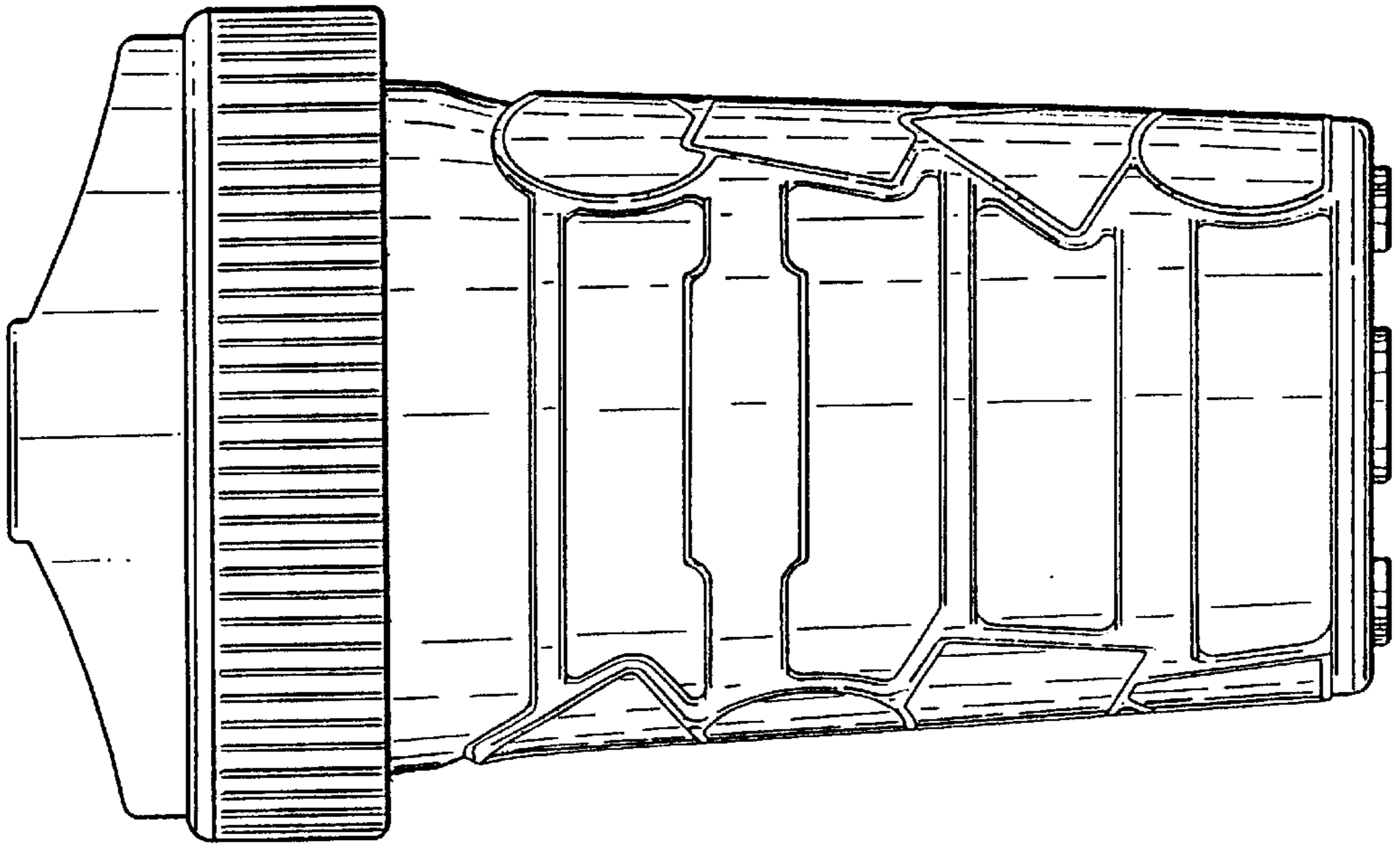

FIG. 26

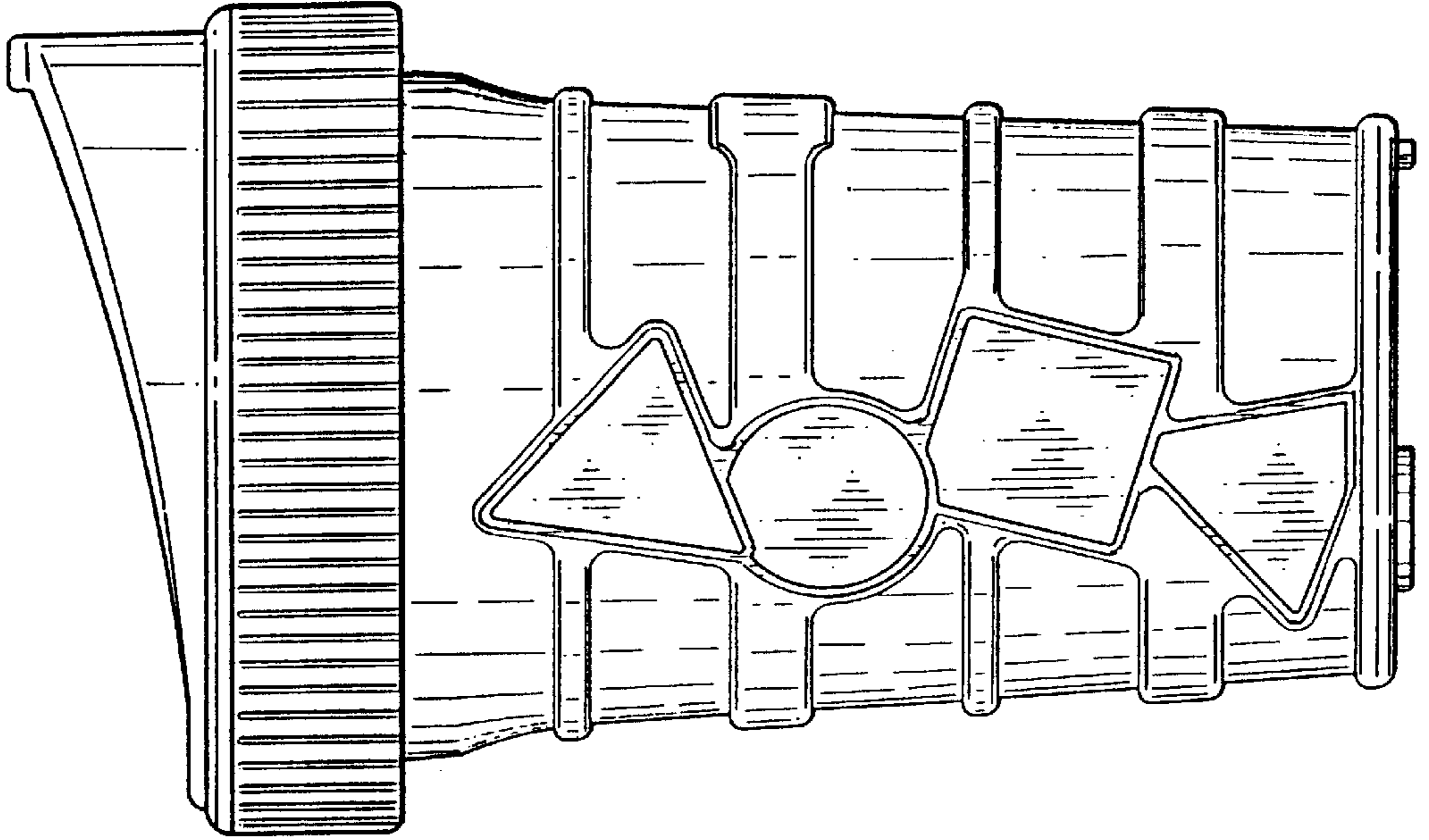

FIG. 25

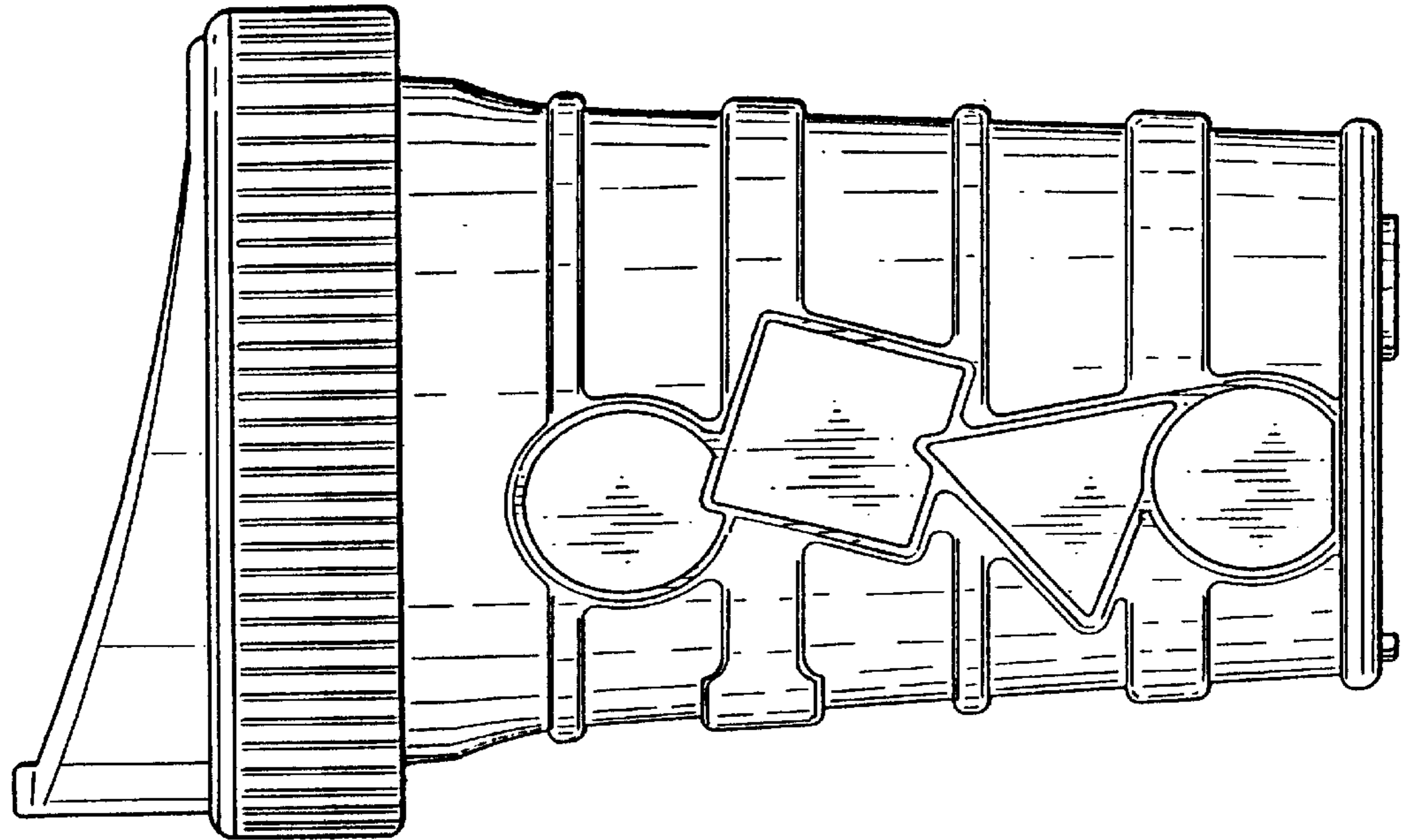

FIG. 27

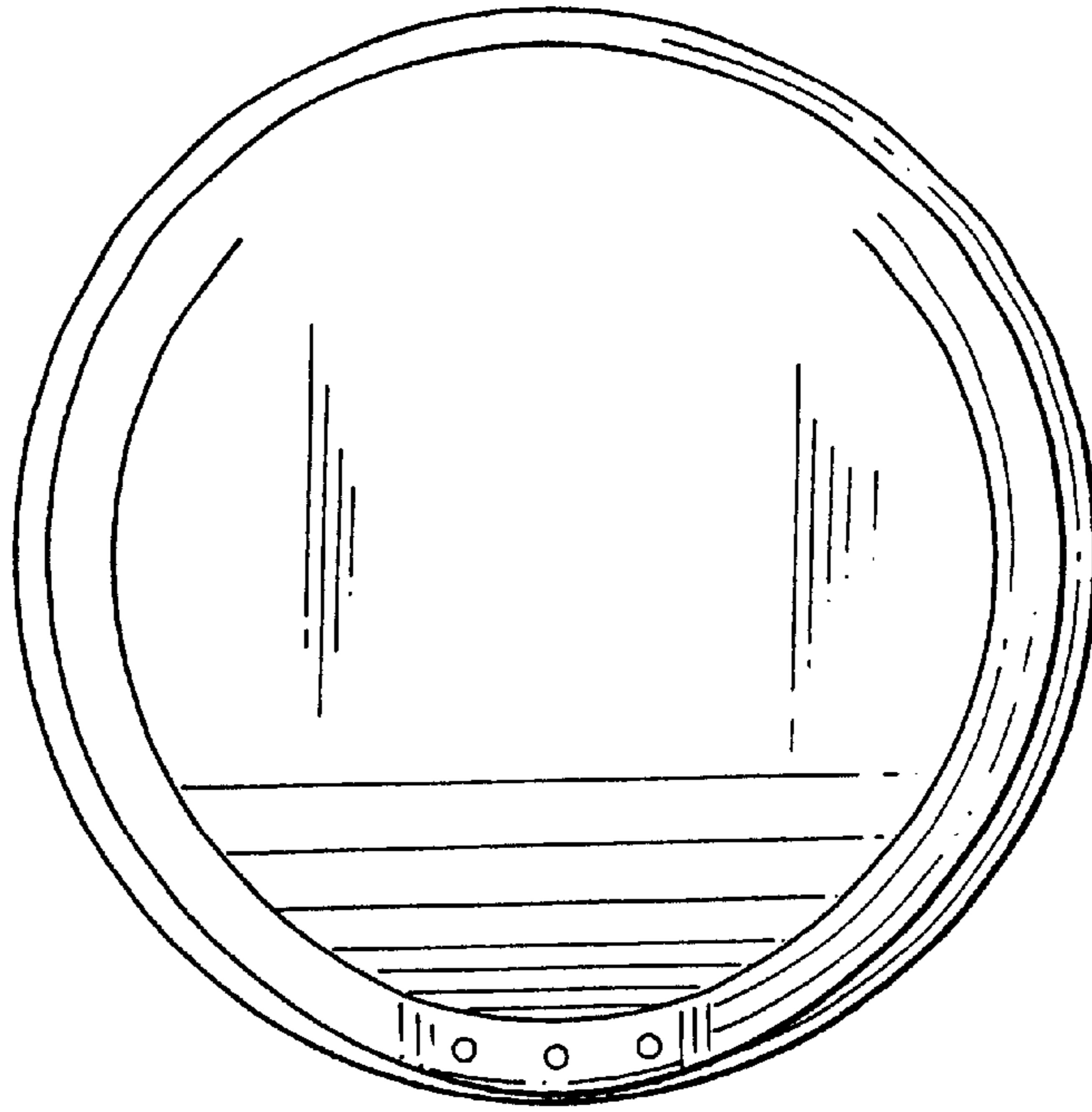

FIG. 28

