



US00D452088B1

(12) **United States Design Patent**  
**Hokanson**

(10) **Patent No.:** **US D452,088 S**

(45) **Date of Patent:** **\*\* Dec. 18, 2001**

(54) **FURNITURE UNIT**

(75) **Inventor:** **Gary Hokanson**, Martinsville, VA (US)

(73) **Assignee:** **Stanley Furniture Company, Inc.**,  
Stanleytown, VA (US)

(\*\*) **Term:** **14 Years**

(21) **Appl. No.:** **29/137,095**

(22) **Filed:** **Feb. 14, 2001**

(51) **LOC (7) Cl.** ..... **06-04**

(52) **U.S. Cl.** ..... **D6/446**

(58) **Field of Search** ..... D6/432-448; 312/204,  
312/224, 257.1

(56) **References Cited**

**U.S. PATENT DOCUMENTS**

D. 98,367	*	1/1936	Pumphrey	.....	D6/446
D. 133,694	*	9/1942	Buckner	.....	D6/441
D. 185,710	*	7/1959	Hermann	.....	D6/446
D. 344,199	*	2/1994	Stephens	.....	D6/446
D. 416,144	*	11/1999	Walters, III et al.	.....	D6/437
D. 428,280	*	7/2000	Walters, III et al.	.....	D6/446
D. 430,425	*	9/2000	Hazen et al.	.....	D6/438

\* cited by examiner

*Primary Examiner*—Cathron C. Brooks

(74) *Attorney, Agent, or Firm*—McGuireWoods LLP

(57) **CLAIM**

The ornamental design for a furniture unit, as shown.

**DESCRIPTION**

FIG. 1 is a perspective view of a first embodiment of a furniture unit;

FIG. 2 is a front elevational view of the first embodiment of the furniture unit;

FIG. 3 is a rear elevational view of the first embodiment of the furniture unit;

FIG. 4 is a top elevational view of the first embodiment of the furniture unit;

FIG. 5 is a side elevational view of the first embodiment of the furniture unit;

FIG. 6 is a side elevational view of the first embodiment of the furniture unit;

FIG. 7 is a perspective view of a second embodiment of a furniture unit;

FIG. 8 is a front elevational view of the second embodiment of the furniture unit;

FIG. 9 is a rear elevational view of the second embodiment of the furniture unit;

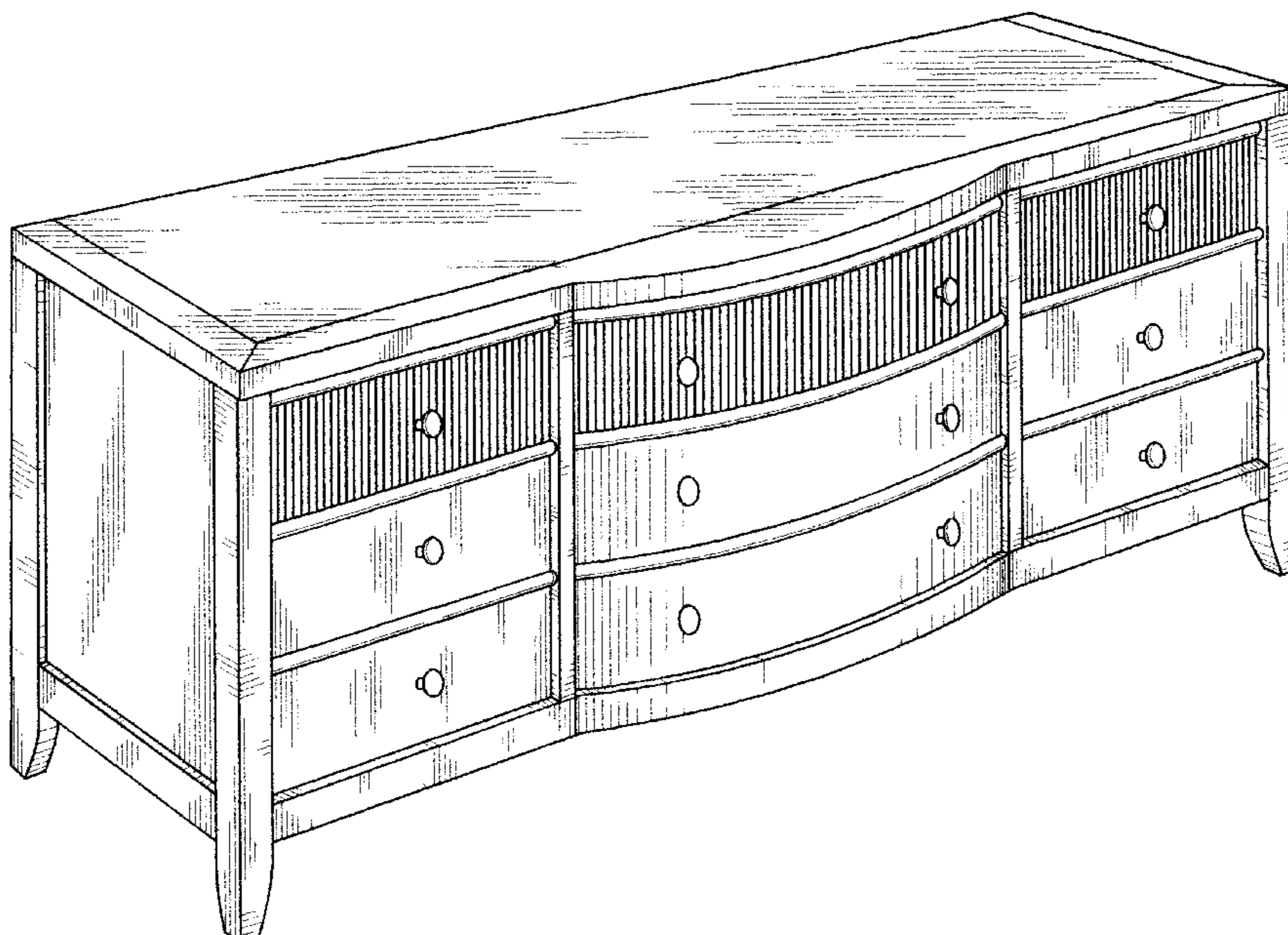
FIG. 10 is a top elevational view of the second embodiment of the furniture unit;

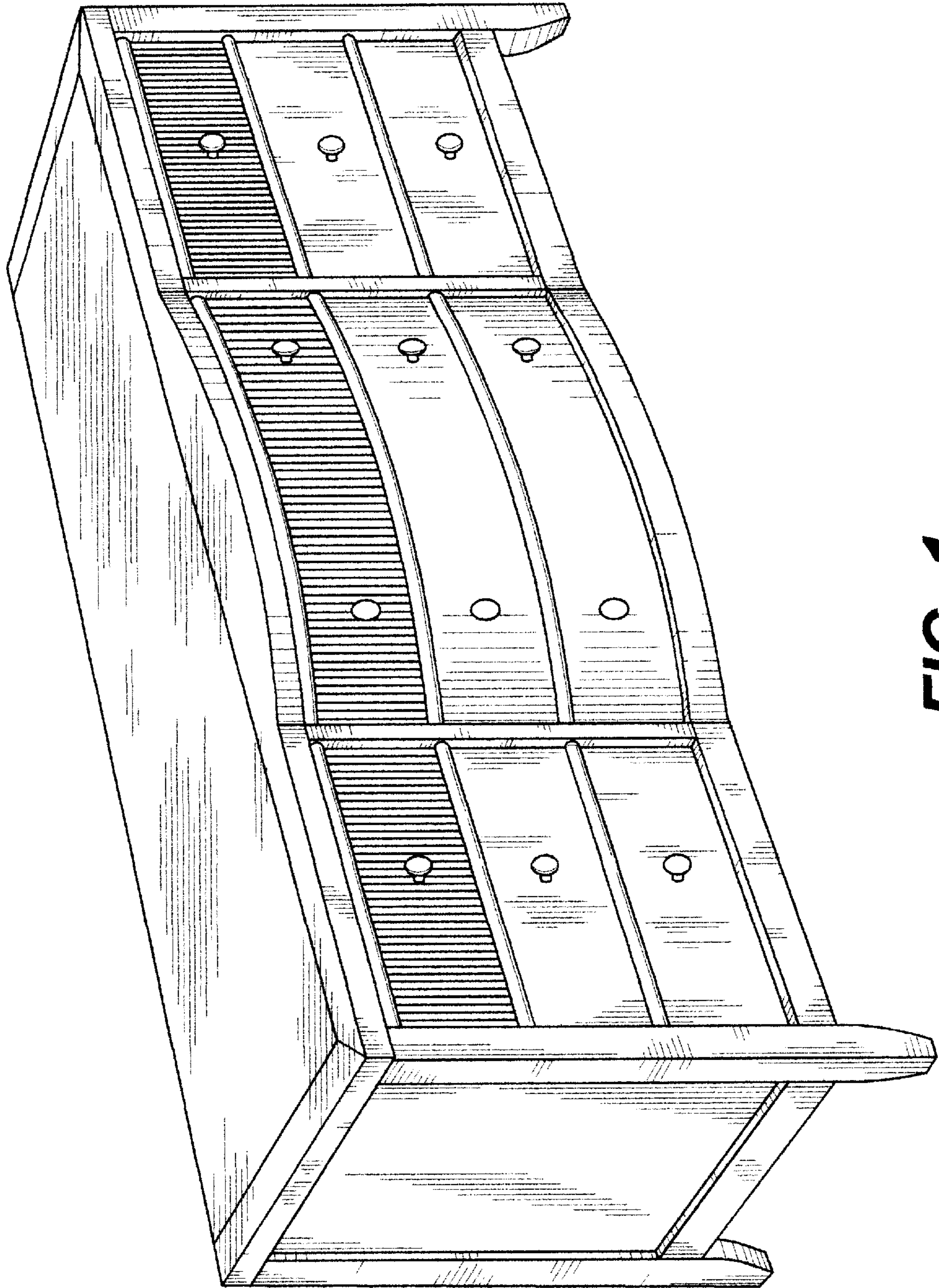
FIG. 11 is a side elevational view of the second embodiment of the furniture unit; and,

FIG. 12 is a side elevational view of the second embodiment of the furniture unit.

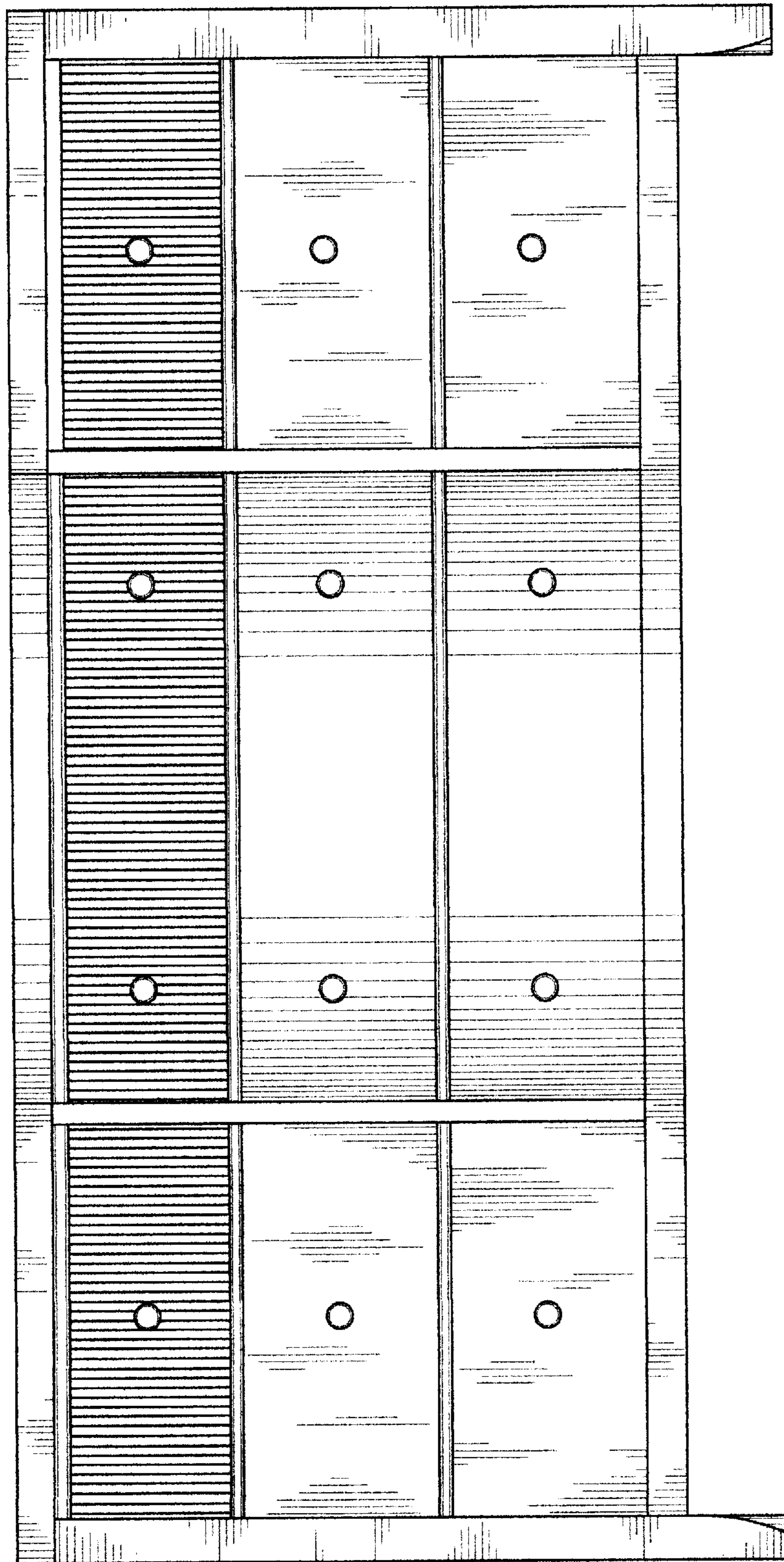
The broken lines are for illustrative purposes only and form no part of the claimed design.

**1 Claim, 12 Drawing Sheets**

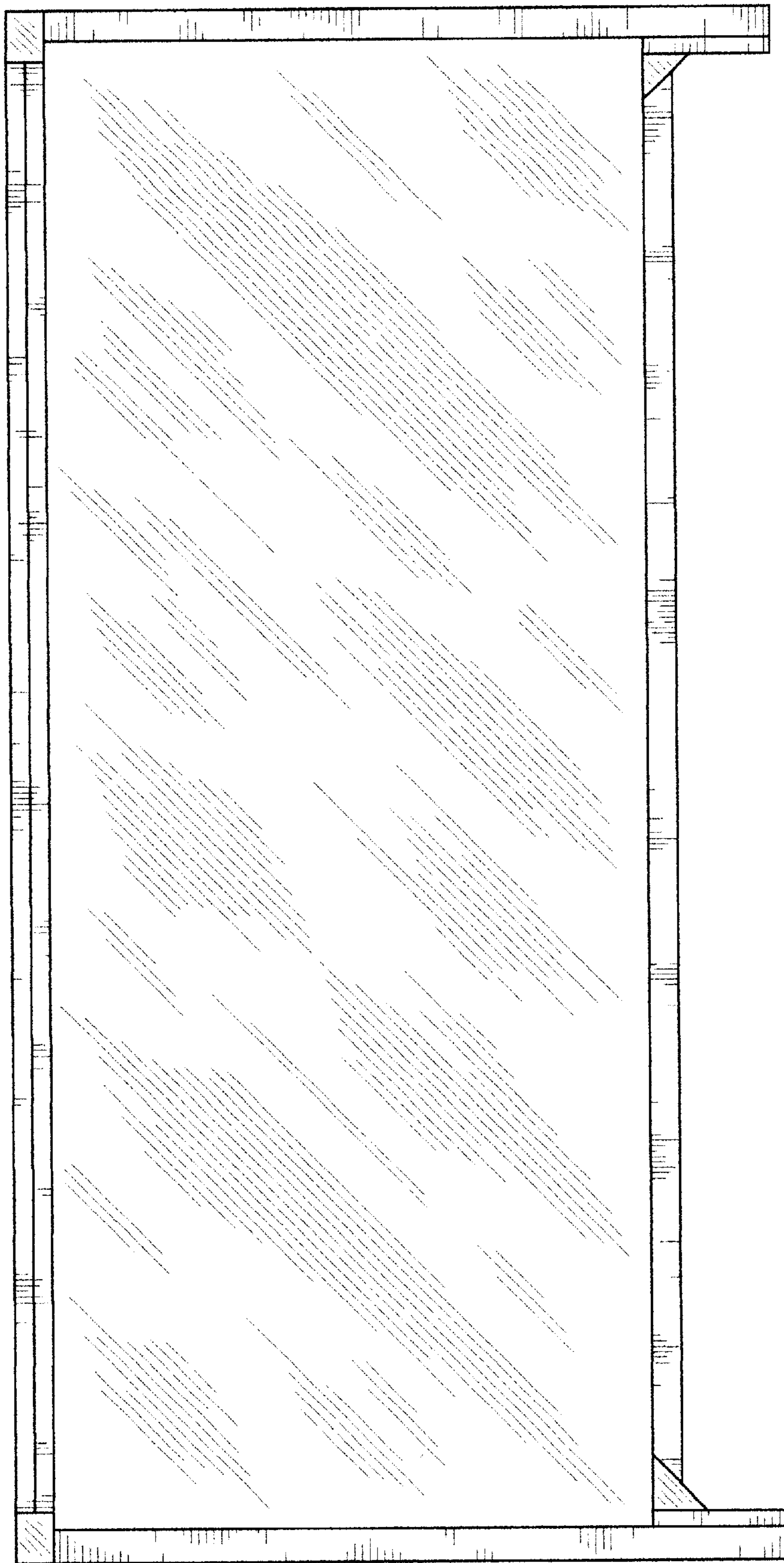




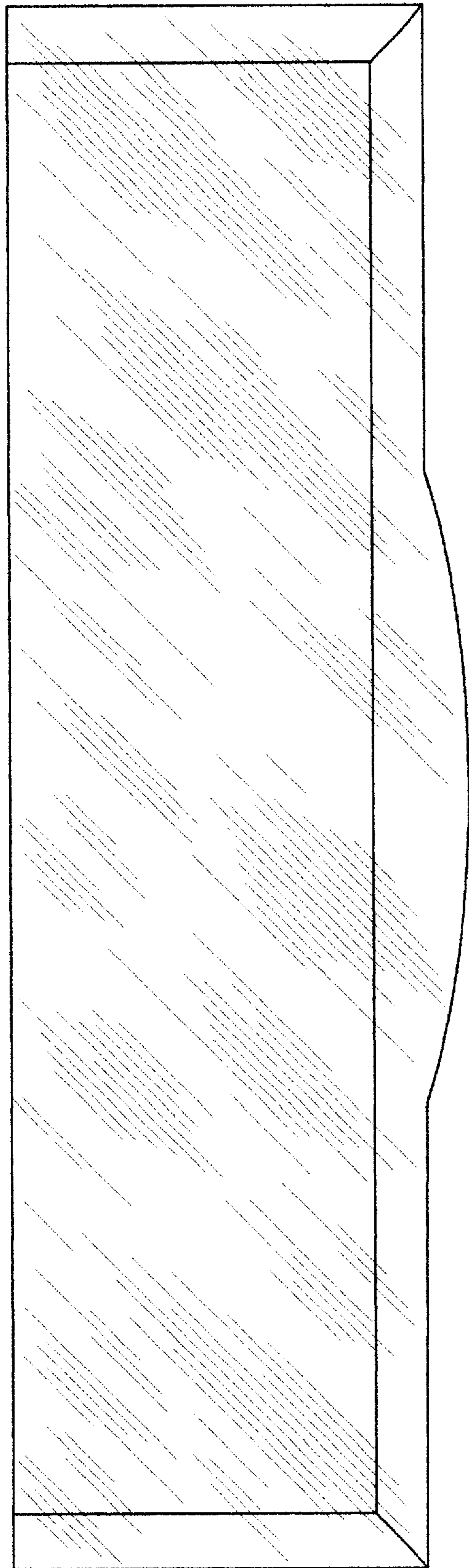
**FIG. 1**



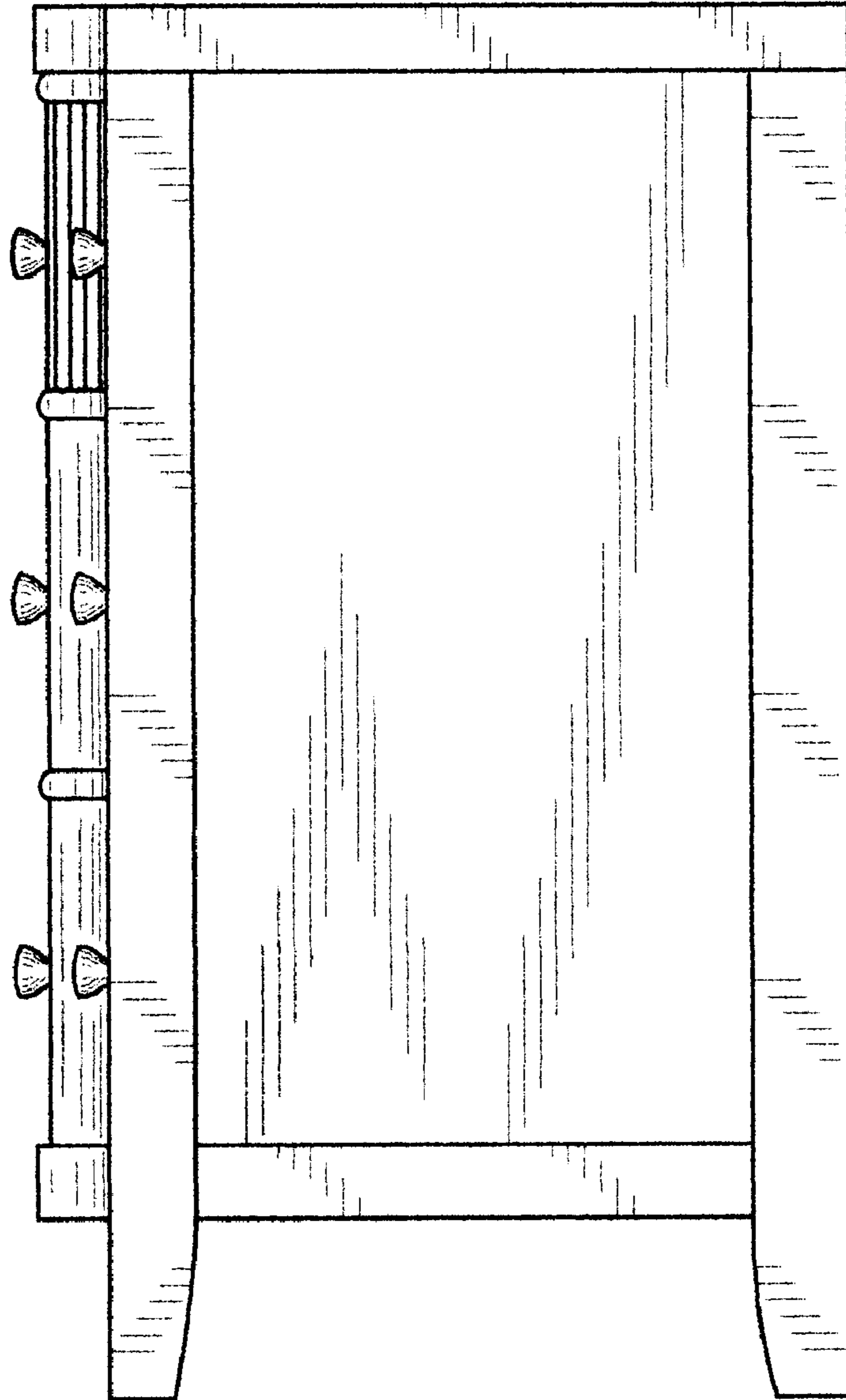
**FIG. 2**



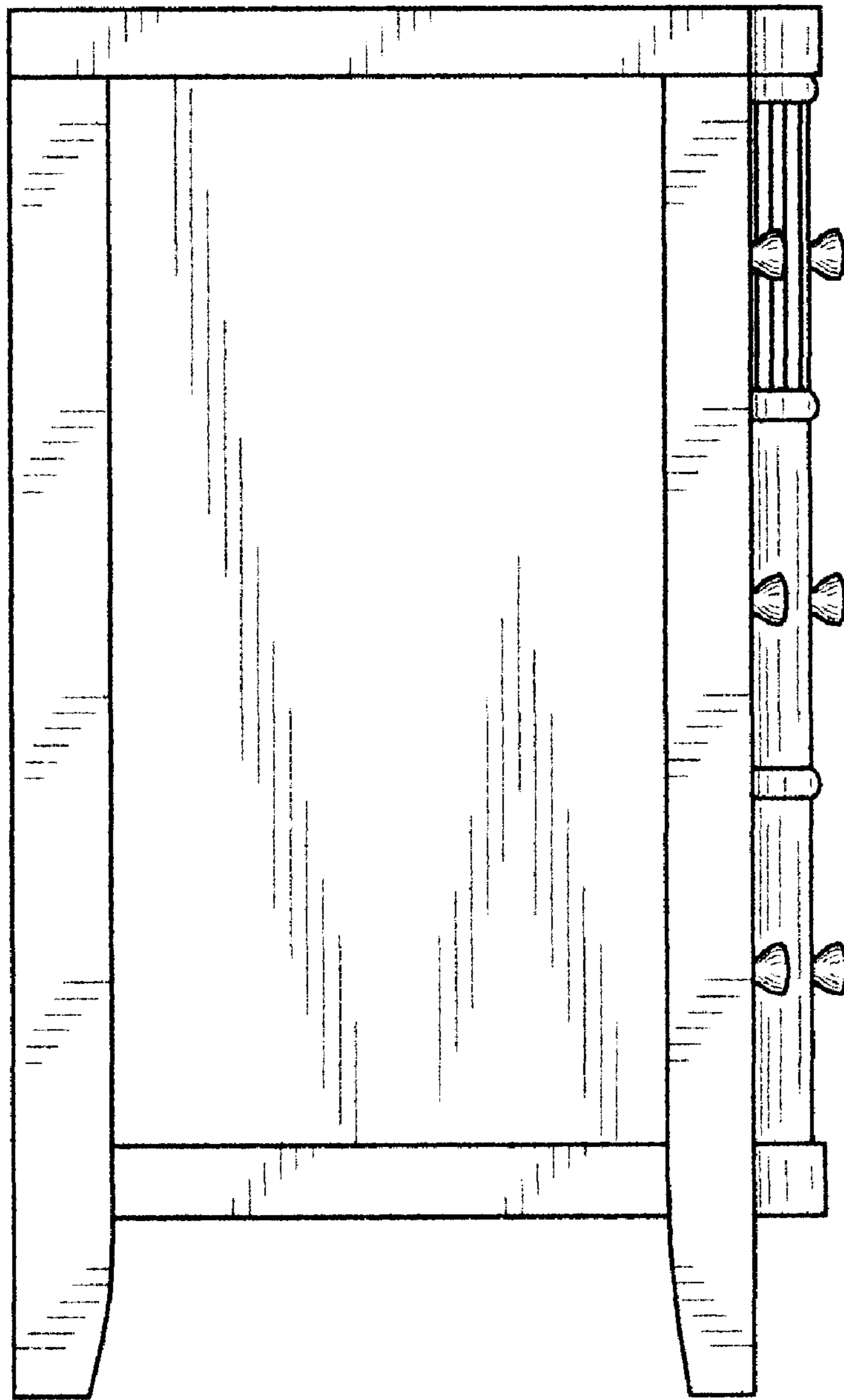
**FIG. 3**



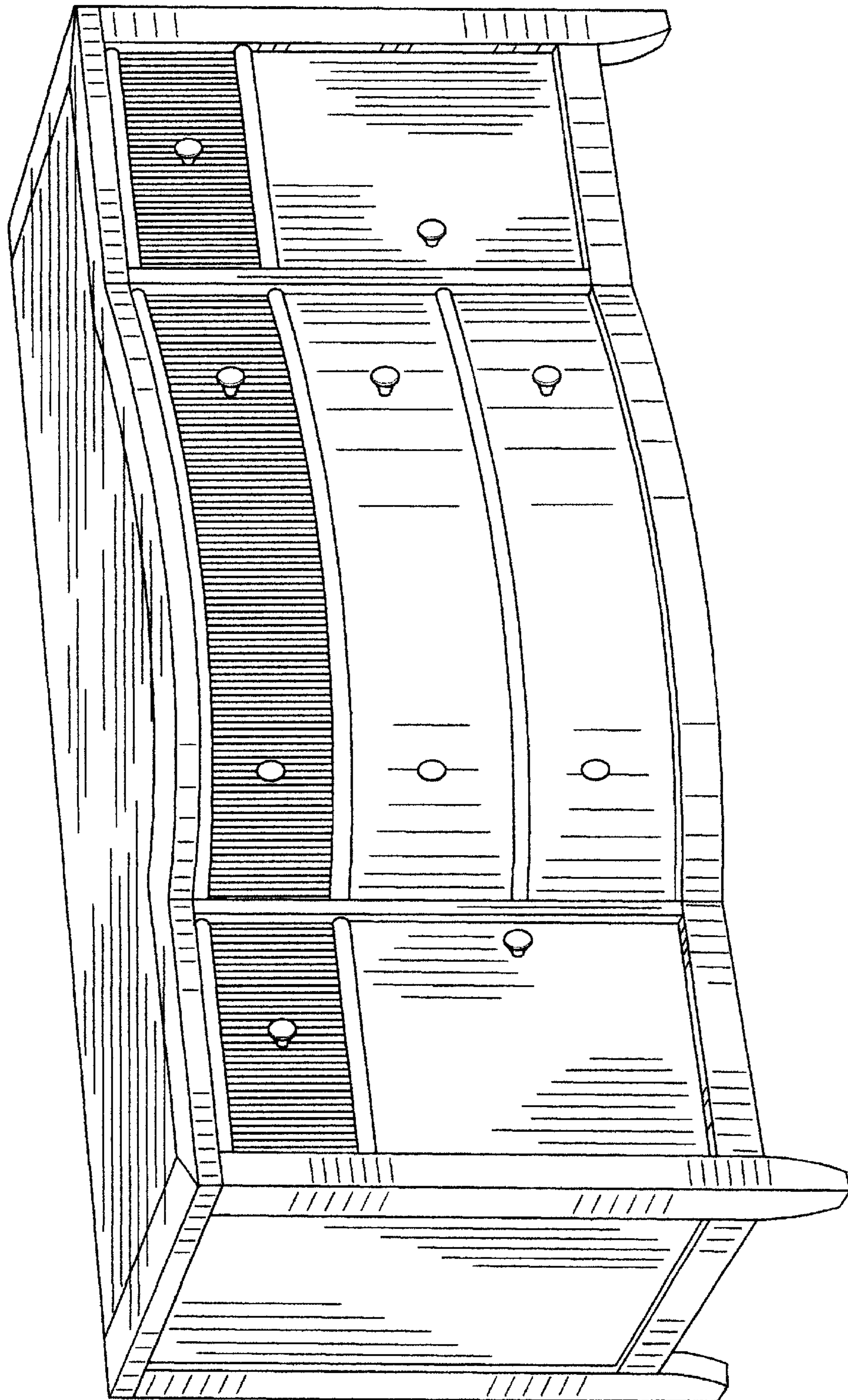
**FIG. 4**



**FIG. 5**

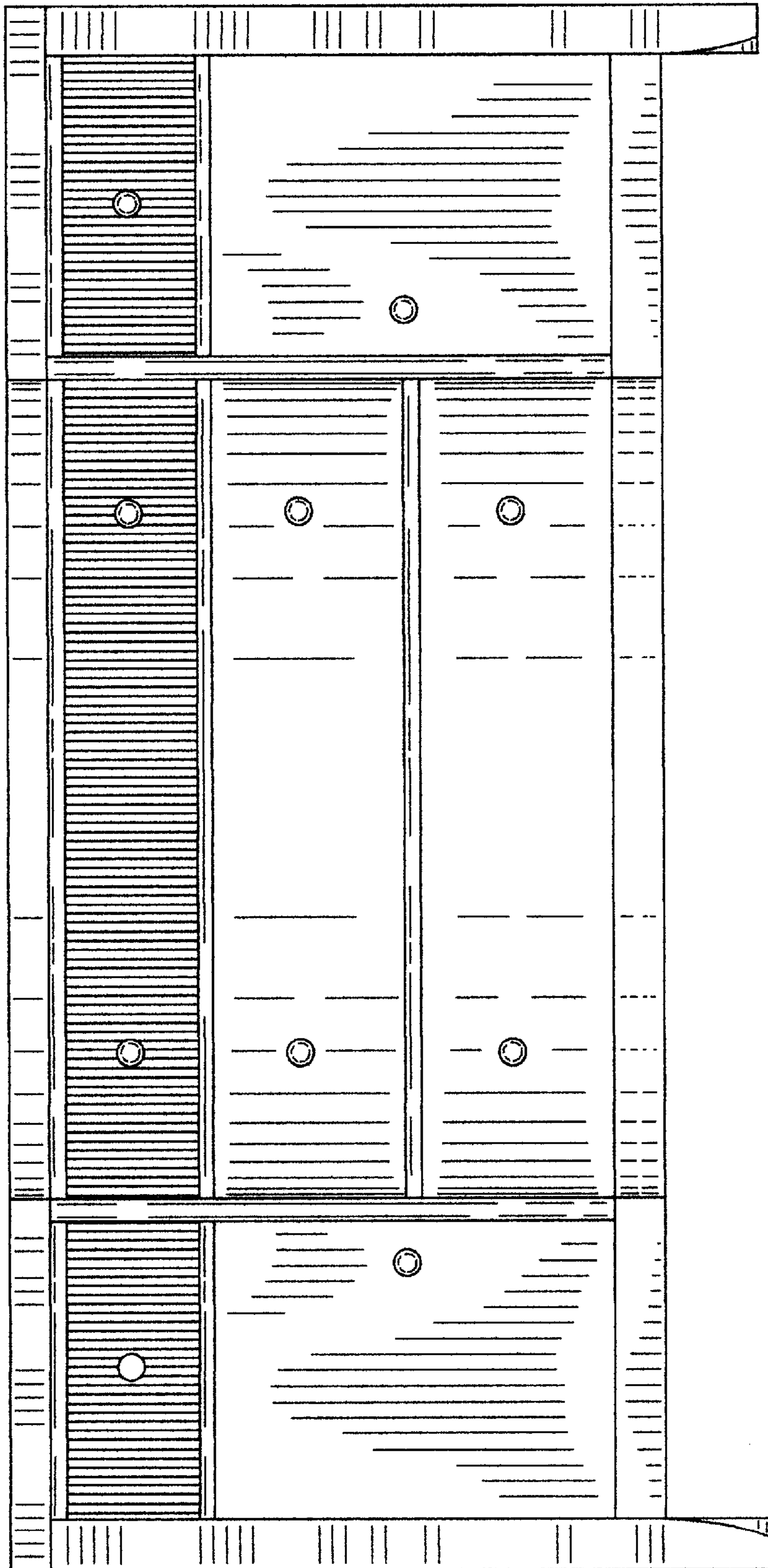


**FIG. 6**

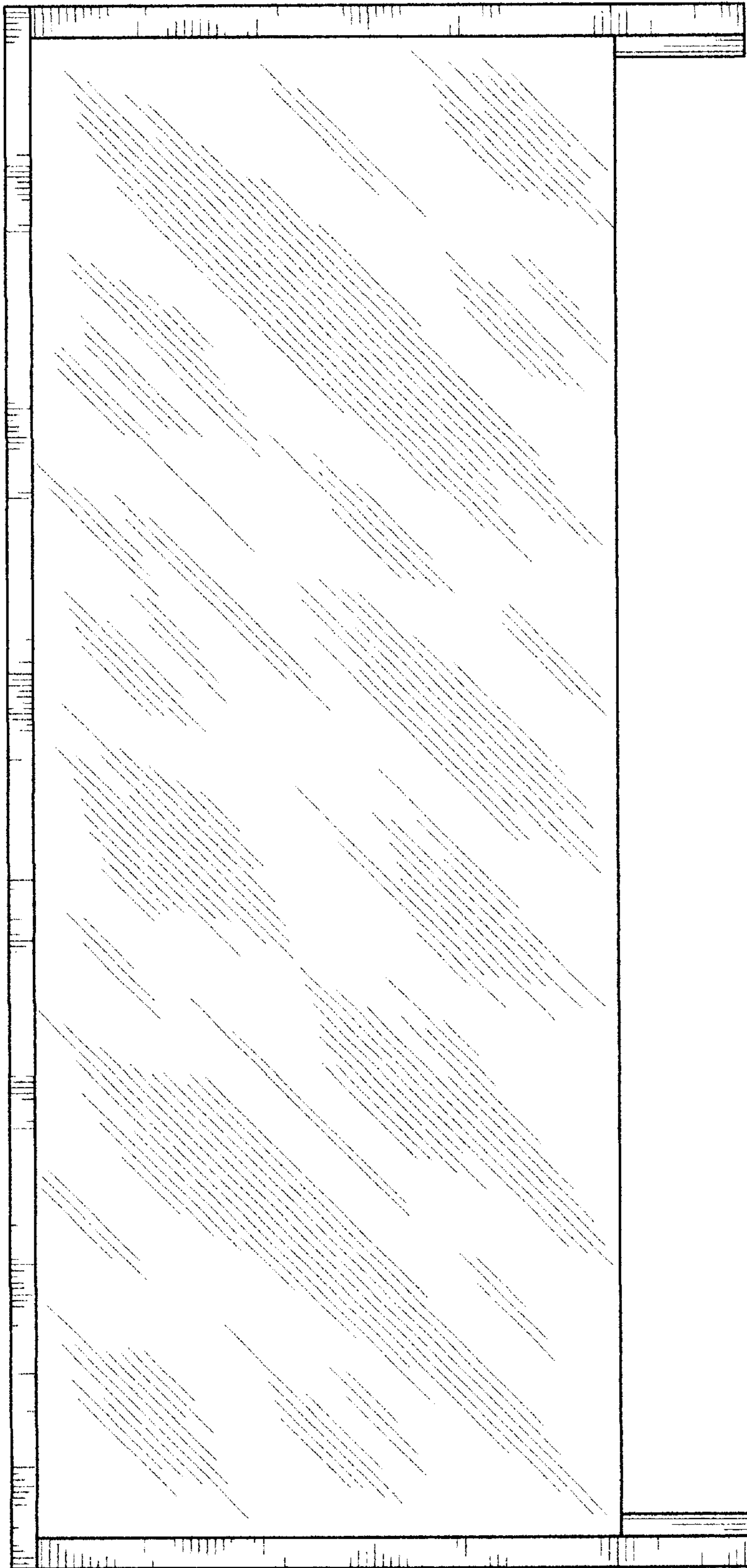


**FIG. 7**

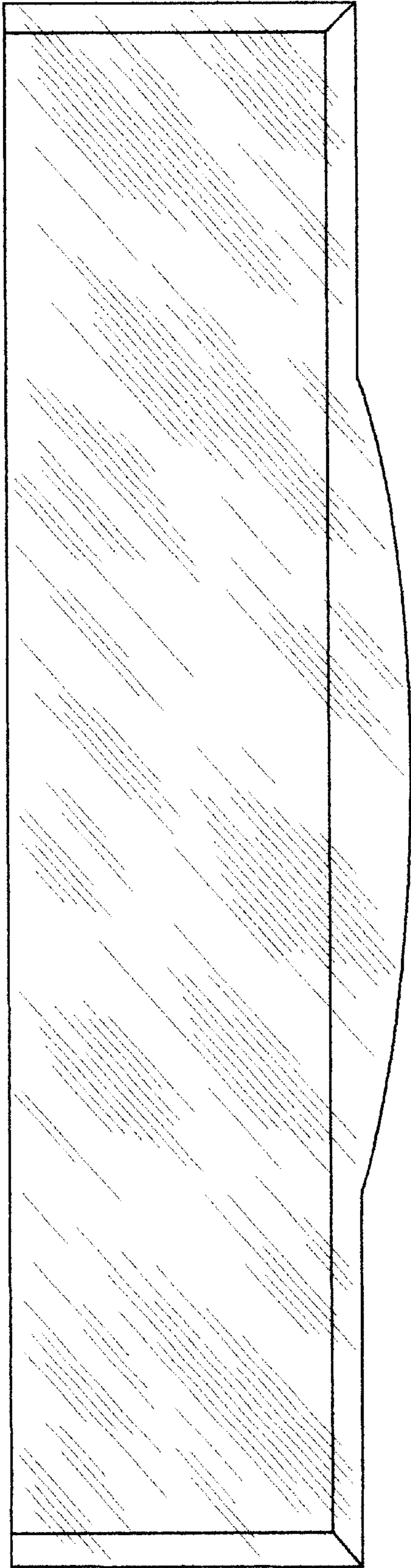




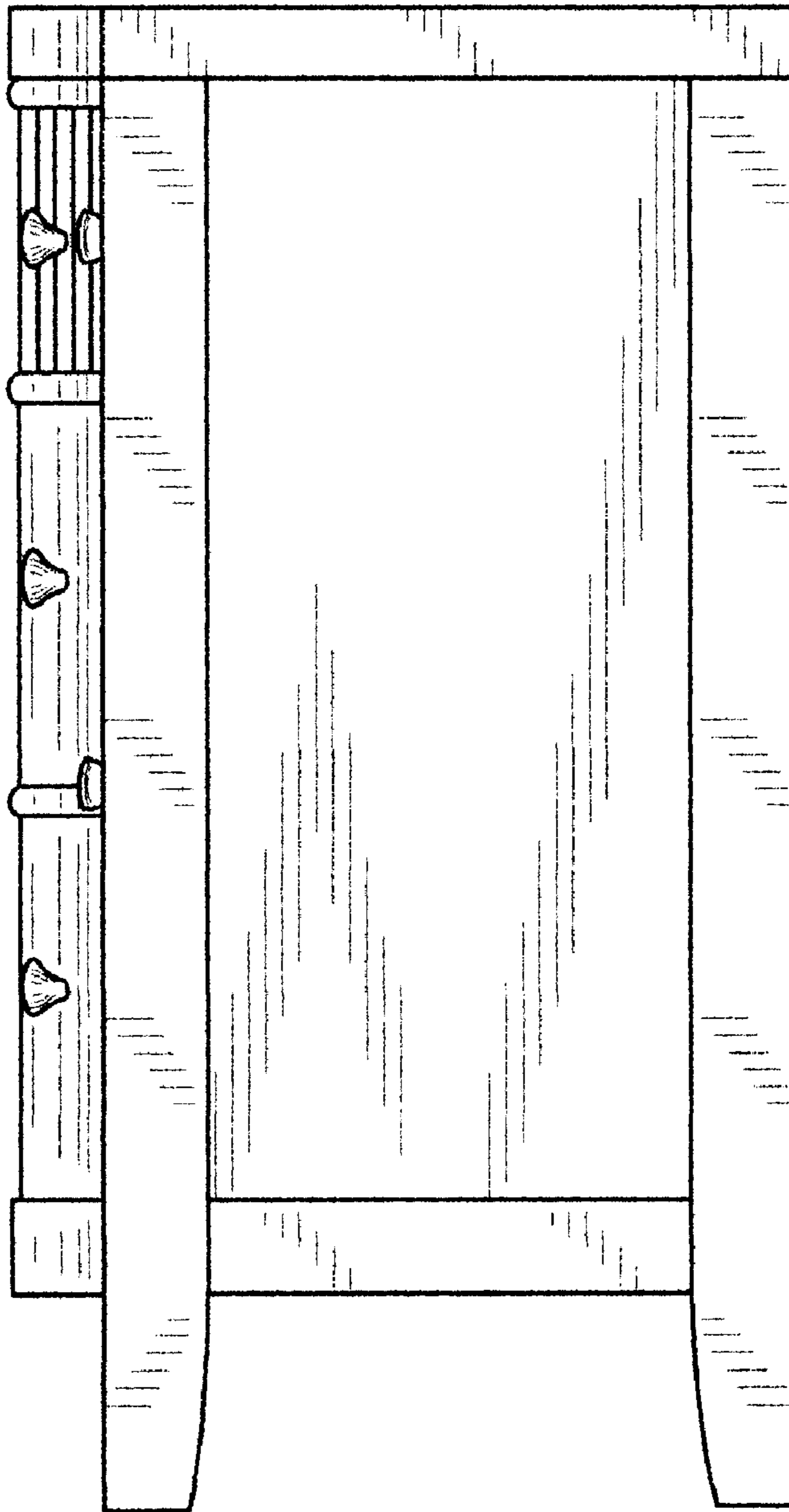
**FIG. 8**



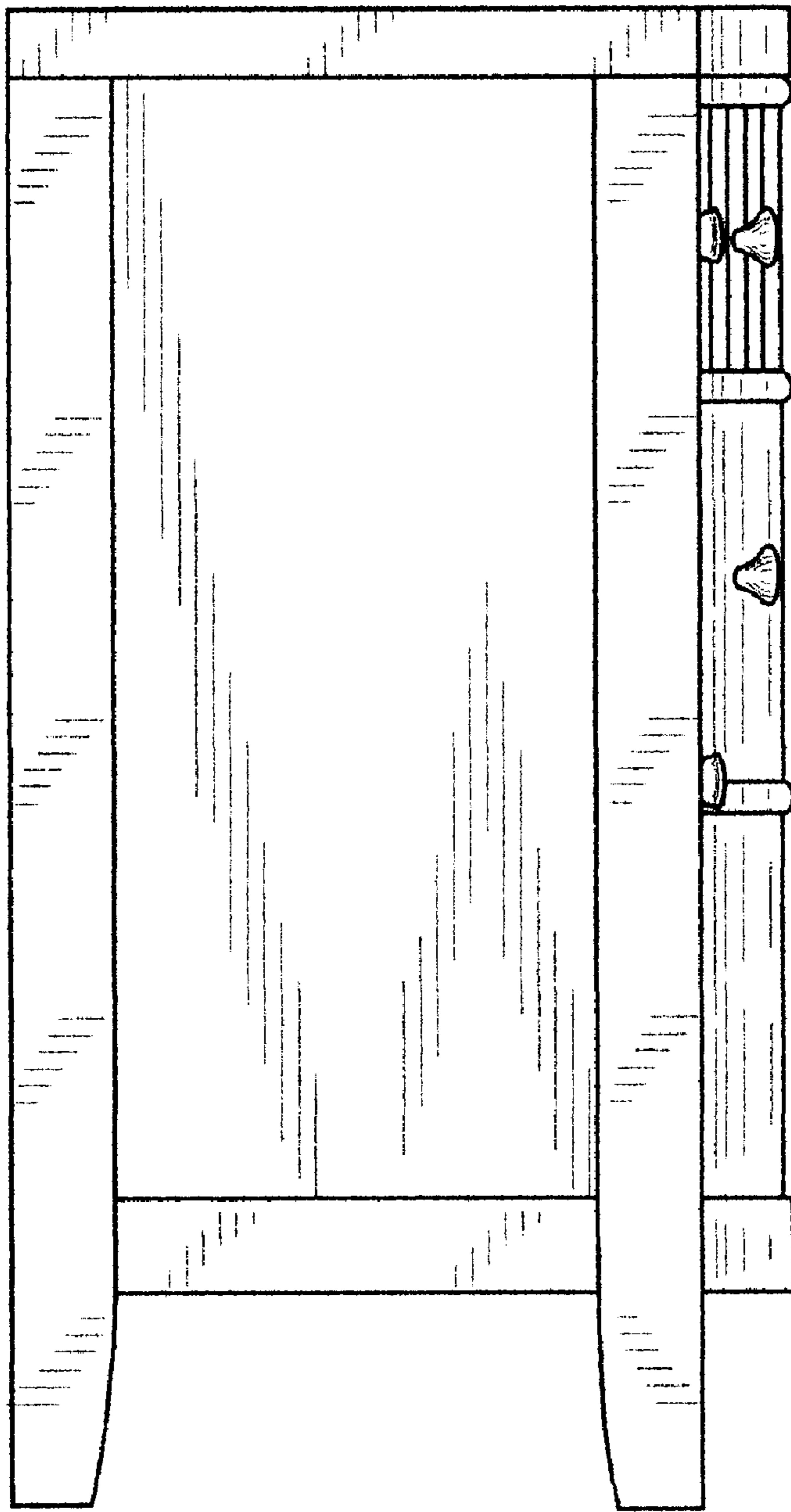
**FIG. 9**



**FIG. 10**



**FIG. 11**



**FIG. 12**