



US00D452003B1

(12) **United States Design Patent**  
**Niermann**

(10) **Patent No.:** **US D452,003 S**

(45) **Date of Patent:** **\*\* Dec. 11, 2001**

(54) **NEEDLE ASSEMBLY**

(75) Inventor: **Volker Niermann**, Little Falls, NJ (US)

(73) Assignee: **Becton, Dickinson and Company**,  
Franklin Lakes, NJ (US)

(\*\*) Term: **14 Years**

(21) Appl. No.: **29/135,213**

(22) Filed: **Jan. 8, 2001**

(51) **LOC (7) Cl.** ..... **24-02**

(52) **U.S. Cl.** ..... **D24/112; D24/130**

(58) **Field of Search** ..... D24/112, 130,  
D24/146; 604/198, 192, 263, 164.01, 168.01,  
177, 110, 171

5,738,665 4/1998 Caizza et al. .  
5,830,190 \* 11/1998 Howell ..... 604/168.01  
5,833,670 11/1998 Dillon et al. .  
6,050,976 \* 4/2000 Thorne et al. .... 604/164

**FOREIGN PATENT DOCUMENTS**

2 301 036 A 11/1996 (GB) .  
WO 94/19036 9/1994 (WO) .

\* cited by examiner

*Primary Examiner*—Ian Simmons

(74) *Attorney, Agent, or Firm*—Nanette S. Thomas

(57) **CLAIM**

The ornamental design of a needle assembly, as shown and described.

**DESCRIPTION**

FIG. 1 is a perspective view of the needle assembly;  
FIG. 2 is a top plan view thereof;  
FIG. 3 is a left side elevational view thereof, with the right  
side elevational view being a mirror image thereof;  
FIG. 4 is a front elevational view thereof;  
FIG. 5 is a rear elevational view thereof; and,  
FIG. 6 is a bottom plan view thereof.

**1 Claim, 5 Drawing Sheets**

(56) **References Cited**

**U.S. PATENT DOCUMENTS**

D. 376,200 \* 12/1996 Lindgren et al. .... D24/112  
D. 376,645 \* 12/1996 Lindgren et al. .... D24/112  
D. 417,733 \* 12/1999 Howell et al. .... D24/112  
D. 424,194 \* 5/2000 Holdaway et al. .... D24/112  
4,790,828 12/1988 Dombrowski et al. .  
5,328,483 7/1994 Jacoby .  
5,334,155 8/1994 Sobel .  
5,735,827 4/1998 Adwers et al. .

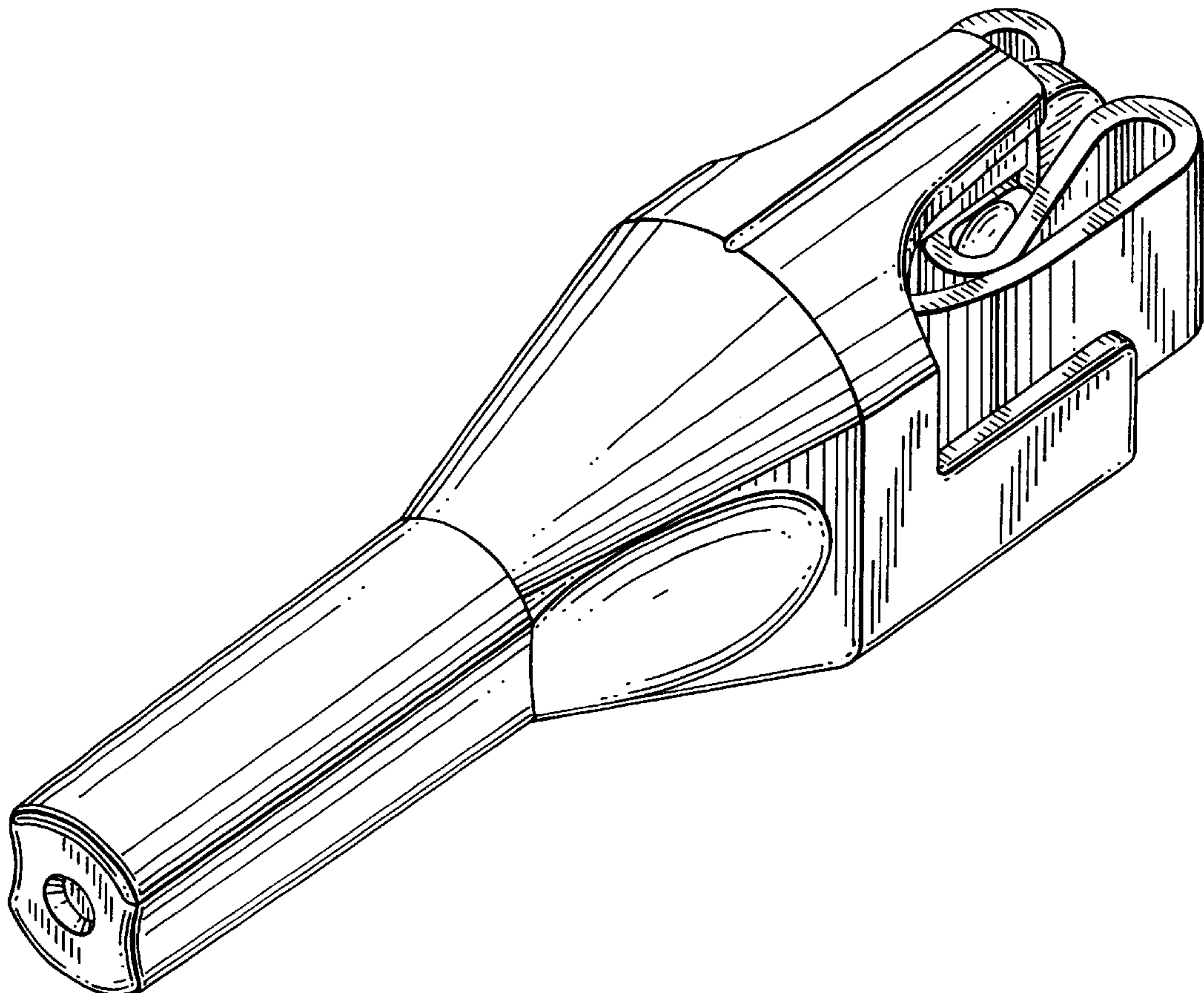

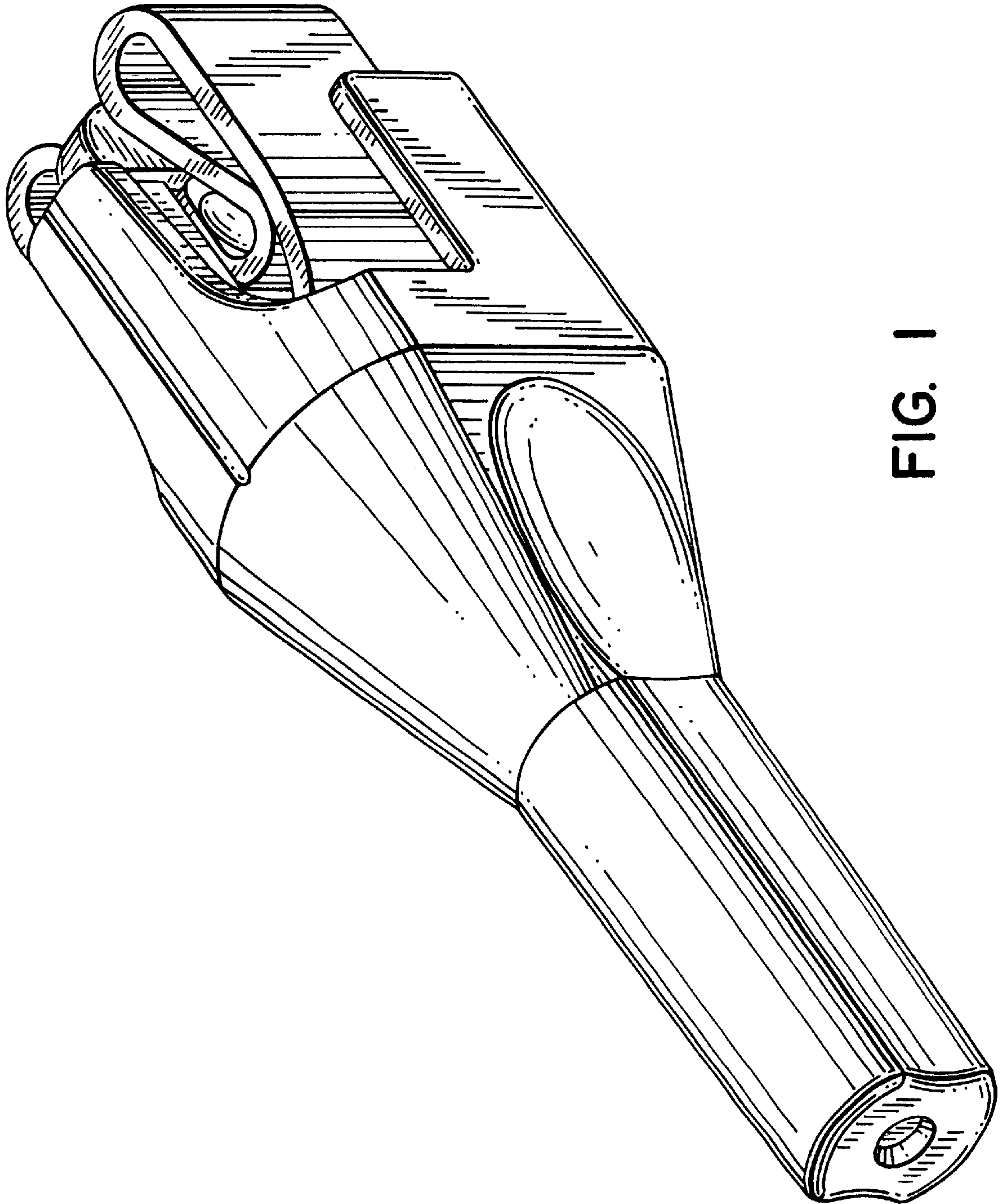

FIG. 1

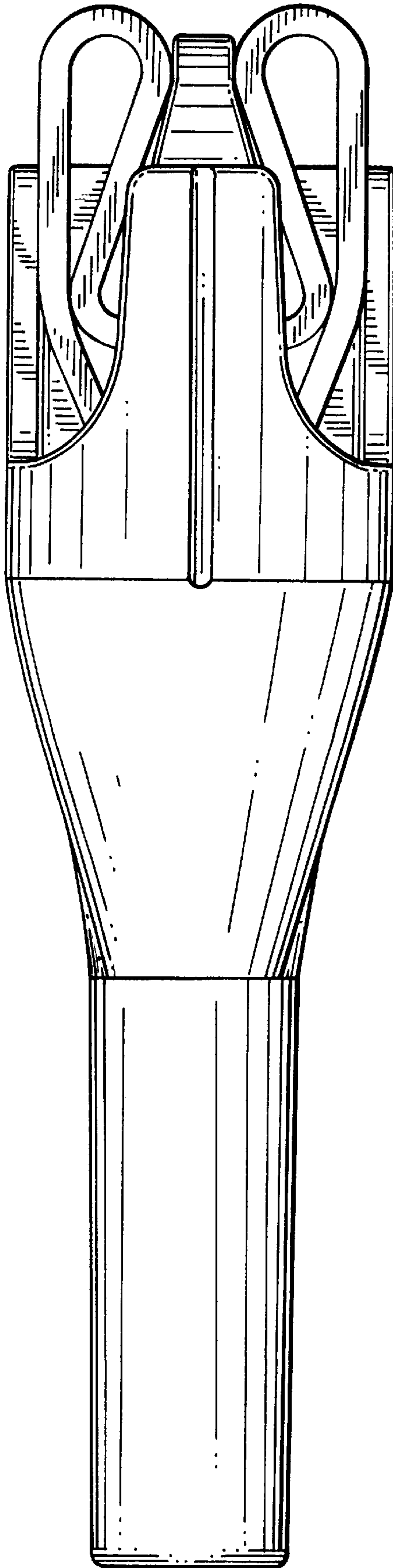
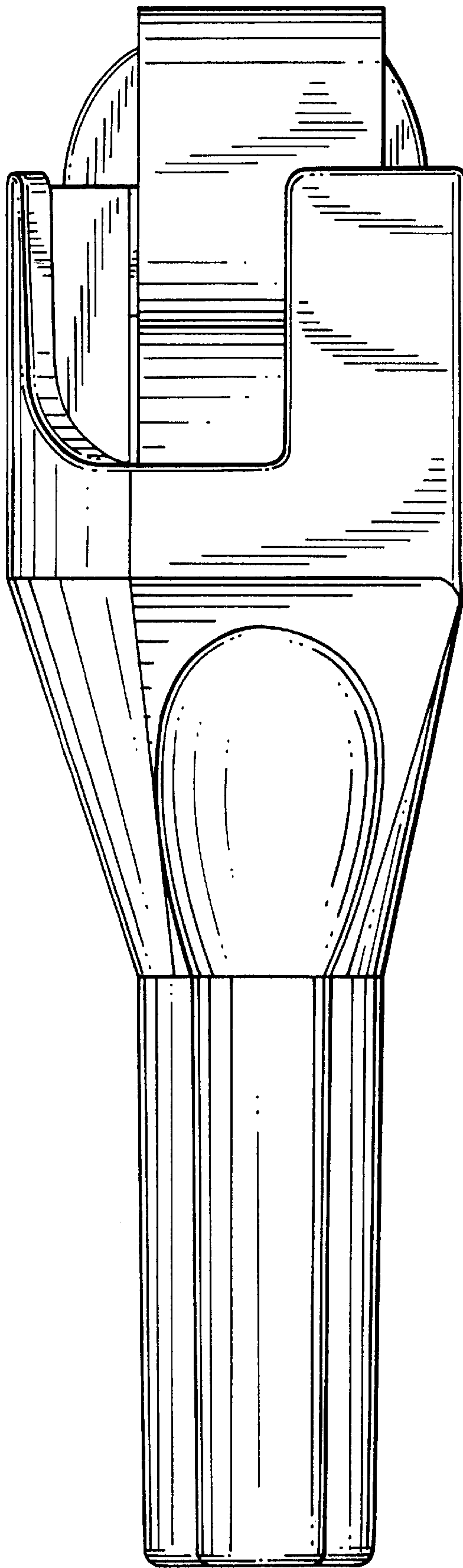

FIG. 2

FIG. 3





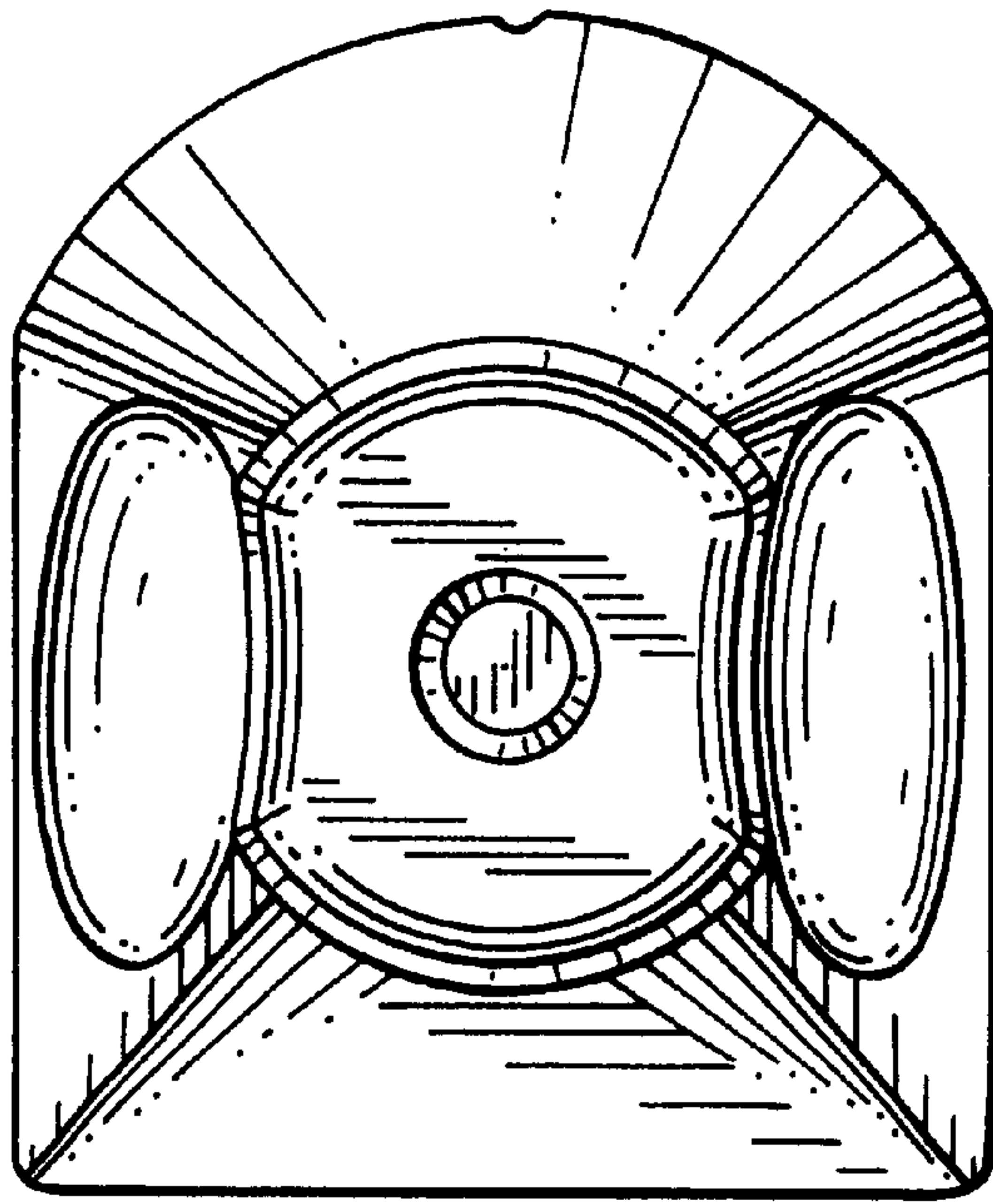

FIG. 4

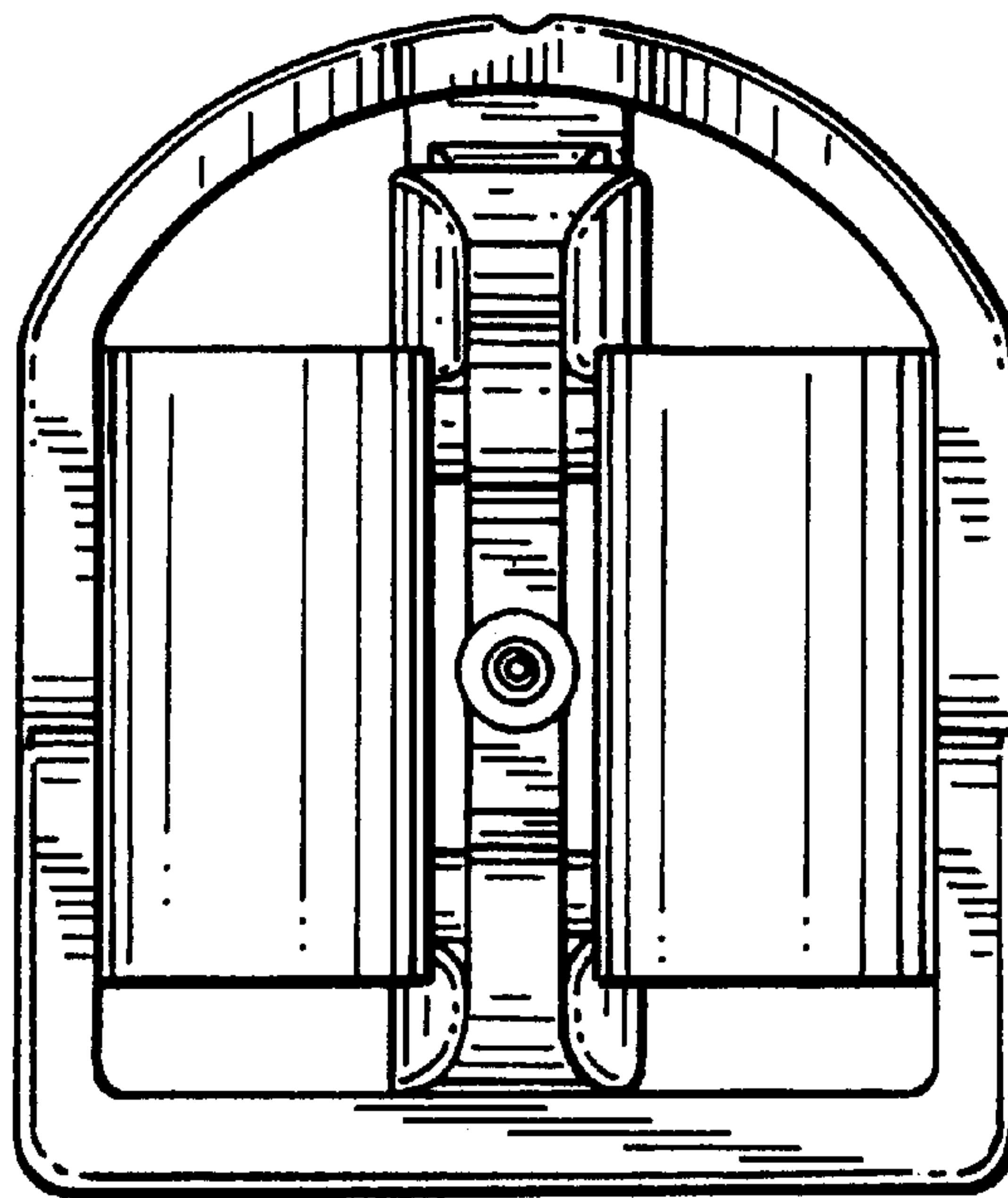

FIG. 5

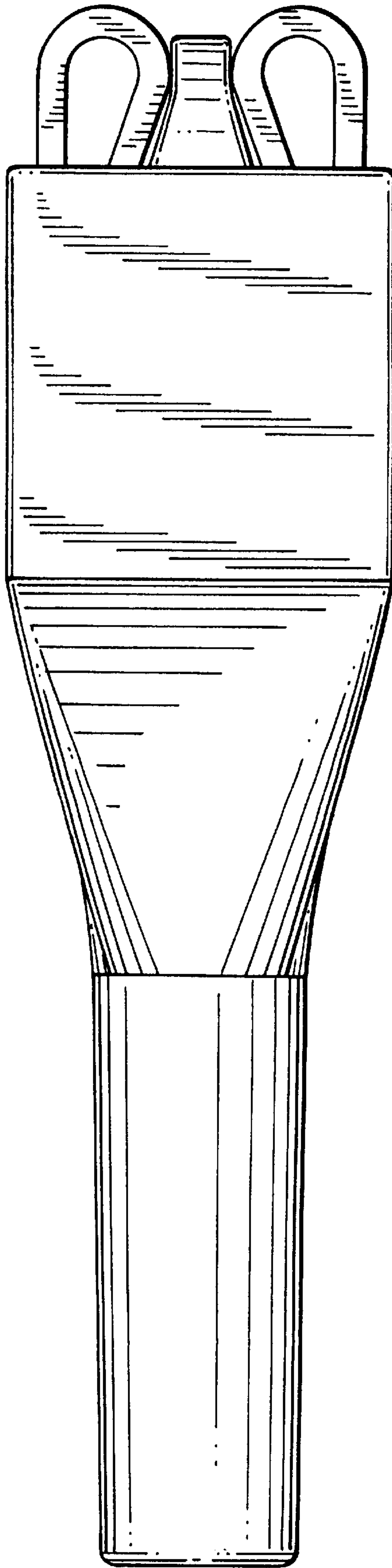

FIG. 6