

US00D451922B1

(12) **United States Design Patent**
Khovaylo et al.

(10) **Patent No.:** **US D451,922 S**

(45) **Date of Patent:** **** Dec. 11, 2001**

(54) **PORTION OF AN OPTICAL SCANNER**

(75) Inventors: **Modest Khovaylo**, Fort Collins, CO (US); **Scott Henderson**, Brooklyn, NY (US); **Steven Vordenberg**, New York, NY (US); **Arsenio Garcia-Monsalve**, Brooklyn, NY (US); **Kevin Lozeau**, Ridge, NY (US); **Davin Stowell**, New York, NY (US)

(73) Assignee: **Hewlett-Packard Company**, Palo Alto, CA (US)

(**) Term: **14 Years**

(21) Appl. No.: **29/143,111**

(22) Filed: **Jun. 7, 2001**

Related U.S. Application Data

(62) Division of application No. 29/126,556, filed on Jul. 19, 2000, now Pat. No. Des. 448,383.

(51) **LOC (7) Cl.** **14-02**

(52) **U.S. Cl.** **D14/425**

(58) **Field of Search** D14/421, 422, D14/424, 425; D18/36, 37, 39; 250/556; 355/64, 65, 75, 81; 235/454, 476, 482, 483, 441

(56) **References Cited**

U.S. PATENT DOCUMENTS

D. 380,742 * 7/1997 van de Loo D14/425

D. 388,773 * 1/1998 Chang et al. D14/425
D. 389,468 * 1/1998 Chang et al. D14/425
D. 394,047 * 5/1998 Chang et al. D14/425
D. 419,974 * 2/2000 Itakura D14/425

* cited by examiner

Primary Examiner—Freda Nunn

(57) **CLAIM**

The ornamental design for a portion of an optical scanner, as shown and described.

DESCRIPTION

FIG. 1 is an isometric view of a portion of an optical scanner showing our new design wherein the broken lines are shown for illustrative purposes only and form no part of the claimed design;

FIG. 2 is a top plan view thereof;

FIG. 3 is a bottom plan view thereof;

FIG. 4 is a front elevational view thereof;

FIG. 5 is a left side elevational view thereof;

FIG. 6 is a right side elevational view thereof; and,

FIG. 7 is an enlarged, partially cut away, left side elevational view thereof with a front left portion removed to more clearly show the front contour.

The rear view is unornamented and does not form any part of Applicants' claimed invention.

1 Claim, 6 Drawing Sheets

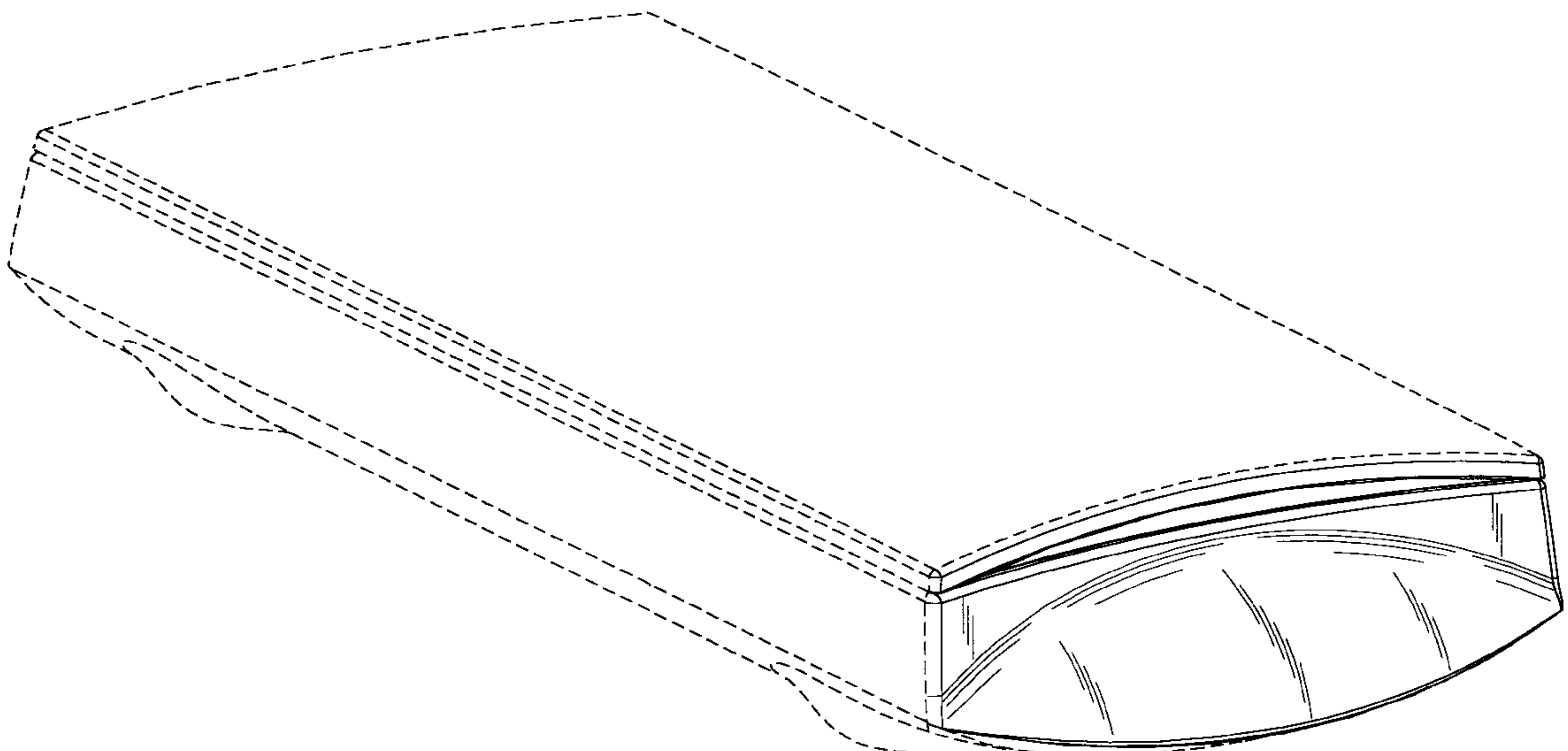

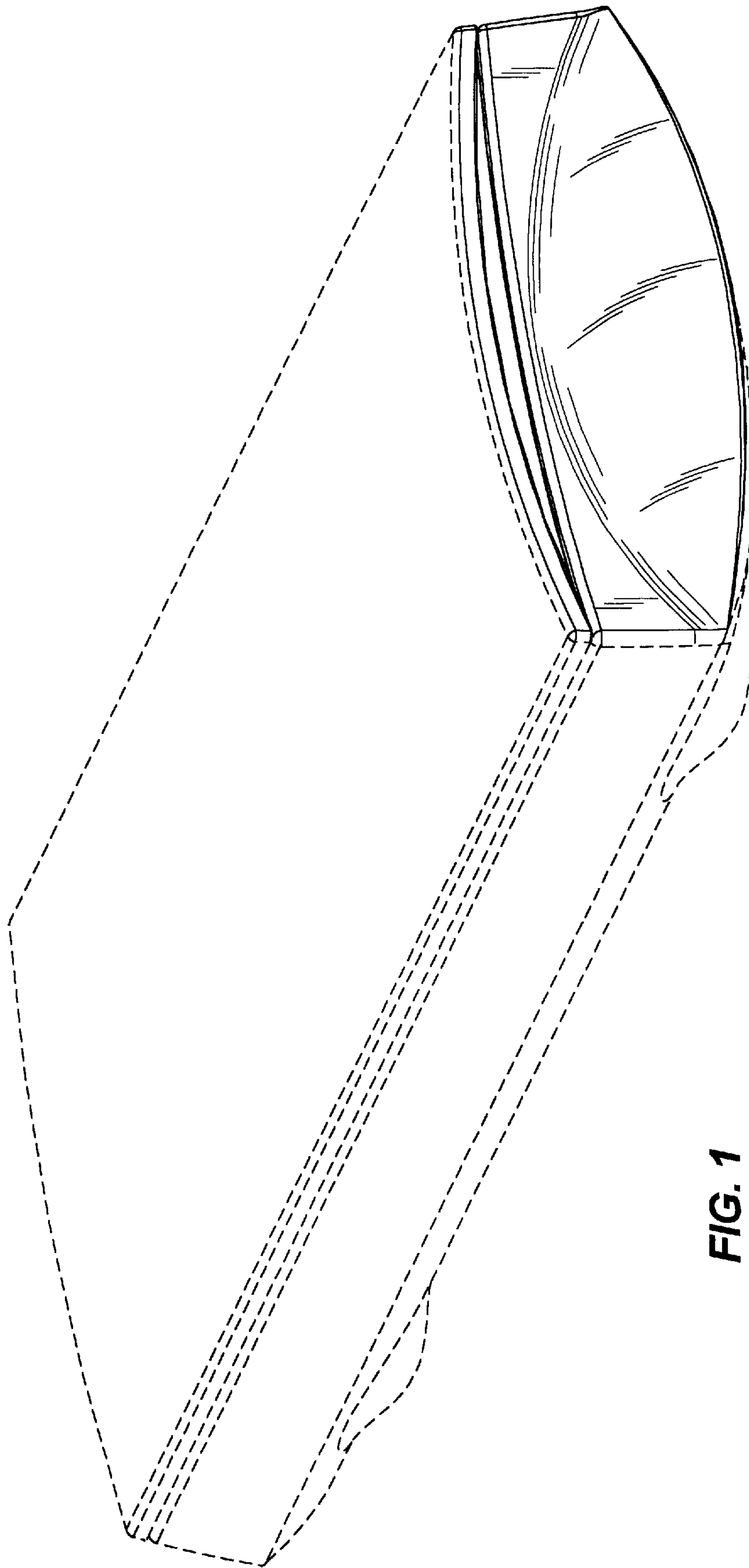

FIG. 1

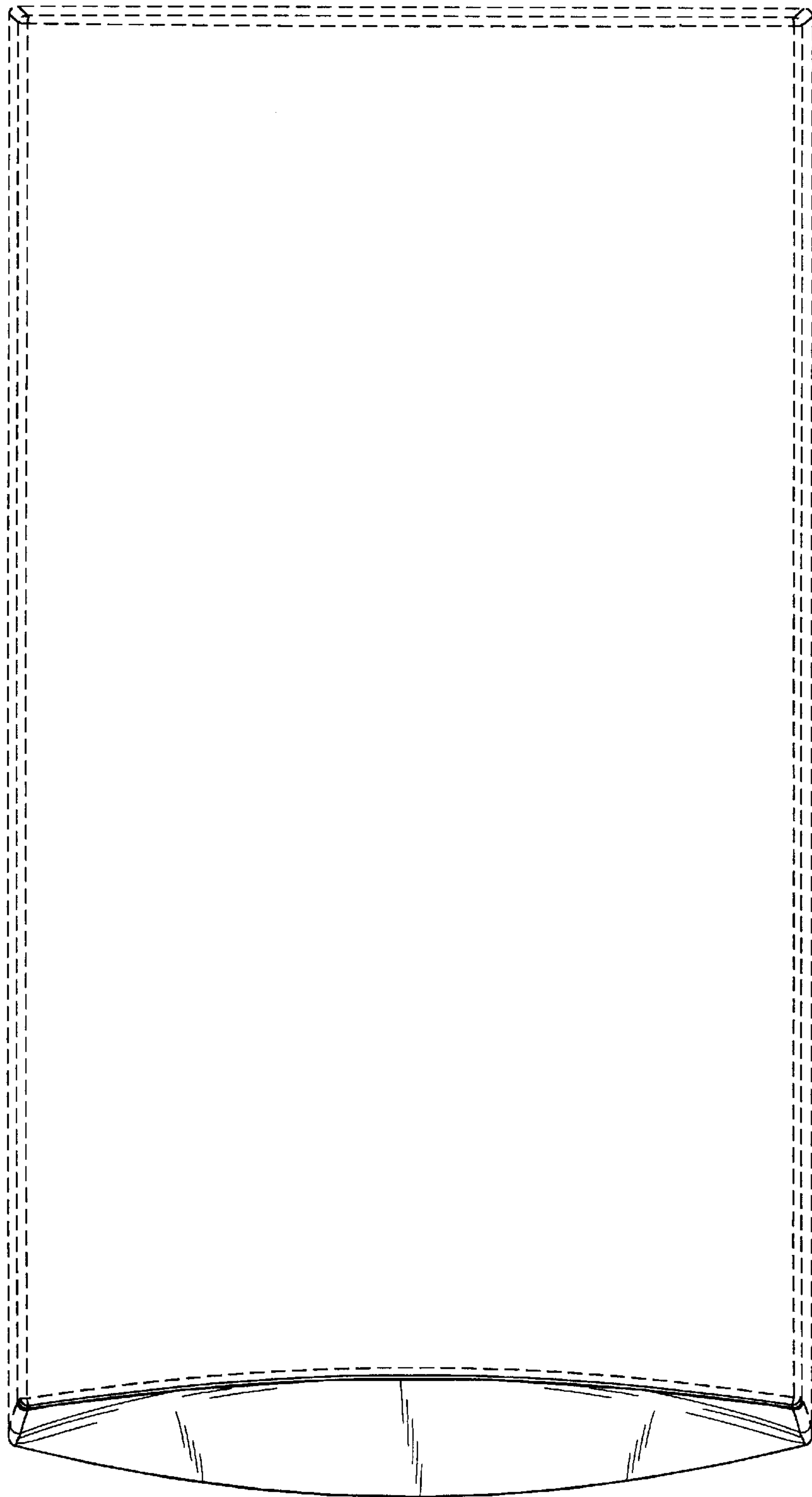

FIG. 2

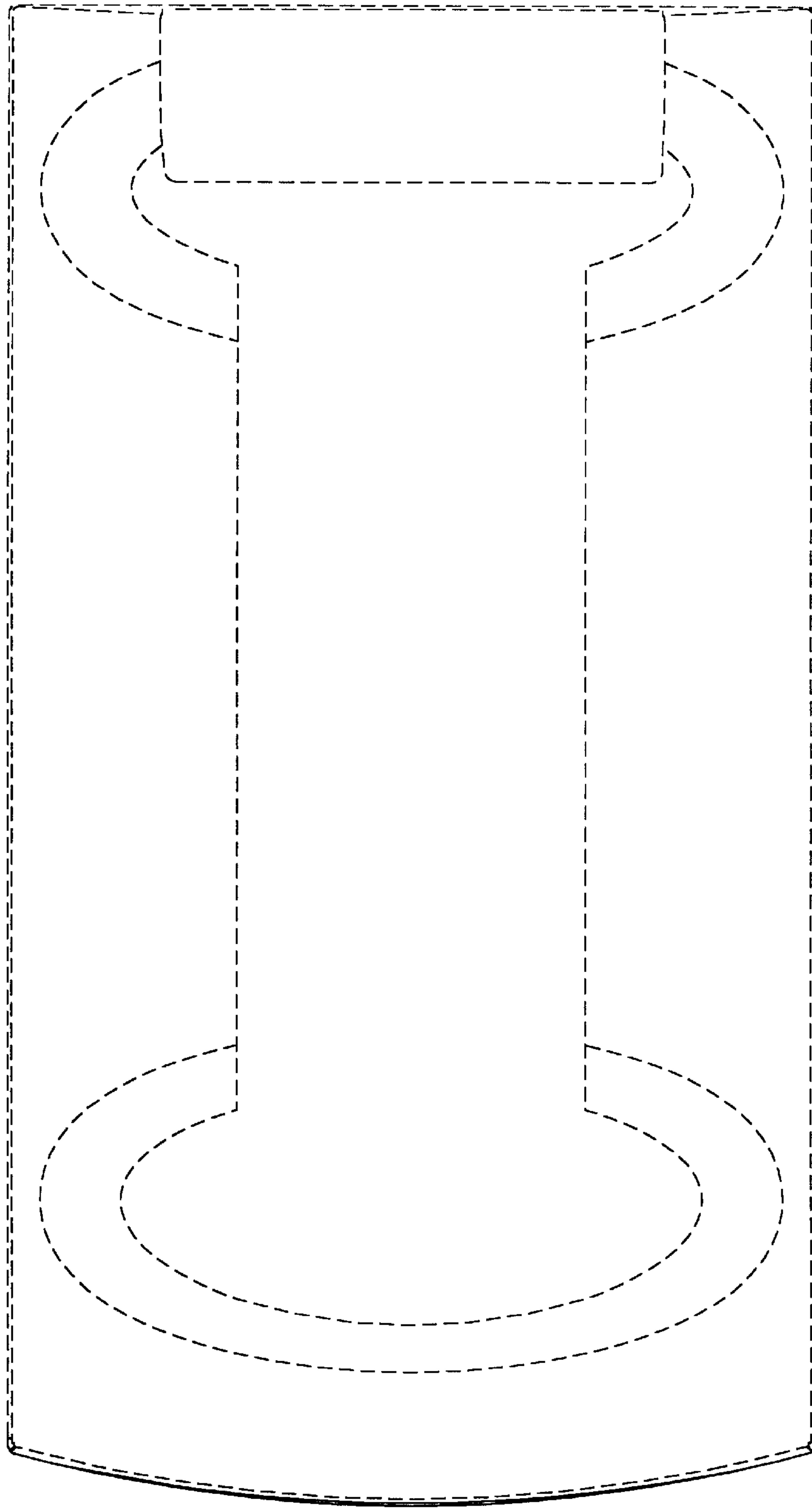

FIG. 3

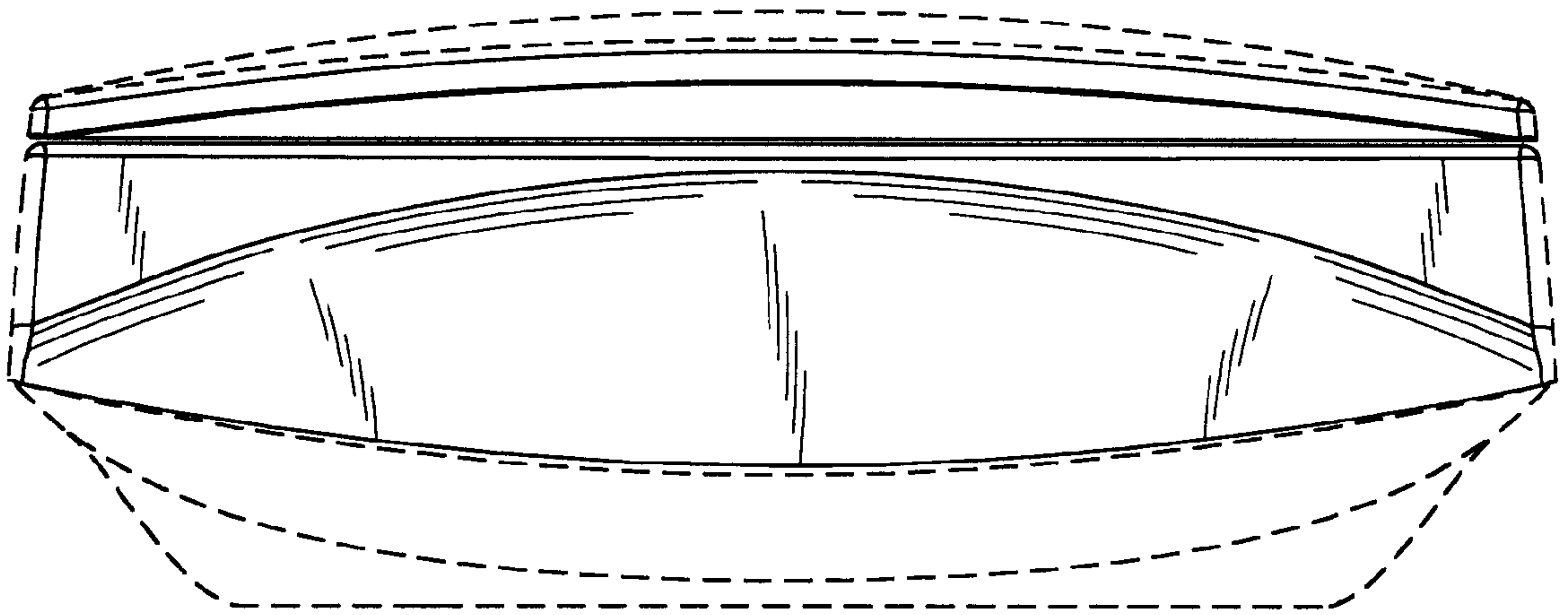

FIG. 4

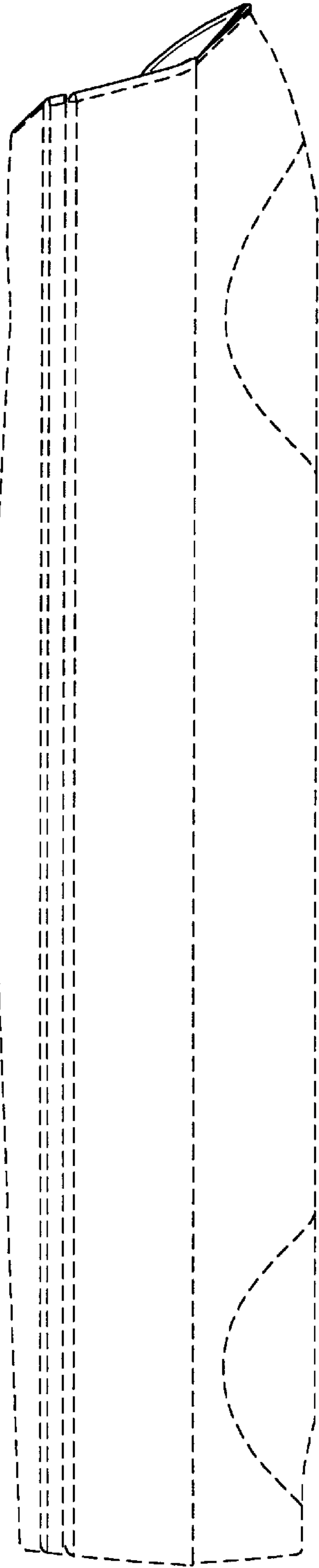

FIG. 5

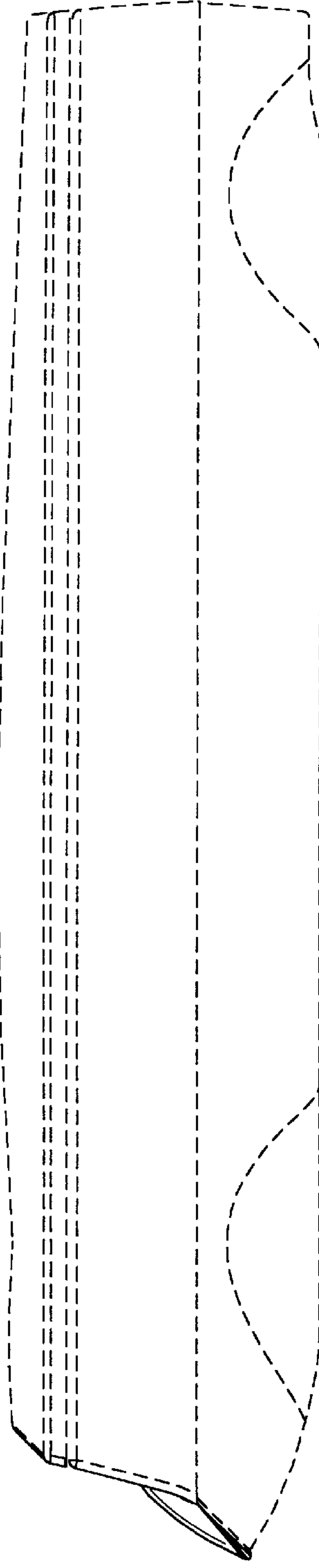

FIG. 6

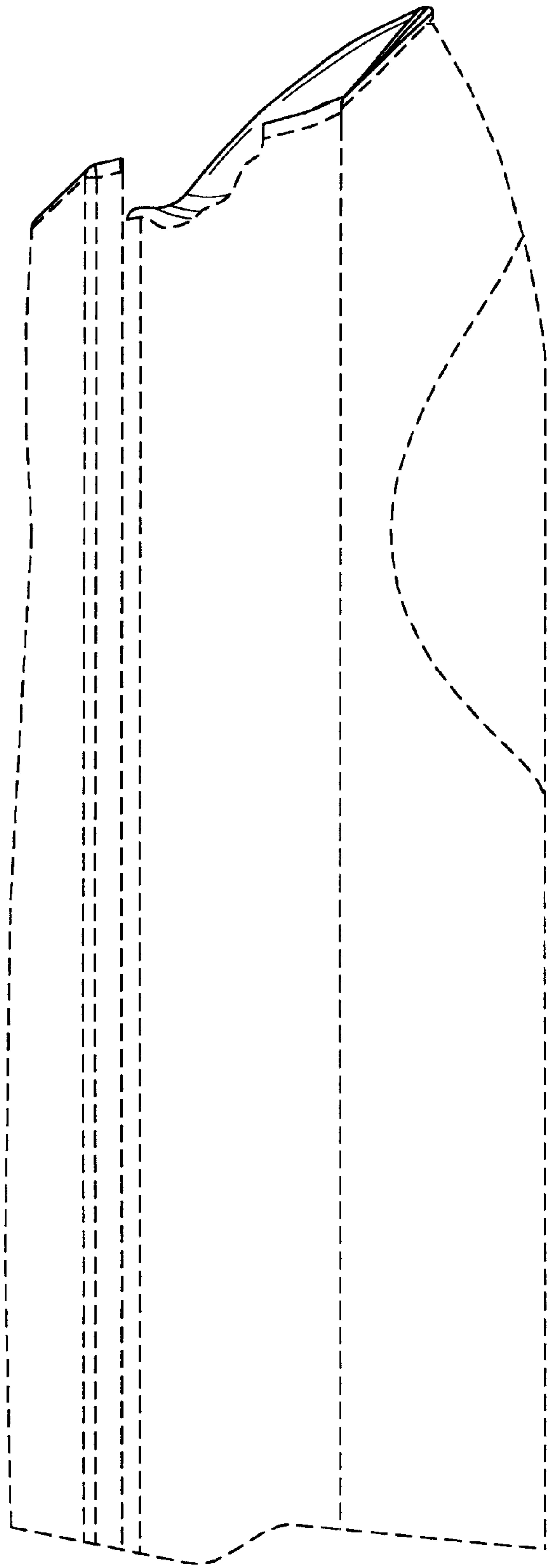

FIG. 7