



US00D451911B1

(12) **United States Design Patent**
Kubik

(10) **Patent No.:** **US D451,911 S**

(45) **Date of Patent:** **** Dec. 11, 2001**

(54) **RF WIRELESS MODEM**

(75) **Inventor:** **Randy James Kubik, Calgary (CA)**

(73) **Assignee:** **Novatel Wireless, Inc., San Diego, CA (US)**

(**) **Term:** **14 Years**

(21) **Appl. No.:** **29/133,103**

(22) **Filed:** **Nov. 21, 2000**

(51) **LOC (7) Cl.** **14-03**

(52) **U.S. Cl.** **D14/242**

(58) **Field of Search** D14/125, 257,
D14/140, 142, 299, 433, 434, 356-358,
435-438, 308, 349, 353, 240, 242, 155,
159, 141, 352, 439; 379/419, 420, 428,
440, 406, 93.01, 93.28; 455/550-575, 90;
D13/184; 361/600, 622, 724-728; 375/220-225;
D3/218

(56) **References Cited**

U.S. PATENT DOCUMENTS

D. 312,534	*	12/1990	Nelson et al.	D3/228
D. 354,951	*	1/1995	Fenton et al.	D14/242
D. 359,034	*	6/1995	Kondo	D14/434
D. 363,289	*	10/1995	Kobayashi et al.	D14/242
D. 368,911	*	4/1996	Lam	D14/242
D. 373,121	*	8/1996	Deluliis et al.	D14/457
D. 374,675	*	10/1996	Sakai et al.	D14/242
D. 380,205	*	6/1997	Bares	D14/242
D. 406,848	*	3/1999	Salmi	D14/240

D. 419,565	*	1/2000	Lohrding et al.	D14/230
D. 420,671	*	2/2000	Jacobsen et al.	D14/240
D. 421,424	*	3/2000	Lee et al.	D14/434
D. 423,473	*	4/2000	Iwamoto	D14/434
D. 424,035	*	5/2000	Steiner et al.	D14/439
D. 426,549	*	6/2000	Carlson	D14/433
D. 427,587	*	7/2000	Jacobsen et al.	D14/240
D. 431,250	*	9/2000	Richter	D14/447
D. 443,247	*	6/2001	Chuan et al.	D13/107
5,535,274	*	7/1996	Braitberg et al.	379/446
5,739,665	*	4/1998	Bares	320/115
6,073,034	*	6/2000	Jacobsen et al.	455/566
6,176,401	*	1/2001	Lim	224/196

* cited by examiner

Primary Examiner—Jeffrey Asch

(74) *Attorney, Agent, or Firm*—Coudert Brothers LLP

(57) **CLAIM**

The ornamental design for an RF wireless modem, as shown and described.

DESCRIPTION

FIG. 1 is a front perspective view of an RF wireless modem according to the present invention;
FIG. 2 is a front view of an RF wireless modem according to the present invention;
FIG. 3 is a back view thereof;
FIG. 4 is a top view thereof;
FIG. 5 is a bottom view thereof;
FIG. 6 is a right side view thereof; and,
FIG. 7 is a left side view thereof.

1 Claim, 3 Drawing Sheets

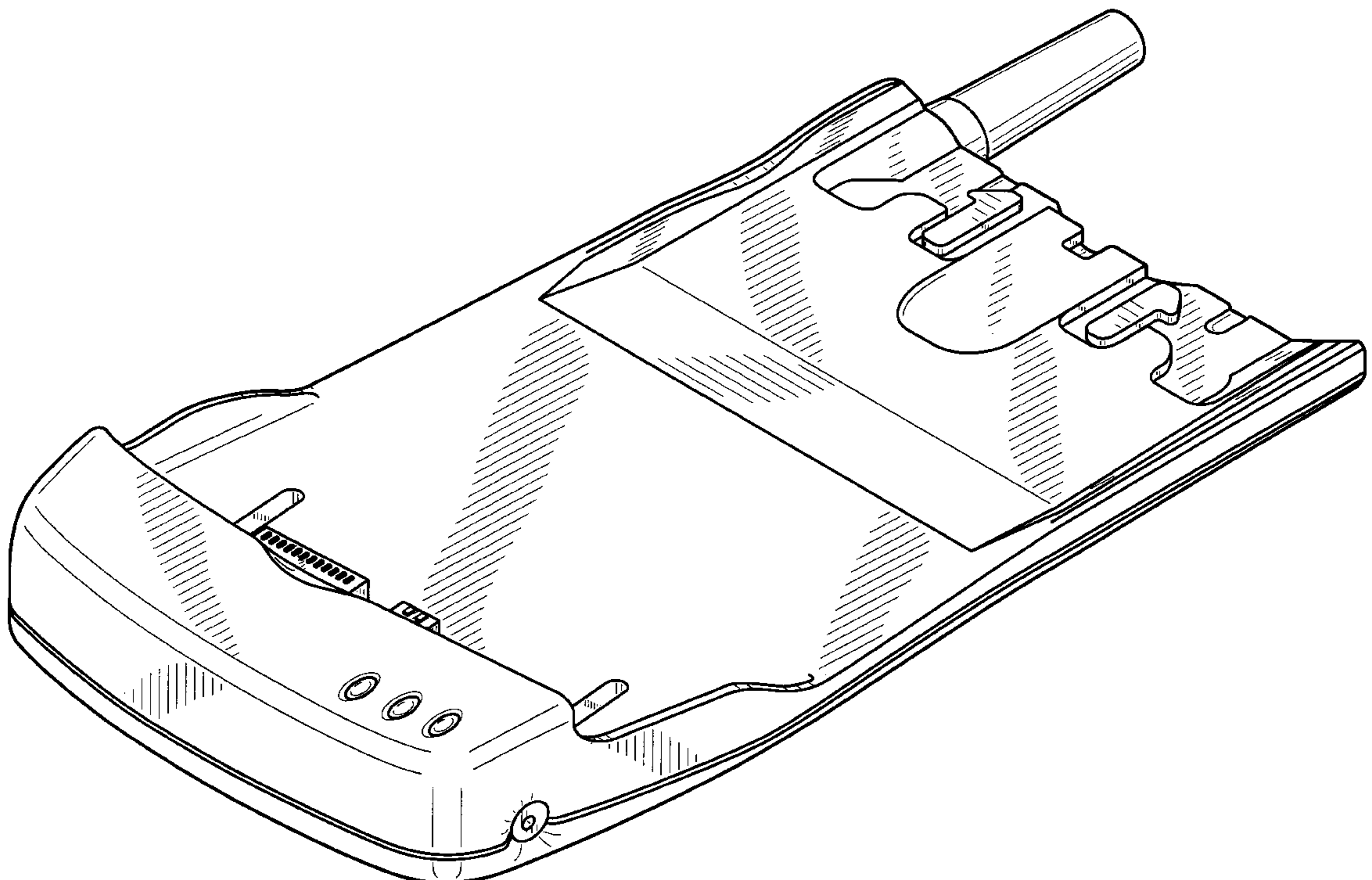

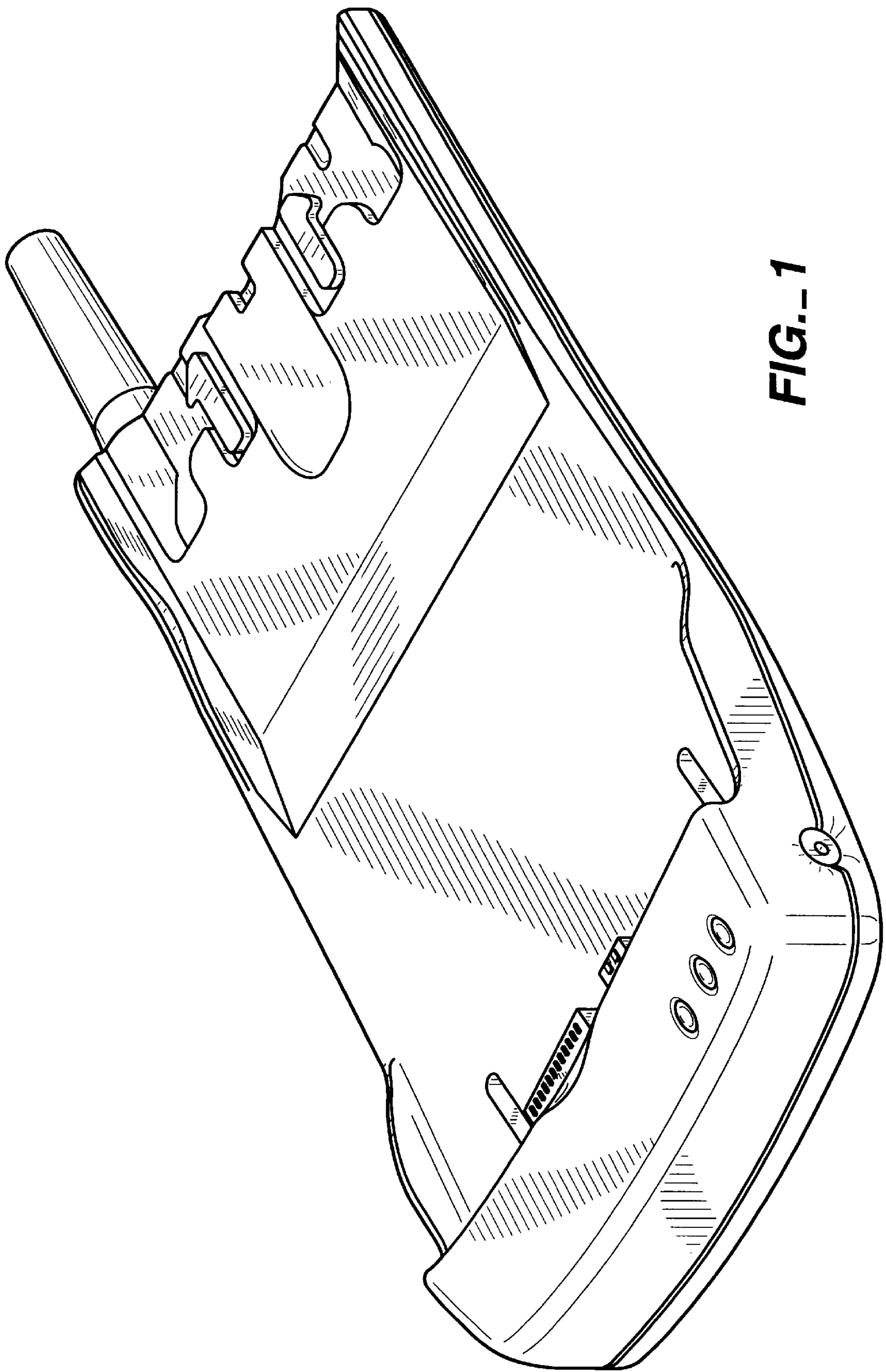

FIG.- 1

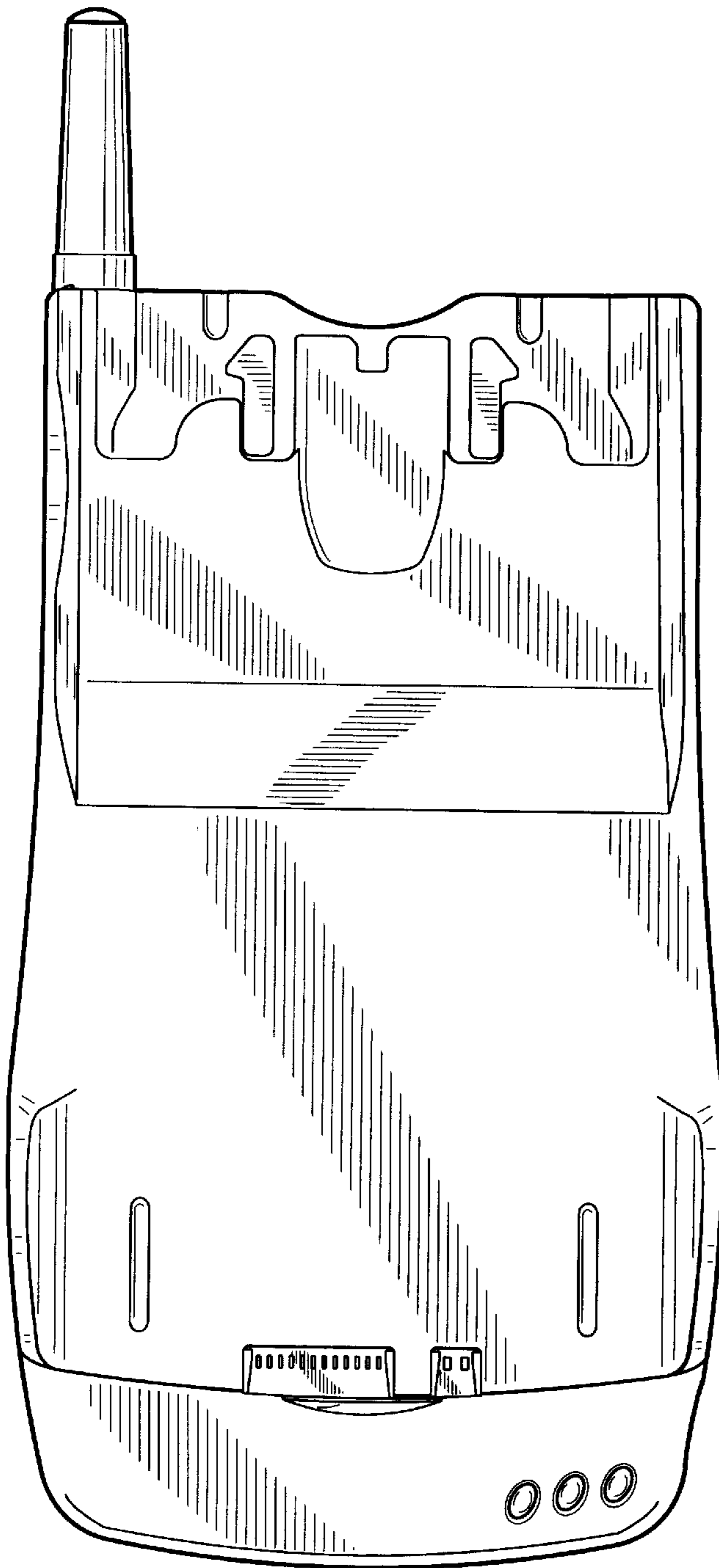

FIG._2

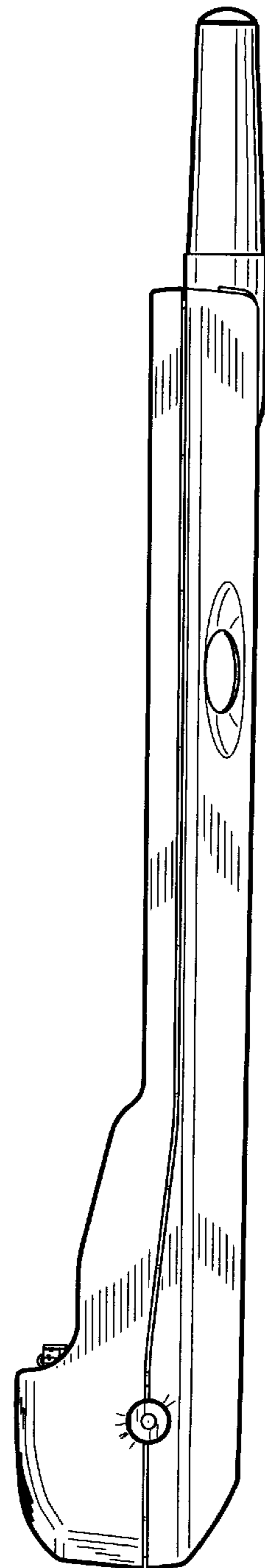

FIG._6

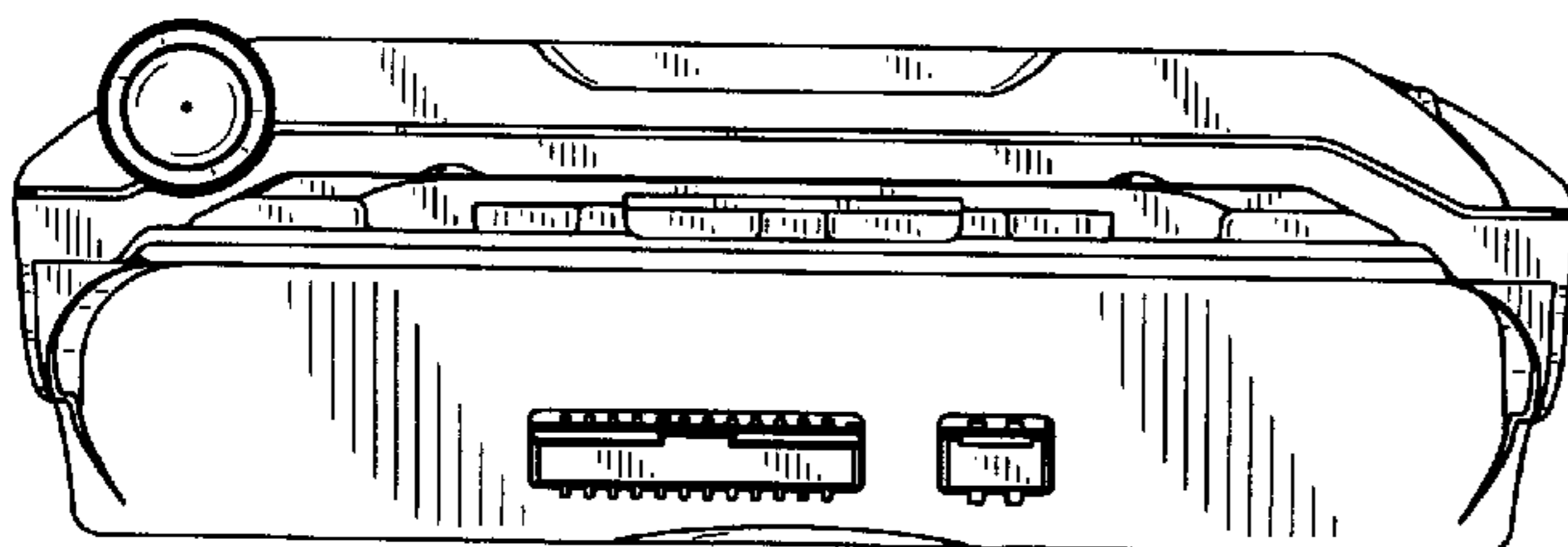

FIG._4

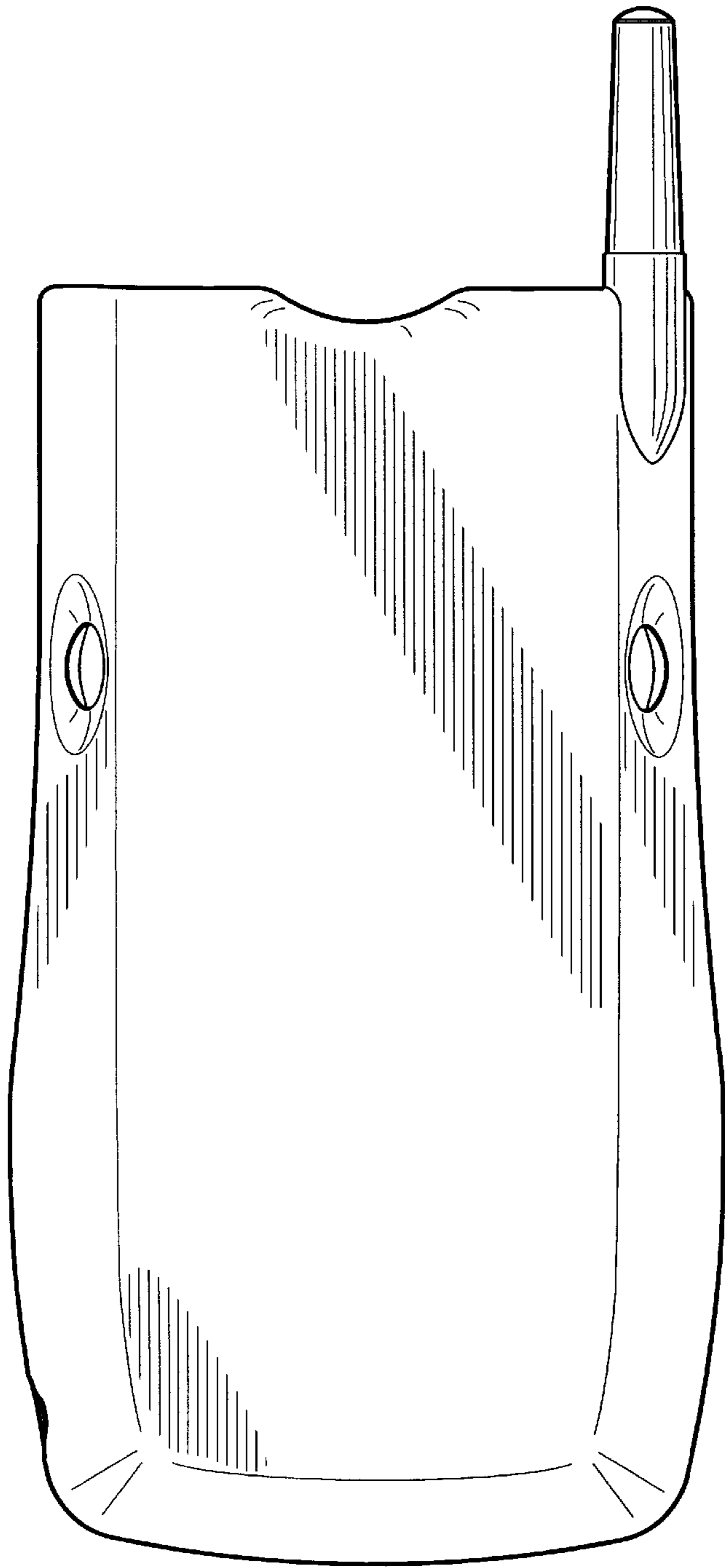

FIG._3

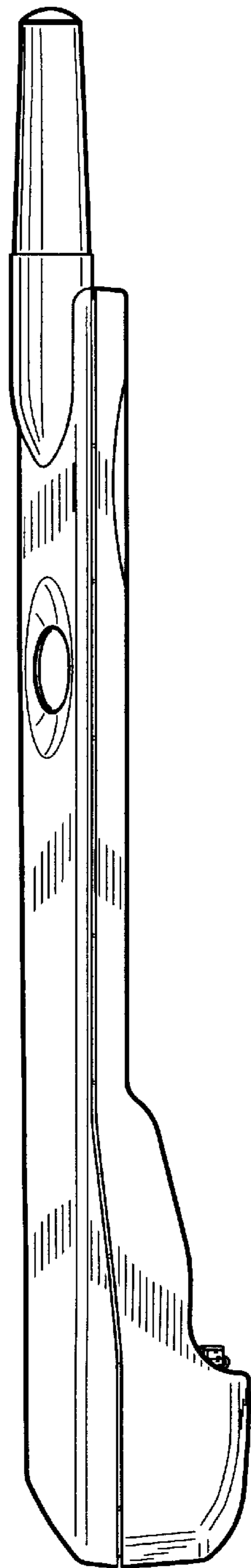

FIG._7

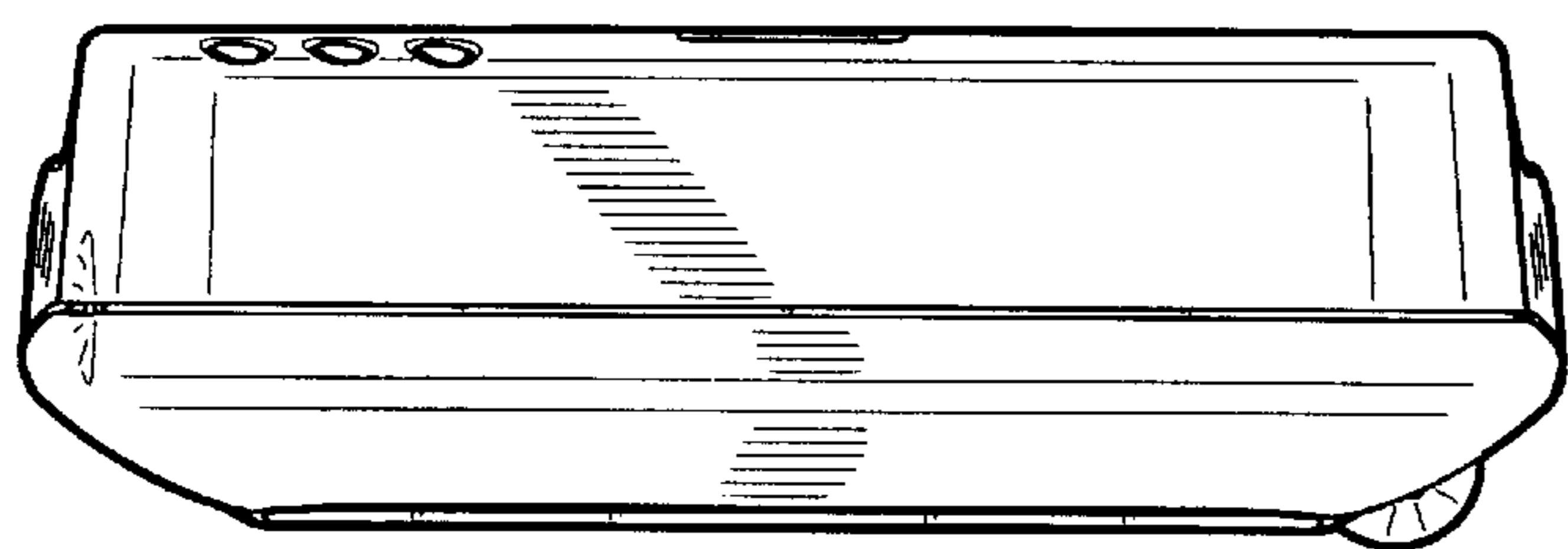

FIG._5