



US00D451817B1

(12) **United States Design Patent**  
**Zeller**

(10) **Patent No.:** **US D451,817 S**

(45) **Date of Patent:** **\*\* Dec. 11, 2001**

(54) **TRAVEL ALARM**

(76) **Inventor:** **Noel E. Zeller**, c/o Zelco Industries, Inc., 65 Haven Ave., Mount Vernon, NY (US) 10553-4445

(\*\*) **Term:** **14 Years**

(21) **Appl. No.:** **29/128,192**

(22) **Filed:** **Aug. 18, 2000**

(51) **LOC (7) Cl.** ..... **10-01**

(52) **U.S. Cl.** ..... **D10/18; D10/22**

(58) **Field of Search** ..... D10/1, 2, 3-15, D10/16-18, 19-40, 122-132; 368/10, 276, 277, 285, 316, 317

(56) **References Cited**

**U.S. PATENT DOCUMENTS**

- D. 313,118 \* 12/1990 Maddocks ..... D10/2 X
- D. 322,404 \* 12/1991 Phillips ..... D10/1
- D. 361,519 \* 8/1995 Inora ..... D10/18
- D. 397,618 \* 9/1998 Scott et al. .... D10/6
- D. 418,426 \* 1/2000 Gruosi ..... D10/7

\* cited by examiner

*Primary Examiner*—Martie K. Holtje

(74) *Attorney, Agent, or Firm*—Cooper & Dunham LLP; Donald S. Dowden

(57) **CLAIM**

The ornamental design for a travel alarm, as shown and described.

**DESCRIPTION**

FIG. 1 is a top view of a travel alarm in a first configuration showing my new design;  
 FIG. 2 is a left side view thereof;  
 FIG. 3 is a front view thereof;  
 FIG. 4 is a right side view thereof;  
 FIG. 5 is a bottom view thereof;  
 FIG. 6 is a rear view thereof;  
 FIG. 7 is a top view thereof in a second configuration;  
 FIG. 8 is a front view thereof;  
 FIG. 9 is a left side view thereof;  
 FIG. 10 is a right side view thereof;  
 FIG. 11 is a bottom view thereof;  
 FIG. 12 is a rear view thereof;  
 FIG. 13 is a top view thereof in a third configuration;  
 FIG. 14 is a front view thereof;  
 FIG. 15 is a top view thereof in a fourth configuration;  
 FIG. 16 is a front view thereof;  
 FIG. 17 is a left side view thereof;  
 FIG. 18 is a right side view thereof;  
 FIG. 19 is a bottom view thereof; and,  
 FIG. 20 is a rear view thereof.

**1 Claim, 6 Drawing Sheets**

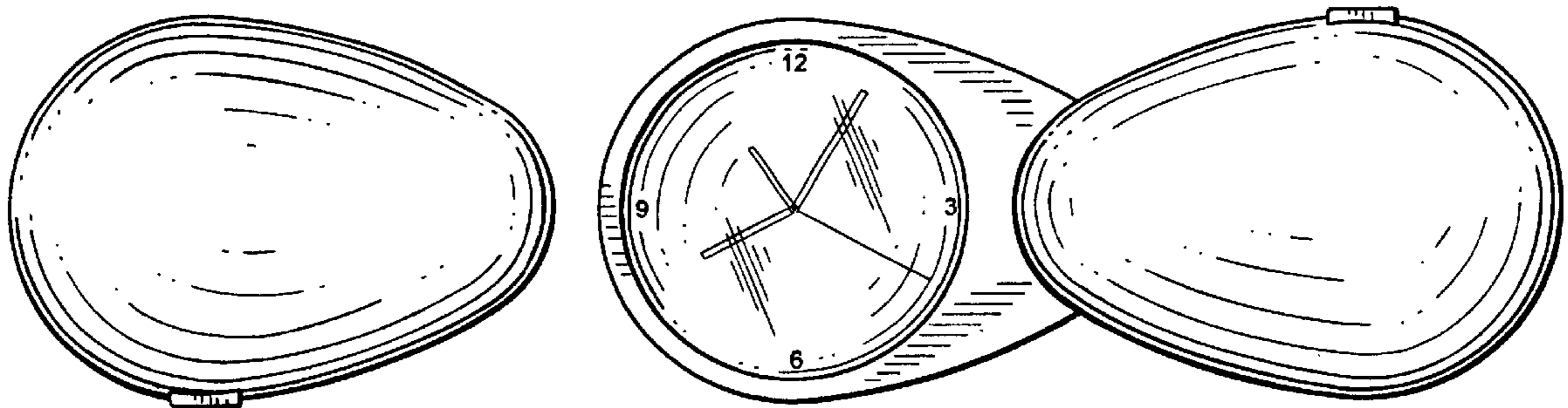

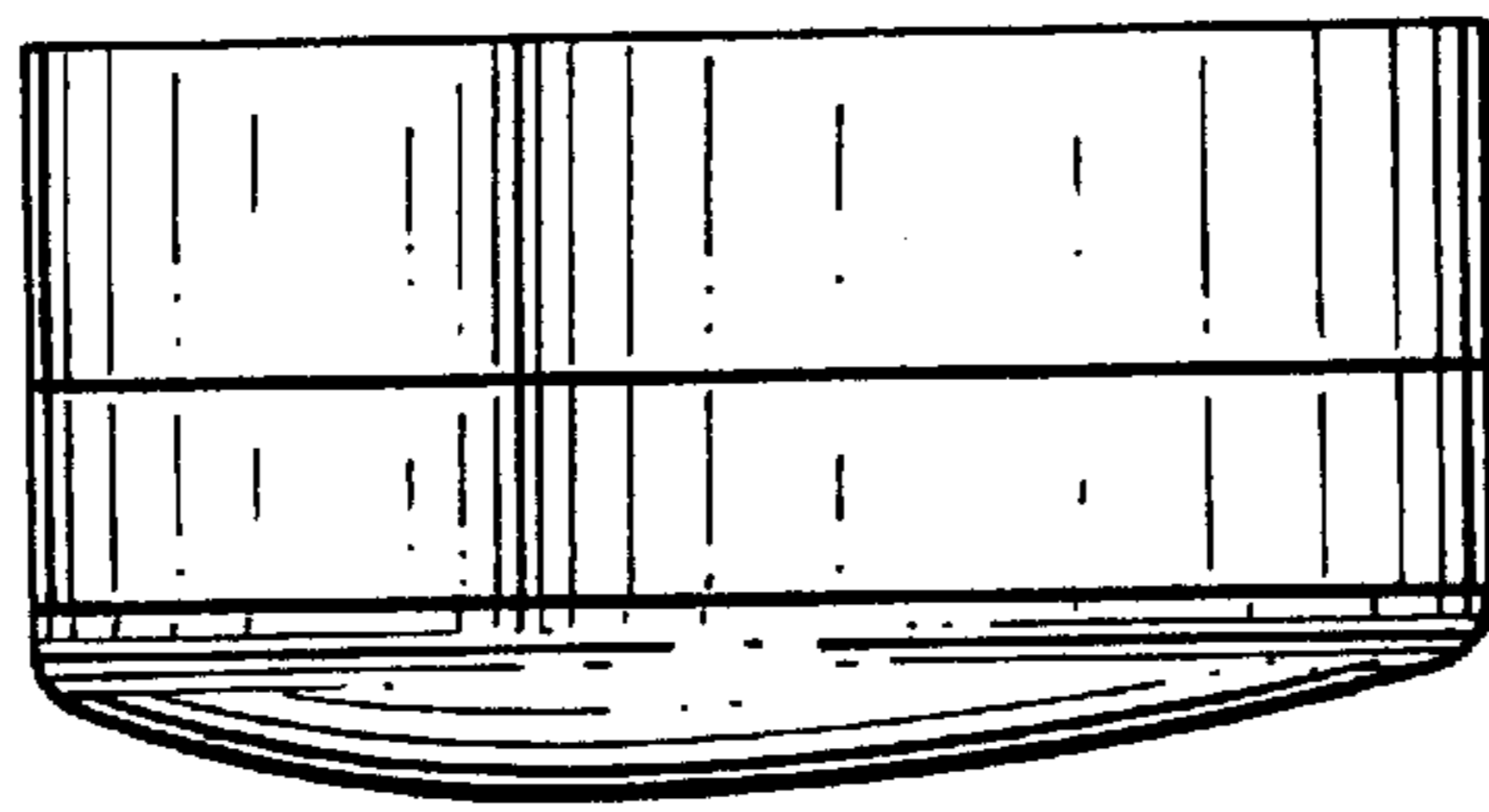

FIG. 1

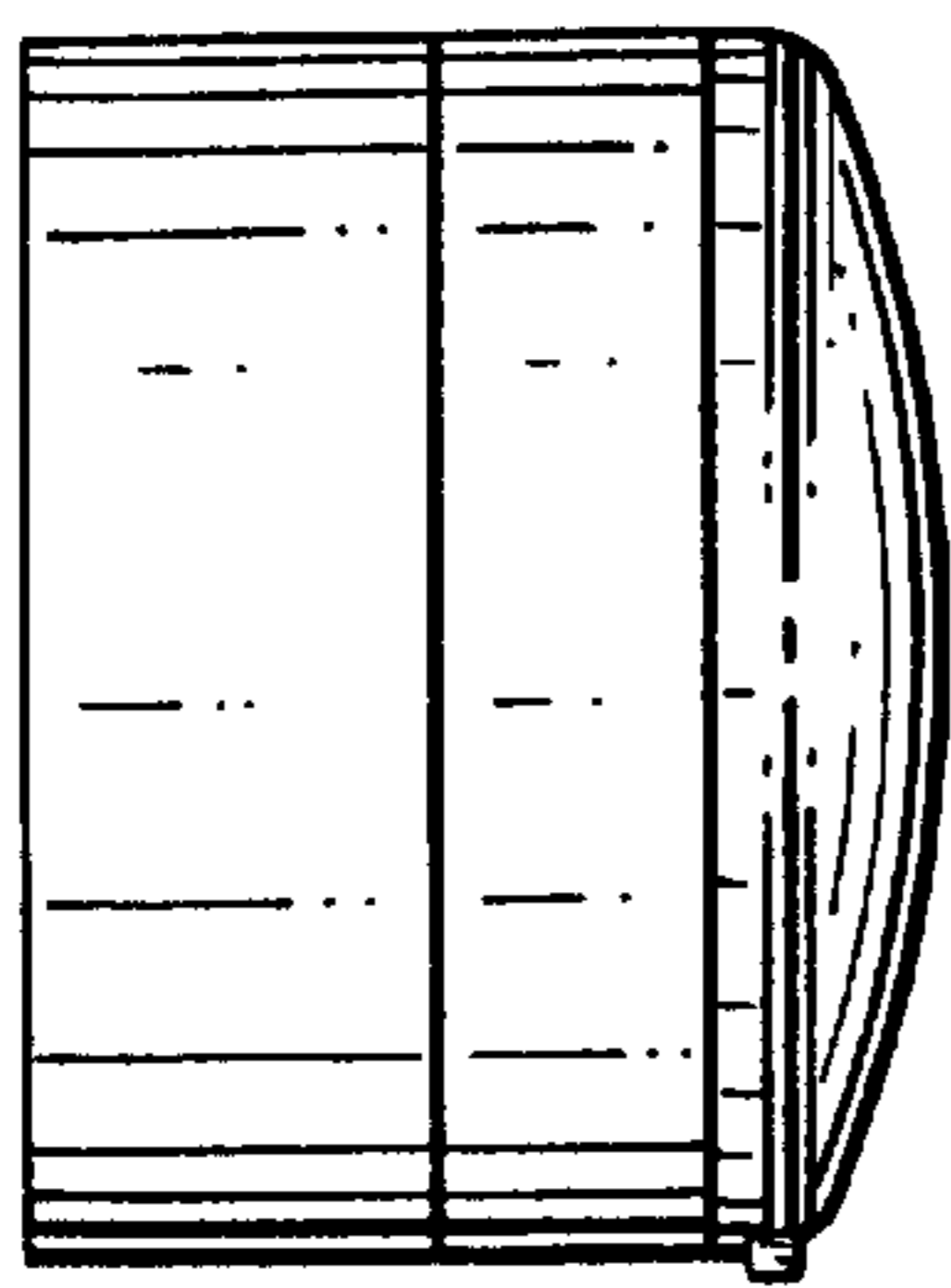

FIG. 2

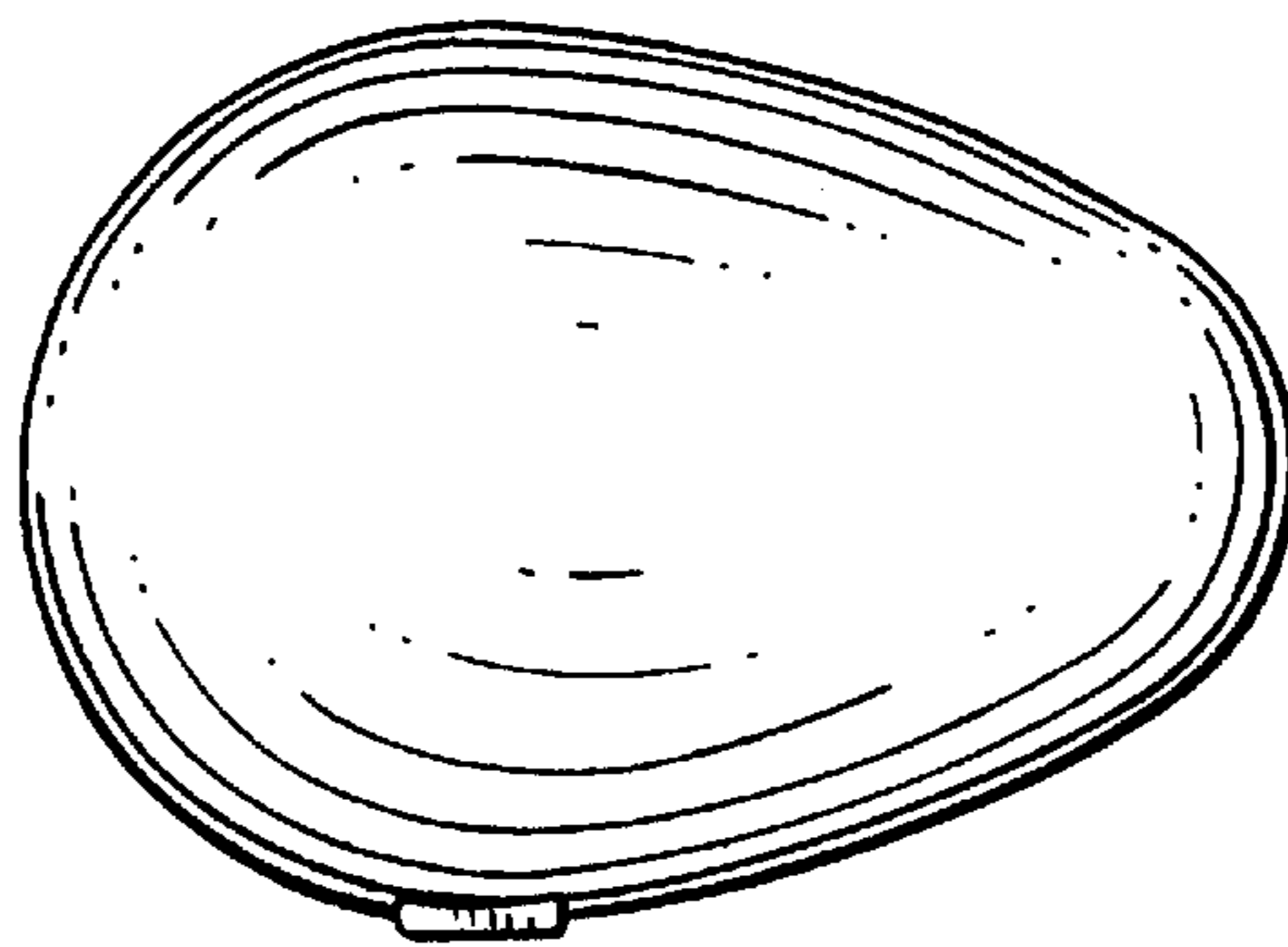

FIG. 3

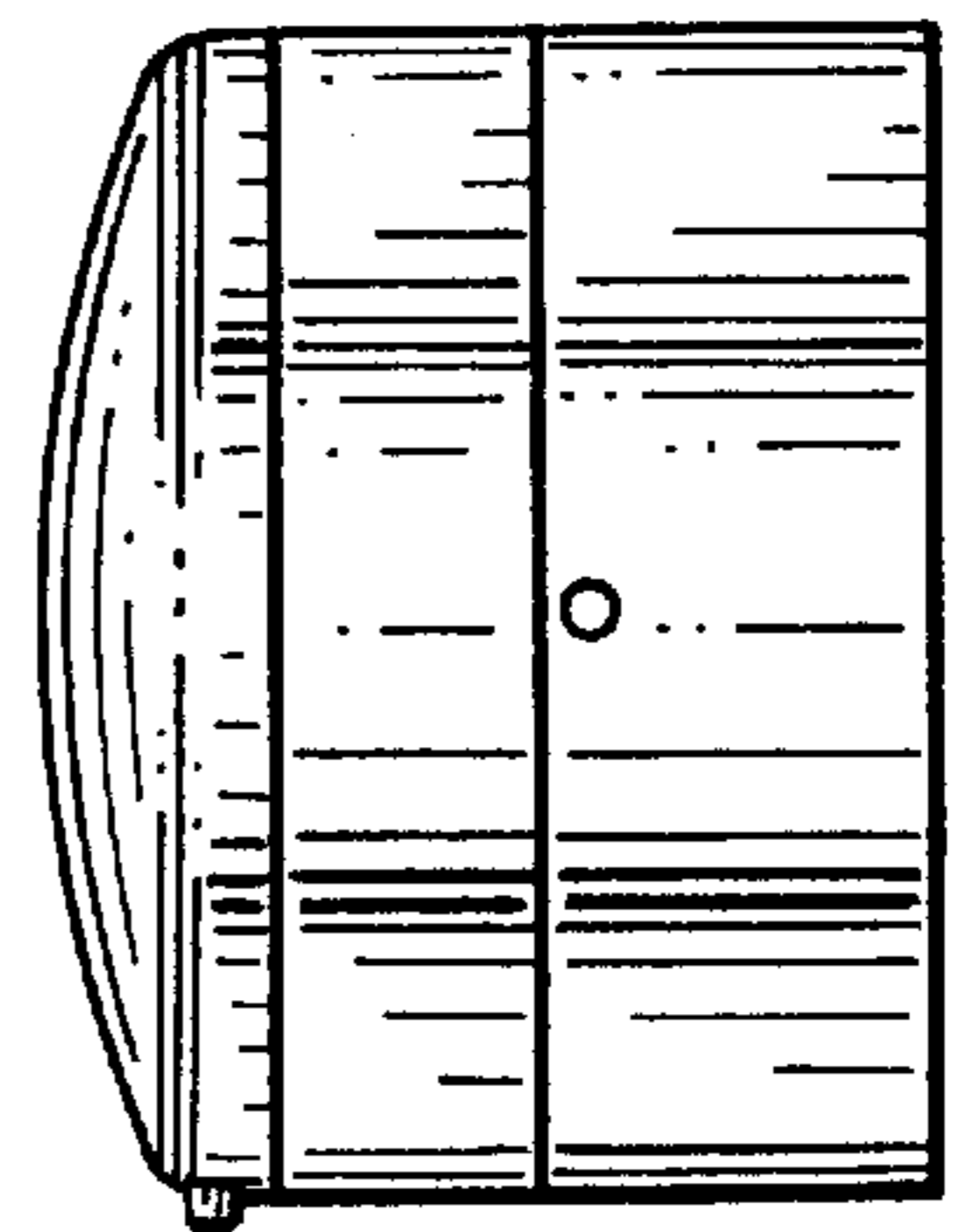

FIG. 4

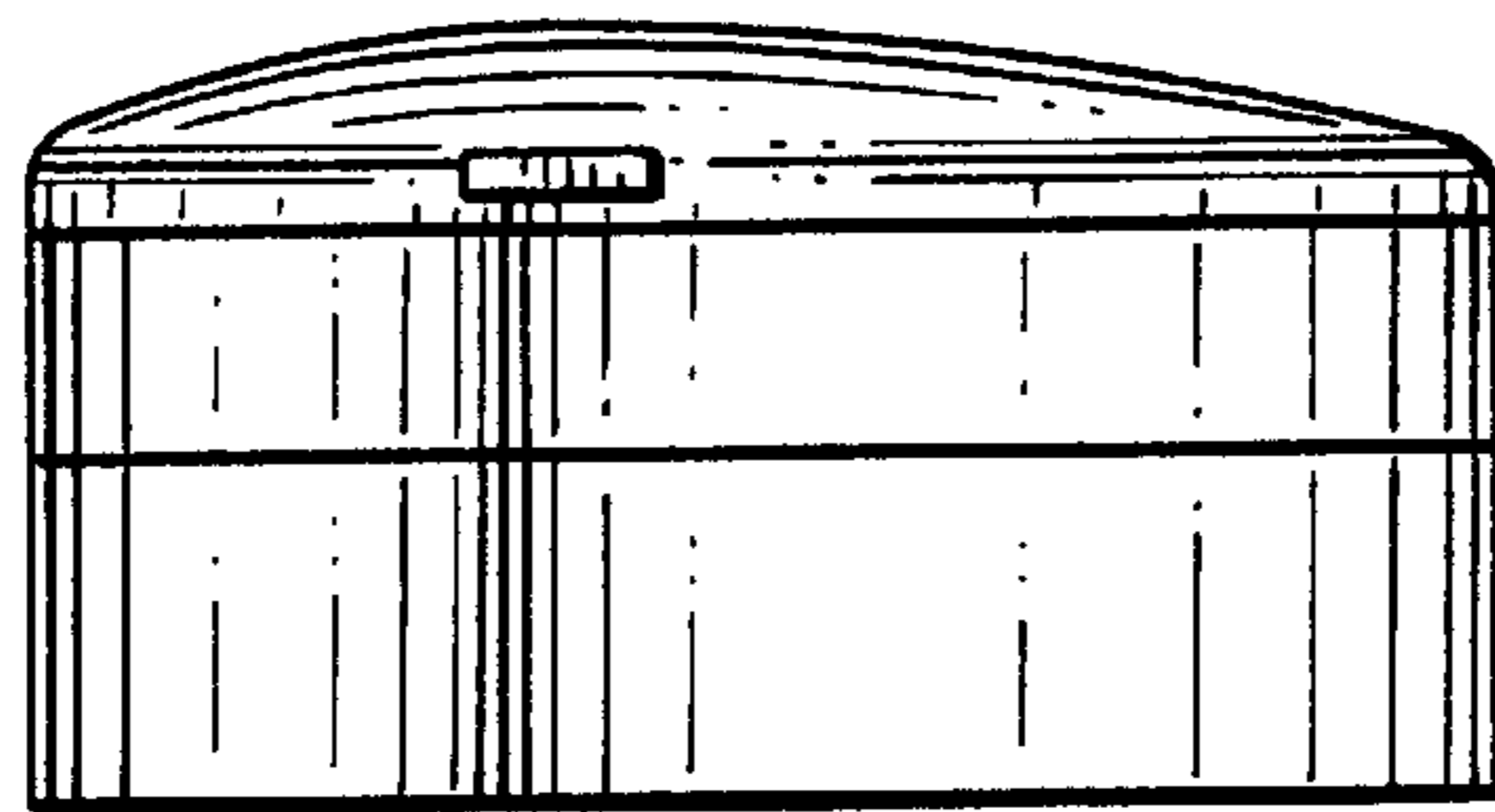

FIG. 5

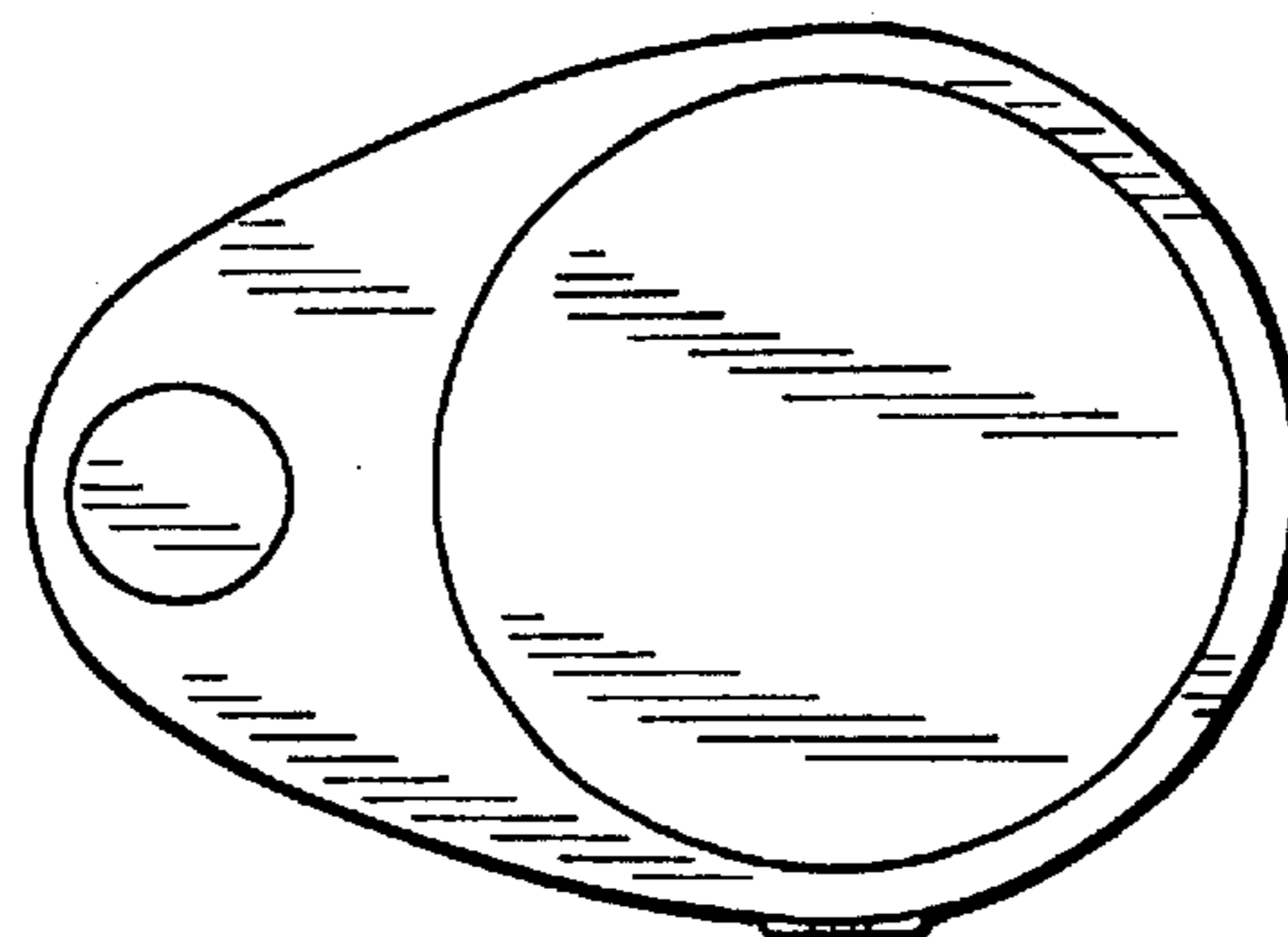

FIG. 6

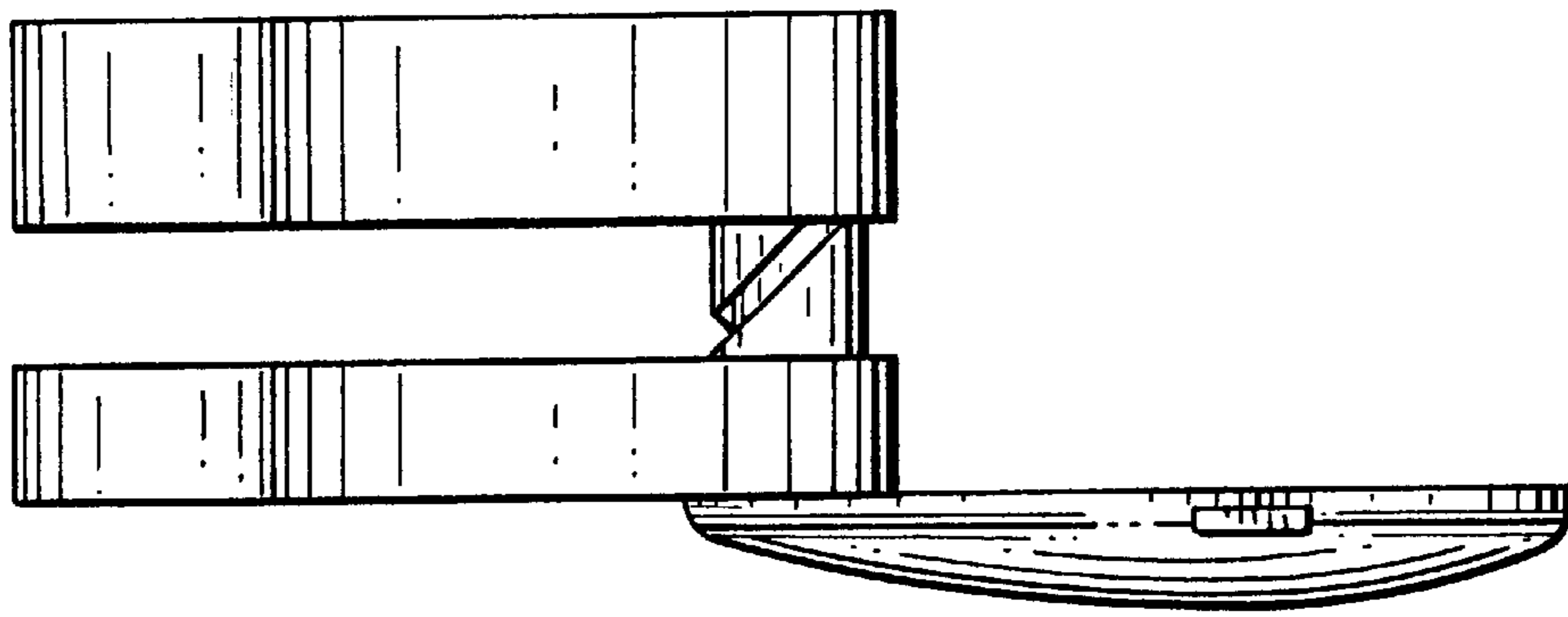

FIG. 7

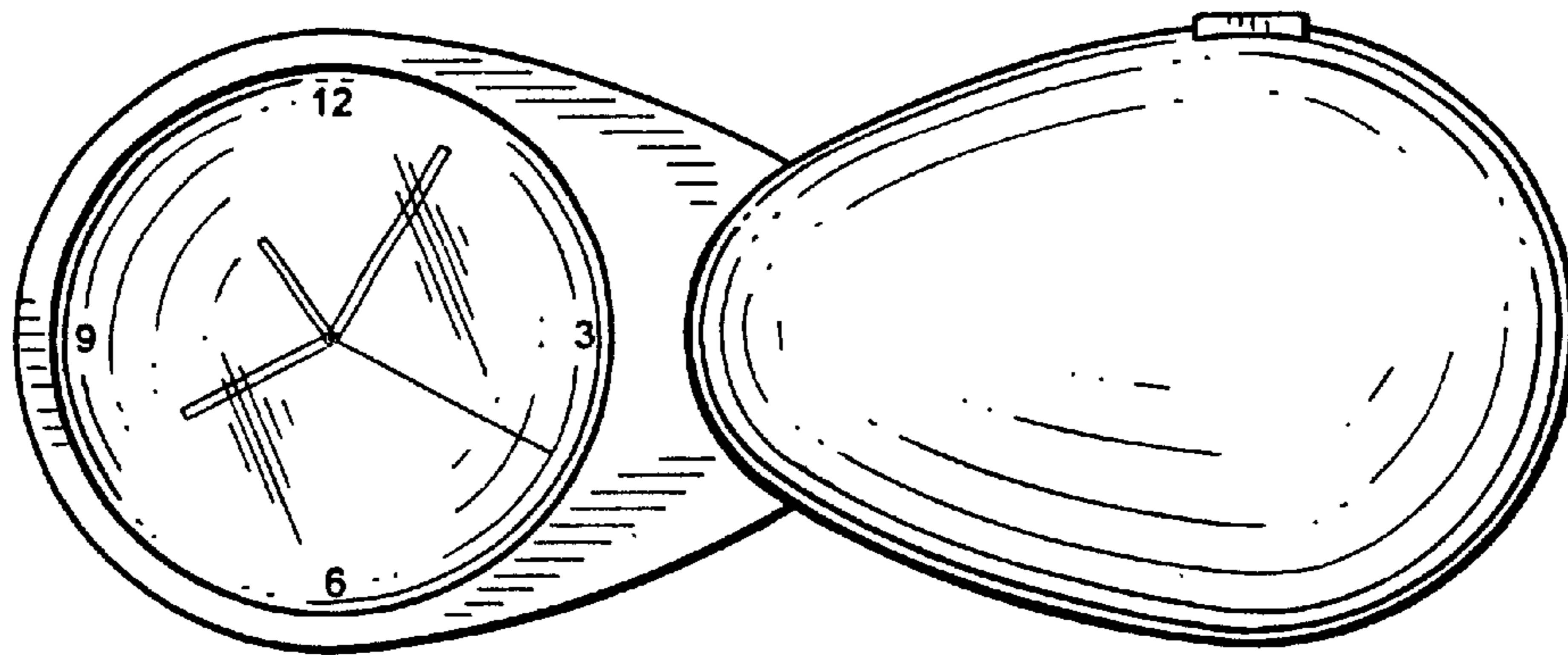

FIG. 8

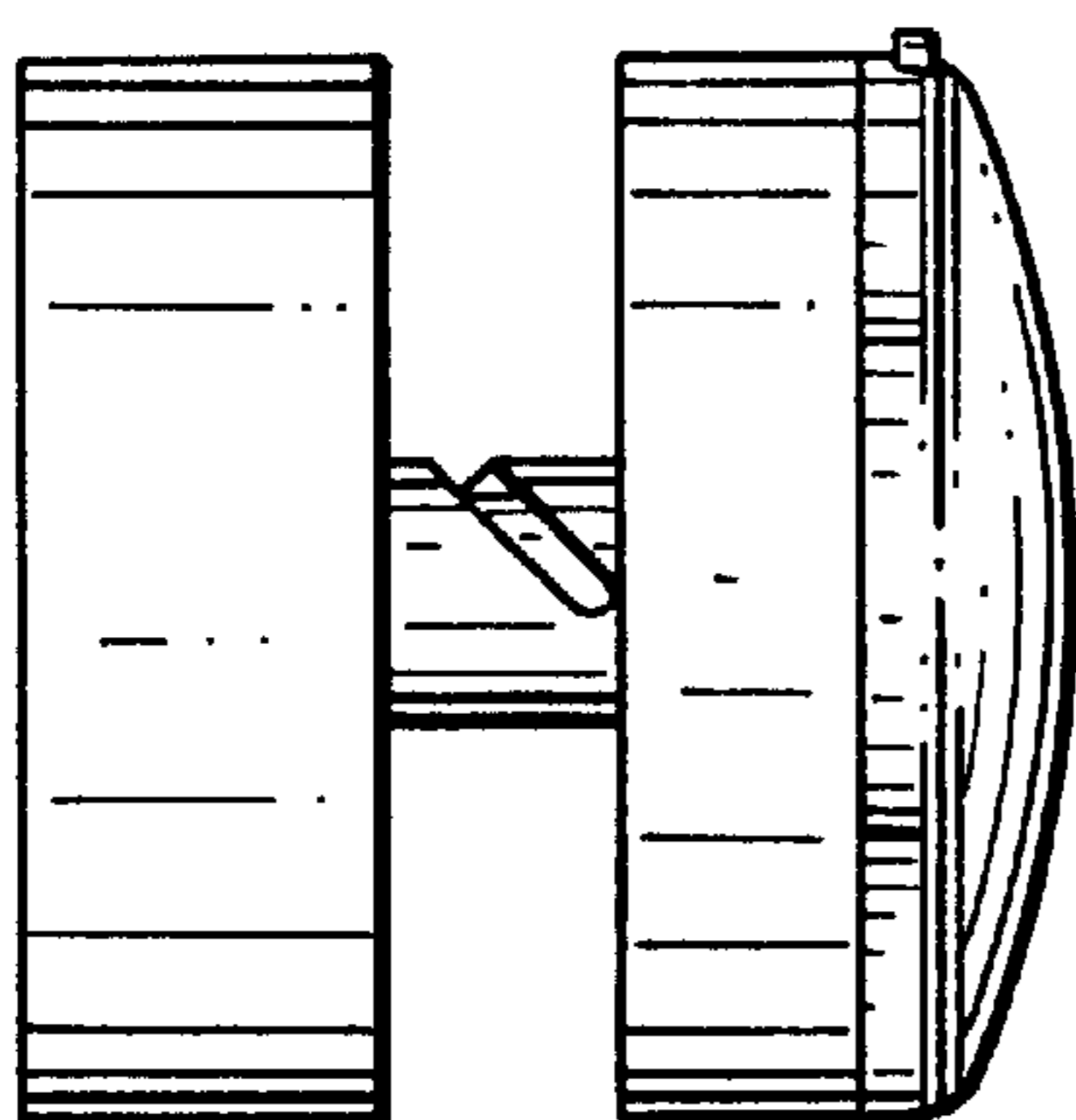

FIG. 9

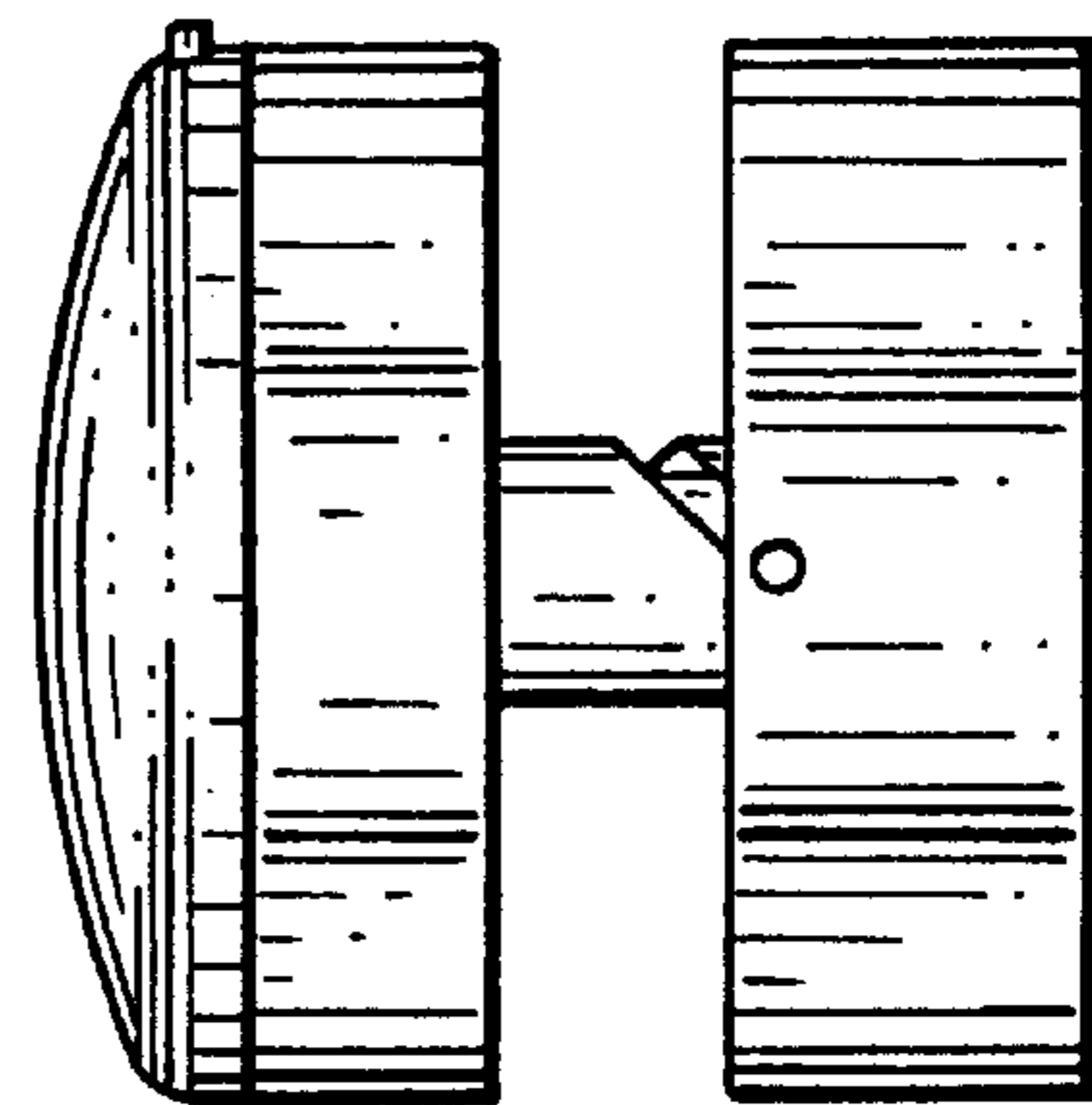

FIG. 10

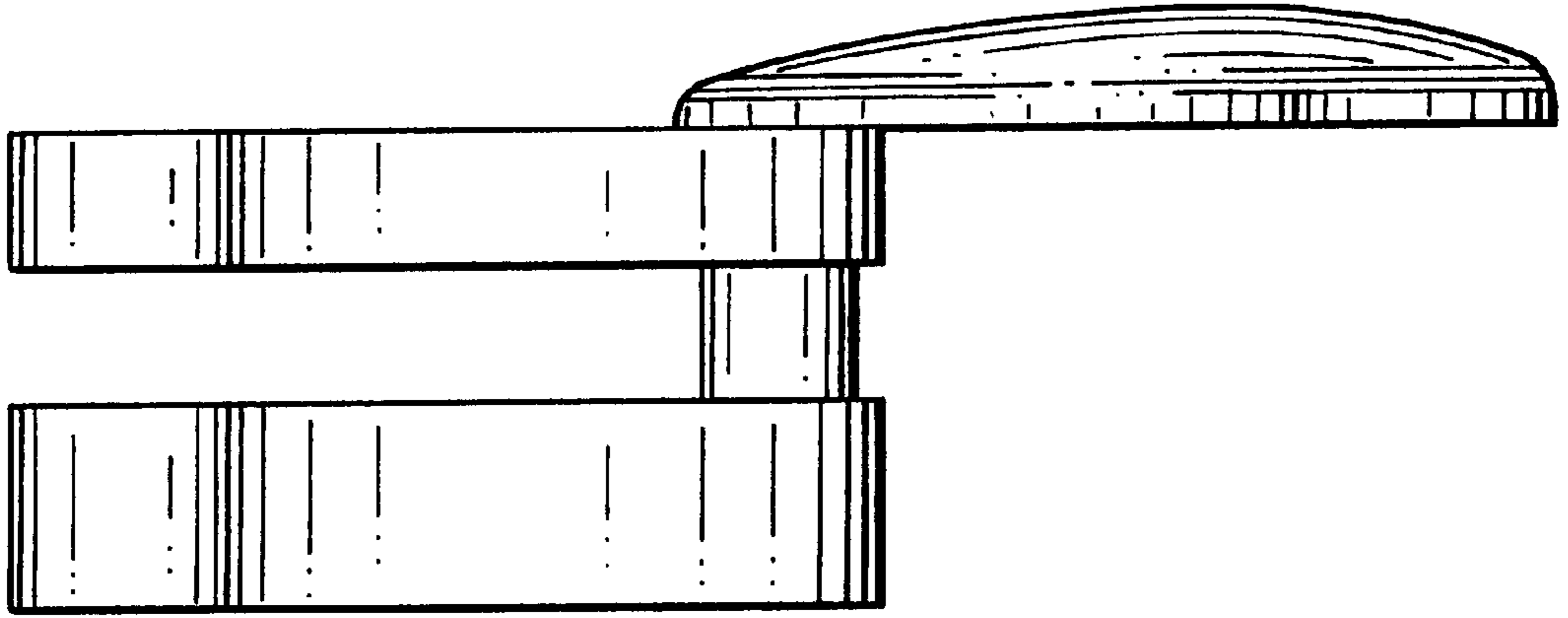

FIG. 11

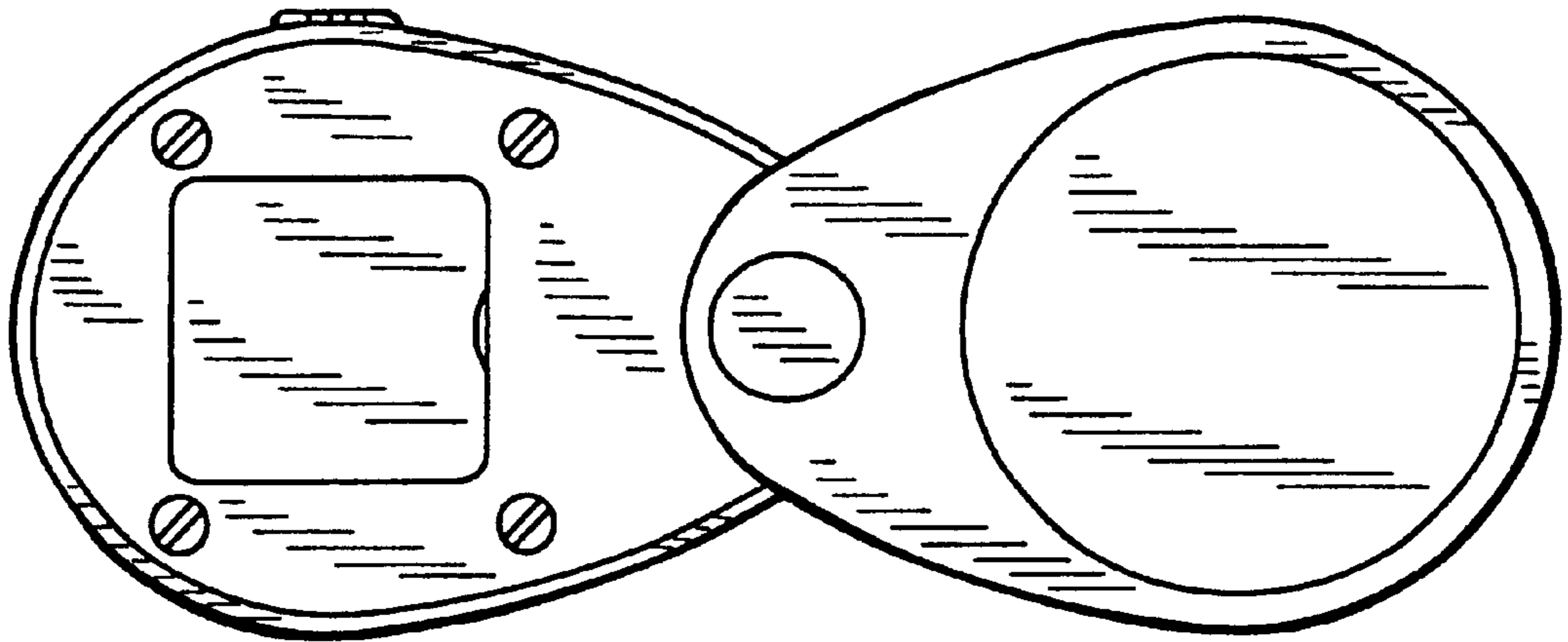

FIG. 12

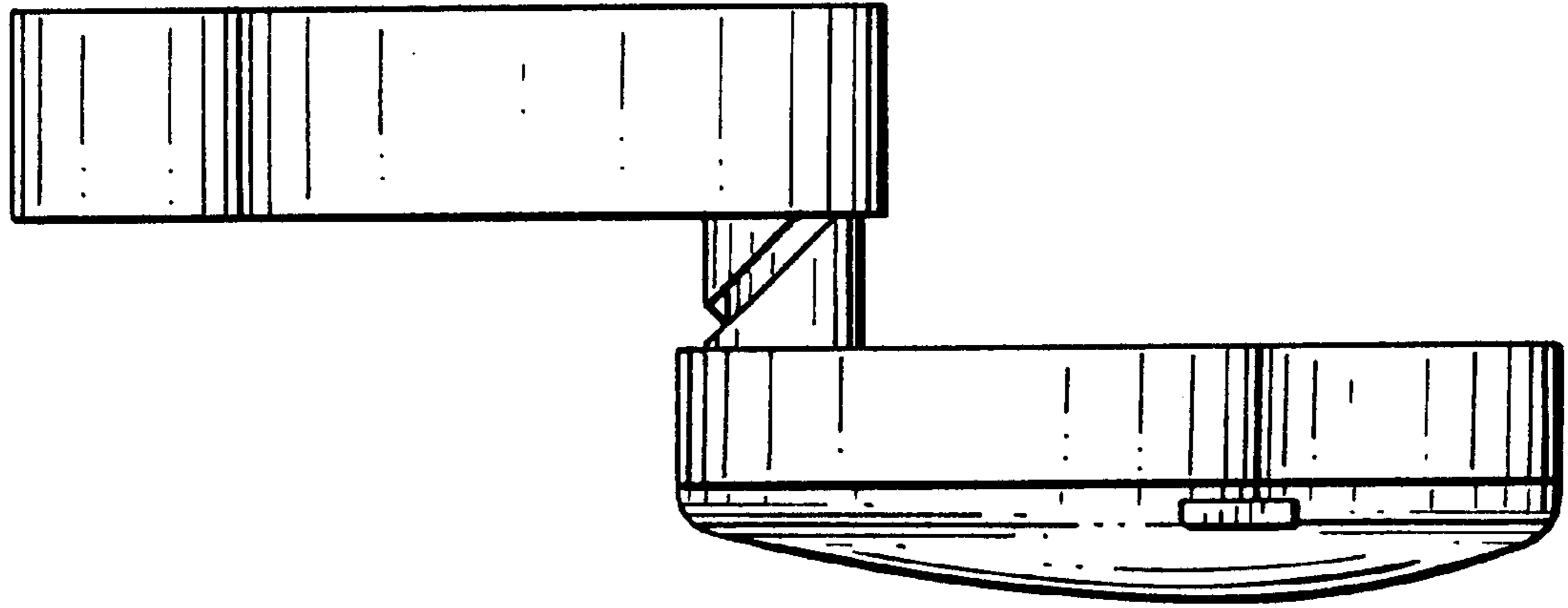

FIG. 13

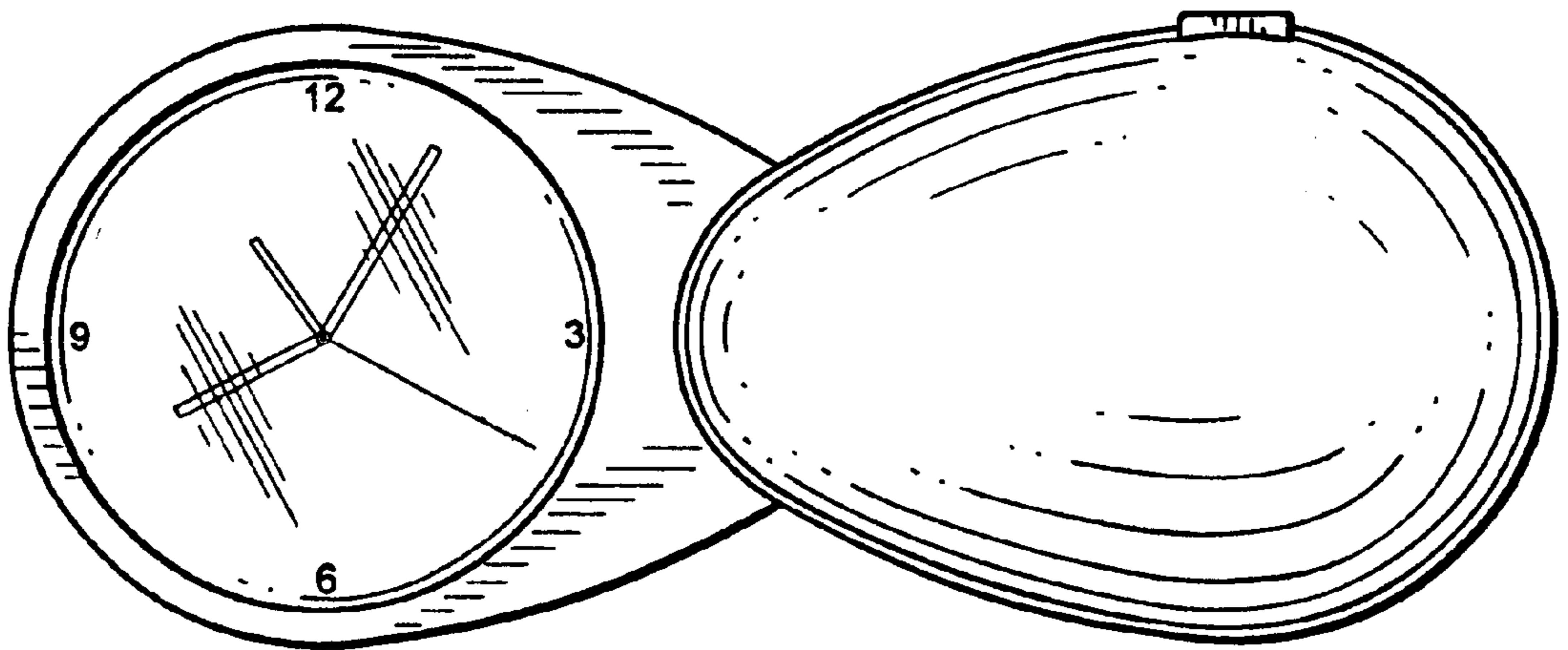

FIG. 14

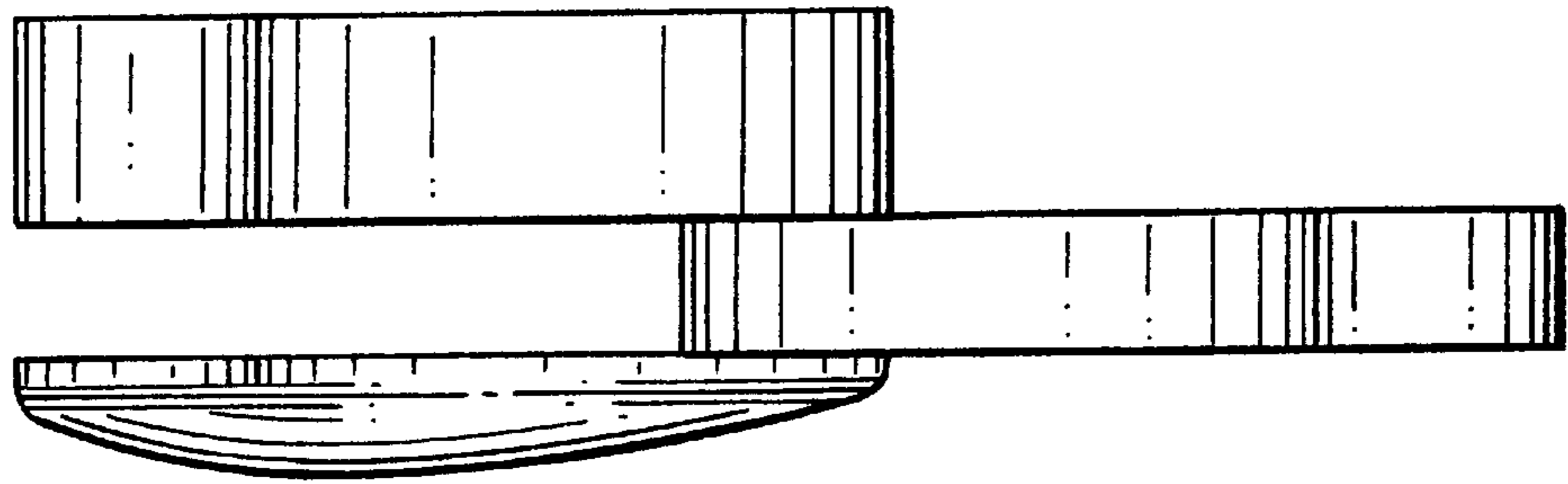

FIG. 15

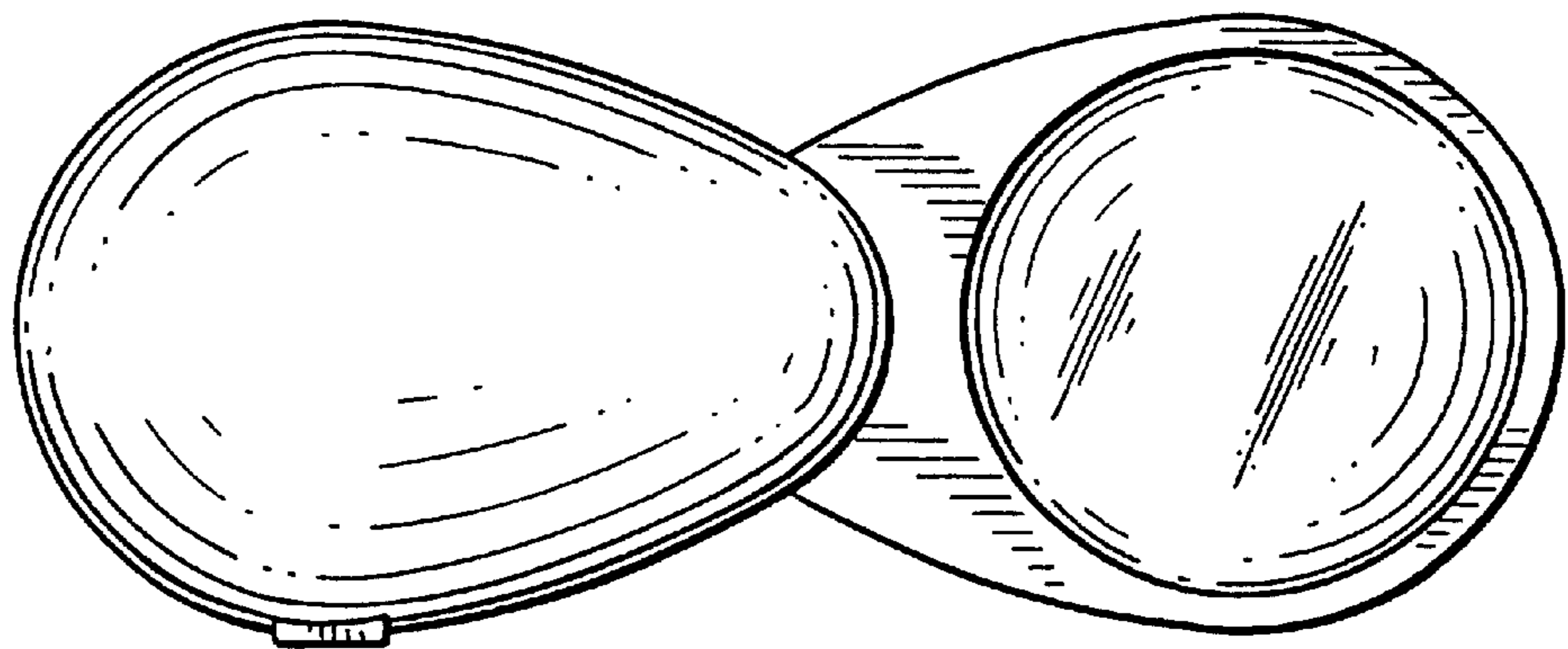

FIG. 16

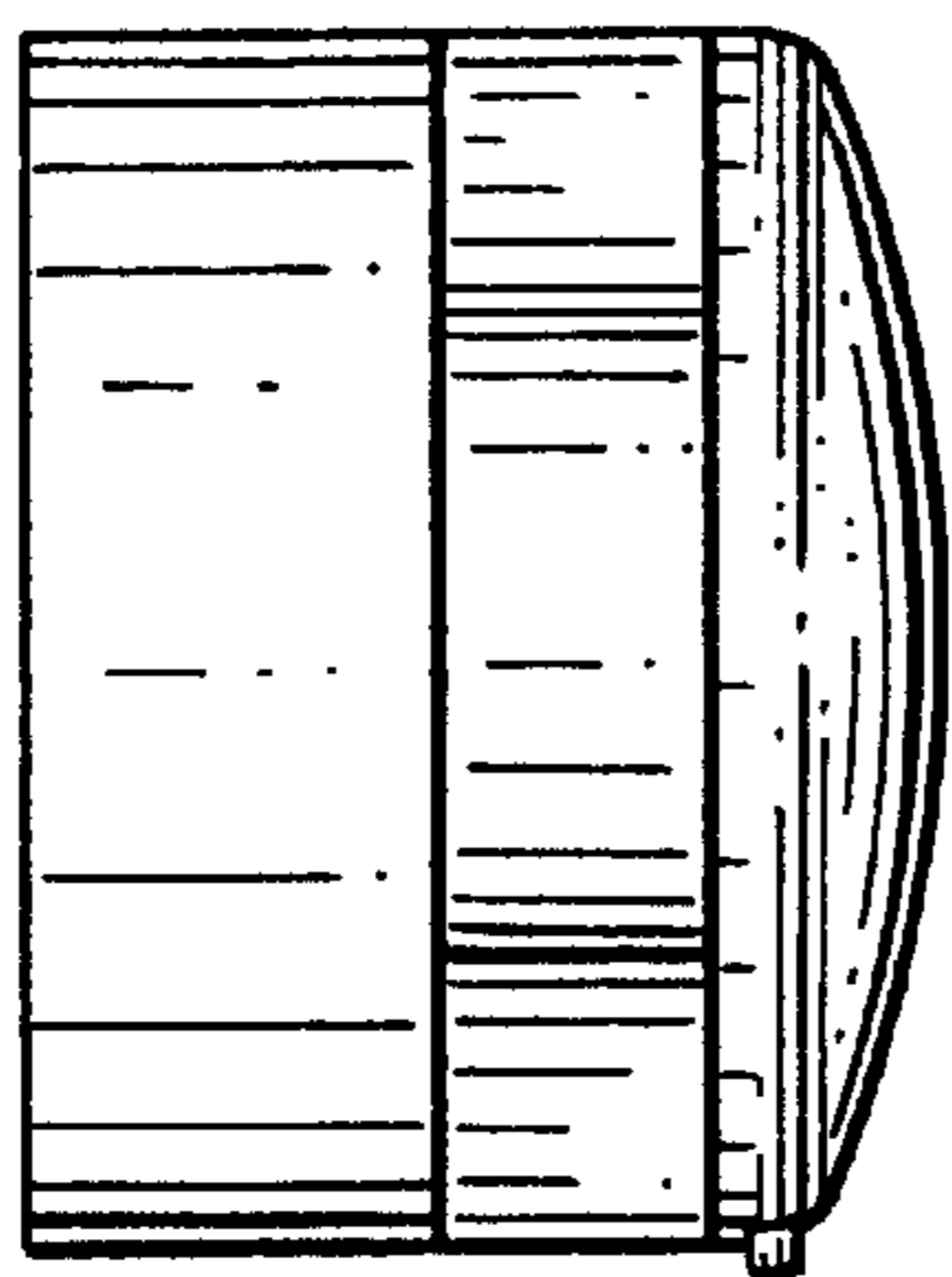

FIG. 17

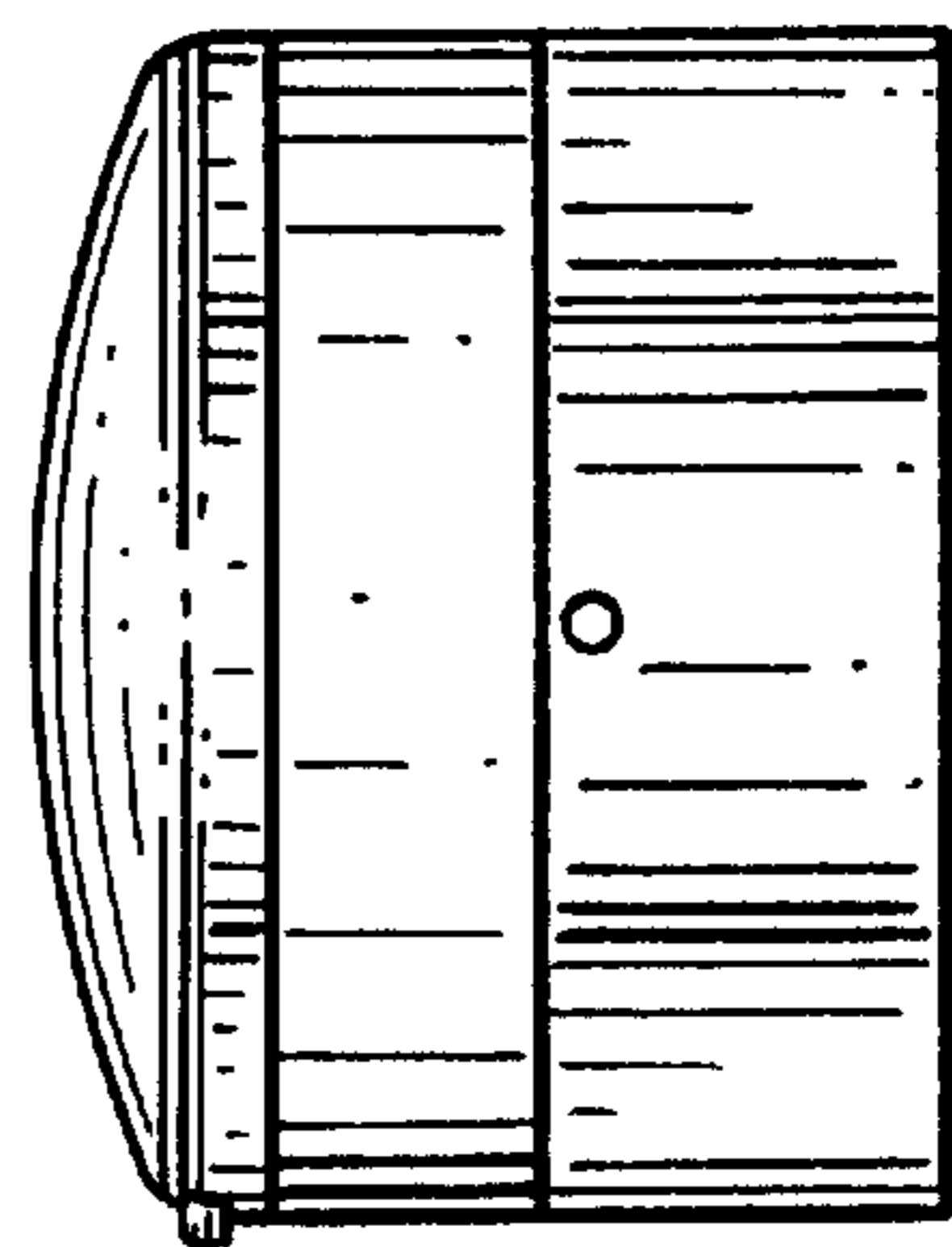

FIG. 18

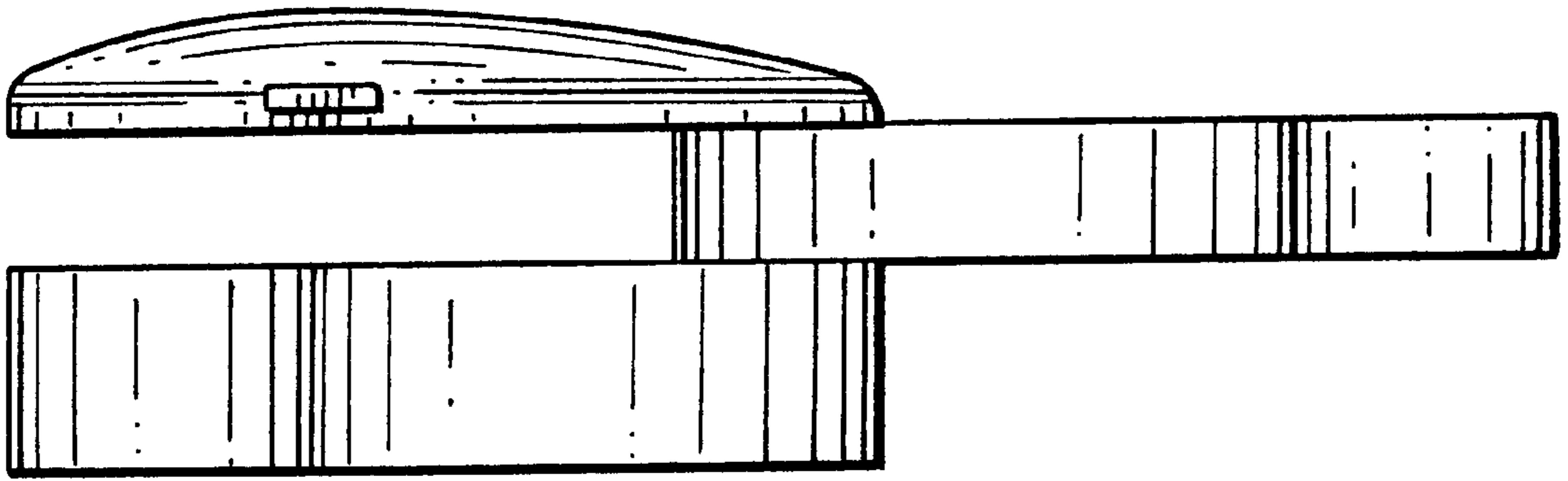

FIG. 19

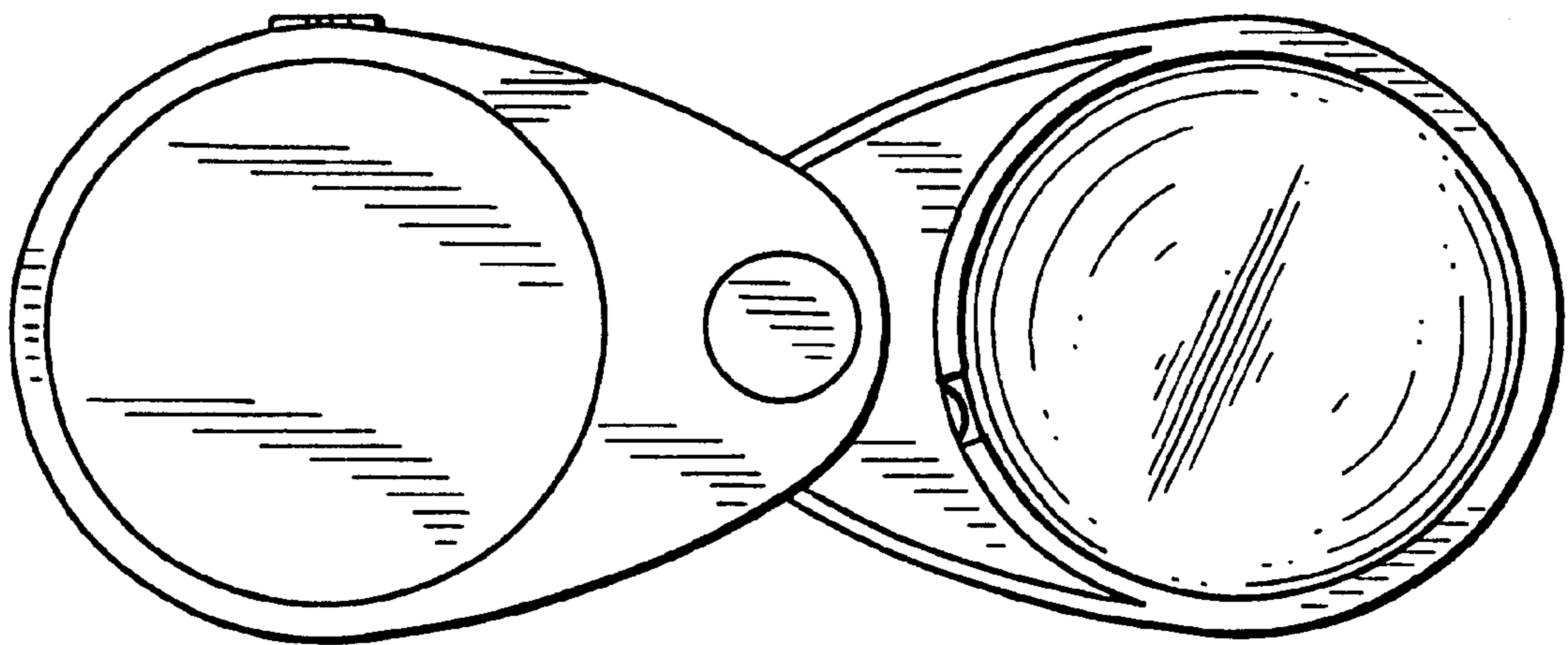

FIG. 20