



US00D451766B1

(12) **United States Design Patent**
King et al.

(10) **Patent No.:** **US D451,766 S**

(45) **Date of Patent:** **** Dec. 11, 2001**

(54) **COOLER AND JUG CONSTRUCTION**

(75) Inventors: **Paul King**, Newbury Park, CA (US);
Phillip Hague; **Paul M. Lesley**, both of
Chicago, IL (US)

(73) Assignee: **The Thermos Company**, Schaumburg,
IL (US)

(**) Term: **14 Years**

(21) Appl. No.: **29/132,747**

(22) Filed: **Nov. 14, 2000**

(51) **LOC (7) Cl.** **07-01**

(52) **U.S. Cl.** **D7/605**

(58) **Field of Search** D7/605-608, 312-322,
D7/510, 511; 62/457.1, 457.7, 371, 372;
220/592.2, 592.24-592.27, 915.1, 915.2;
215/12.1, 12.2, 13.1

(56) **References Cited**

U.S. PATENT DOCUMENTS

- D. 295,483 * 5/1988 Tarozzi et al. D7/605
- 6,105,844 * 8/2000 Walters et al. 220/915.2 X

OTHER PUBLICATIONS

HFD supplement, Feb. 1980, vacuum bottle.*

* cited by examiner

Primary Examiner—Terry A. Wallace

(74) *Attorney, Agent, or Firm*—Wood, Phillips, VanSanten,
Clark & Mortimer

(57) **CLAIM**

The ornamental design of a cooler and jug construction, as
shown and described.

DESCRIPTION

FIG. 1 is a perspective view of the inventive design from
above and from one side thereof;

FIG. 2 is a perspective view of the design from below and
from the side opposite that shown in FIG. 1;

FIG. 3 is a side elevation of the design, it being understood
that the opposite side is a mirror image of that shown in FIG.
3;

FIG. 4 is a top plan view of the design;

FIG. 5 is a bottom plan view of the design;

FIG. 6 is a side elevation taken from the right of FIG. 1; and,
FIG. 7 is a side elevation taken from the left of FIG. 1.

1 Claim, 4 Drawing Sheets

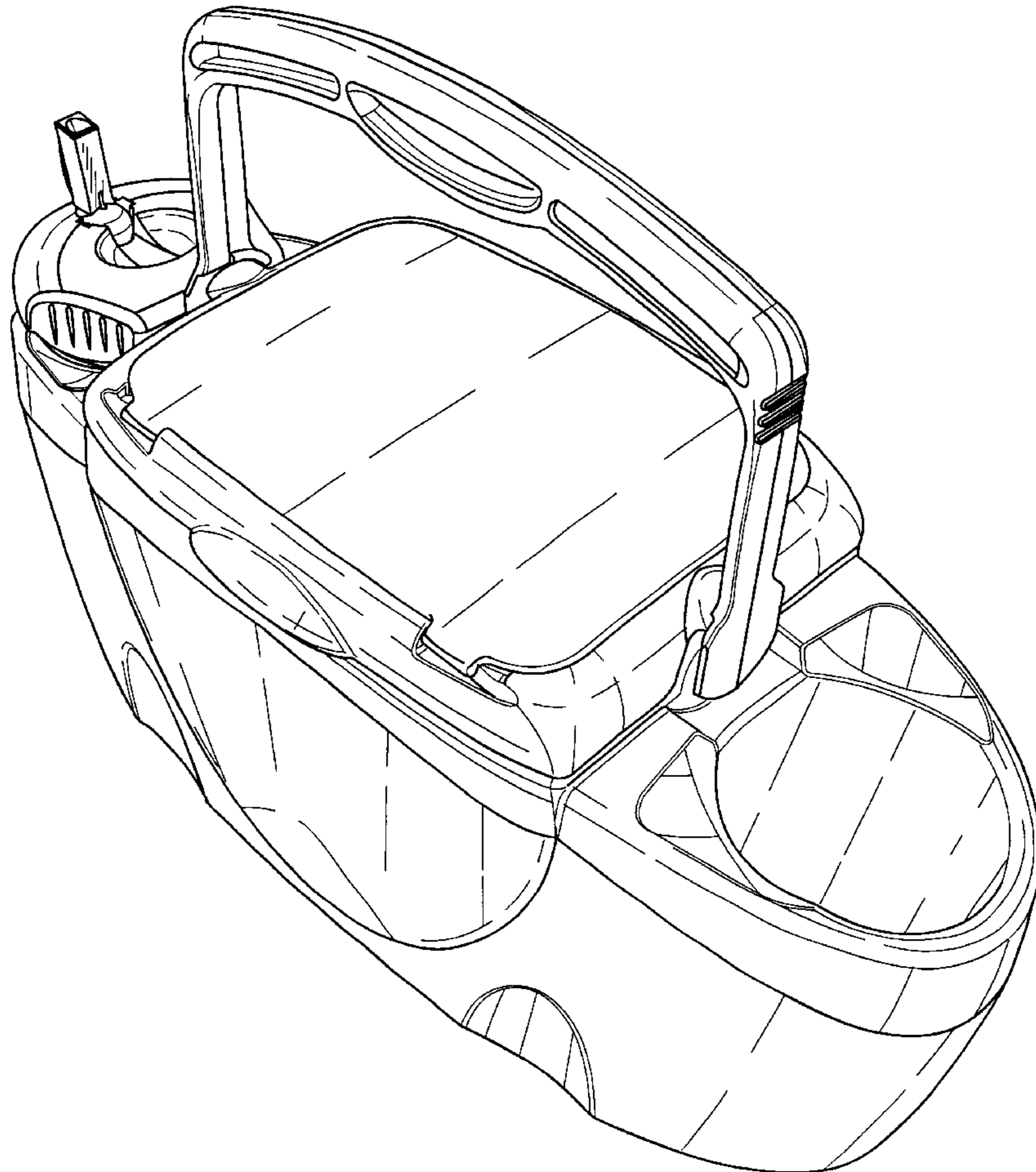

Fig. 1

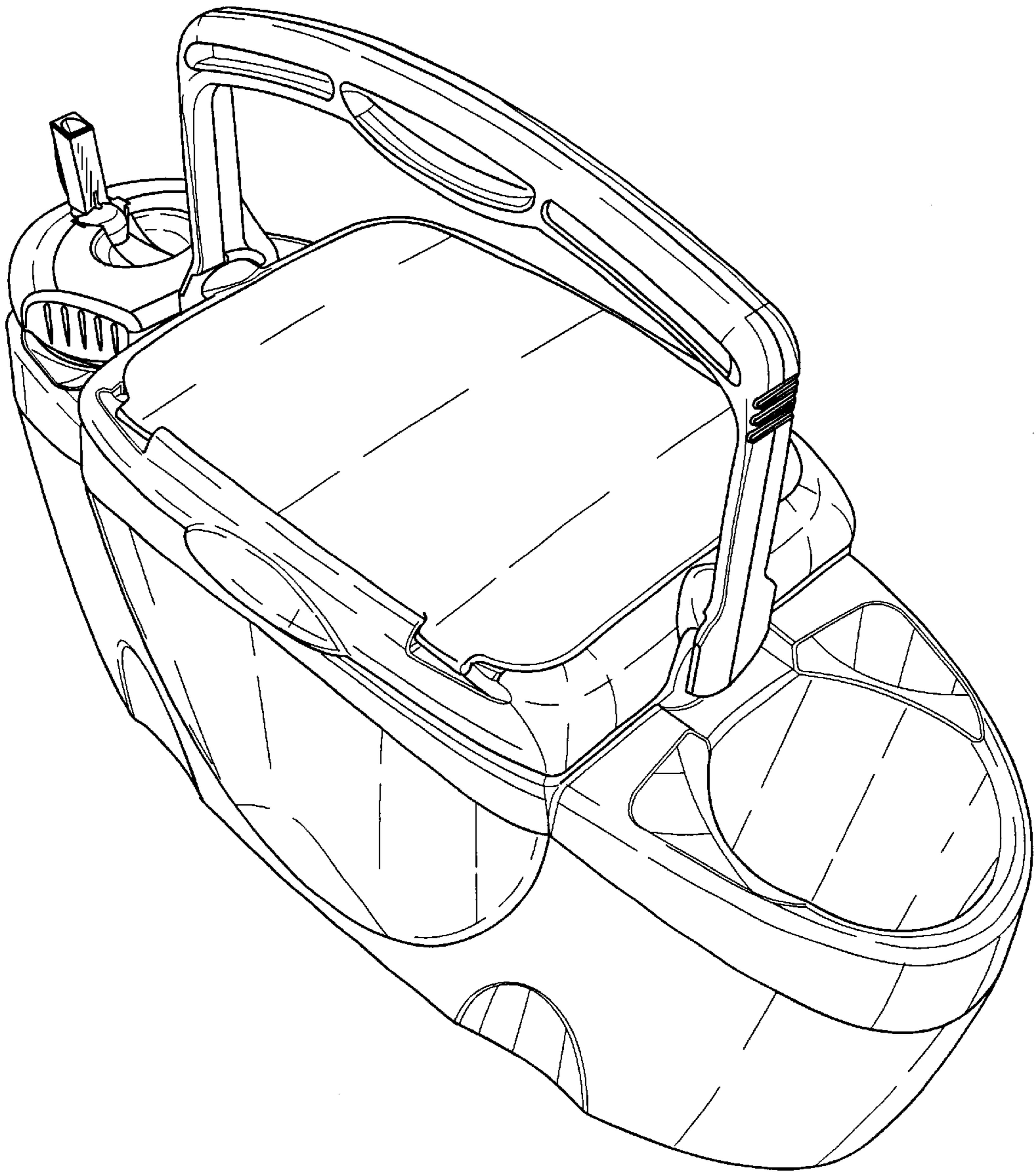

Fig. 2

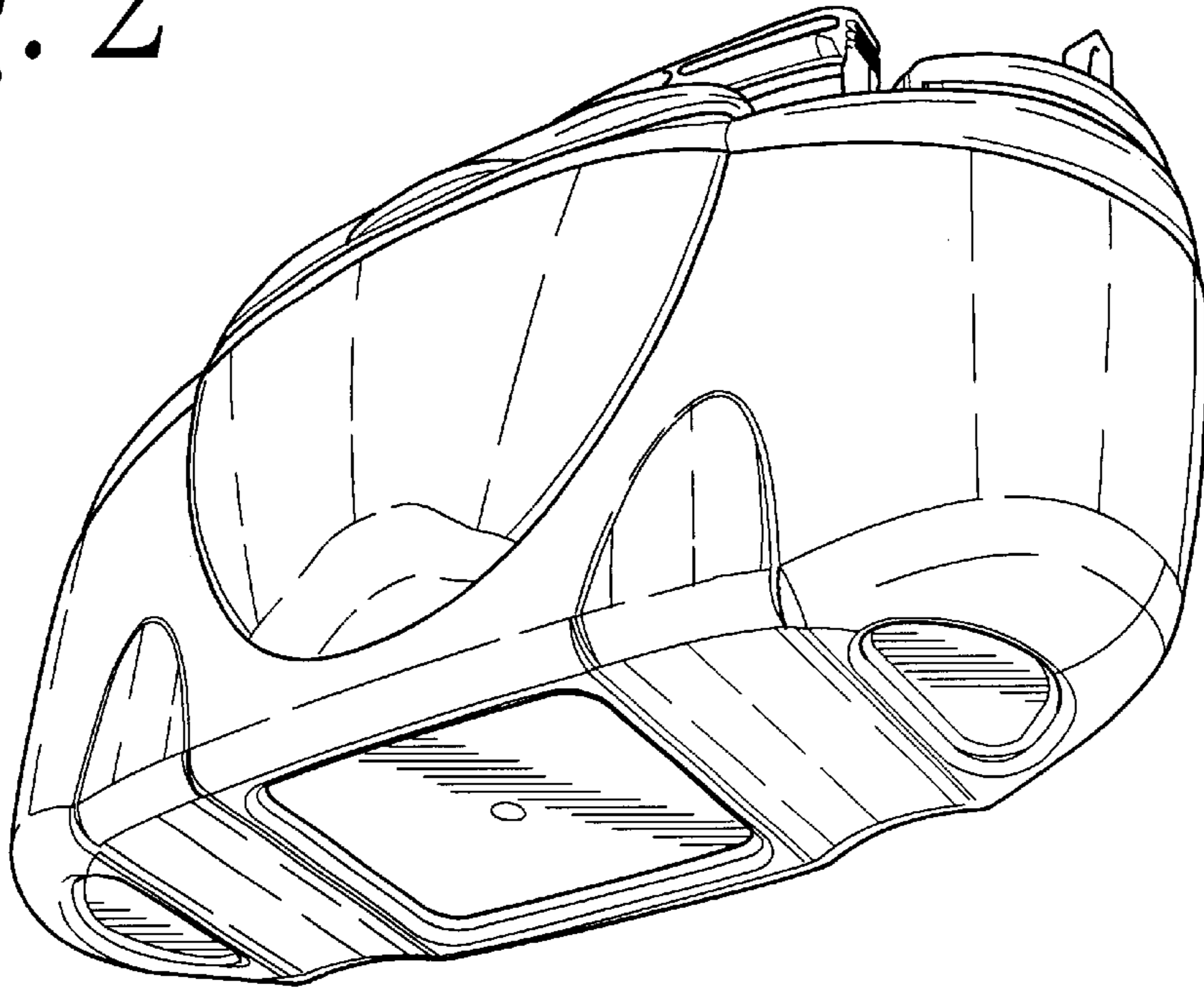

Fig. 3

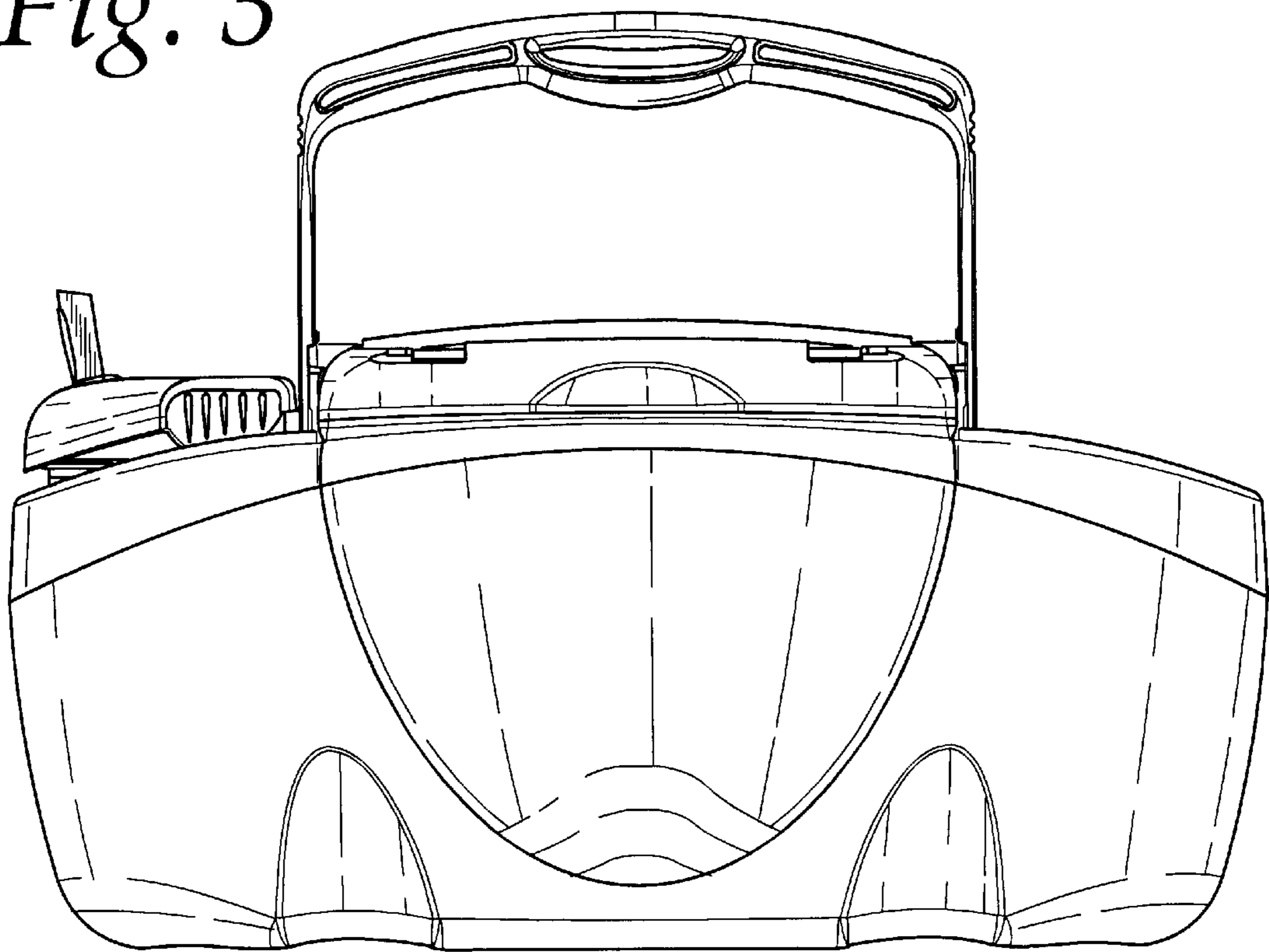

Fig. 4

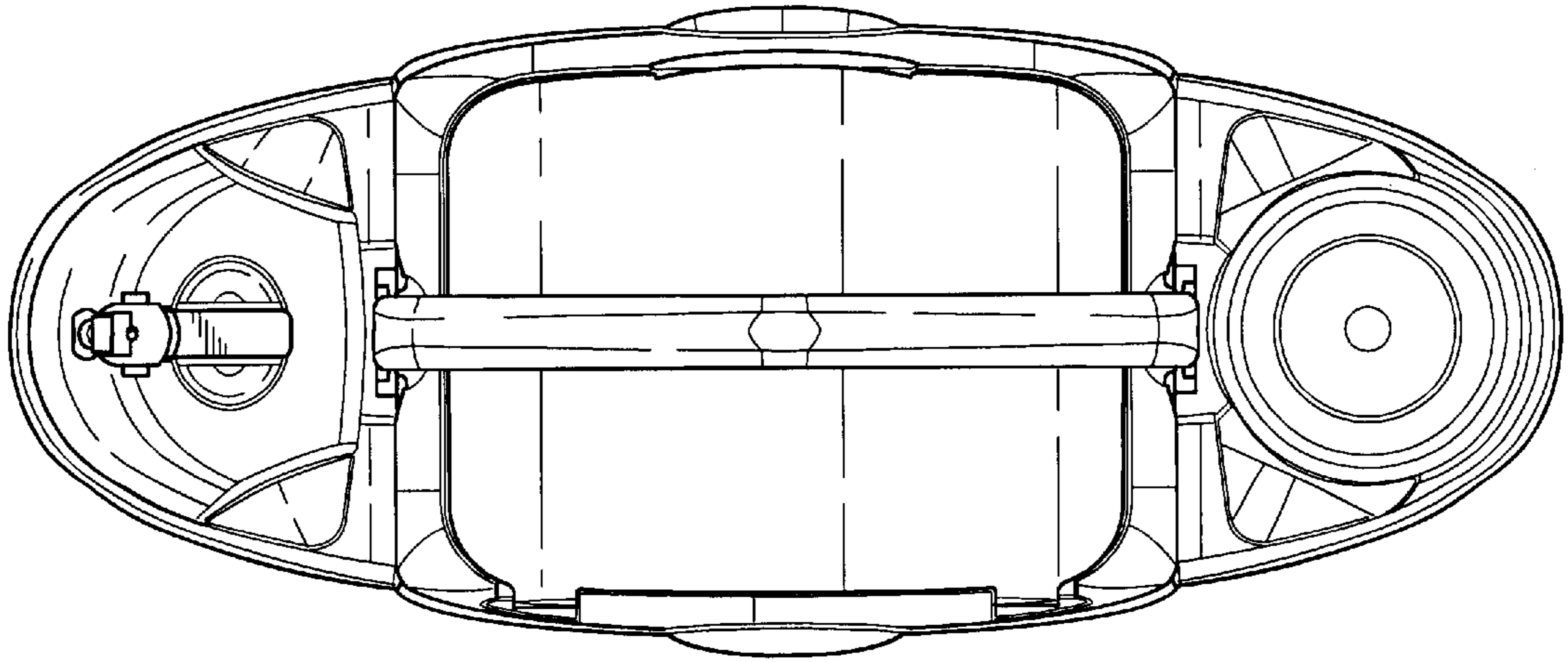

Fig. 5

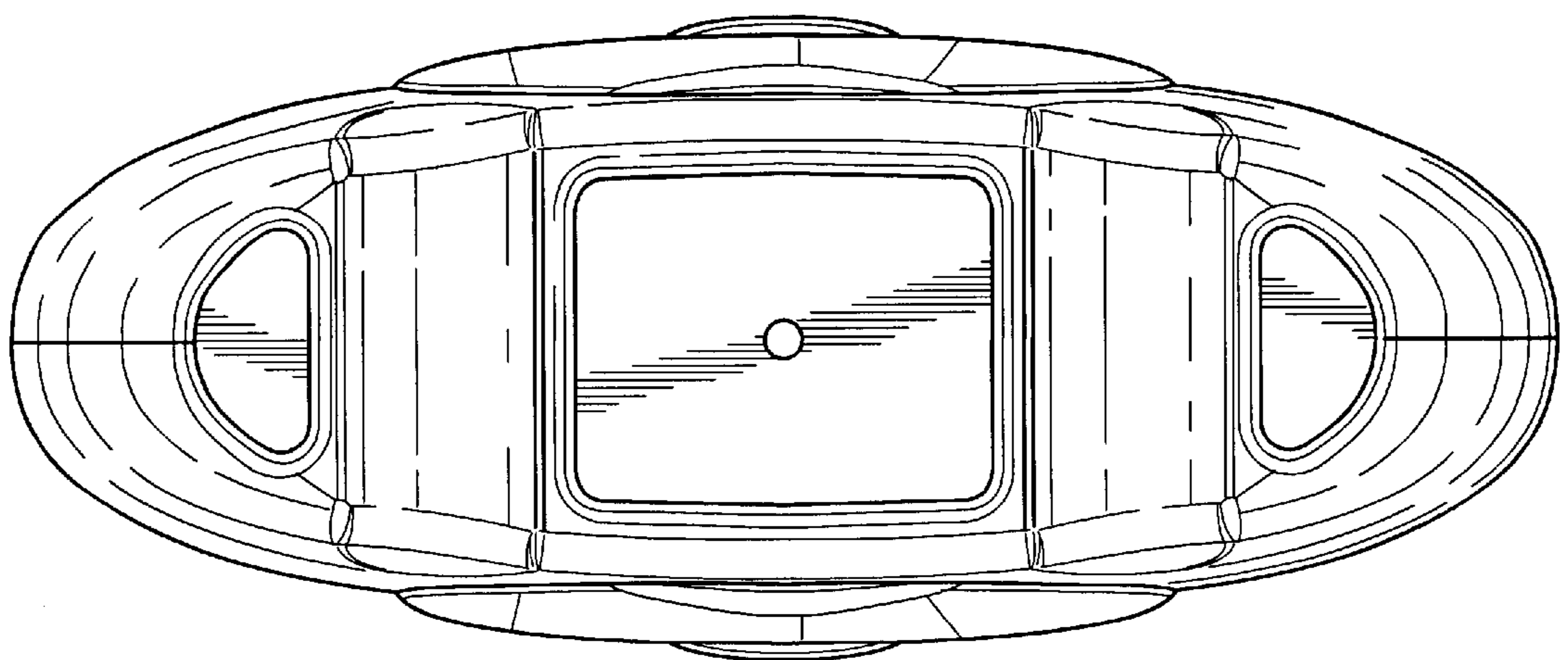

Fig. 6

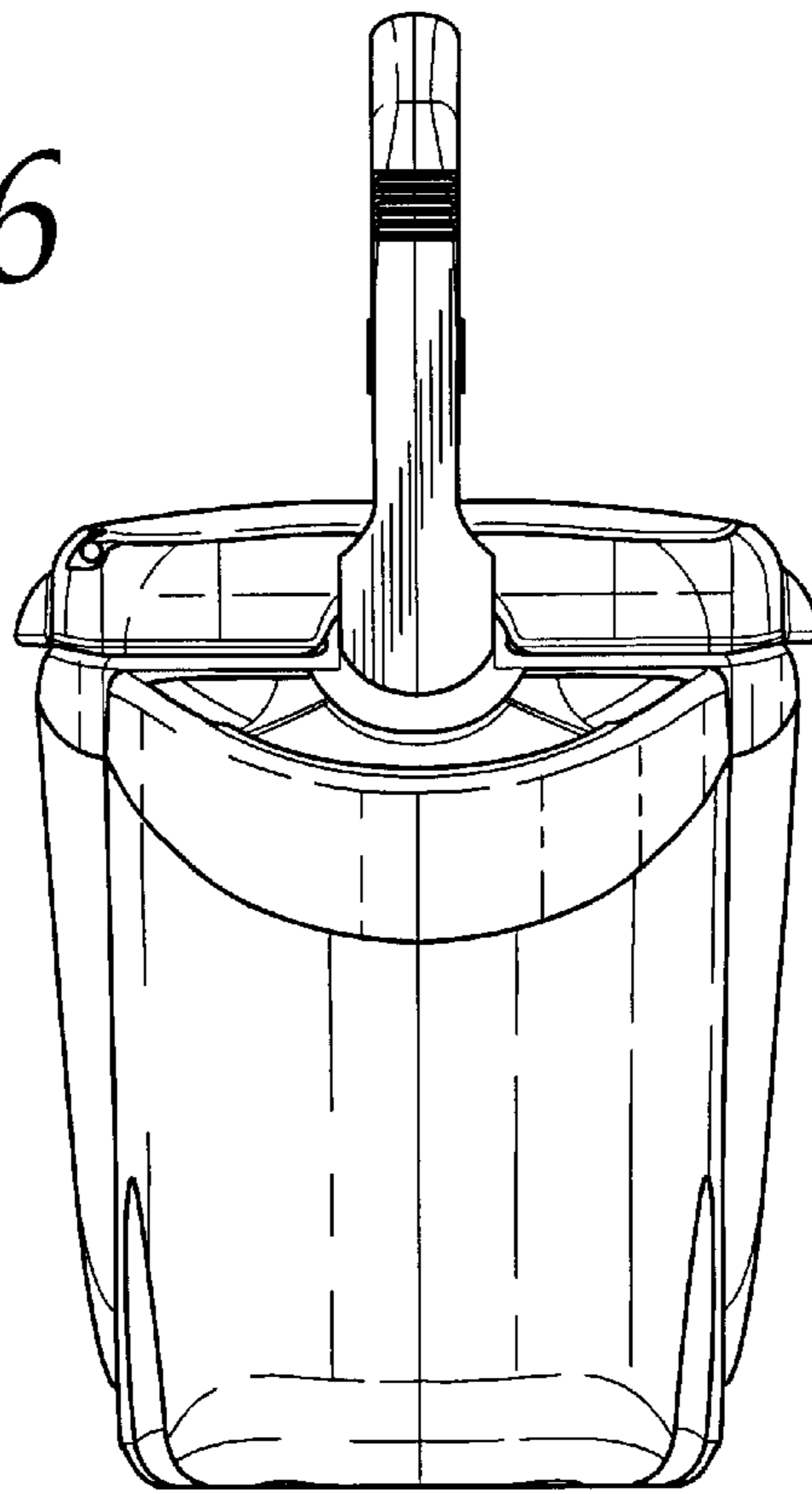

Fig. 7

