



US00D451710B1

(12) **United States Design Patent**  
**Camfferman**

(10) **Patent No.:** **US D451,710 S**

(45) **Date of Patent:** **\*\* Dec. 11, 2001**

(54) **FURNITURE ELEMENT**

(75) Inventor: **Brent J Camfferman**, Winnipeg (CA)

(73) Assignee: **Palliser Furniture Ltd.**, Winnipeg (CA)

(\*\*) Term: **14 Years**

(21) Appl. No.: **29/119,389**

(22) Filed: **Feb. 29, 2000**

(51) **LOC (7) Cl.** ..... **06-06**

(52) **U.S. Cl.** ..... **D6/491; D6/300; D6/503; D6/505**

(58) **Field of Search** ..... D6/382-389, 505-508, D6/392-395, 300-314; 5/53.1, 279.1, 280, 281, 907; 40/700, 711, 720, 722, 723, 724, 725, 735, 765, 779, 780, 786, 790, 798; 359/838, 850, 865, 871, 872, 877; 248/469

(56) **References Cited**

**U.S. PATENT DOCUMENTS**

- D. 181,988 \* 1/1958 Lubberts et al. .... D6/507
- D. 343,744 \* 2/1994 Keller ..... D6/444
- D. 364,963 \* 12/1995 Paus ..... D6/300
- D. 433,586 \* 11/2000 Camfferman ..... D6/491

**OTHER PUBLICATIONS**

Ethan Allen, c1993, p. 276, mirror at left and center.\*

\* cited by examiner

*Primary Examiner*—Janice E. Seeger

(74) *Attorney, Agent, or Firm*—Christensen O'Connor Johnson Kindness PLLC

(57) **CLAIM**

The ornamental design for a furniture element, as shown and described.

**DESCRIPTION**

FIG. 1 is a front, right side perspective view of a furniture element embodying my design, the front, left side perspective view being a mirror image;

FIG. 2 is a front view of the bedboard of FIG. 1; the rear view is the same as the front view;

FIG. 3 is a top view of the bedboard of FIG. 1;

FIG. 4 is a bottom view of the bedboard of FIG. 1;

FIG. 5 is a right side elevational view of the bedboard of FIG. 1 and the left side elevational view is the same;

FIG. 6 is a cross-sectional view at 6—6 in FIG. 2;

FIG. 7 is a cross-sectional view at 7—7 in FIG. 2;

FIG. 8 is a front, right side perspective view of a furniture element, showing an alternative embodiment of my design in a mirror;

FIG. 9 is a front view, the rear being the same;

FIG. 10 is a top plan view;

FIG. 11 is a right side elevational view, the left side being a mirror image thereof;

FIG. 12 is a front view, like FIG. 9, but showing cross-sections;

FIG. 13 is a cross-sectional view at 13—13 in FIG. 12; and,

FIG. 14 is a cross-sectional view at 14—14 in FIG. 12.

The features shown in dotted lines do not form part of the claimed design.

**1 Claim, 5 Drawing Sheets**

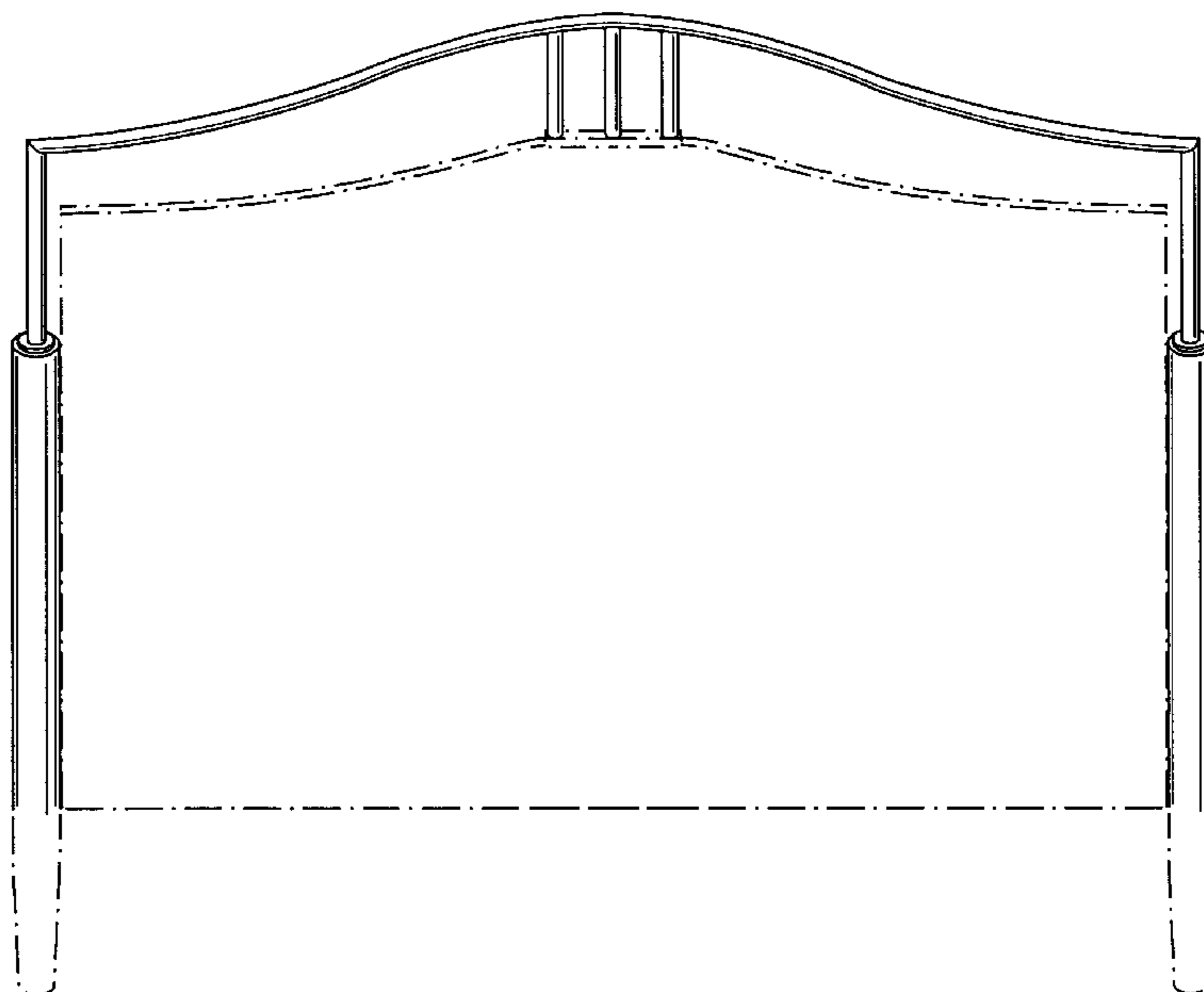

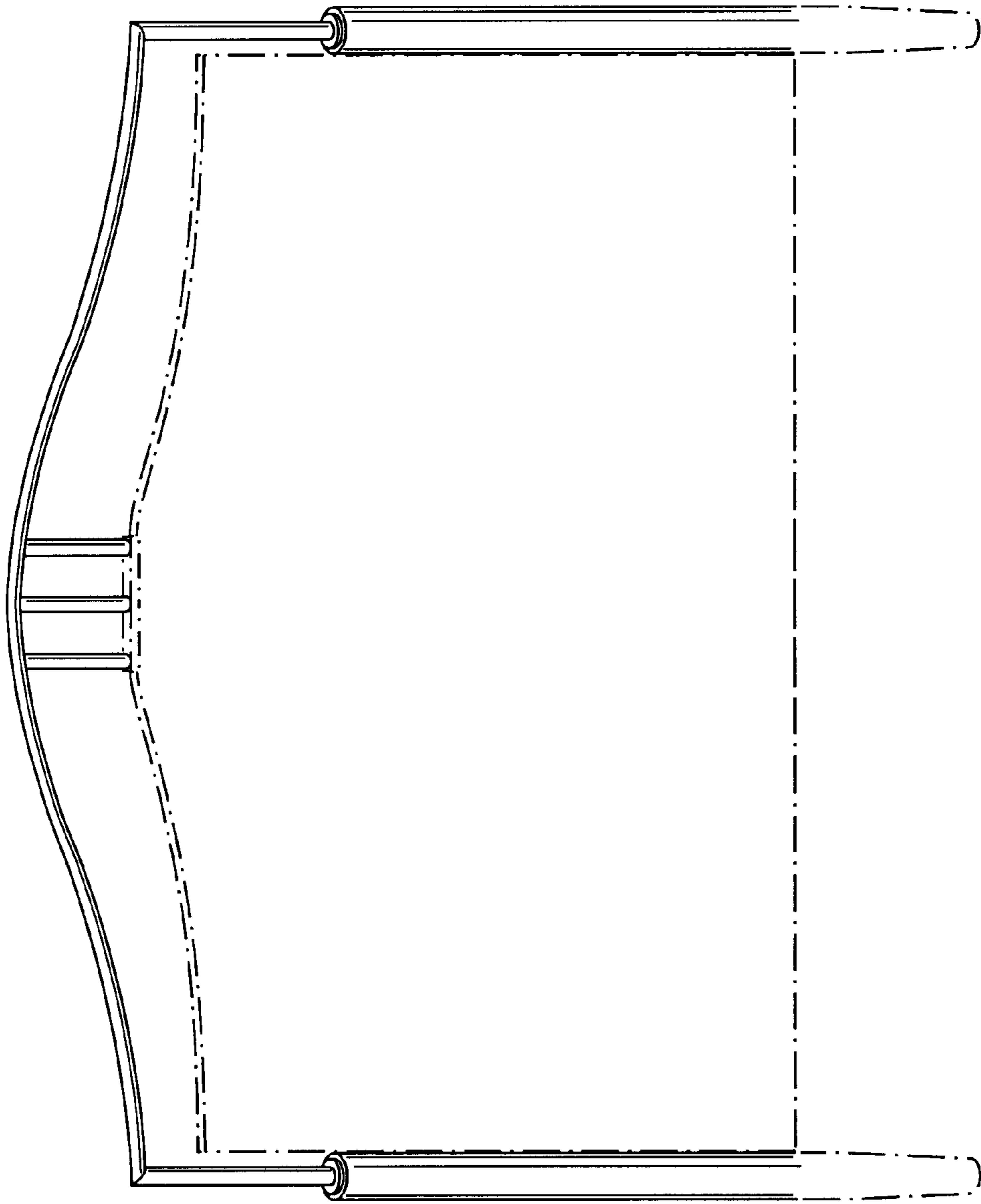

FIG. 1

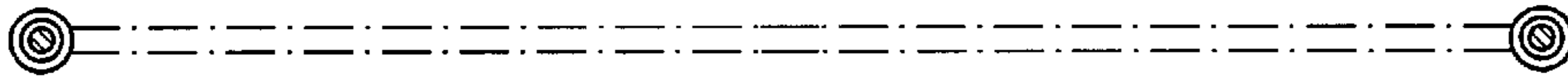

FIG. 7



FIG. 6

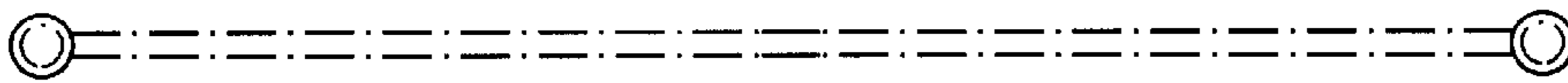

FIG. 4

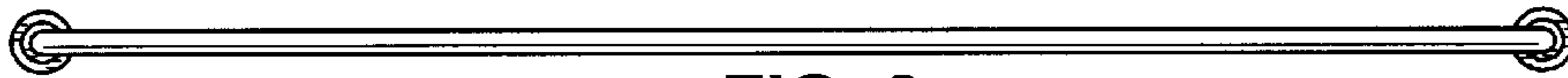

FIG. 3

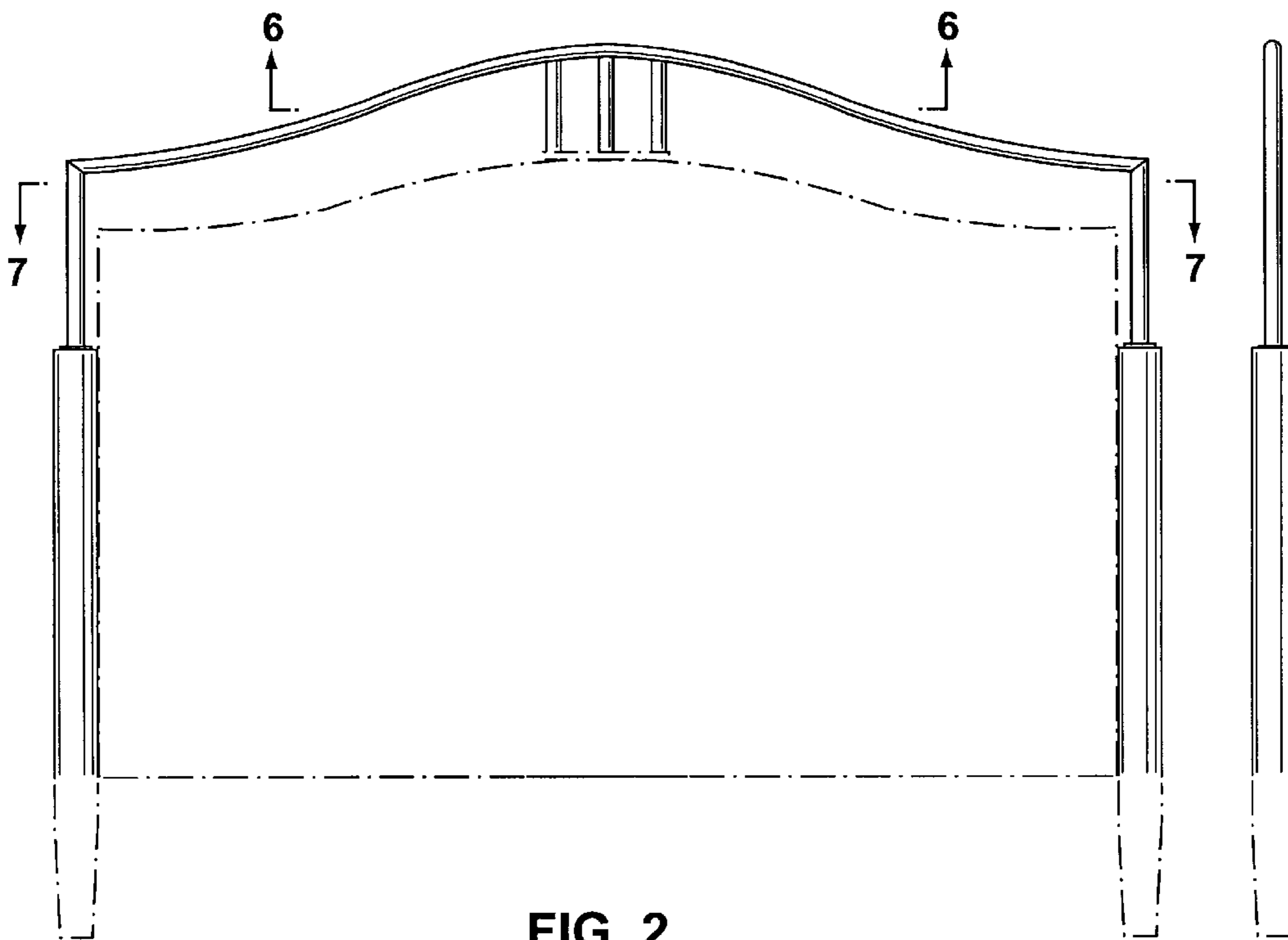

FIG. 2

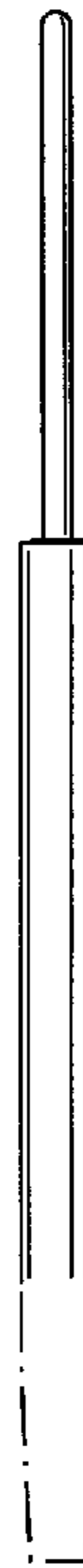
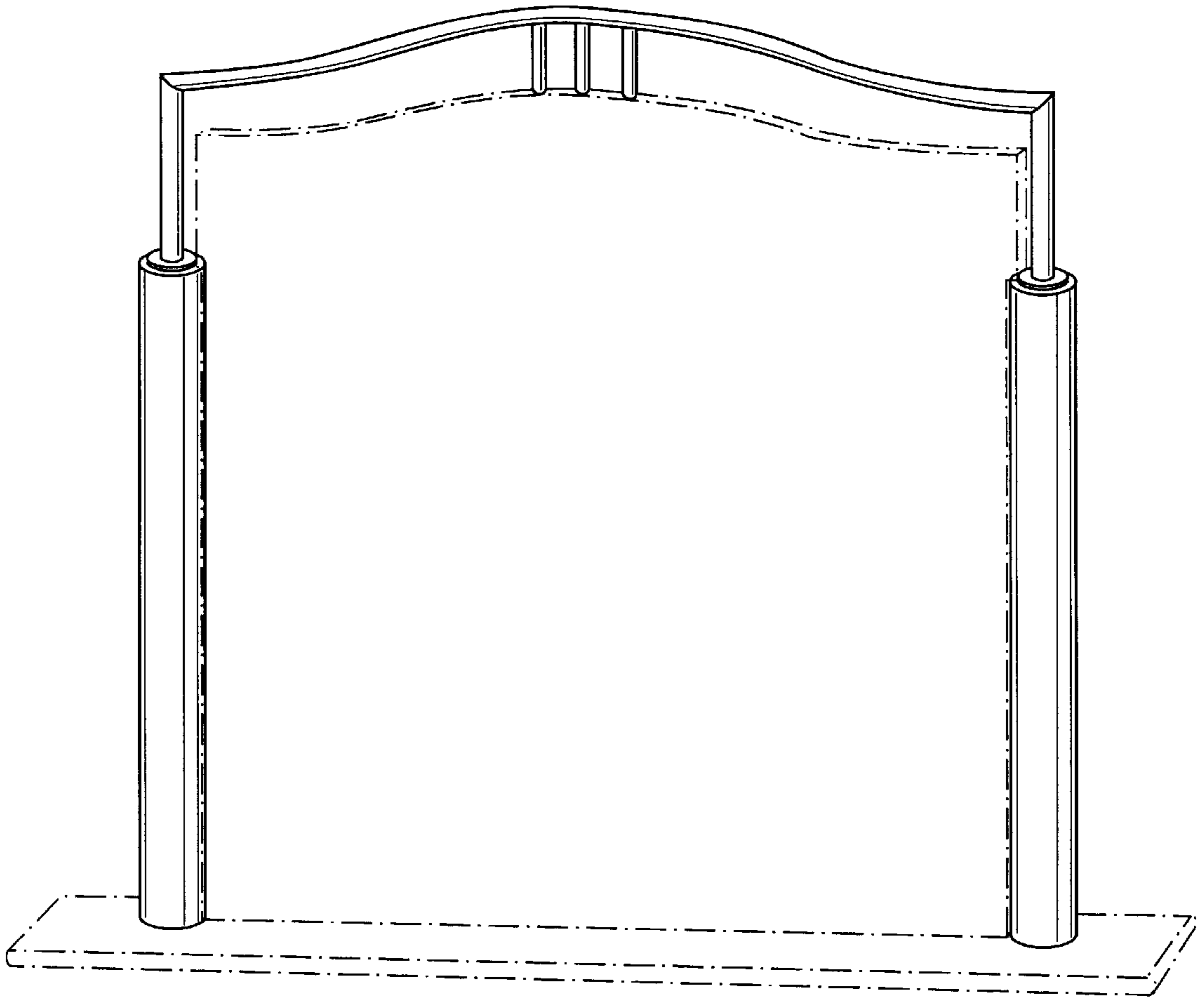
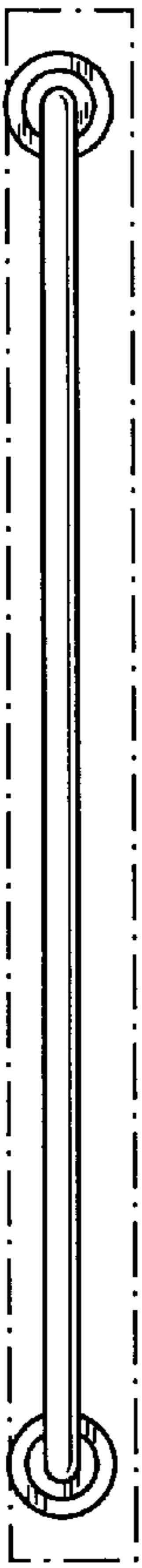

FIG. 5



**FIG. 8**



**FIG. 10**

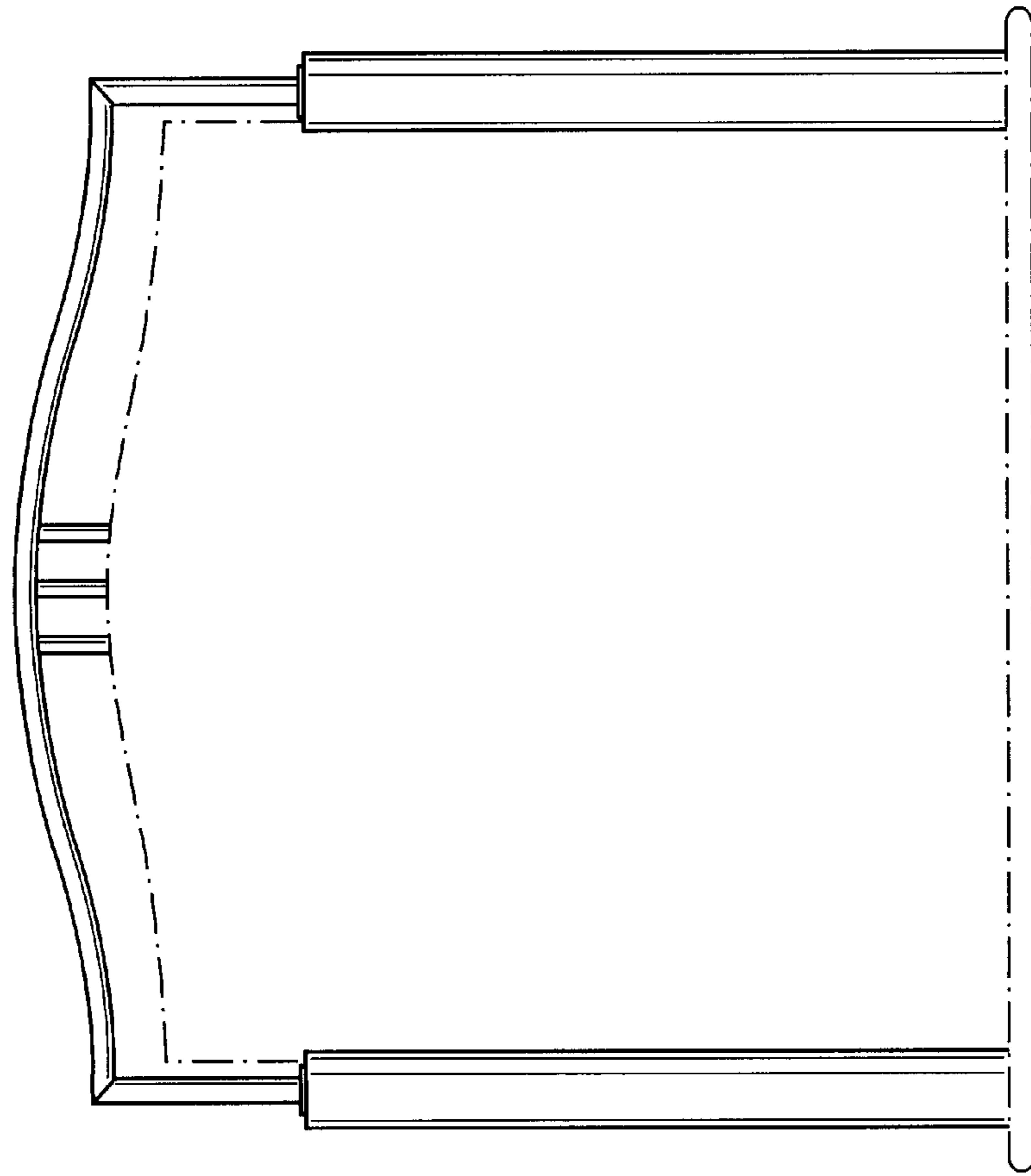

**FIG. 9**

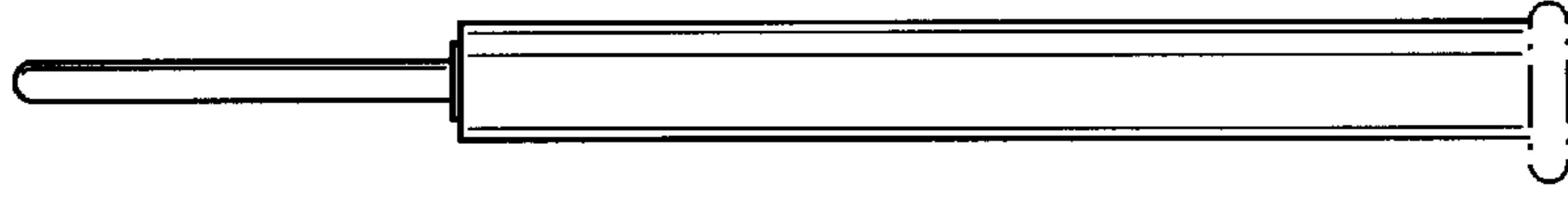

**FIG. 11**

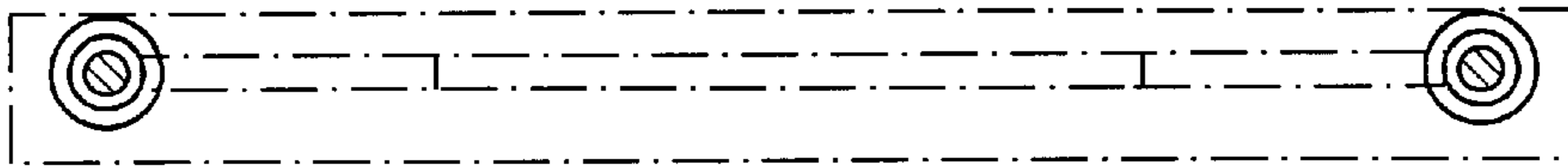

**FIG. 14**

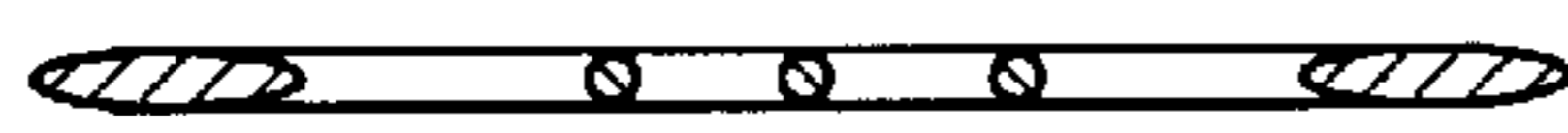

**FIG. 13**

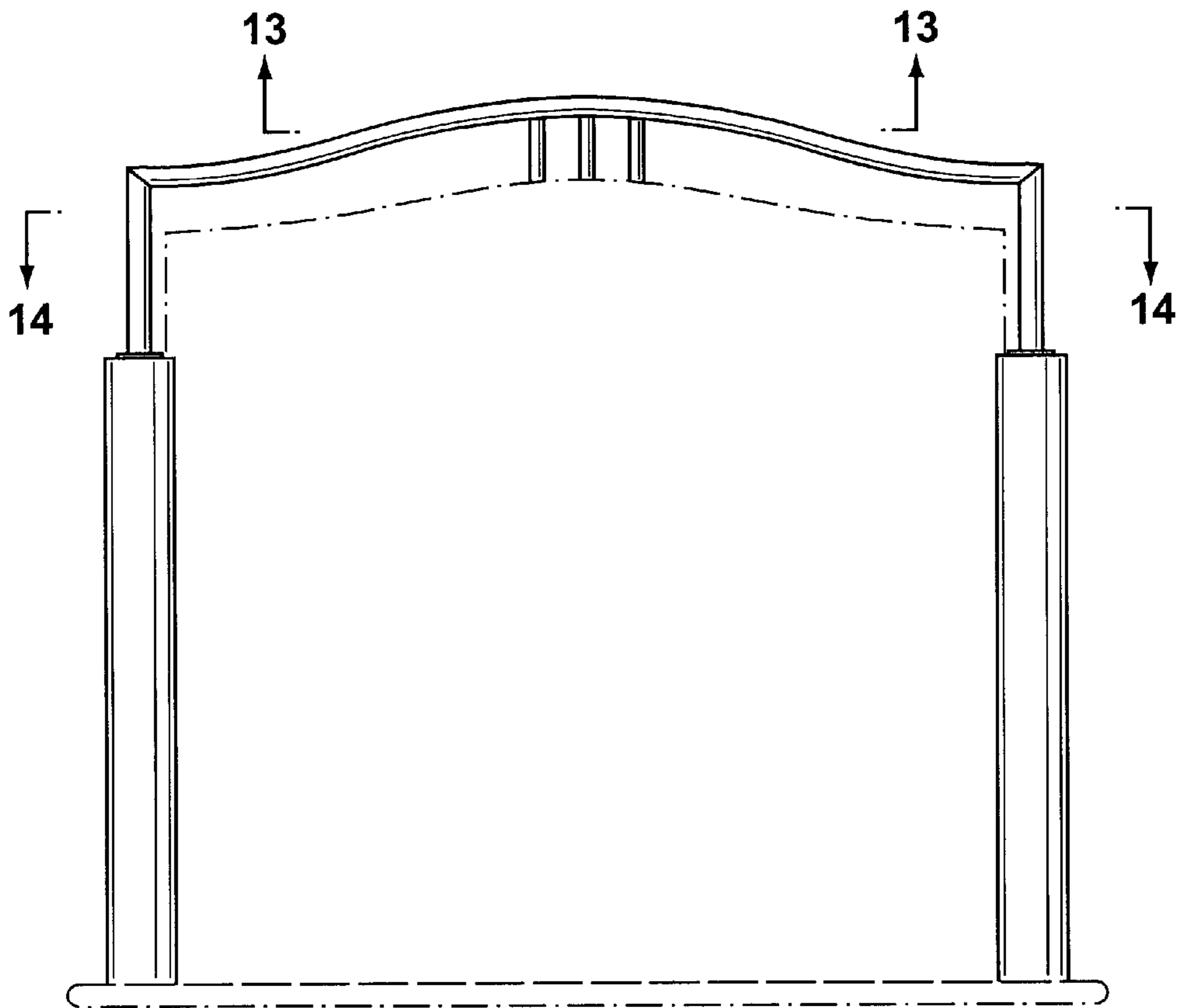

**FIG. 12**