

US00D451689B1

(12) **United States Design Patent**
Chen et al.

(10) **Patent No.:** **US D451,689 S**

(45) **Date of Patent:** **** Dec. 11, 2001**

(54) **BABY SEAT**

(75) Inventors: **Er-Jui Chen**, Feng-Shan; **Ling-Chuan Chang**, Chia-I; **Cheng-Fan Yang**, Tainan Hsien, all of (TW)

(73) Assignee: **Link Treasure Limited**, Tortola (VG)

(**) Term: **14 Years**

(21) Appl. No.: **29/128,116**

(22) Filed: **Aug. 17, 2000**

(51) **LOC (7) Cl.** **06-01**

(52) **U.S. Cl.** **D6/339**

(58) **Field of Search** D6/333, 334, 335, D6/336, 338, 339, 344, 347, 348, 379, 390, 391, 491, 500-502; D12/128, 129; 297/148, 149, 153, 174, 250.1, 467

(56) **References Cited**

U.S. PATENT DOCUMENTS

- D. 344,189 * 2/1994 Golenz et al. D6/339
- D. 351,289 * 10/1994 Stephens et al. D6/344
- D. 386,911 * 12/1997 Perego D6/339

- D. 426,965 * 6/2000 Wu D6/339
- D. 428,715 * 8/2000 Brevi D6/339
- 5,238,292 * 8/1993 Golenz et al. 297/153
- 5,820,207 * 10/1998 Wang 297/148

* cited by examiner

Primary Examiner—Gary D. Watson

Assistant Examiner—Mimosa De

(74) *Attorney, Agent, or Firm*—W. Wayne Liauh

(57) **CLAIM**

The ornamental design for a baby seat, as shown and described.

DESCRIPTION

FIG. 1 is a perspective view of a baby seat showing our new design;
 FIG. 2 is right side elevational view thereof;
 FIG. 3 is a top view thereof;
 FIG. 4 is front view thereof;
 FIG. 5 is a bottom view thereof;
 FIG. 6 is a left side elevational view thereof; and,
 FIG. 7 is a rear view thereof.

1 Claim, 7 Drawing Sheets

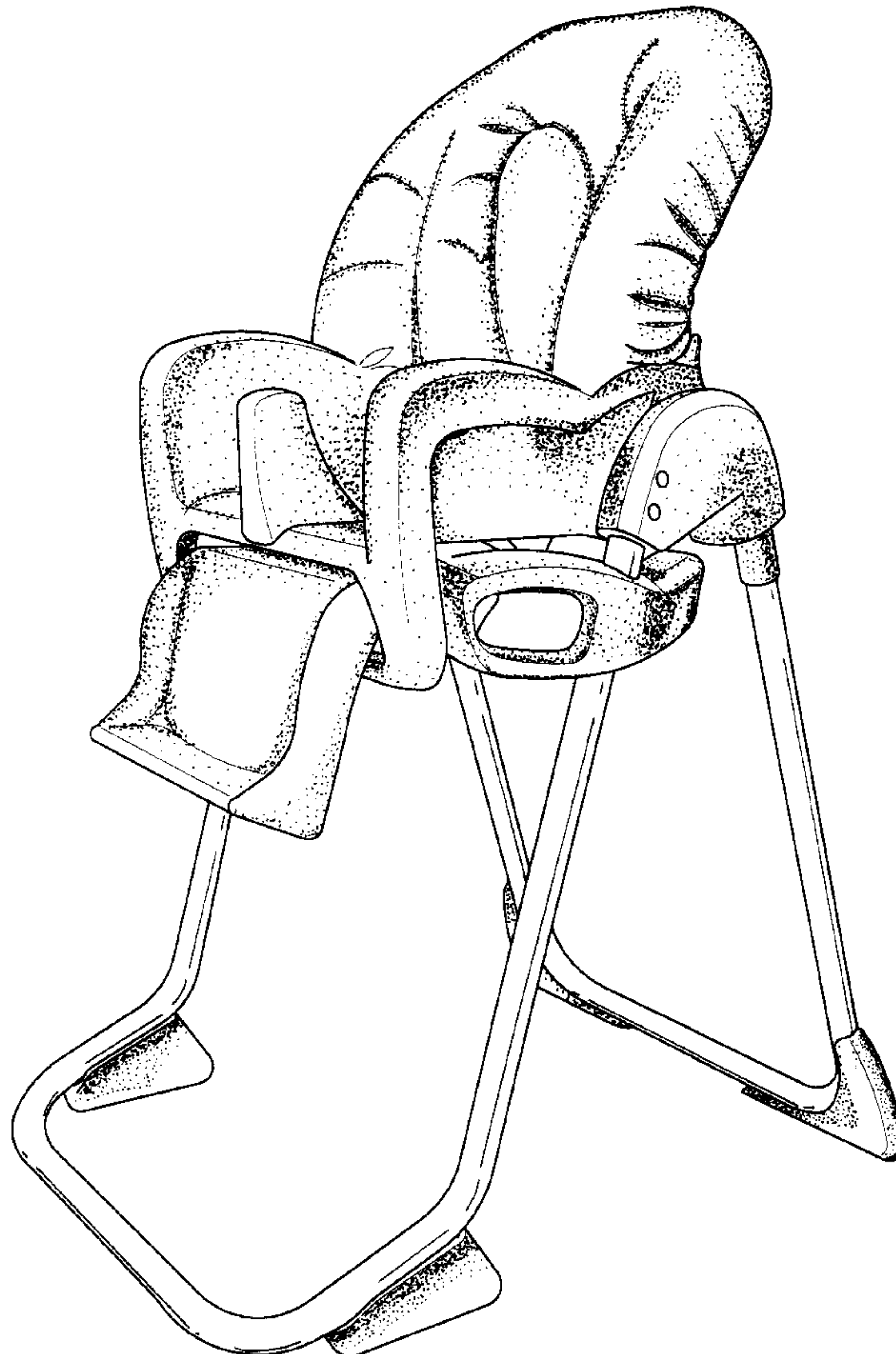

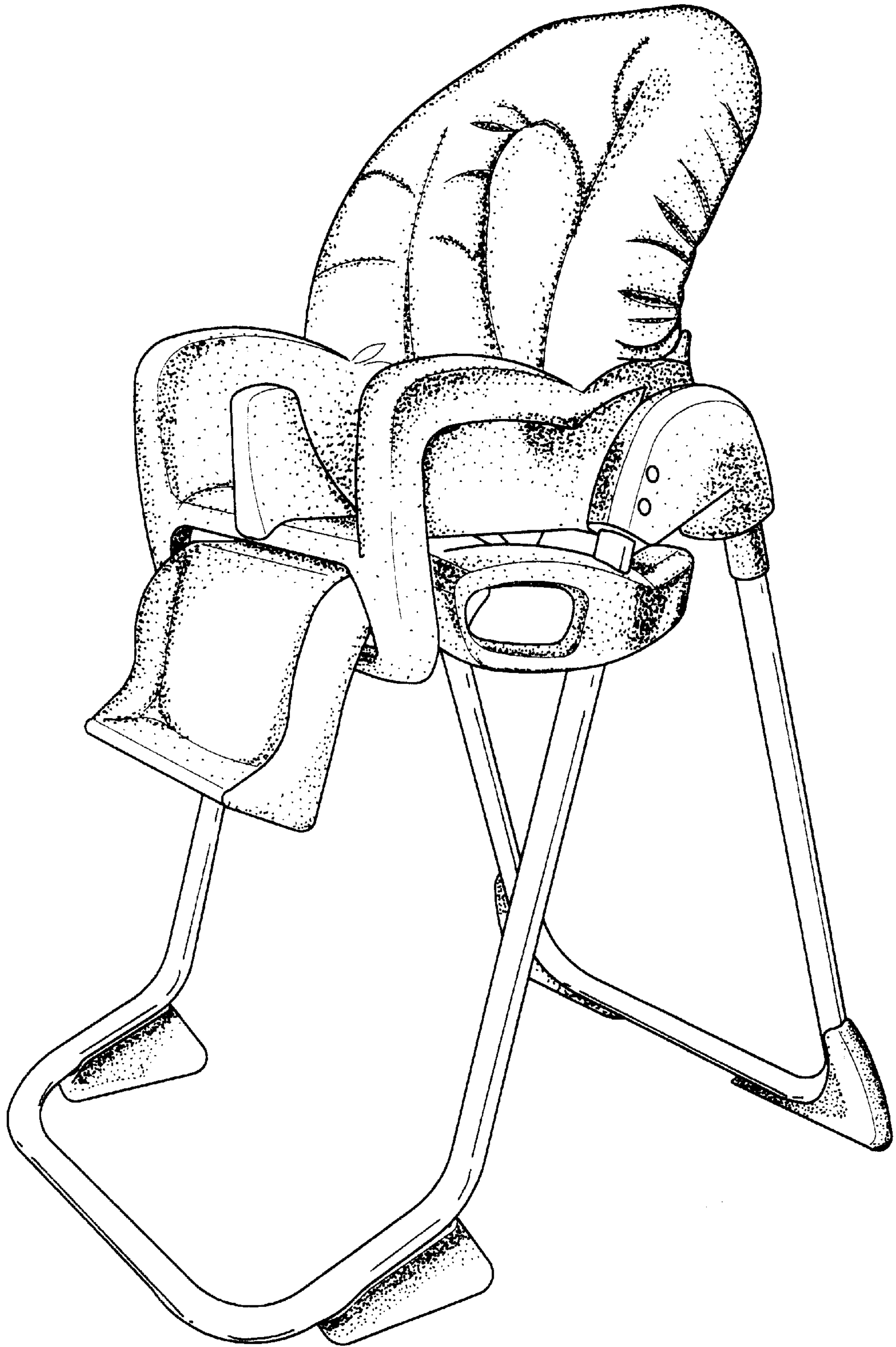

FIG. 1

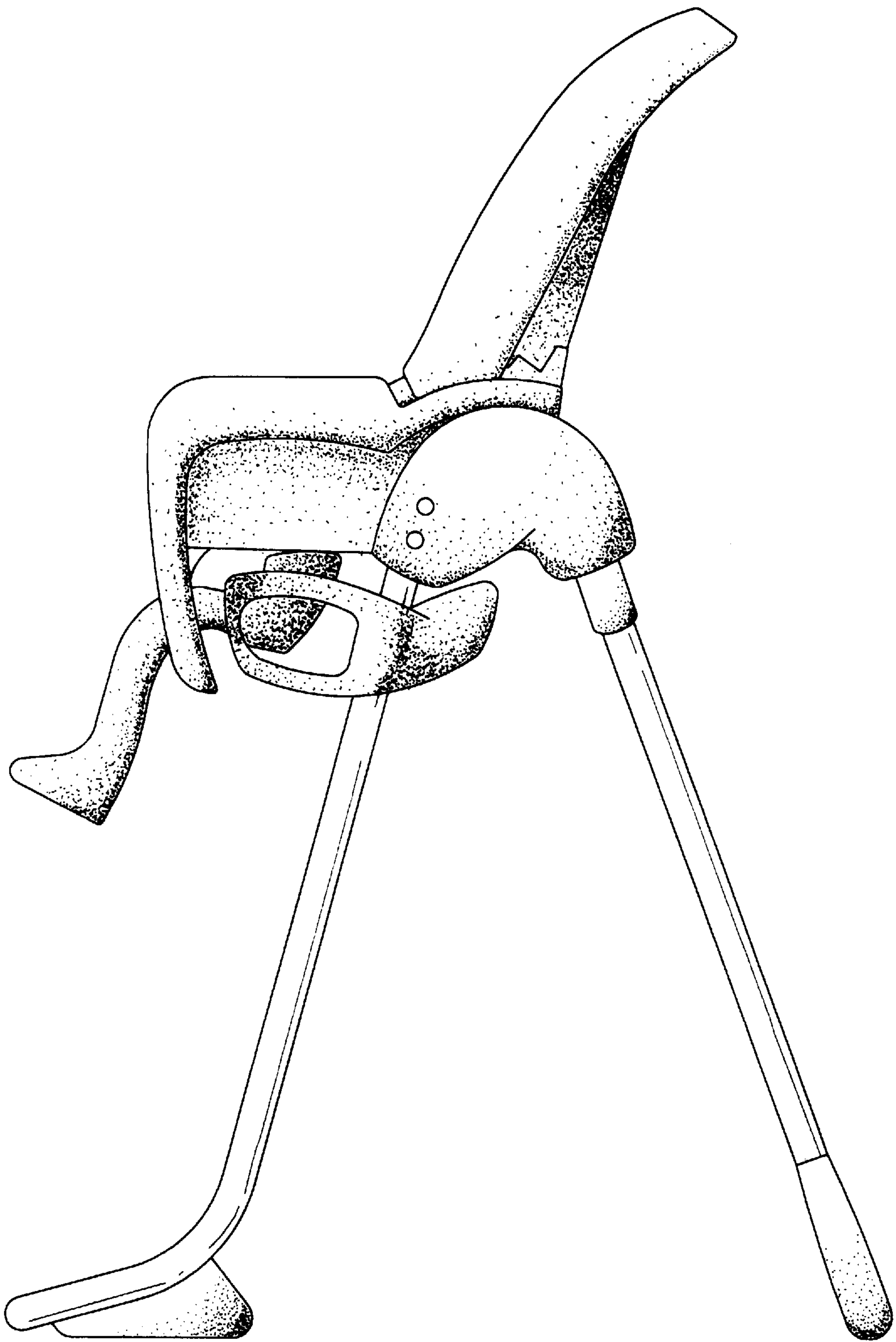

FIG. 2

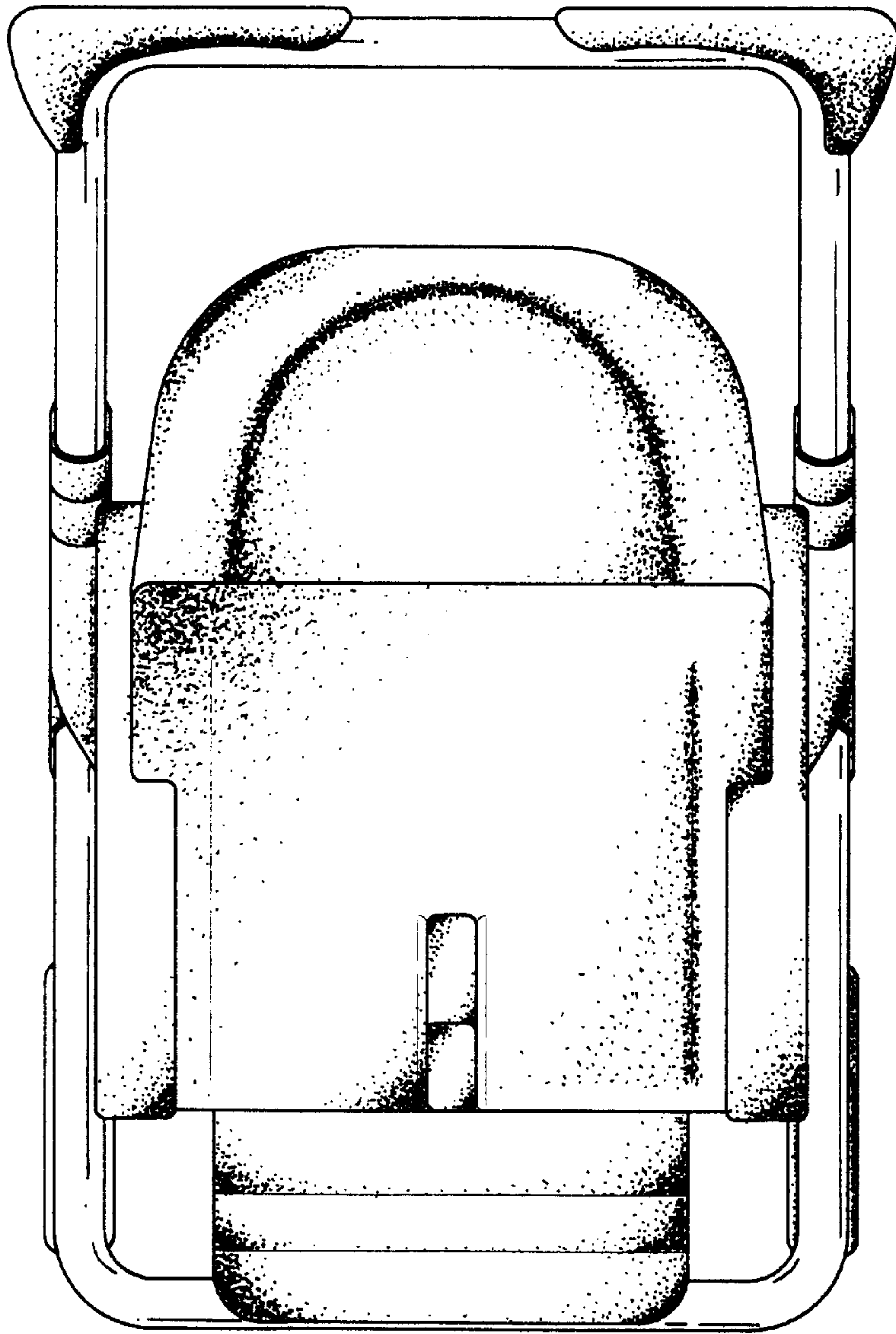

FIG. 3

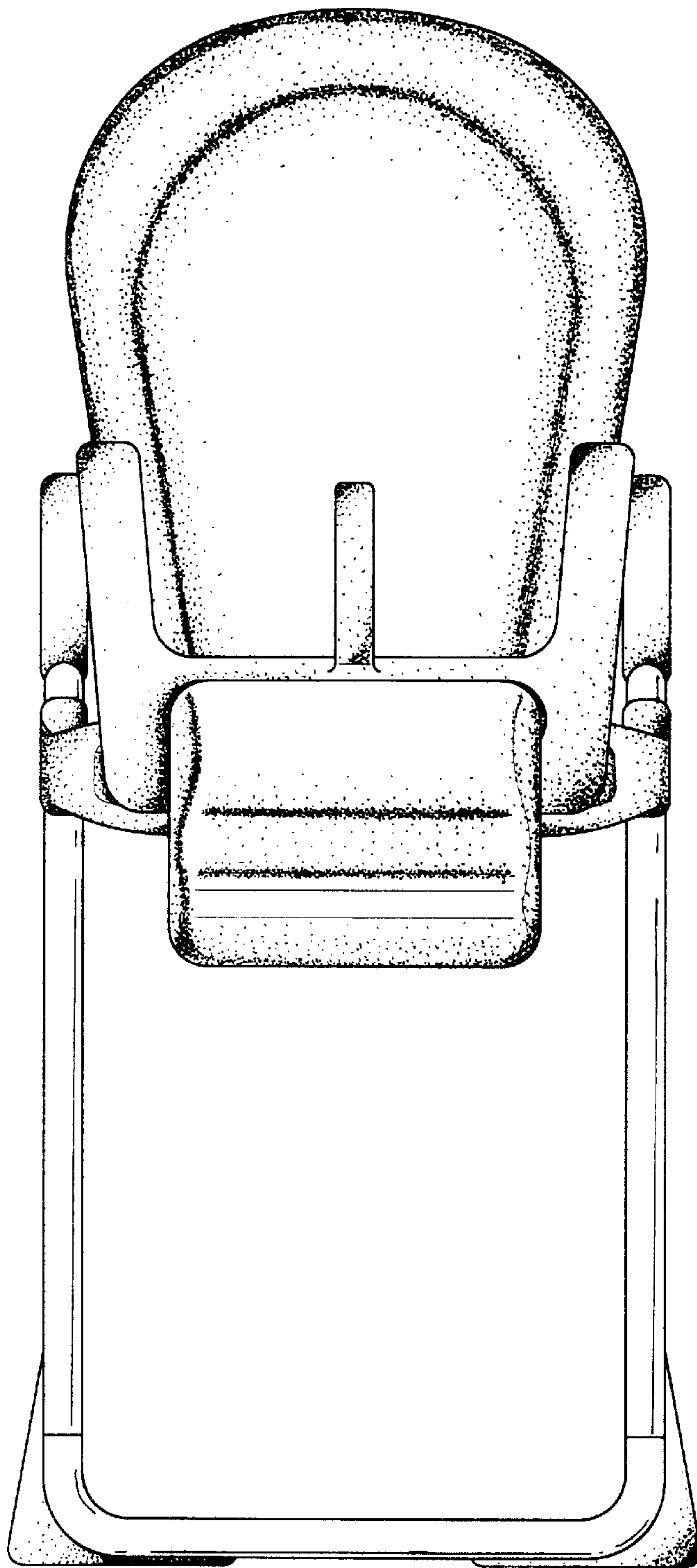

FIG. 4

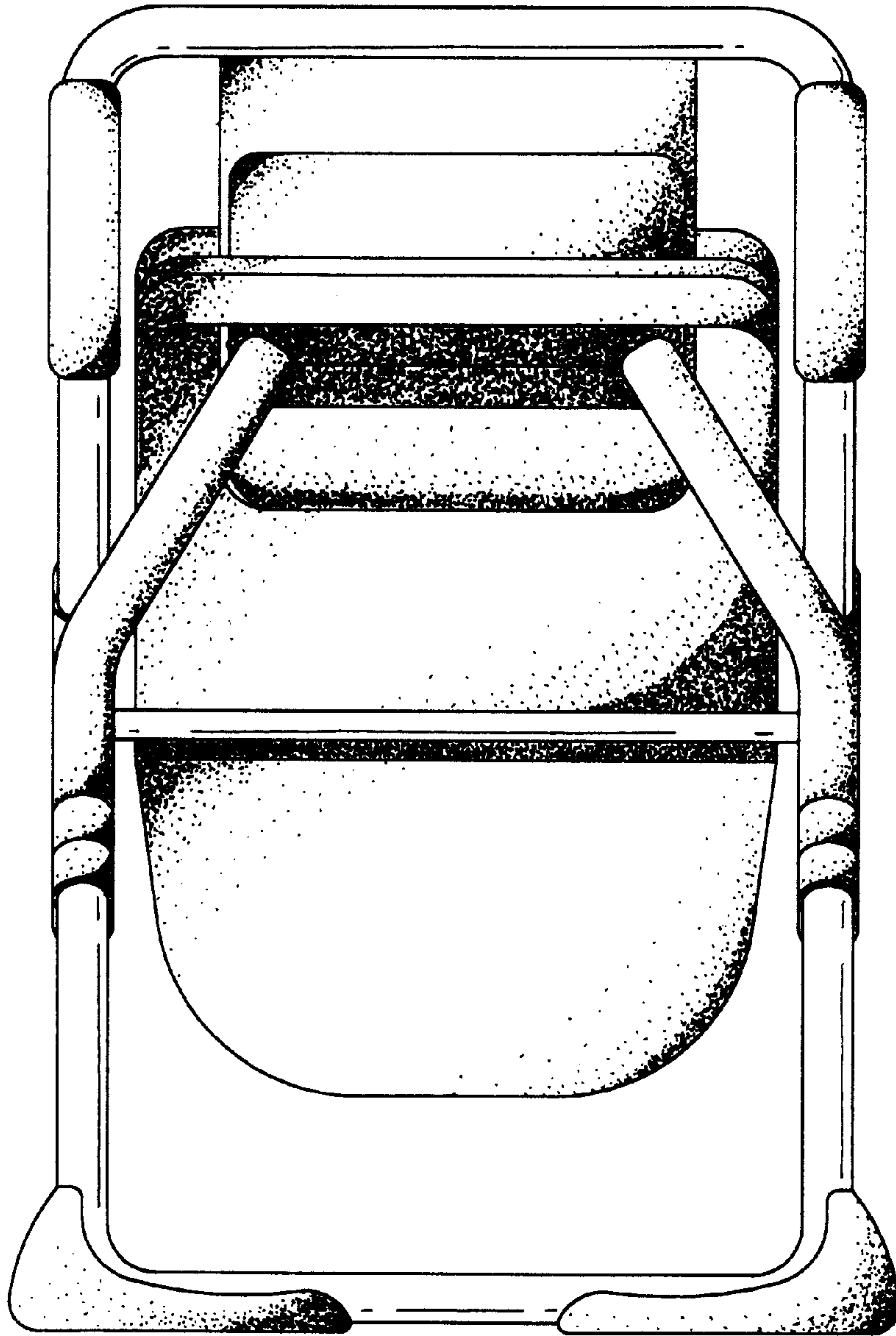

FIG. 5

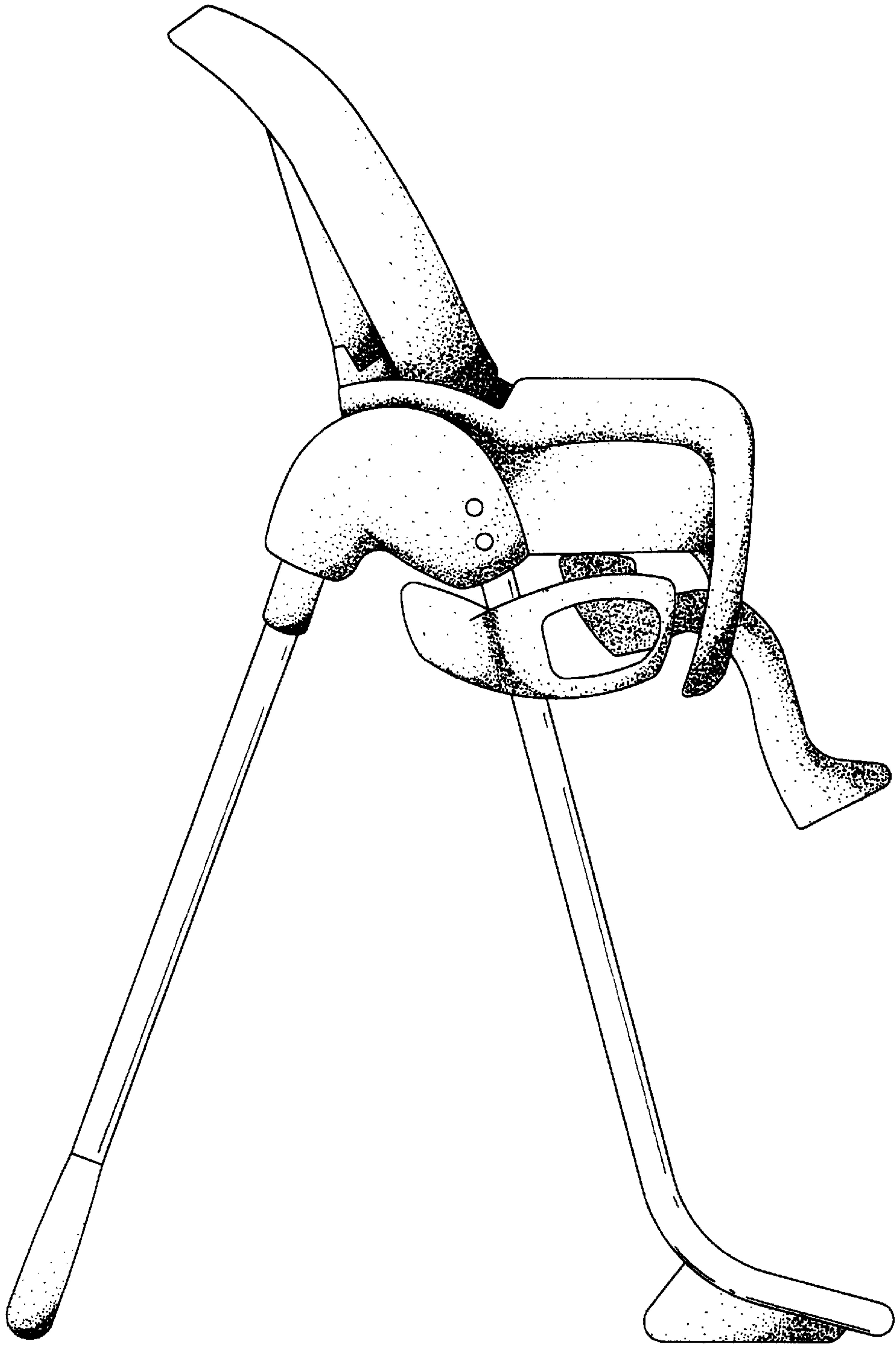

FIG. 6

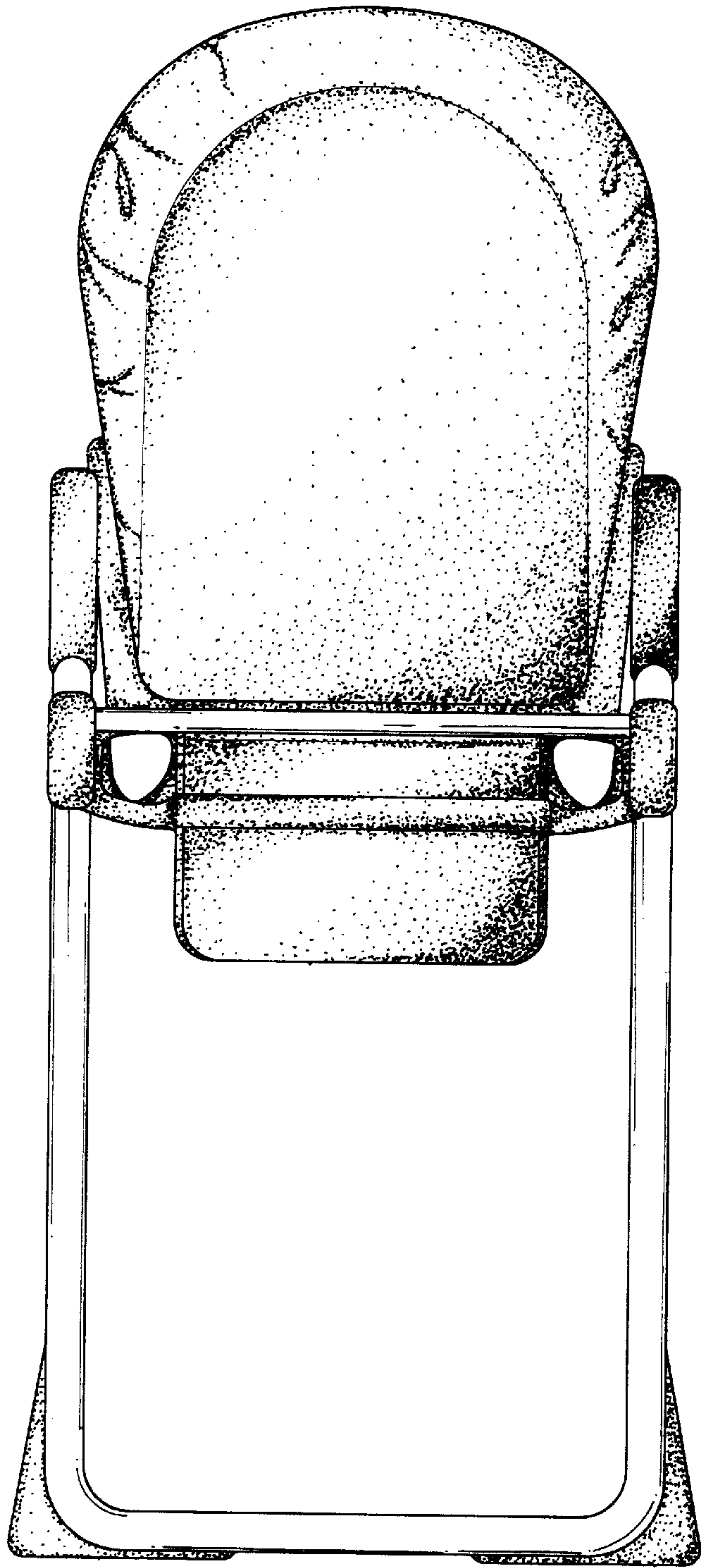

FIG. 7