



US00D451674B1

(12) **United States Design Patent**  
**Leins**

(10) **Patent No.:** **US D451,674 S**

(45) **Date of Patent:** **\*\* Dec. 11, 2001**

(54) **CASE FOR A HANDTOOL, ESPECIALLY FOR OFFICE WORK**

(75) Inventor: **Hanspeter Leins**, Nagold (DE)

(73) Assignee: **C Tech AG**, Chur (CH)

(\*\*) Term: **14 Years**

(21) Appl. No.: **29/135,320**

(22) Filed: **Jan. 9, 2001**

(30) **Foreign Application Priority Data**

Jul. 10, 2000 (XH) ..... DM/052 776

(51) **LOC (7) Cl.** ..... **03-01**

(52) **U.S. Cl.** ..... **D3/301; D3/206**

(58) **Field of Search** ..... D3/203, 205, 201,  
D3/232, 233, 273, 289, 301, 303, 206;  
206/581, 370, 440; 150/131, 132, 150,  
161

(56) **References Cited**

**U.S. PATENT DOCUMENTS**

D. 259,596	*	6/1981	Gray	.....	D3/205
D. 262,585	*	1/1982	Anema	.....	D3/205
D. 316,932	*	5/1991	Escher, Jr.	.....	D3/294
D. 380,900	*	7/1997	Pearson et al.	.....	D3/294
D. 407,432	*	3/1999	Tell	.....	D3/301
D. 409,385	*	5/1999	Pearson et al.	.....	D3/301
D. 414,935	*	10/1999	Bould	.....	D3/301
D. 427,764	*	7/2000	Conway	.....	D3/203
D. 430,393	*	9/2000	Conway	.....	D3/203
D. 434,796	*	12/2000	Coleman	.....	D19/27

\* cited by examiner

*Primary Examiner*—Philip S. Hyder

(74) *Attorney, Agent, or Firm*—Brinks Hofer Gilson & Lione

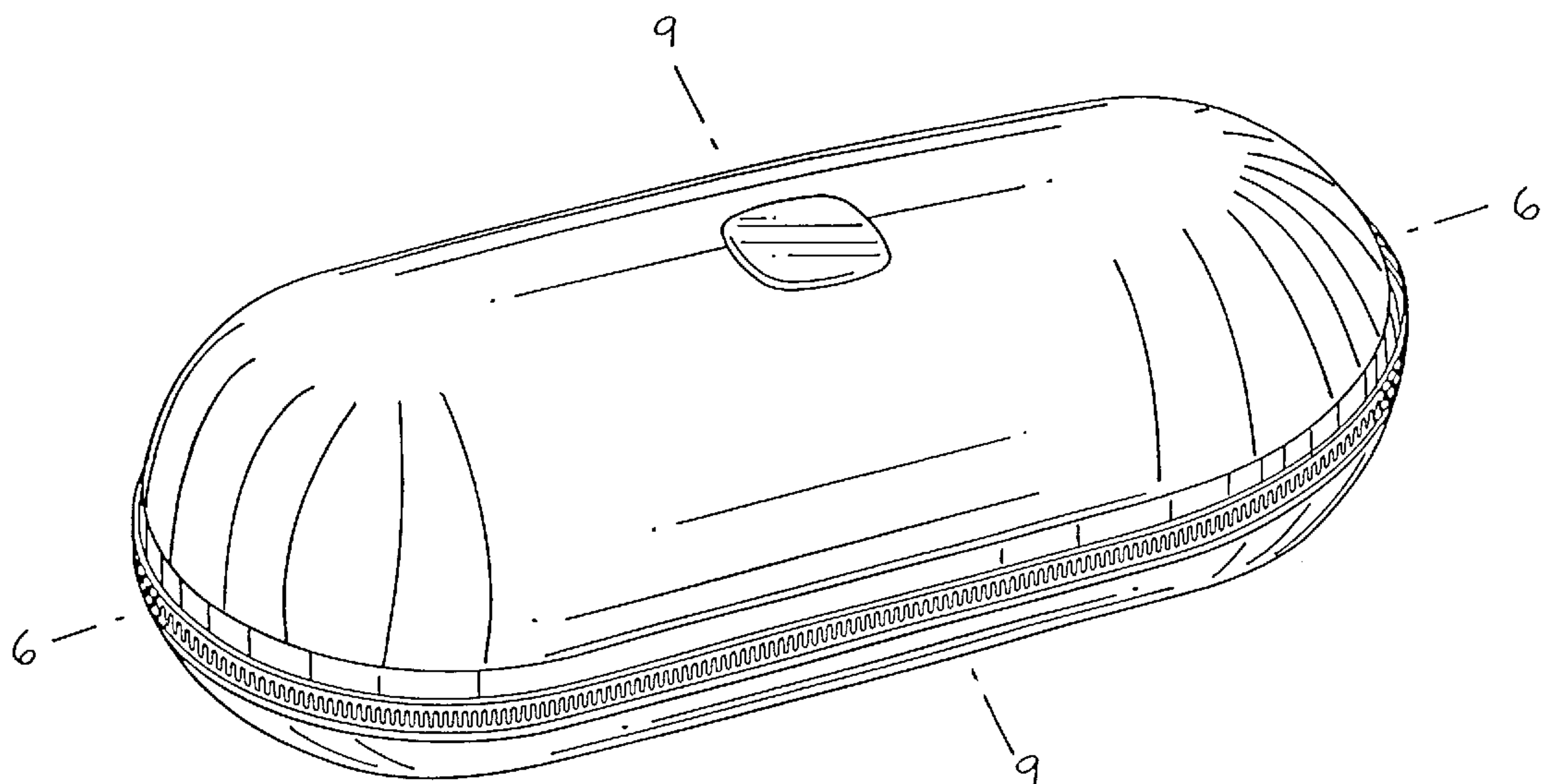
(57) **CLAIM**

The ornamental design for a case for a handtool, especially for office work, as shown.

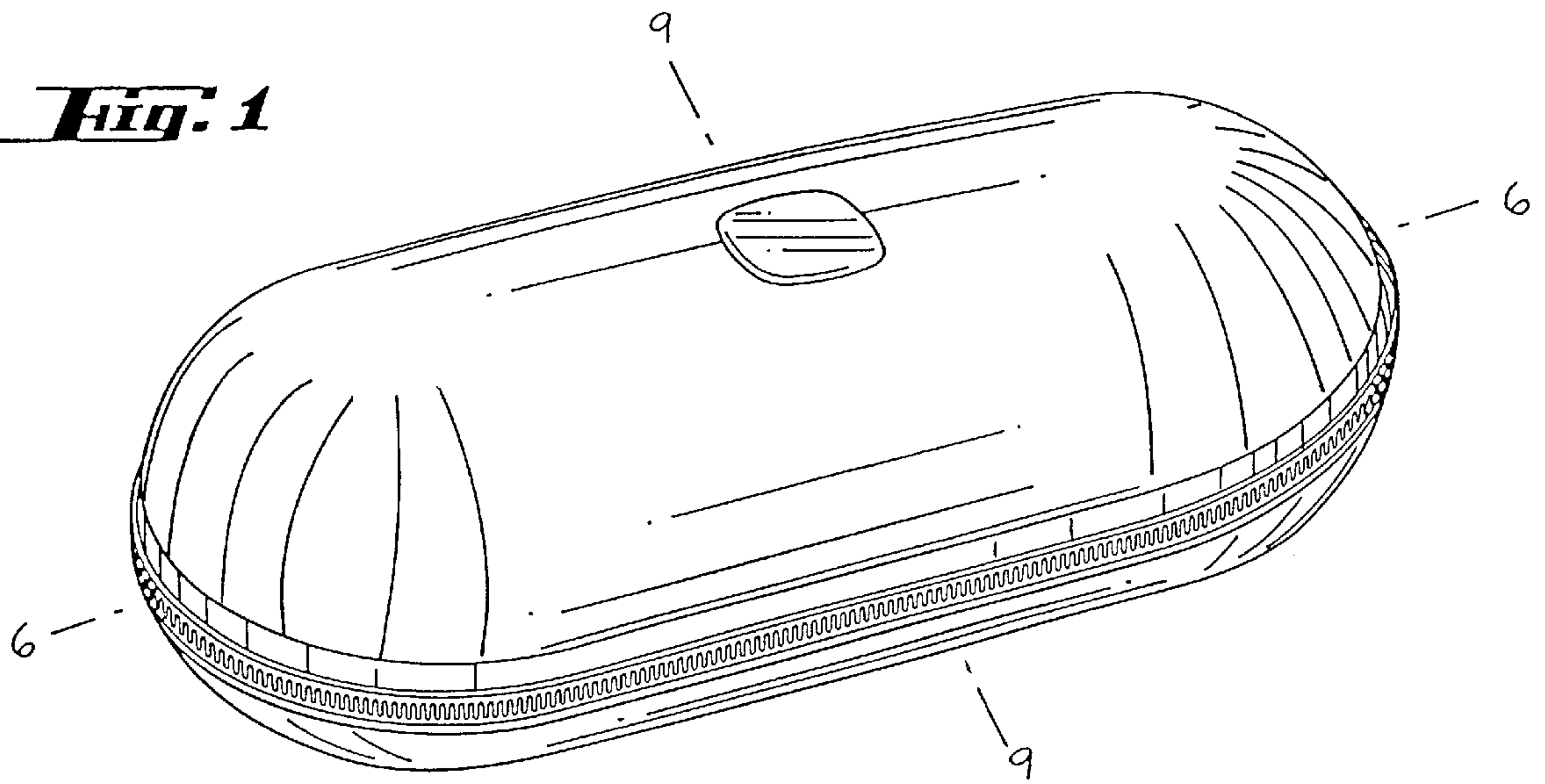
**DESCRIPTION**

FIG. 1 is a first perspective view from above and from one side of a first variant;  
 FIG. 2 is a second perspective view from above and from the other side of the first variant;  
 FIG. 3 is a perspective view of the first variant in open state;  
 FIG. 4 is a front elevational view of the first variant;  
 FIG. 5 is a rear elevational view of the first variant;  
 FIG. 6 is a cross-sectional view taken along the line 6—6 of FIG. 1;  
 FIG. 7 is a right side elevational view of the first variant;  
 FIG. 8 is a left side elevational view of the first variant;  
 FIG. 9 is a cross-sectional view taken along the line 9—9 of FIG. 1;  
 FIG. 10 is a top plan view of the first variant;  
 FIG. 11 is a bottom plan view;  
 FIG. 12 is a first perspective view from above and from one side of a second variant;  
 FIG. 13 is a second perspective view from above and from the other side of the second variant;  
 FIG. 14 is a perspective view of the second variant in open state;  
 FIG. 15 is a front elevational view of the second variant;  
 FIG. 16 is a rear elevational view of the second variant;  
 FIG. 17 is a cross-sectional view taken along line 17—17 of FIG. 12;  
 FIG. 18 is a right side elevational view of the second variant;  
 FIG. 19 is a left side elevational view of the second variant;  
 FIG. 20 is a cross-sectional view taken along line 20—20 of FIG. 12;  
 FIG. 21 is a top plan view of the second variant; and,  
 FIG. 22 is a bottom plan view.

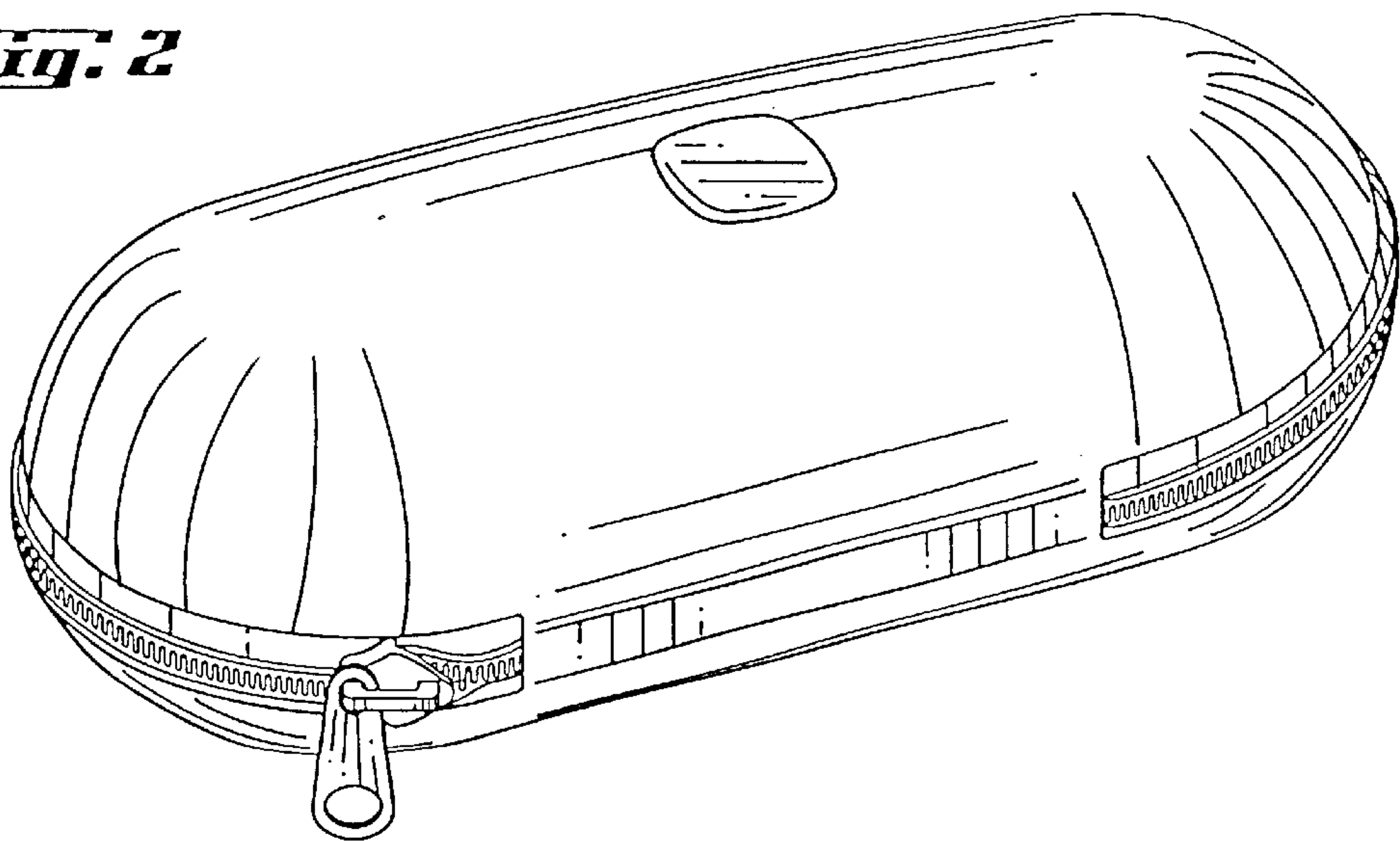
**1 Claim, 10 Drawing Sheets**



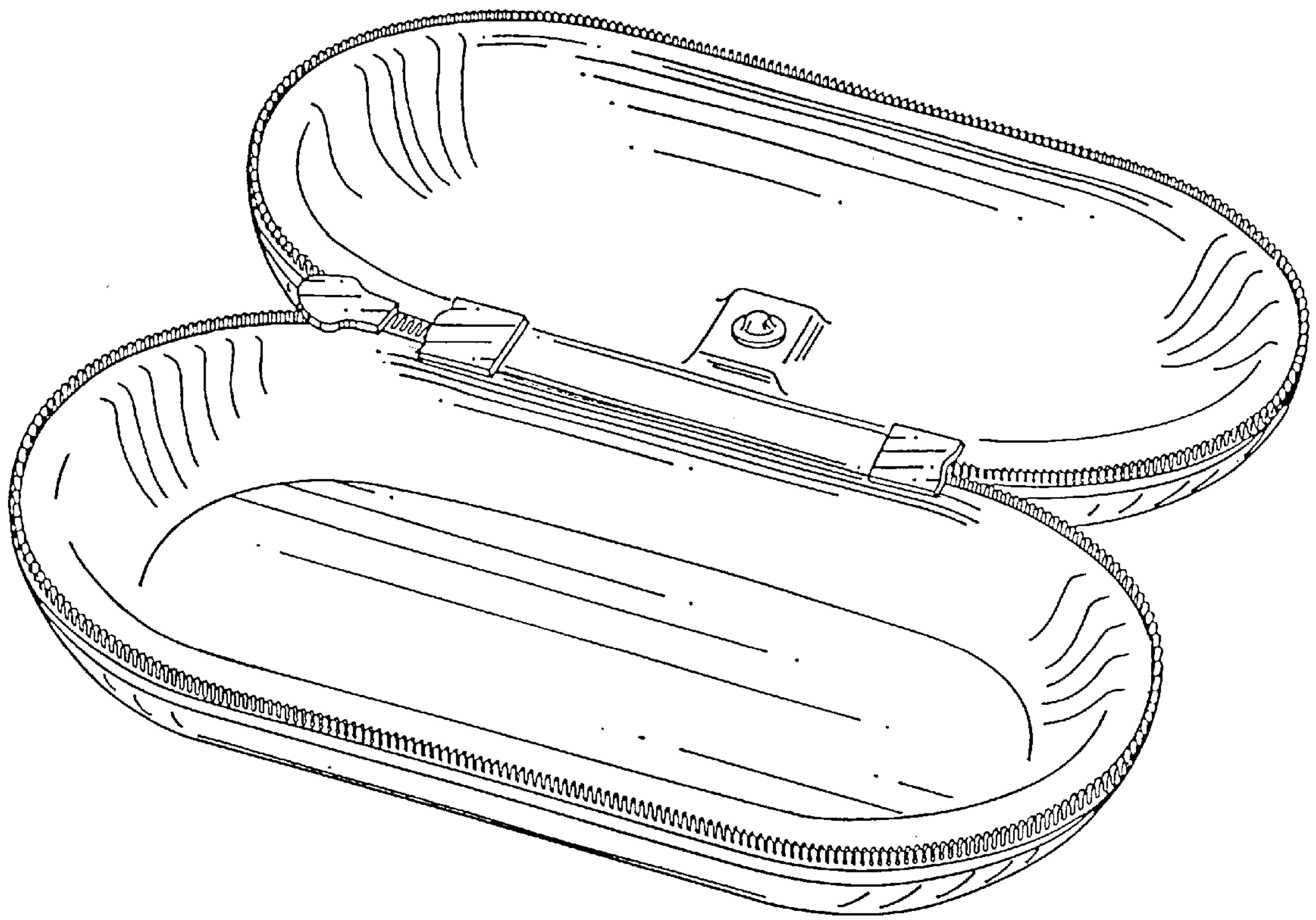
**Fig. 1**



**Fig. 2**

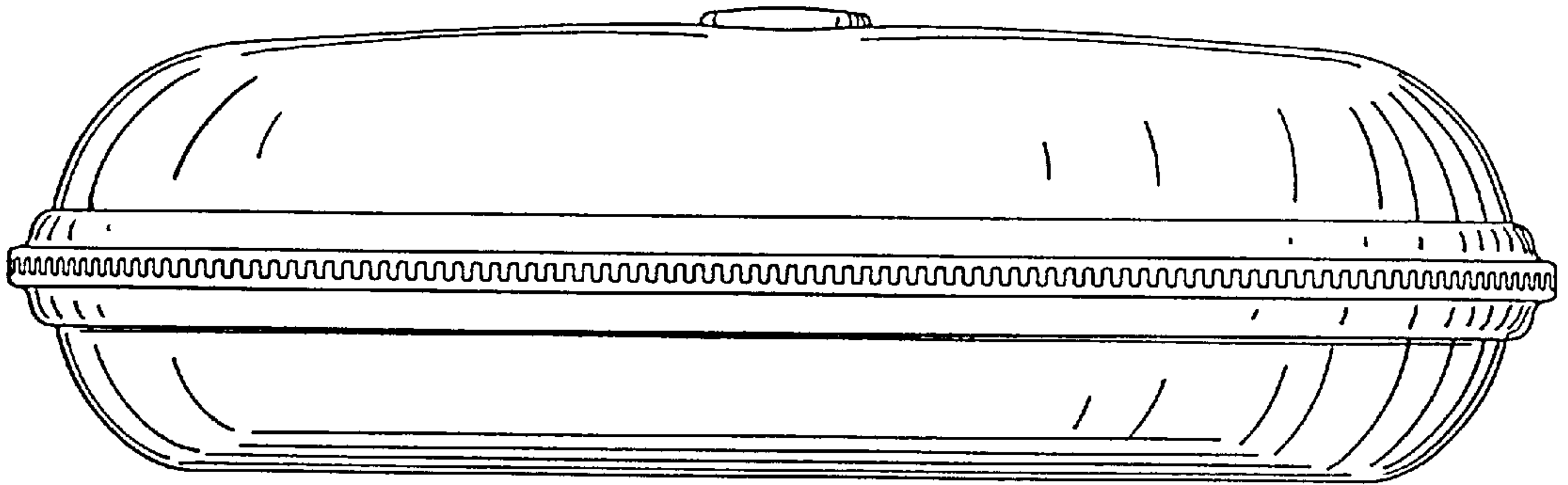


***Fig. 3***

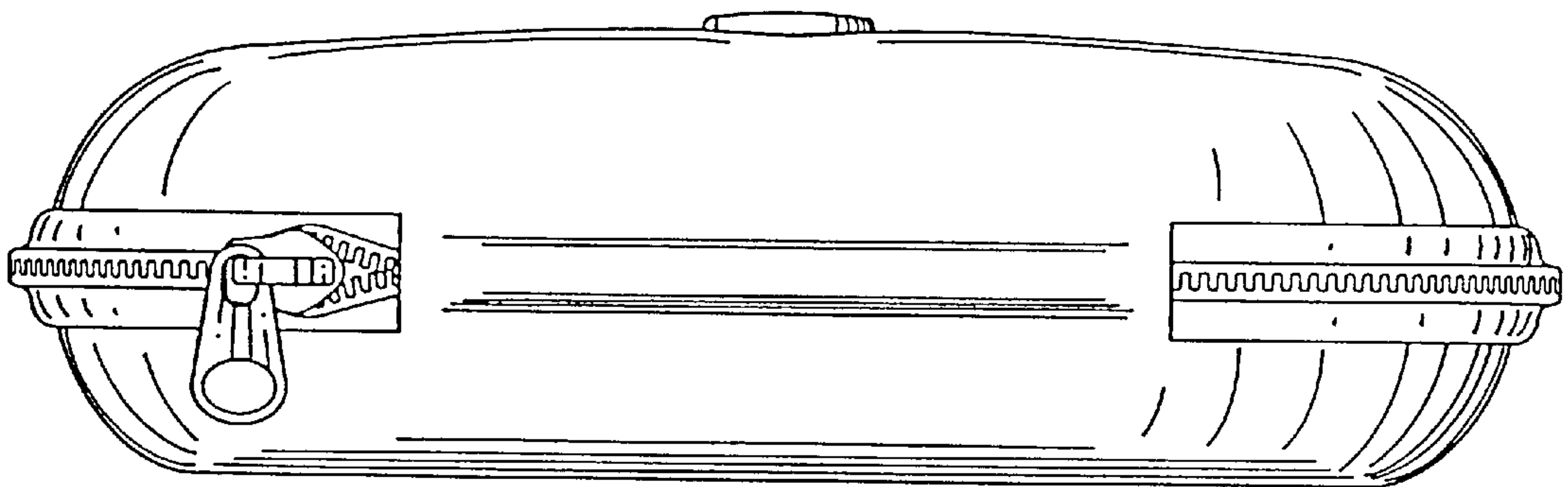




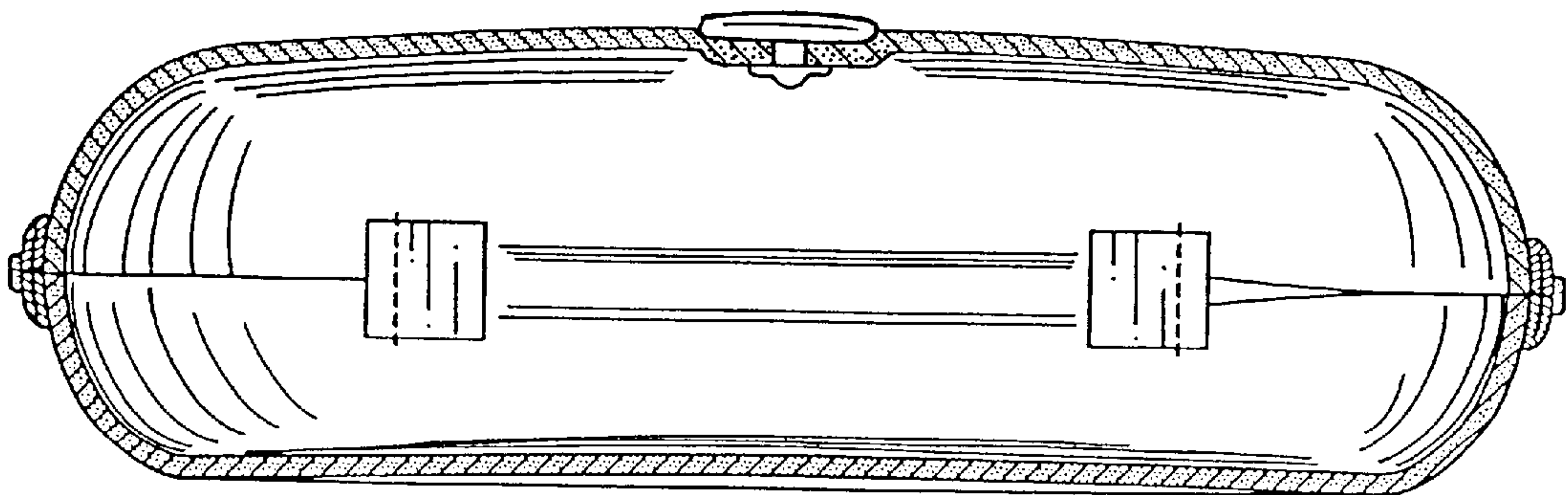
**Fig. 4**



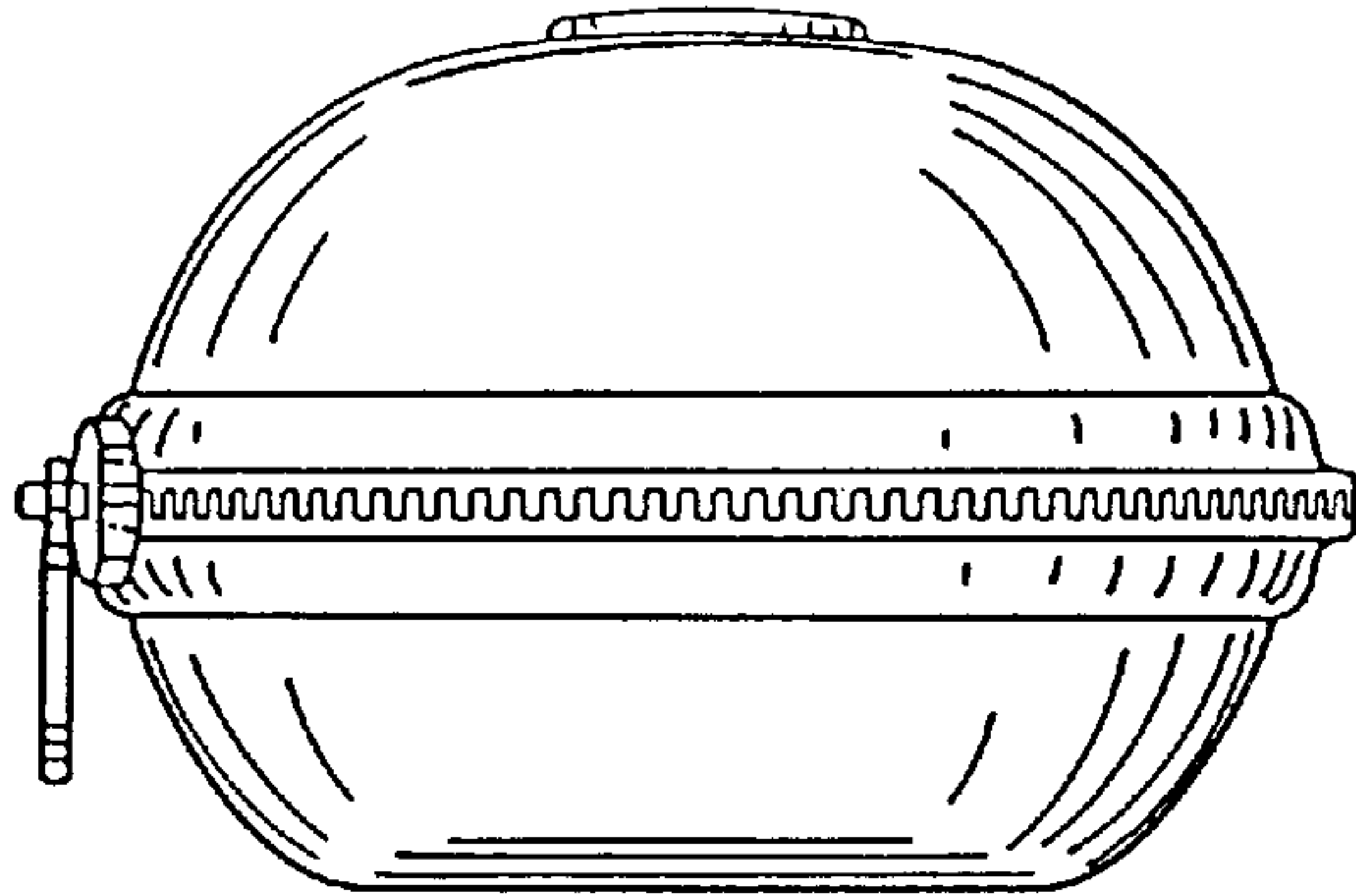
**Fig. 5**



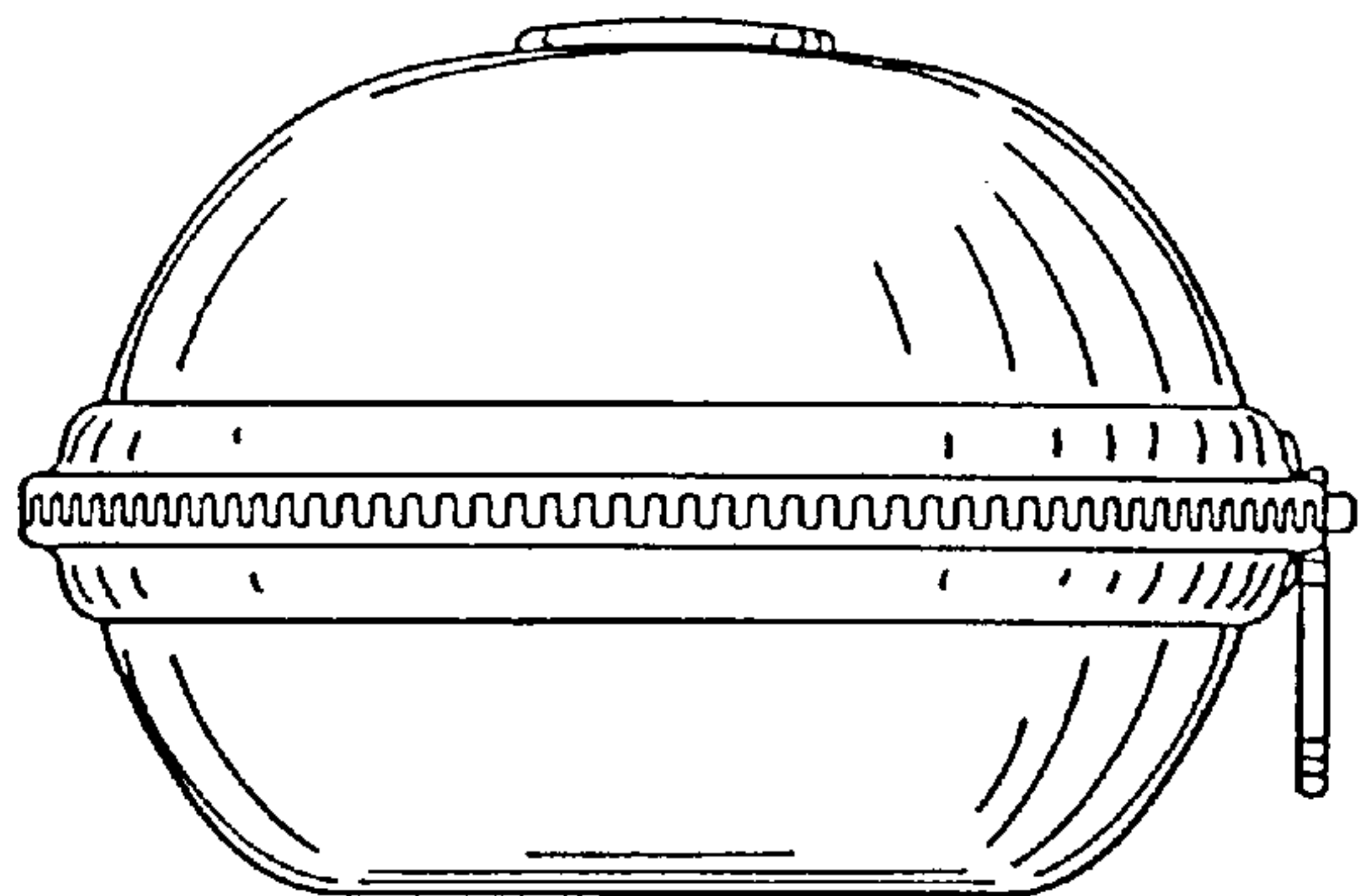
**Fig. 6**



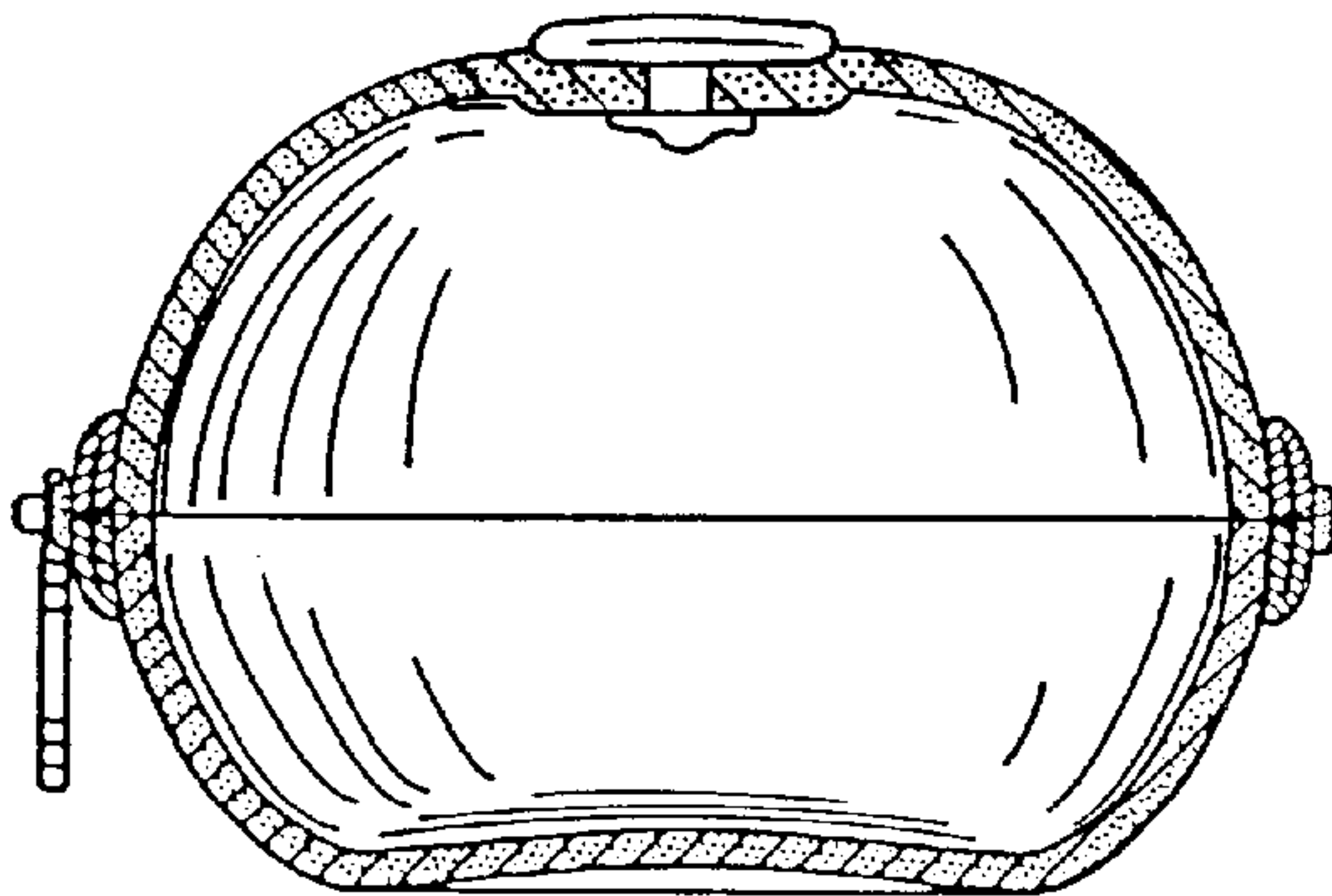
***Fig. 7***



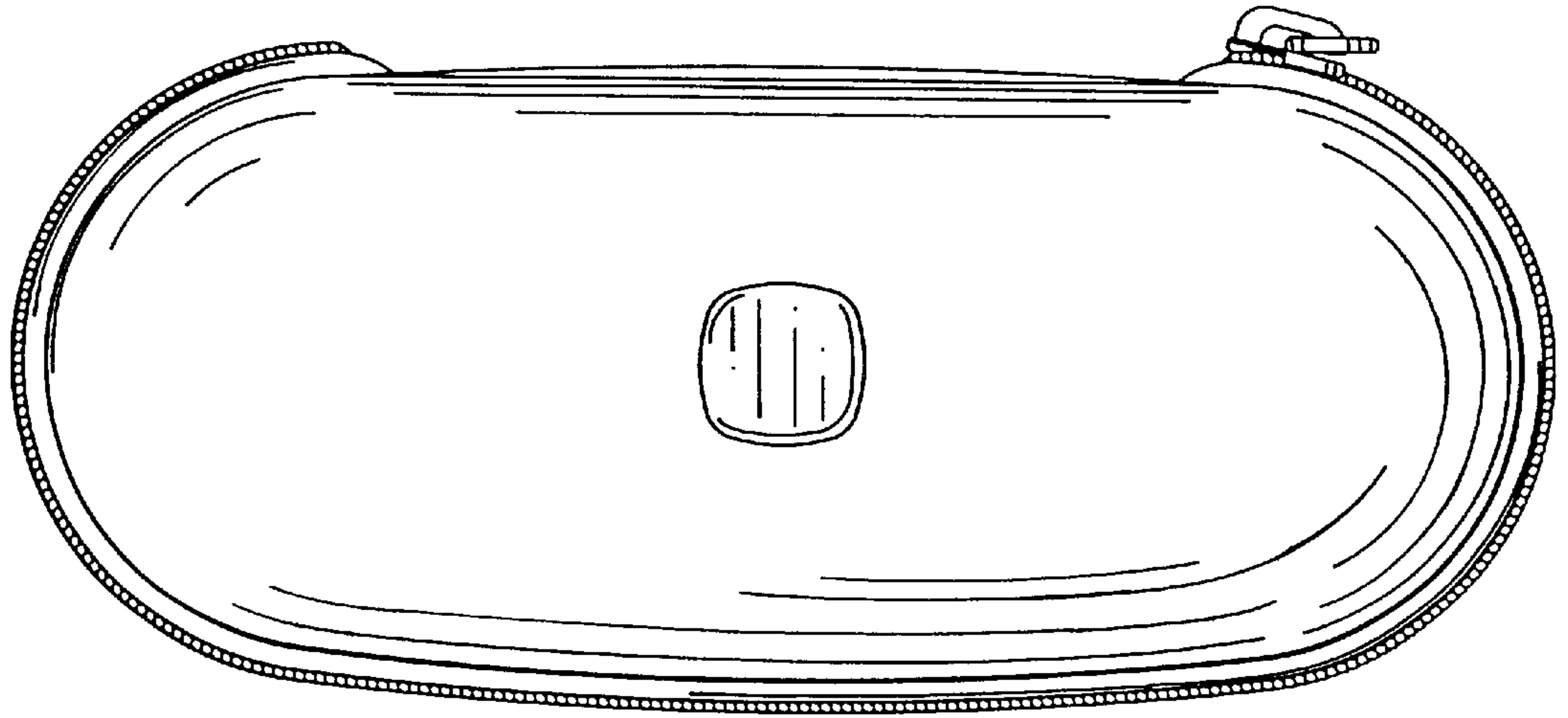
***Fig. 8***



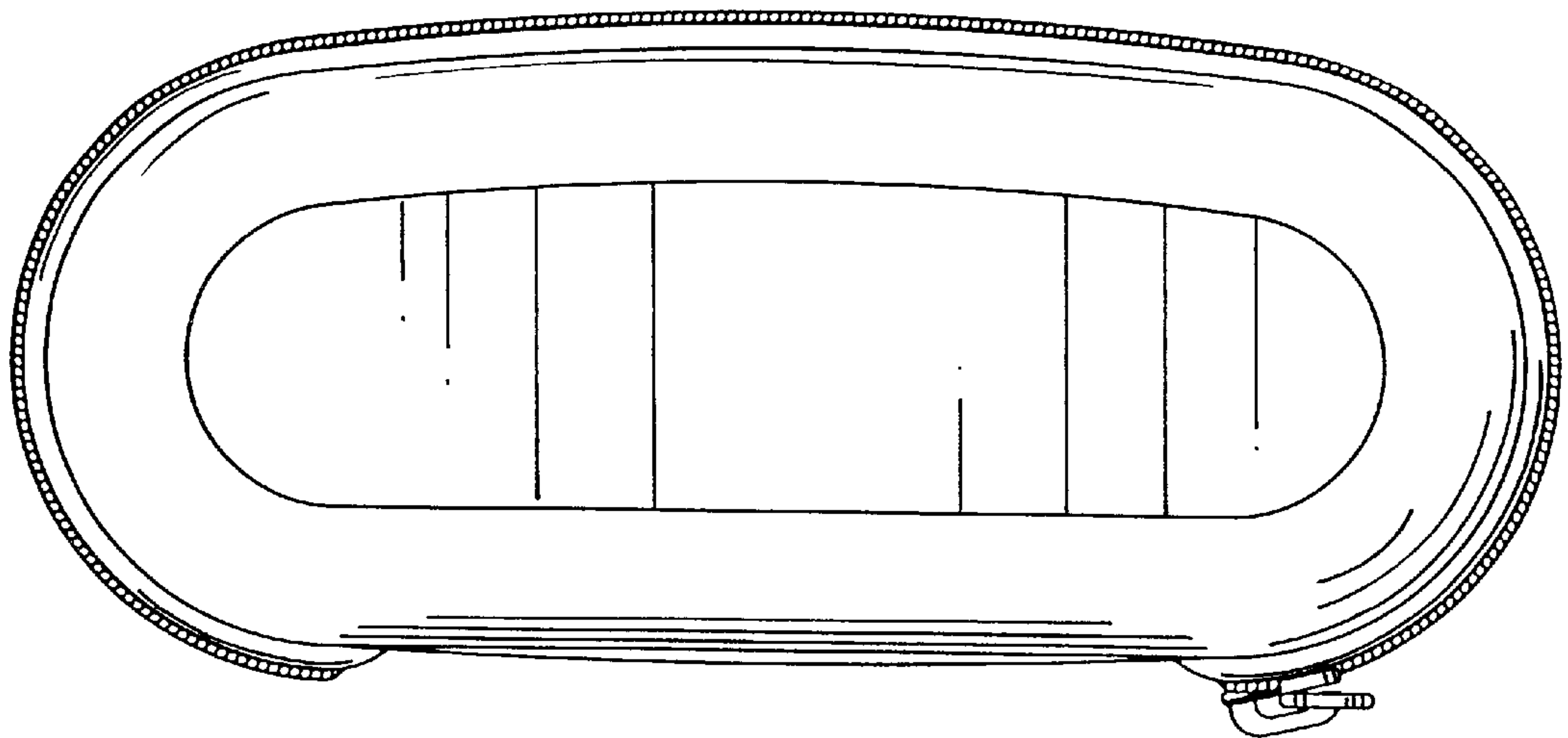
***Fig. 9***



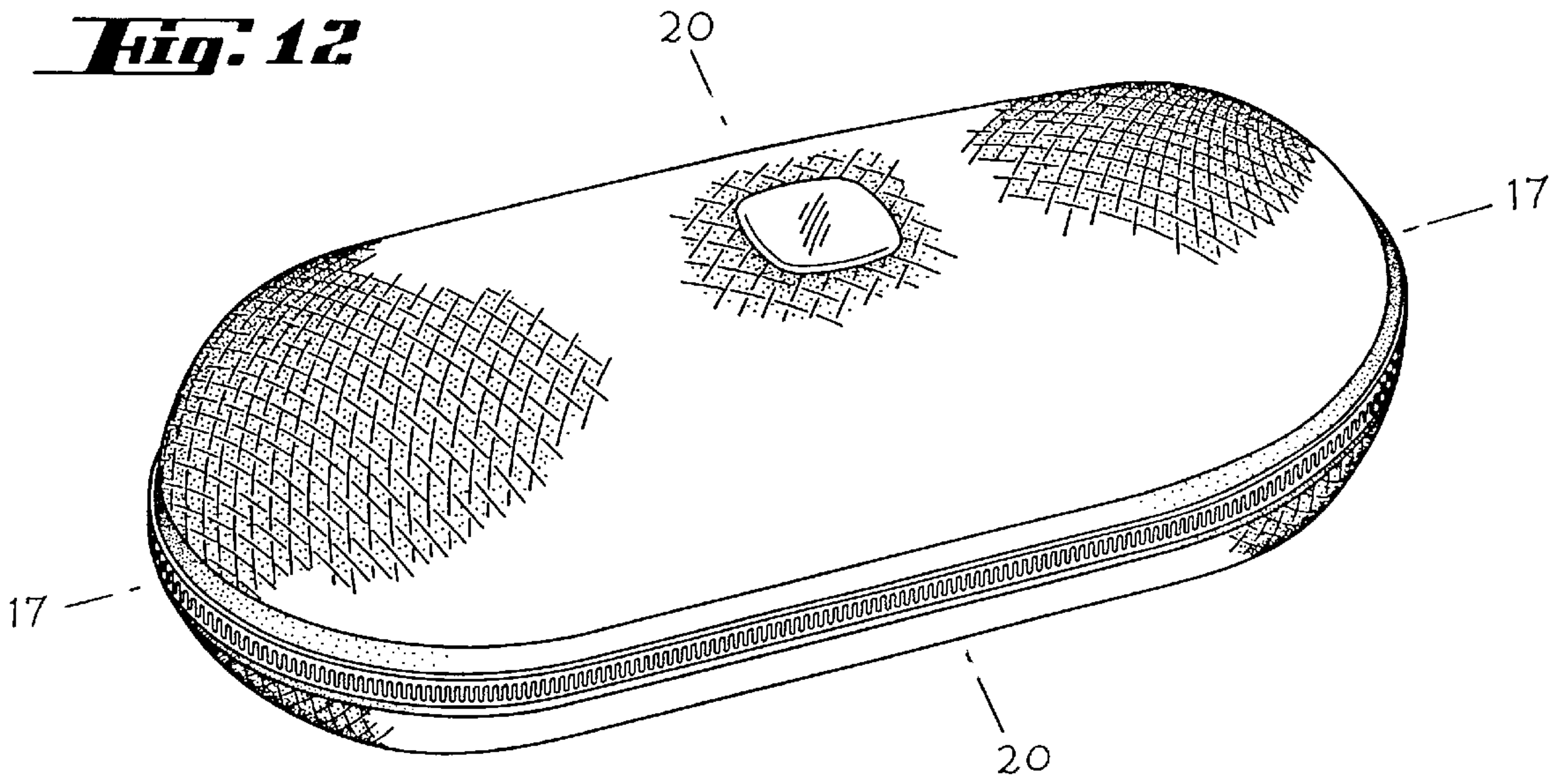
***Fig. 10***



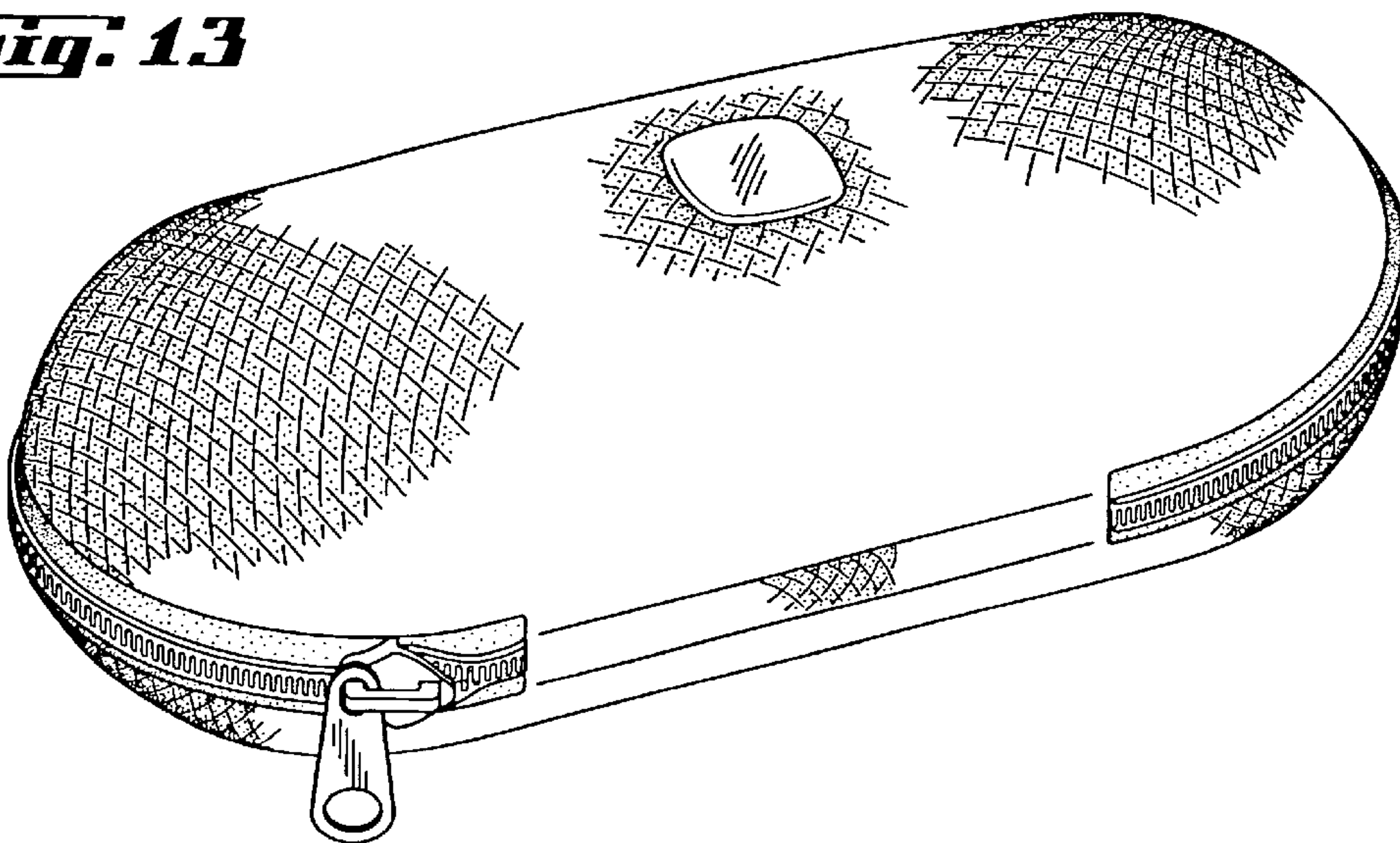
***Fig. 11***



**Fig. 12**

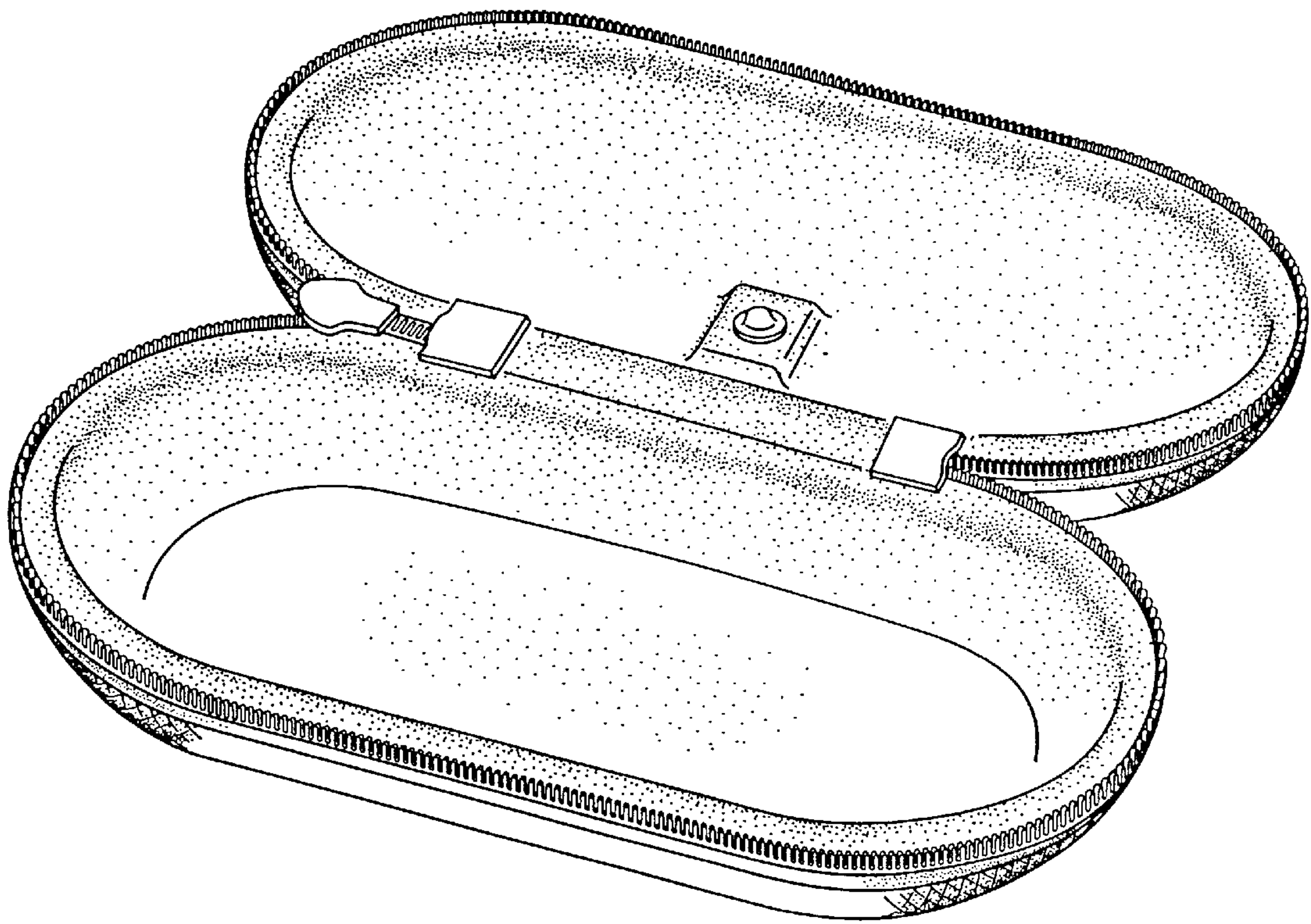


**Fig. 13**



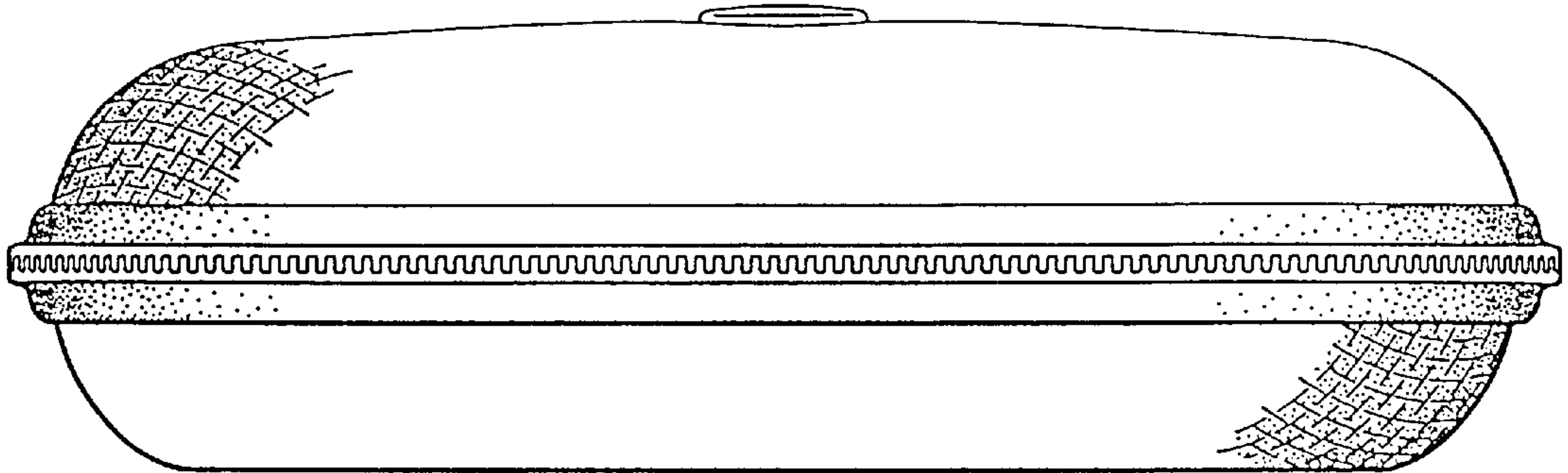


***Fig. 14***

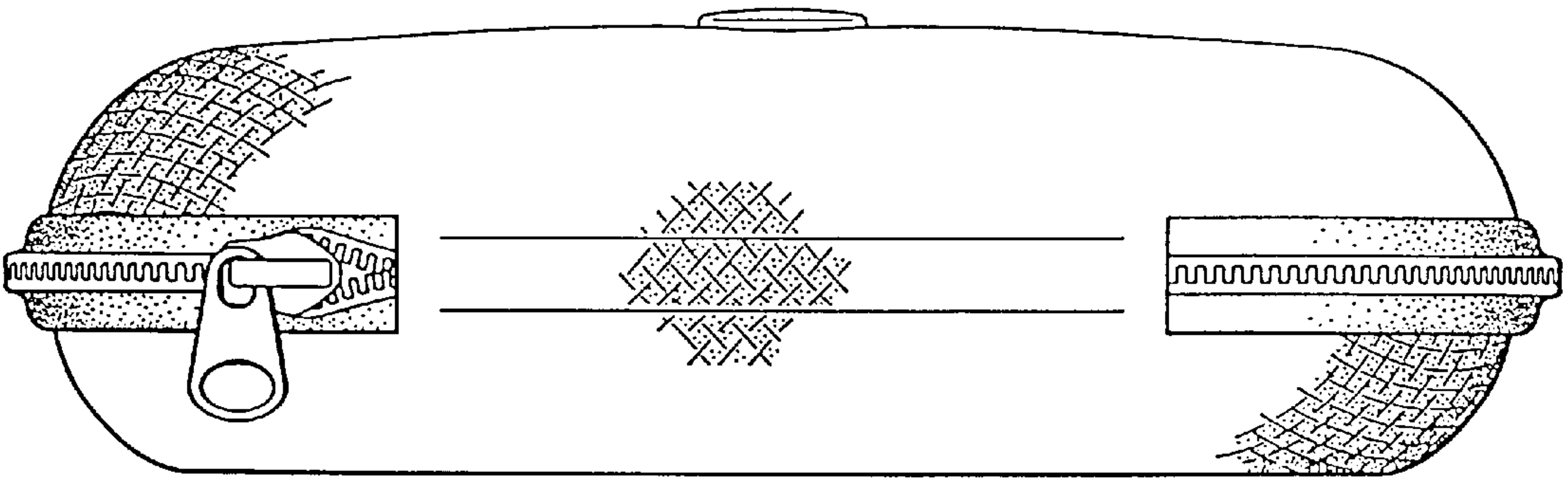




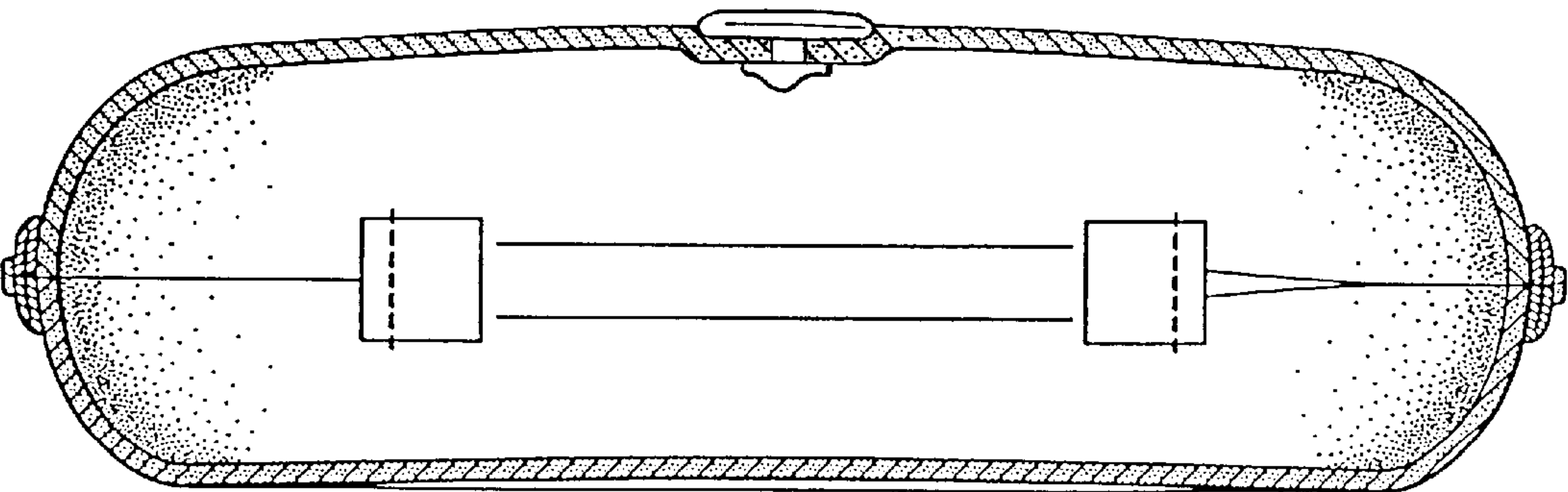
***Fig. 15***



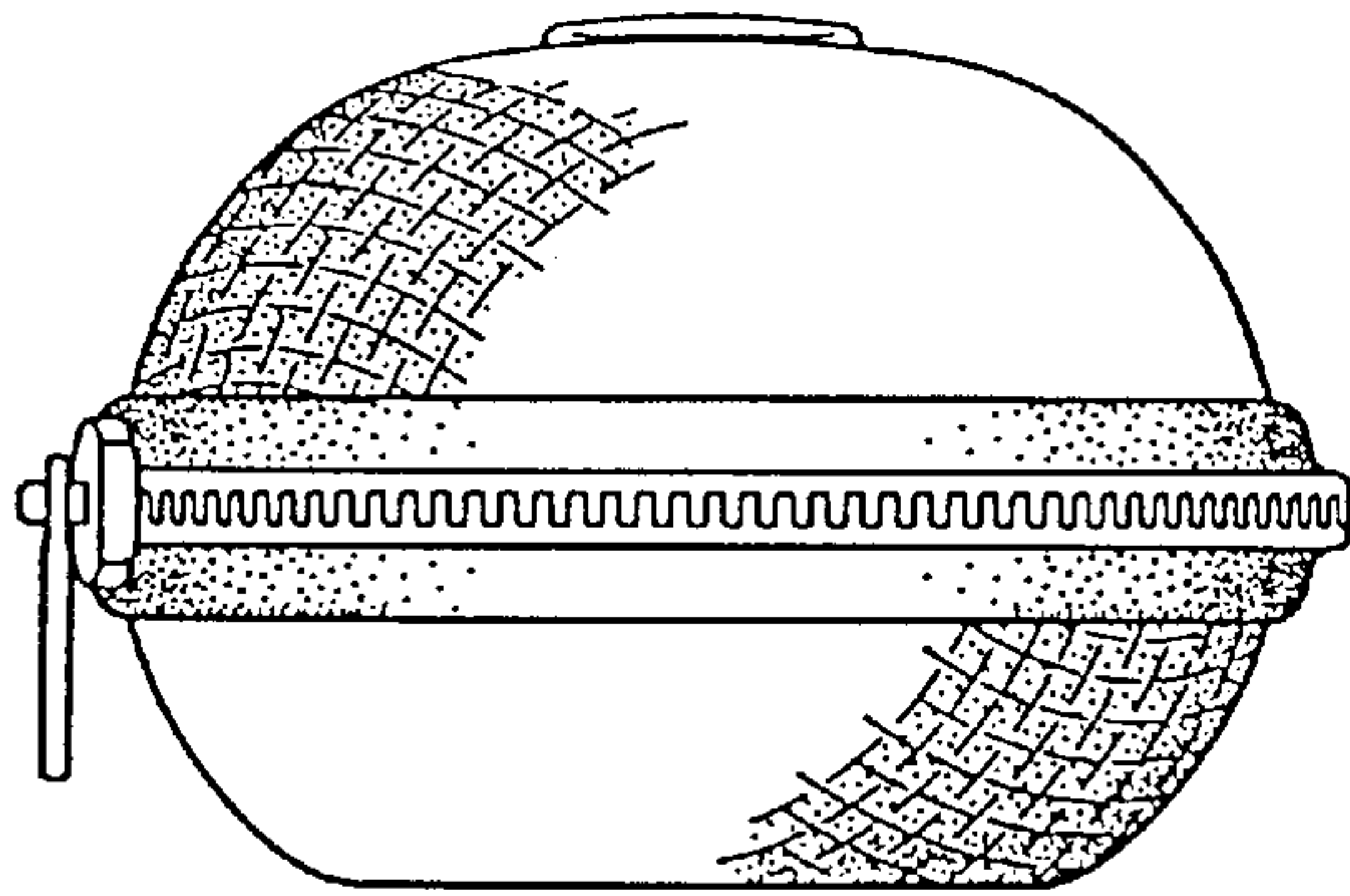
***Fig. 16***



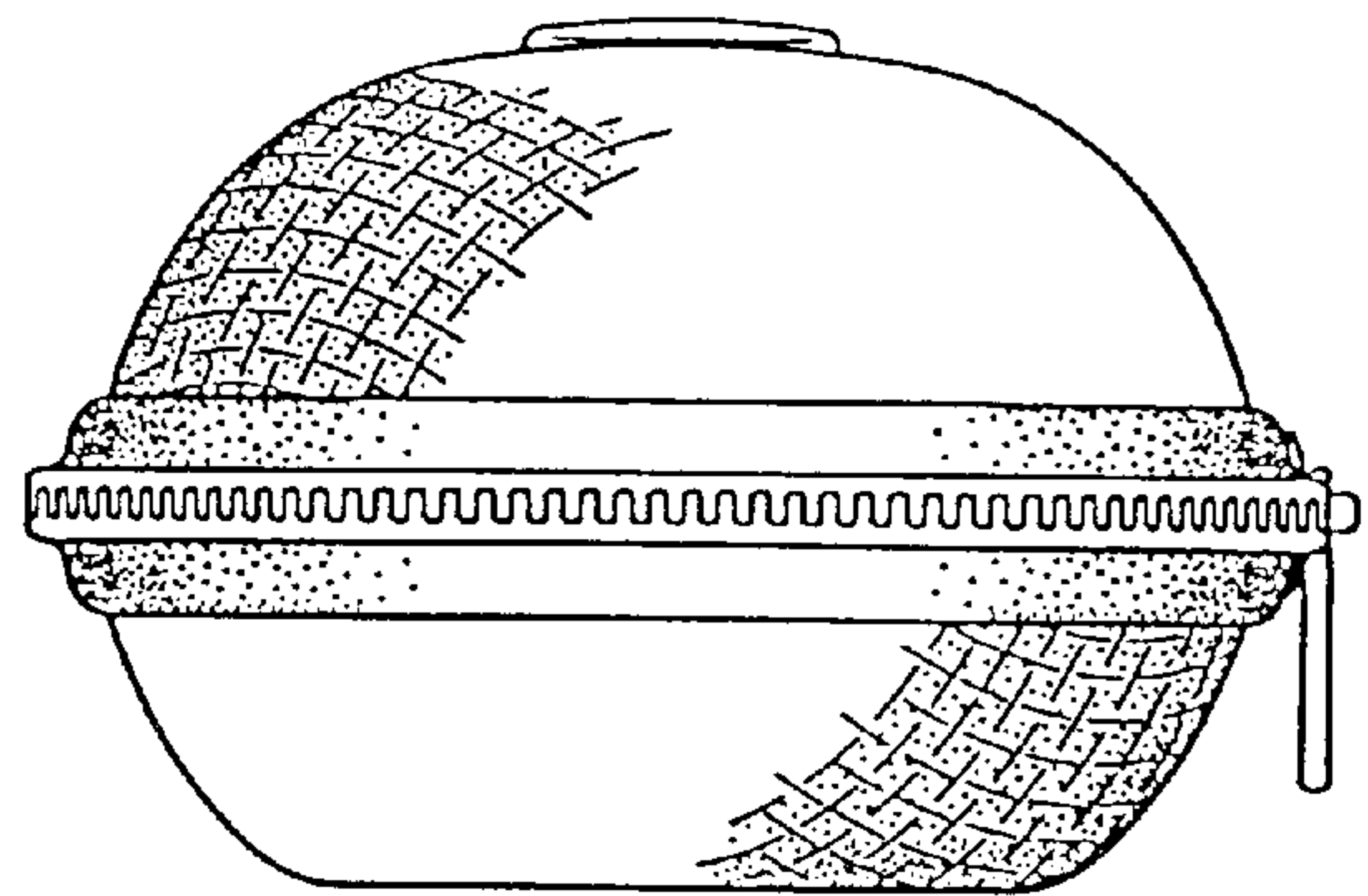
***Fig. 17***



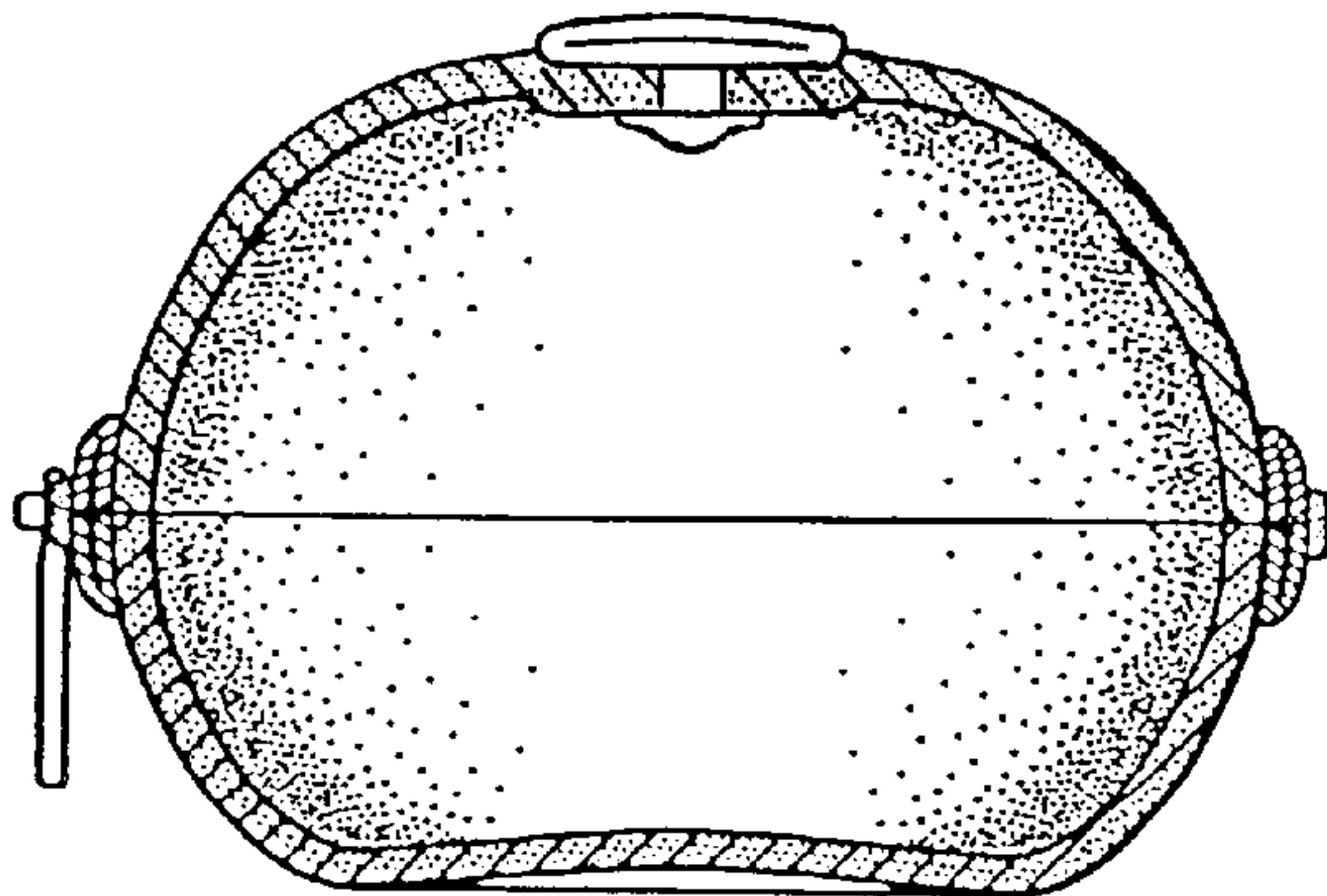
***Fig. 18***



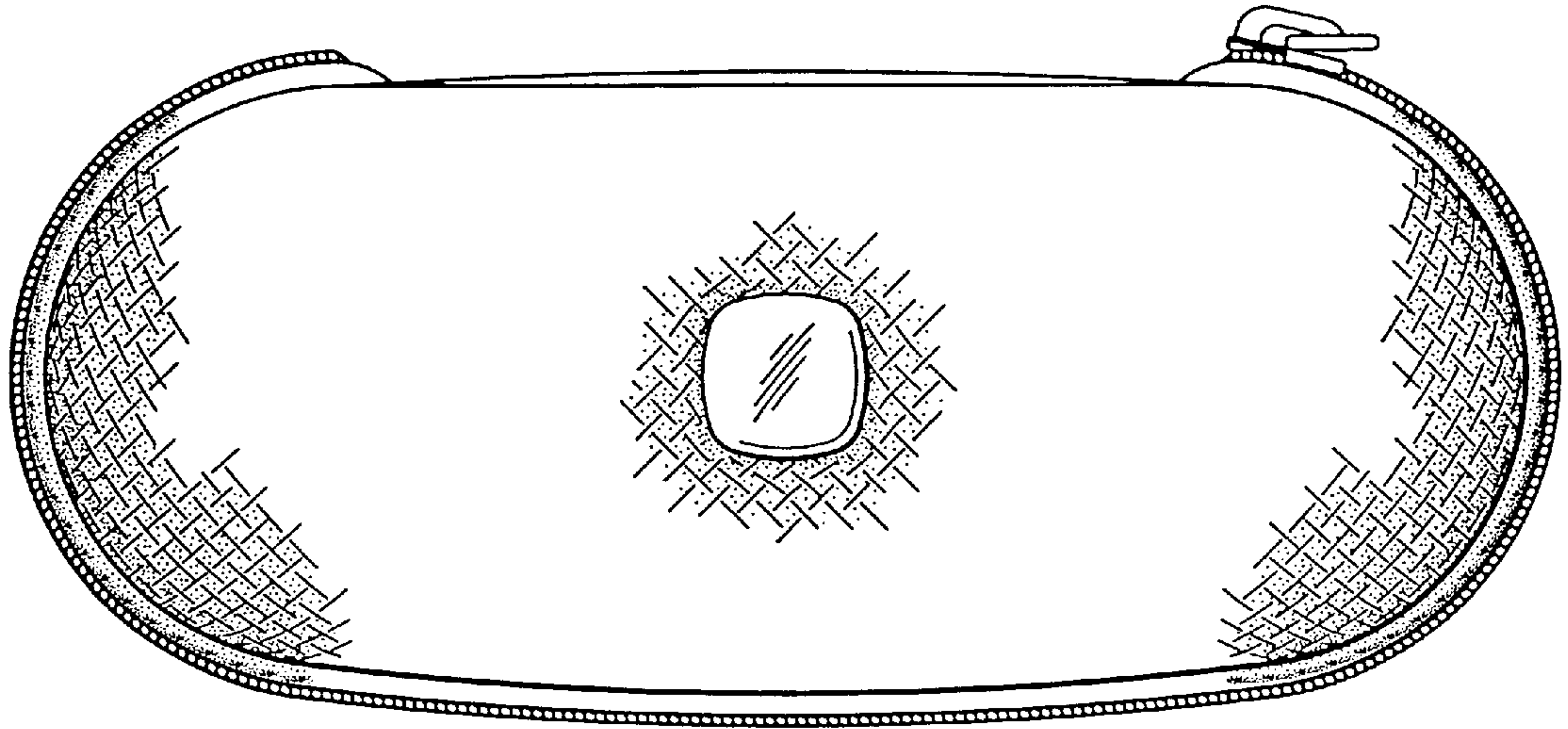
***Fig. 19***



***Fig. 20***



***Fig. 21***



***Fig. 22***

