



US00D451665B1

(12) **United States Design Patent**
Phillips et al.

(10) **Patent No.:** **US D451,665 S**

(45) **Date of Patent:** **** Dec. 11, 2001**

(54) **WINE BOTTLE TOTE**

(76) Inventors: **John Allan Phillips**, 5210 Village Pkwy., Rogers, AR (US) 72758;
Richard Owens, P.O. Box 170, Edgecliff, New South Wales (AU), 2027

(**) Term: **14 Years**

(21) Appl. No.: **29/120,826**

(22) Filed: **Mar. 27, 2000**

(51) **LOC (7) Cl.** **03-01**

(52) **U.S. Cl.** **D3/202; D3/285**

(58) **Field of Search** D3/201, 202, 254, D3/273, 276, 283, 289, 285, 301, 303, 315-318; 190/903; 206/446, 457, 527, 822; 224/101, 148.1-148.7, 191.5

(56) **References Cited**

U.S. PATENT DOCUMENTS

- D. 142,258 * 8/1945 Botsford et al. D3/289
- D. 259,677 * 6/1981 Rosenow D3/289

* cited by examiner

Primary Examiner—Stella Reid
Assistant Examiner—Robert A. Delehanty

(74) *Attorney, Agent, or Firm*—Head, Johnson & Kachigian; Trent C. Keisling

(57) **CLAIM**

The design for a wine bottle tote, as shown and described.

DESCRIPTION

FIG. 1 is a front perspective view of a wine bottle tote showing our new design;
 FIG. 2 is a rear perspective view thereof;
 FIG. 3 is an enlarged perspective view of a wine bottle tote shown in an open position, the broken lines showing of wine bottles and a cork screw are for illustrative purposes only and form no part of the claimed design thereof;
 FIG. 4 is a left side elevational view thereof;
 FIG. 5 is a right side elevational view thereof;
 FIG. 6 is a rear view thereof;
 FIG. 7 is a front view thereof;
 FIG. 8 is a top elevational view thereof; and,
 FIG. 9 is a bottom elevational view thereof.

The straps have been shown broken away in FIGS. 6-9 in the drawing for ease of illustration.

The broken lines shown on the wine bottle tote in the drawing are understood to represent stitching.

1 Claim, 5 Drawing Sheets

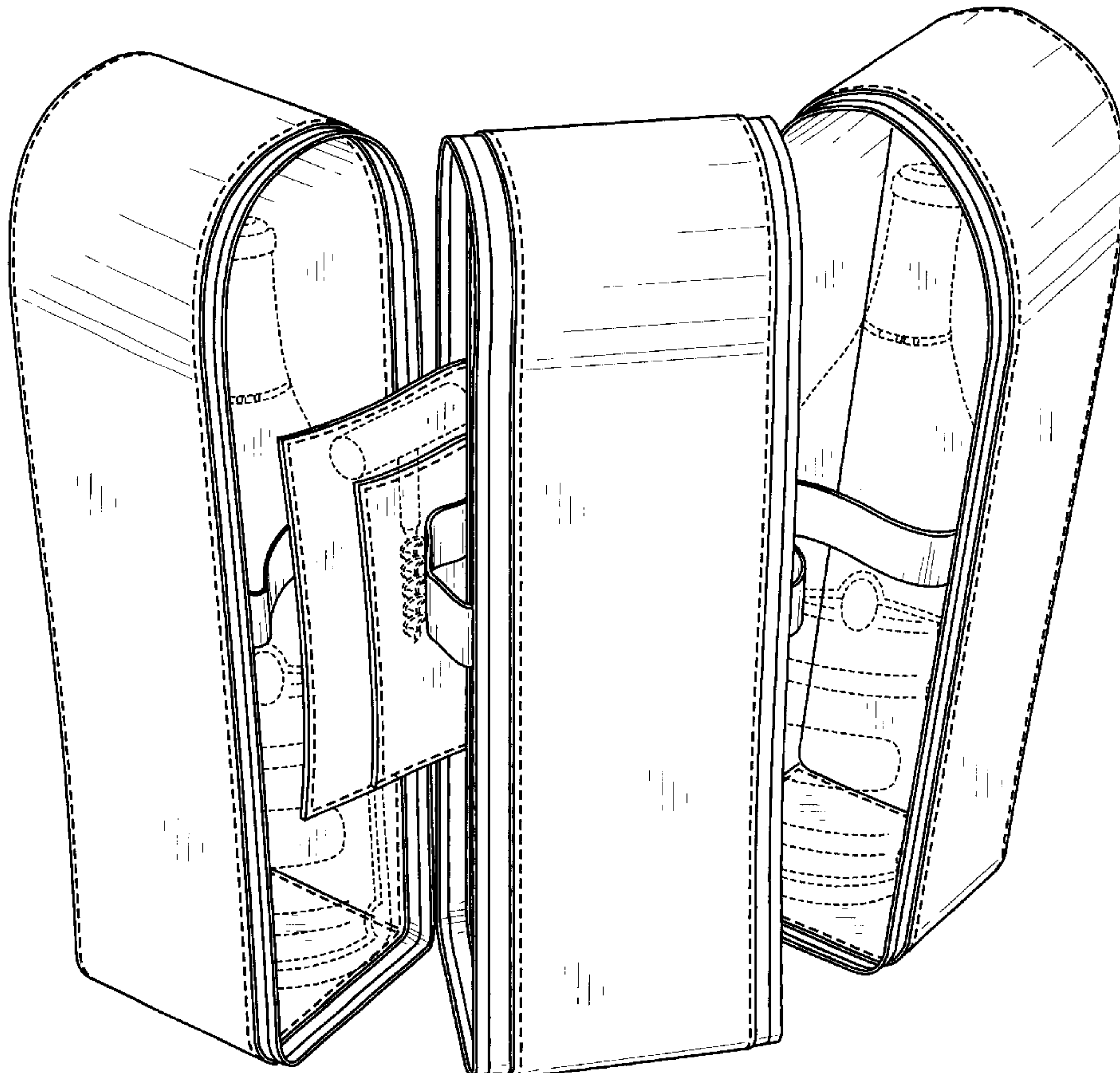

FIG. 1

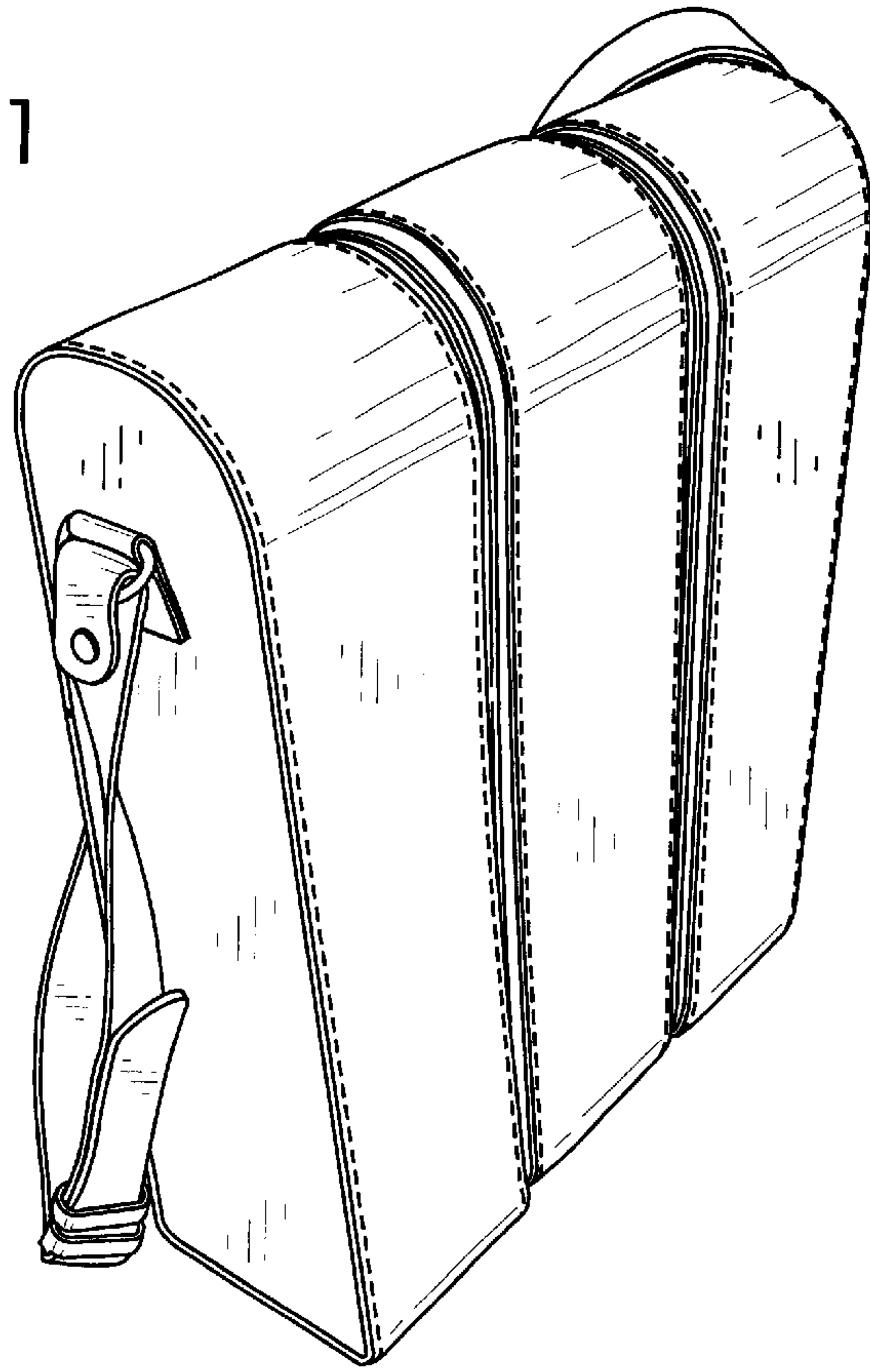

FIG. 2

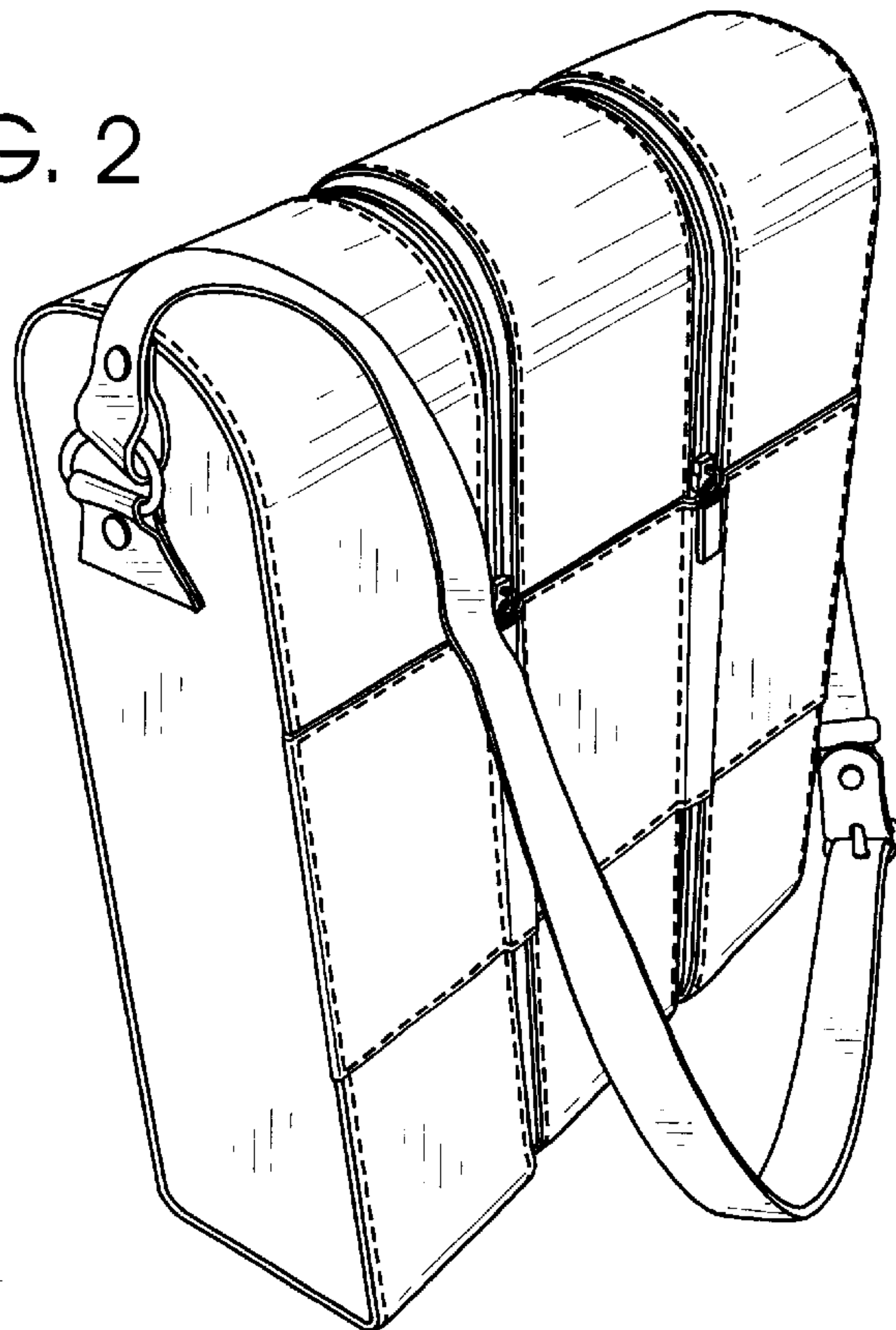
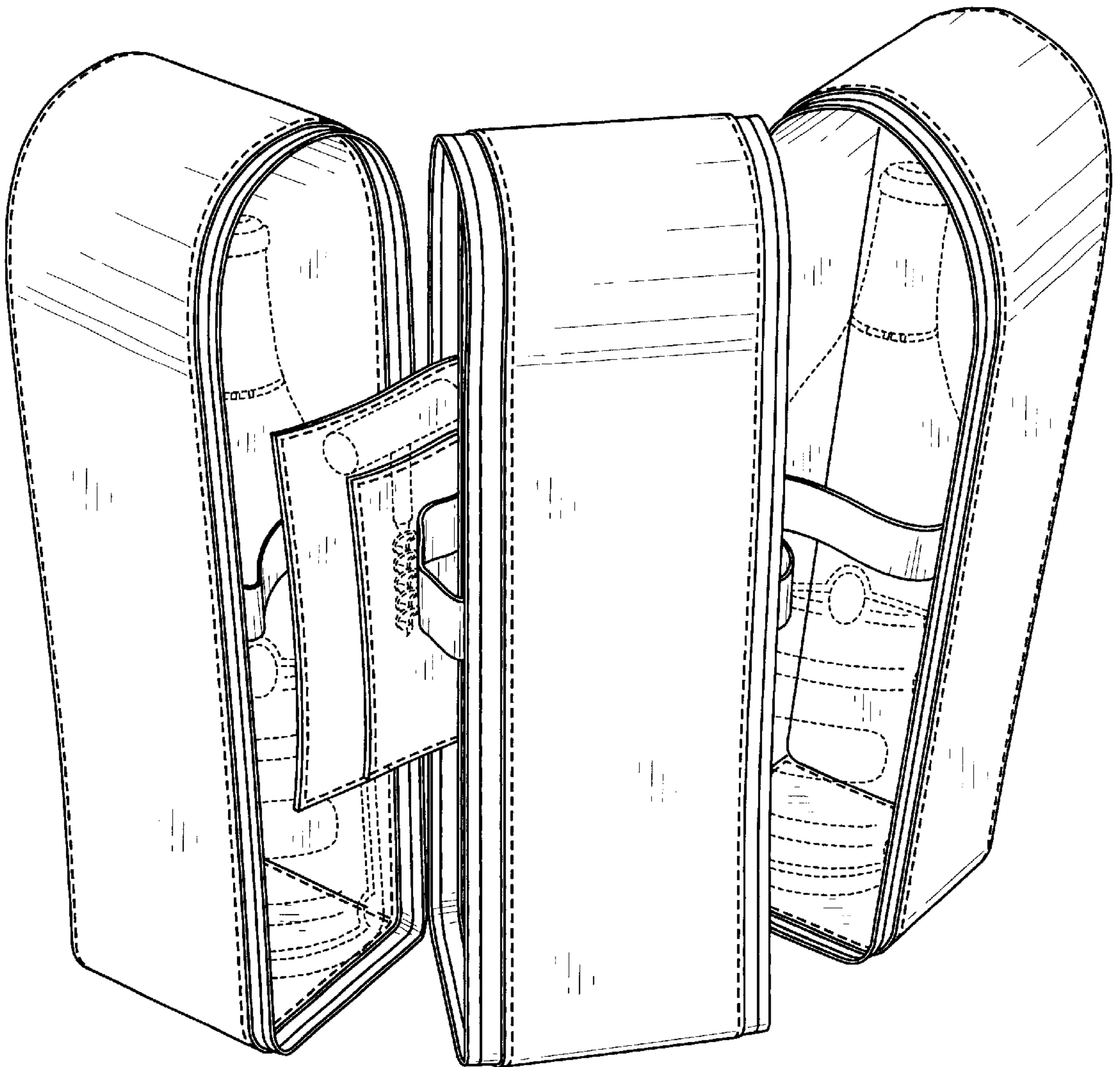

FIG. 3



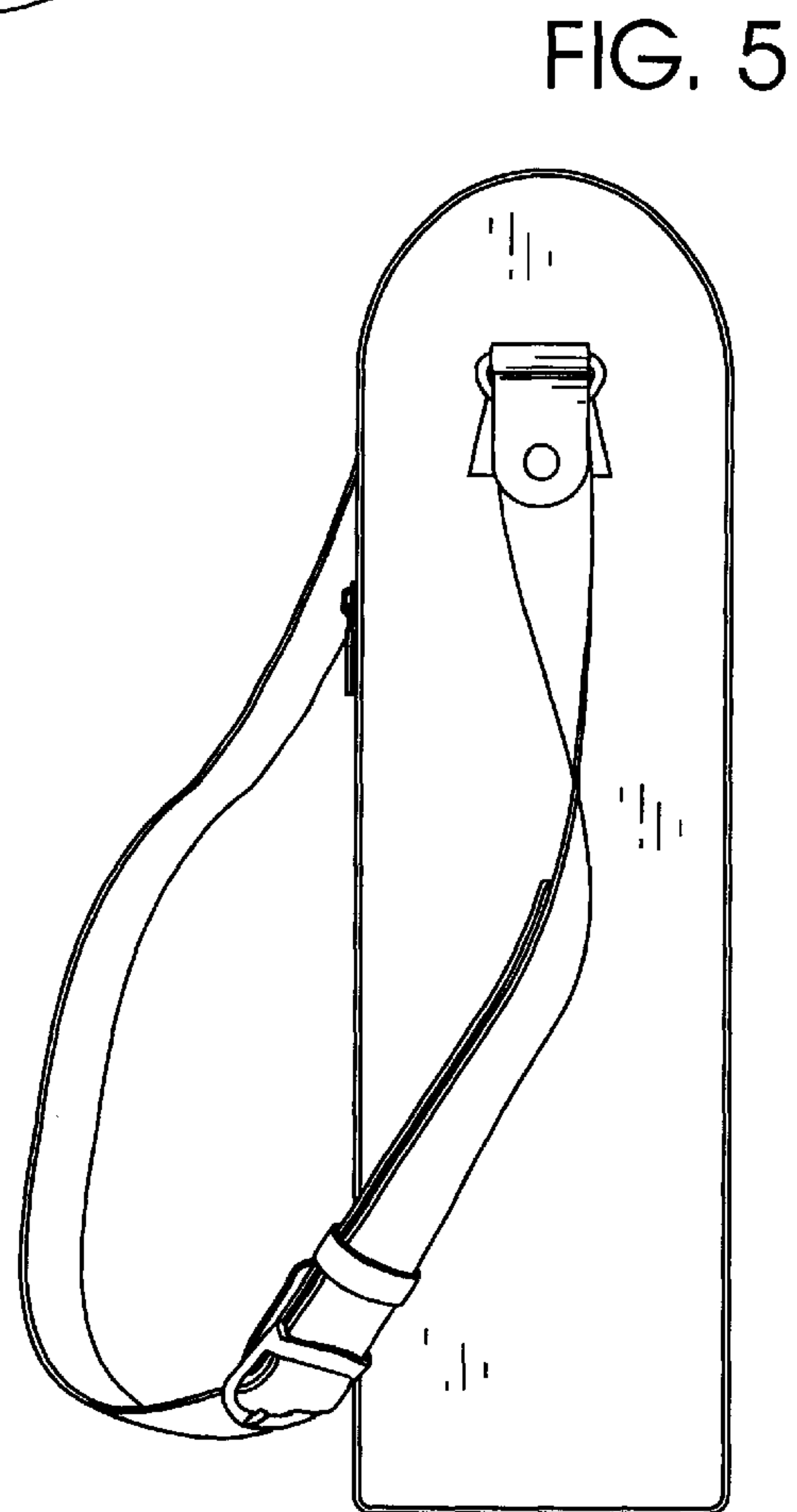
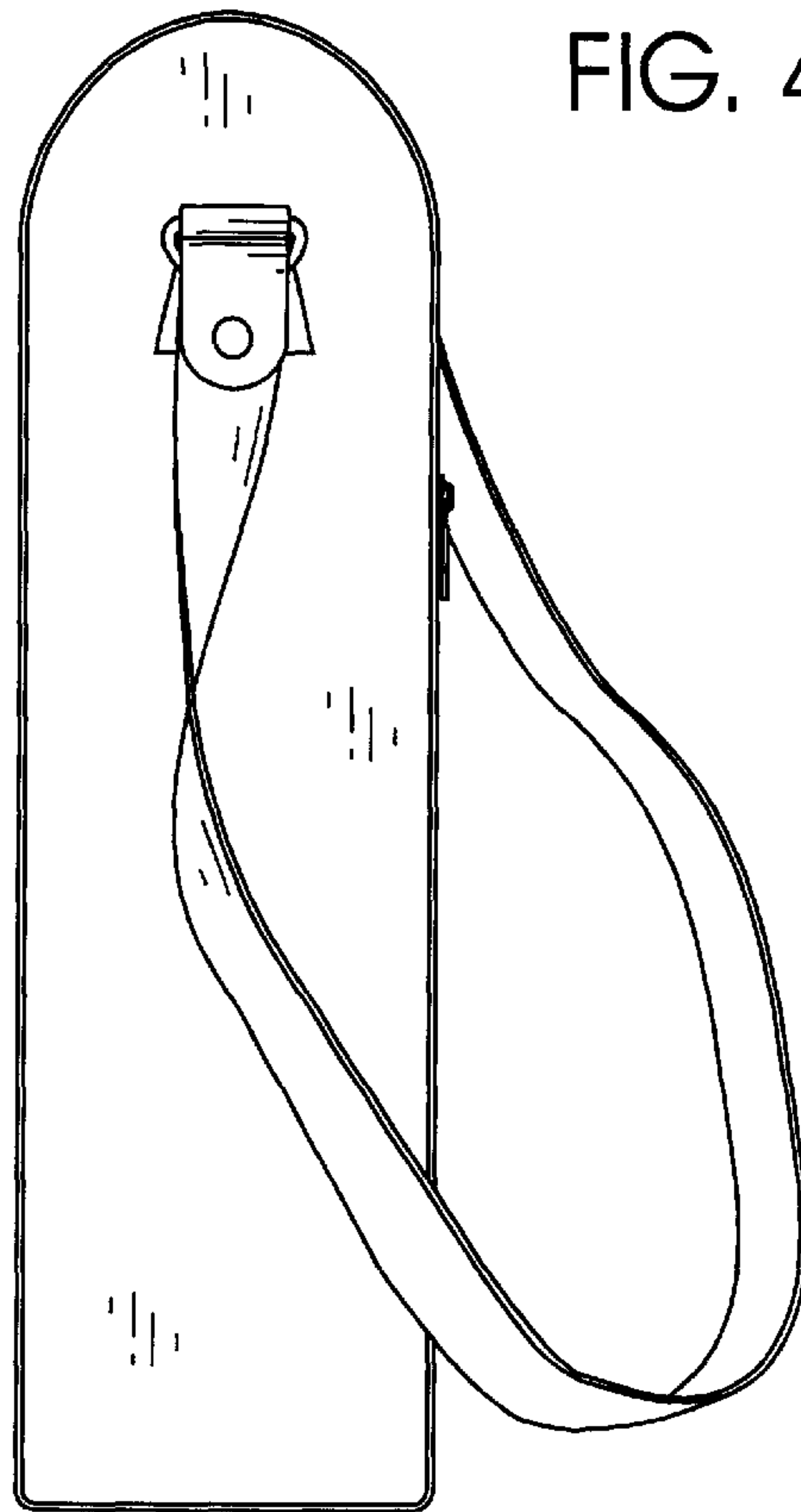

FIG. 6

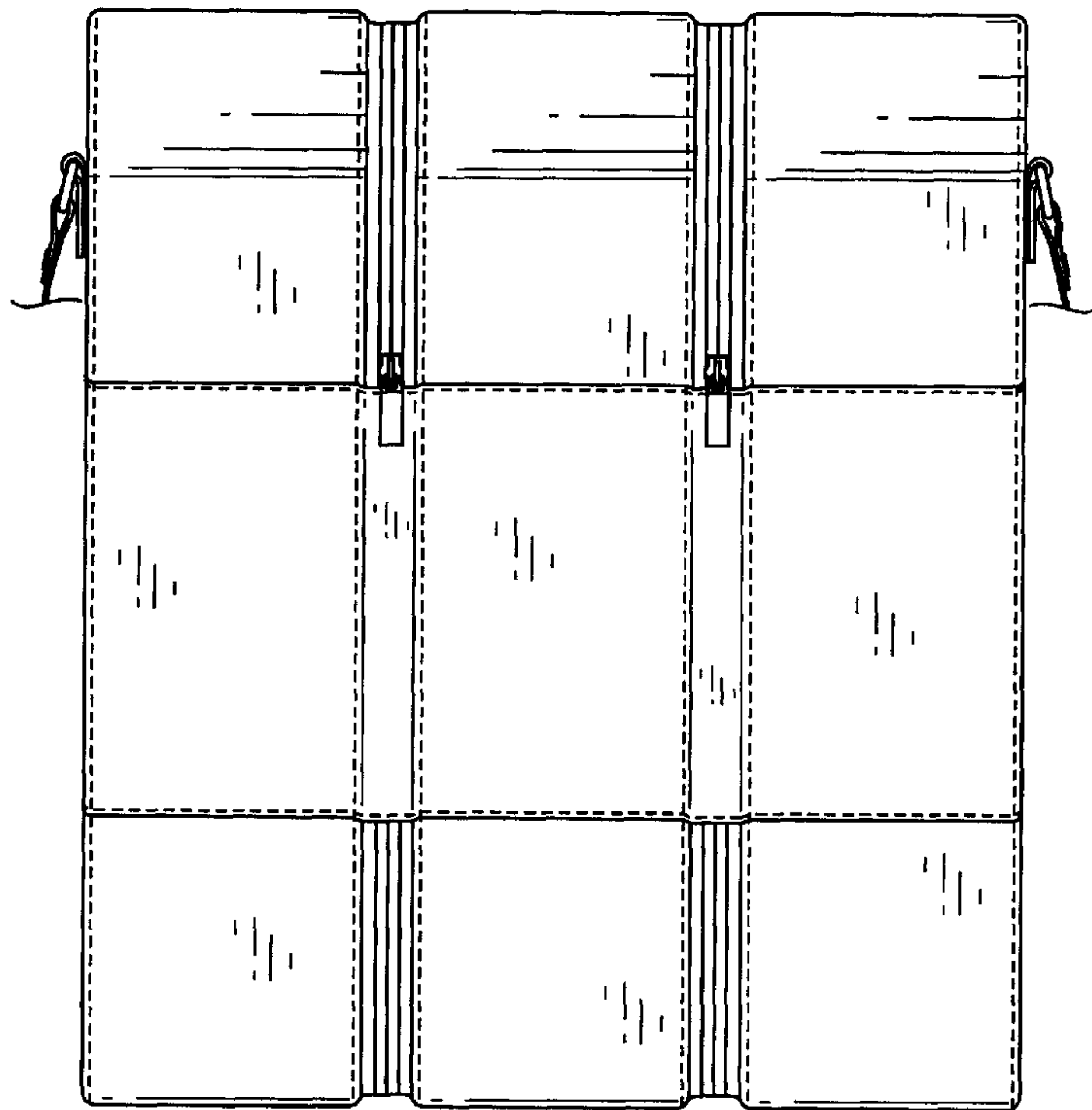

FIG. 7

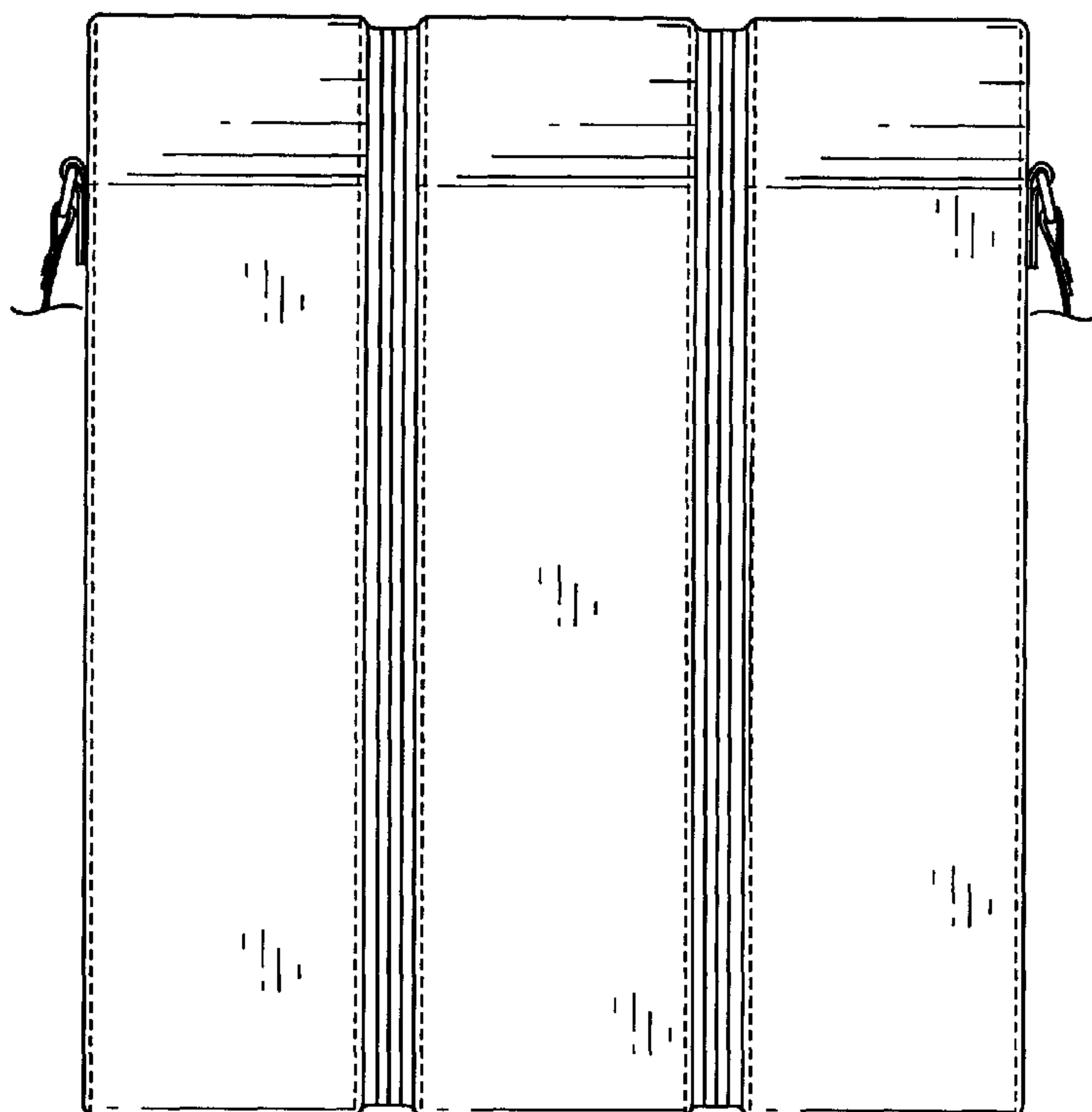

FIG. 8

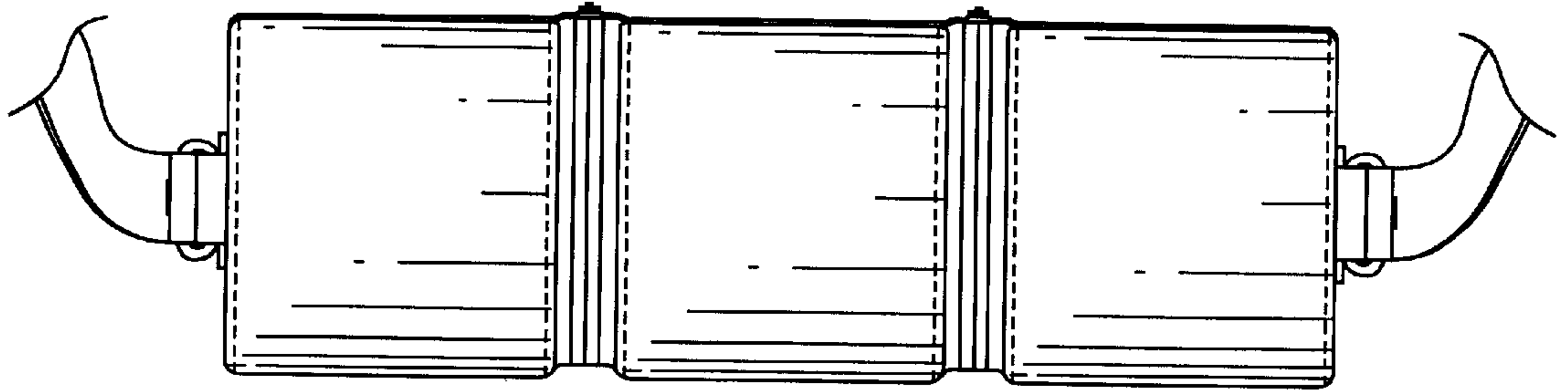

FIG. 9

