



US00D451611B1

(12) **United States Design Patent**
Pontarolo

(10) **Patent No.:** **US D451,611 S**

(45) **Date of Patent:** **** Dec. 4, 2001**

(54) **MODULAR ELEMENTS WITH AERATION FOR FLOORS**

(75) Inventor: **Valerio Pontarolo**, Cordovado (IT)

(73) Assignee: **Pontarolo Engineering Srl**, Cordovado (IT)

(**) Term: **14 Years**

(21) Appl. No.: **29/108,755**

(22) Filed: **Aug. 4, 1999**

(51) **LOC (7) Cl.** **25-99**

(52) **U.S. Cl.** **D25/119; D25/138**

(58) **Field of Search** **D25/138, 199; 249/28-32**

(56) **References Cited**

U.S. PATENT DOCUMENTS

D. 364,933	*	12/1995	Schalle	D25/199
1,434,242	*	10/1922	Allbright	249/32
1,439,281	*	12/1922	Ambursen	249/31 X
3,352,079	*	11/1967	Strong	D25/199 X
4,411,121	*	10/1983	Blacklin et al.	D25/138 X
5,107,654	*	4/1992	Leonardis	D25/199 X

OTHER PUBLICATIONS

“The Dome”, p. 9, The Uni-form System, Edward W. Davis, Boston MA, 1918.*

* cited by examiner

Primary Examiner—Louis S. Zarfaz

Assistant Examiner—Robert A. Delehanty

(74) *Attorney, Agent, or Firm*—Antonelli, Terry, Stout & Kraus, LLP

(57) **CLAIM**

The ornamental design for a modular elements with aeration for floors, as shown.

DESCRIPTION

FIG. 1 is a topside perspective view of a first embodiment of a modular element with aeration for floors;

FIG. 2 is a front side elevation view thereof;

FIG. 3 is a rear side elevation view thereof;

FIG. 4 is a right side elevation view thereof;

FIG. 5 is a left elevation side view thereof;

FIG. 6 is a top plan view thereof;

FIG. 7 is a bottom plan view thereof.

FIG. 8 is a top side perspective view of a second of a modular element with aeration for floors;

FIG. 9 is a front side elevation view thereof;

FIG. 10 is a rear side elevation view thereof;

FIG. 11 is a right side elevation view thereof;

FIG. 12 is a left side elevation view thereof;

FIG. 13 is a top plan view thereof; and,

FIG. 14 is a bottom plan view thereof.

1 Claim, 14 Drawing Sheets

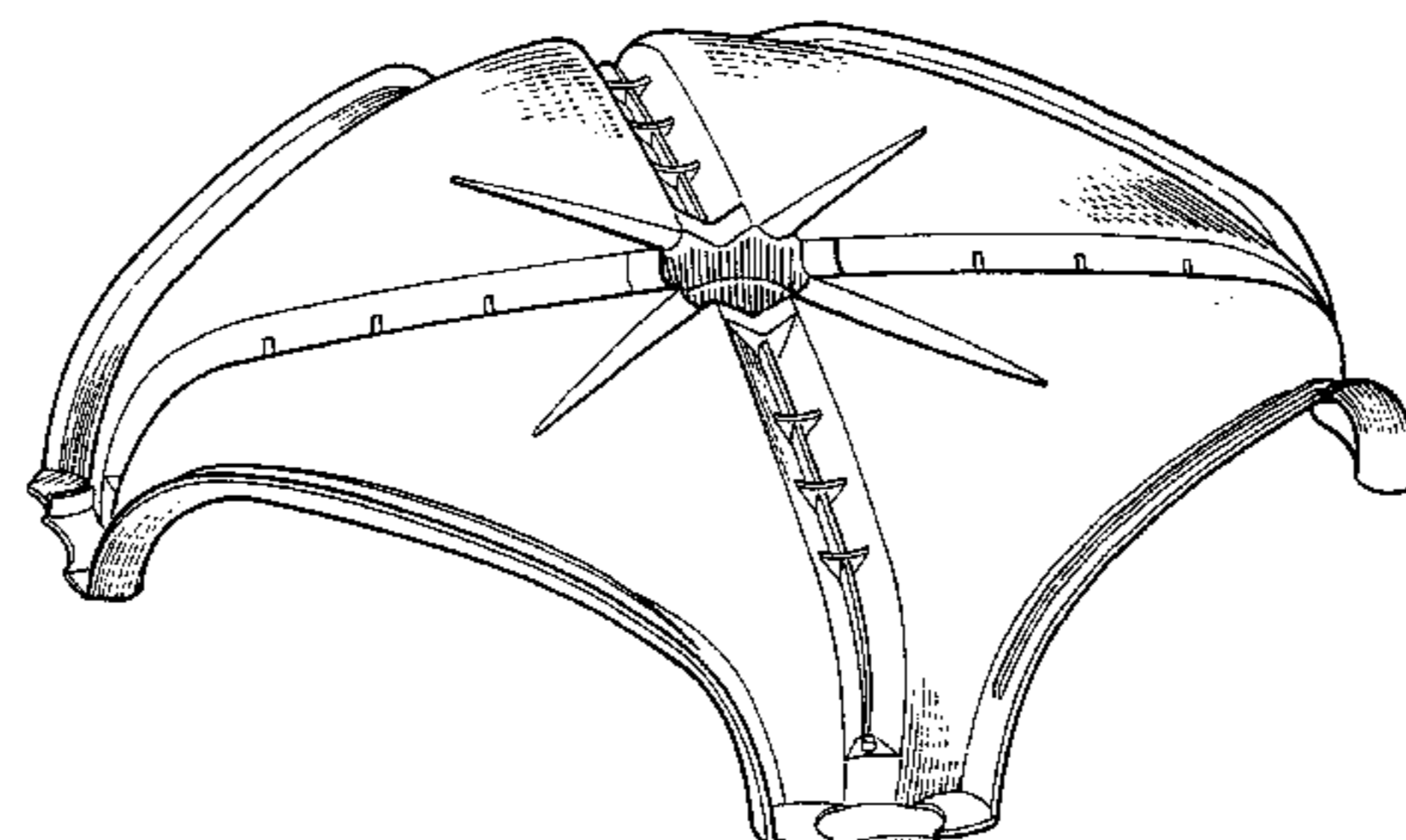
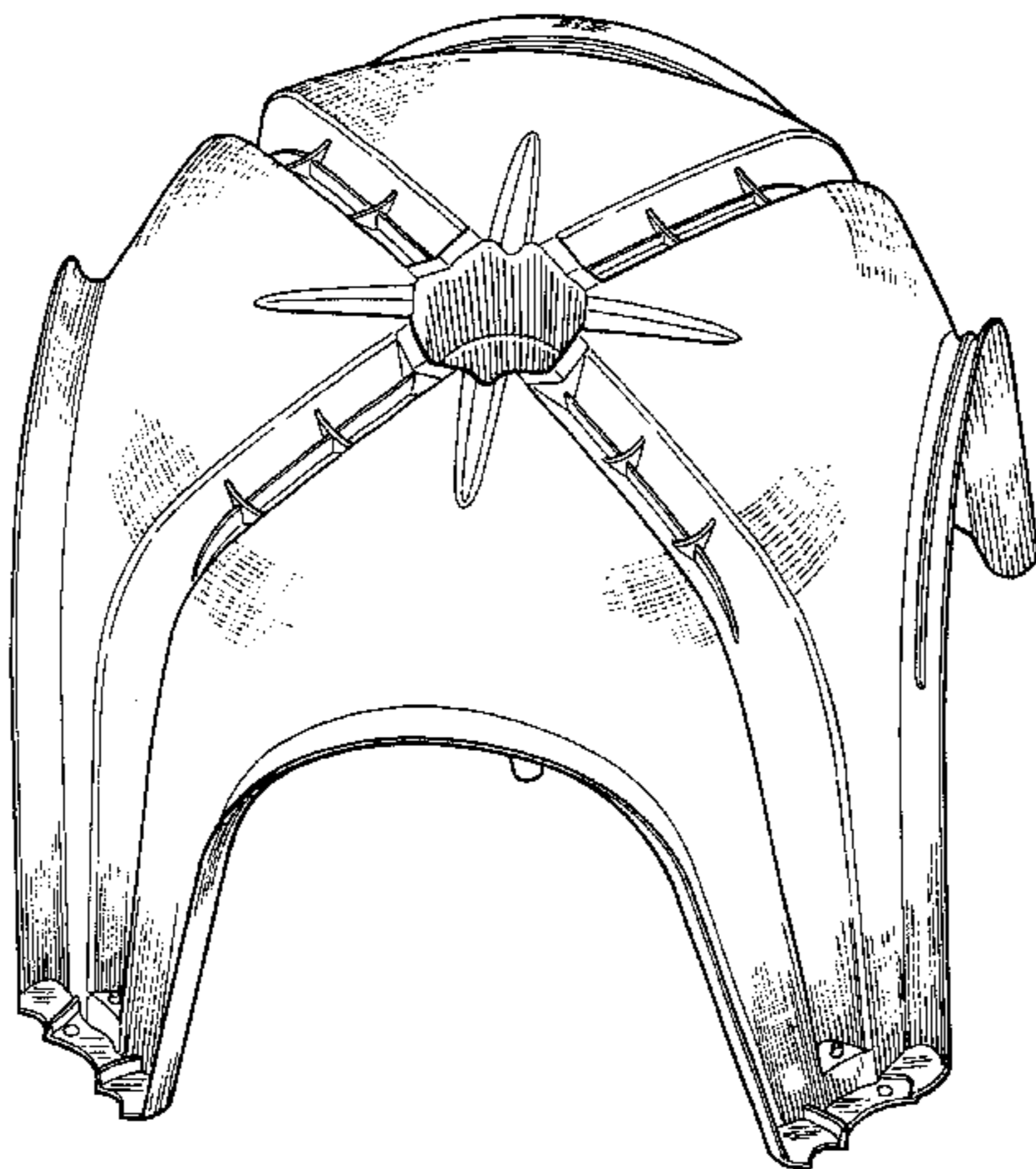

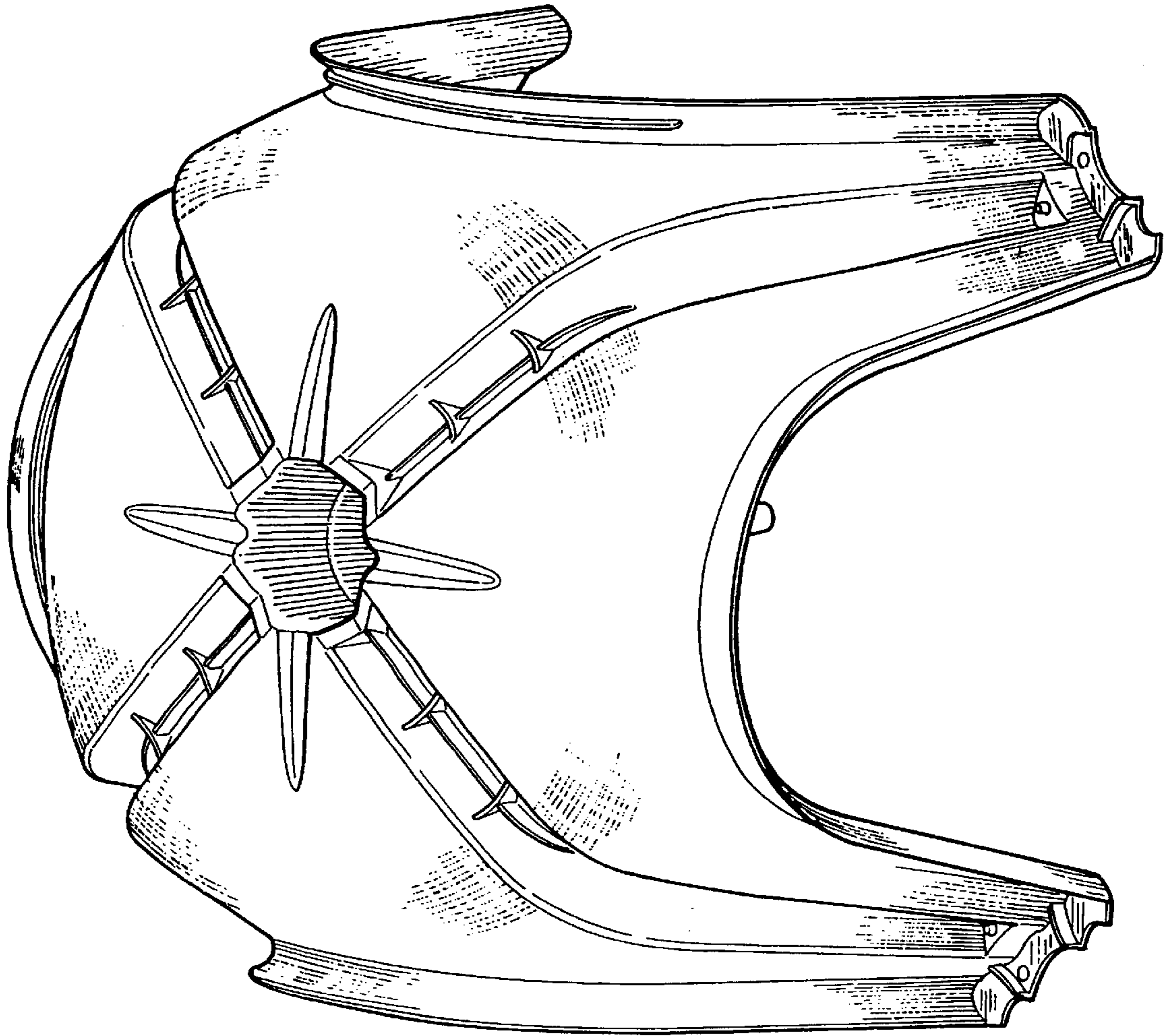

FIG. 1

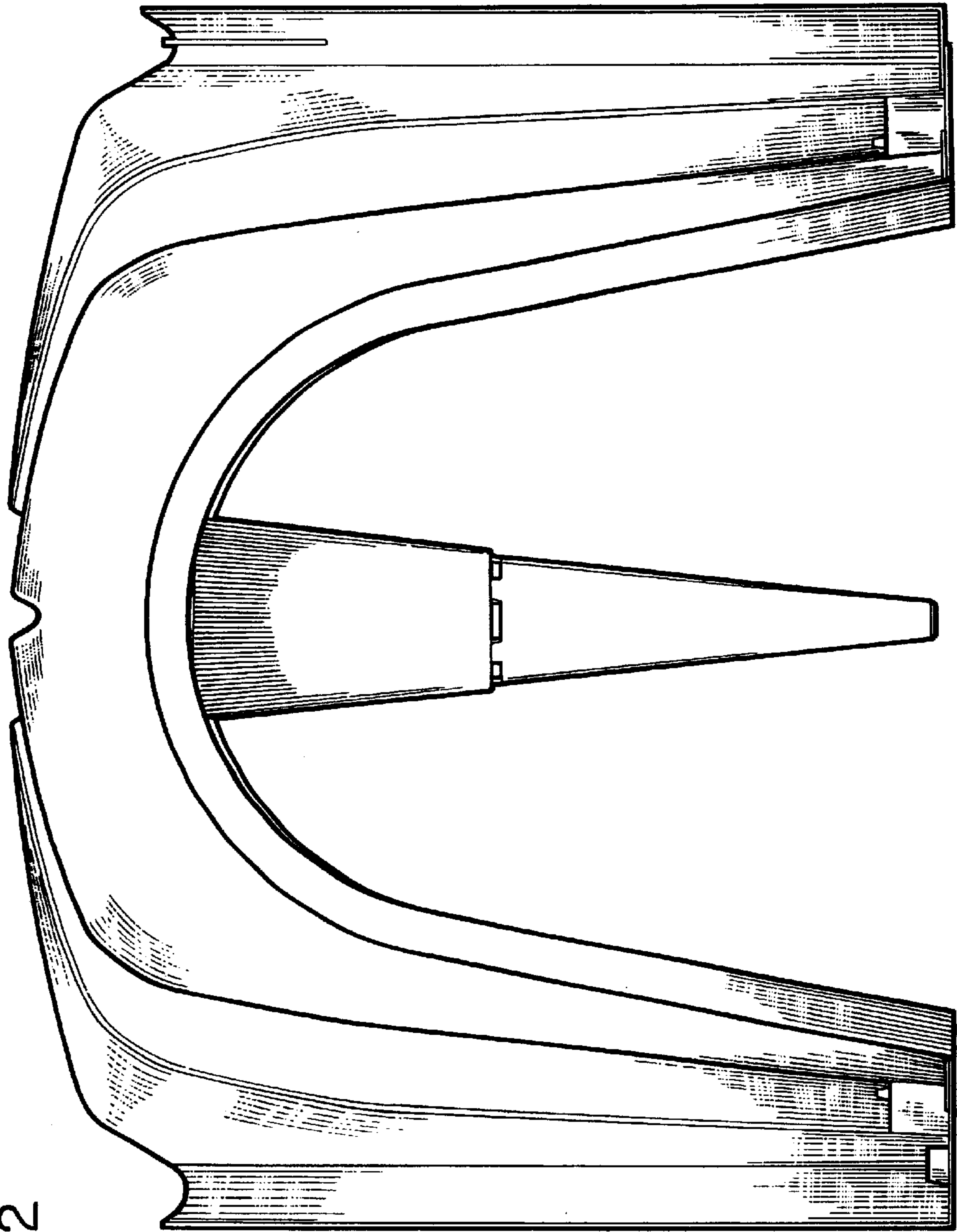

FIG. 2

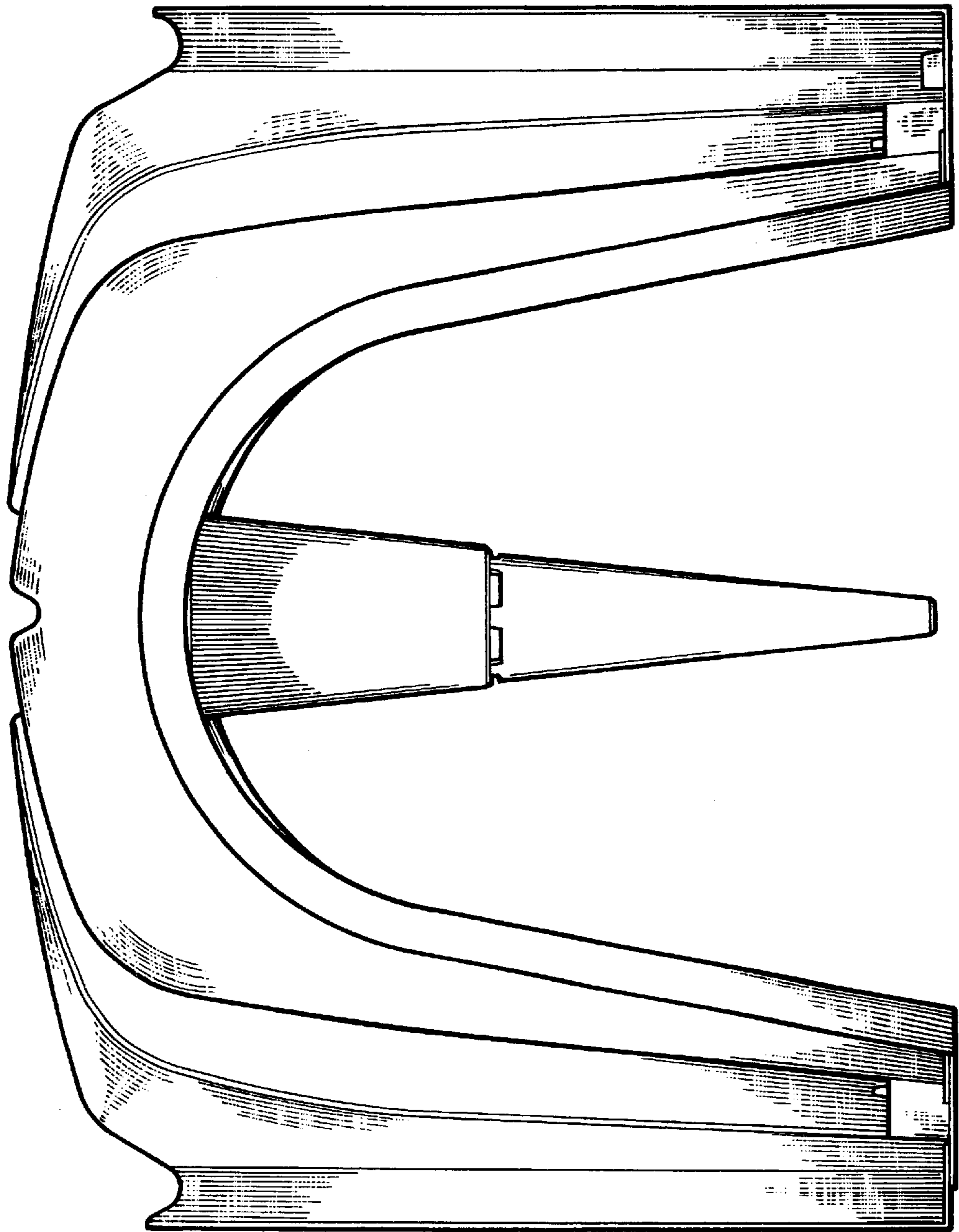

FIG. 3

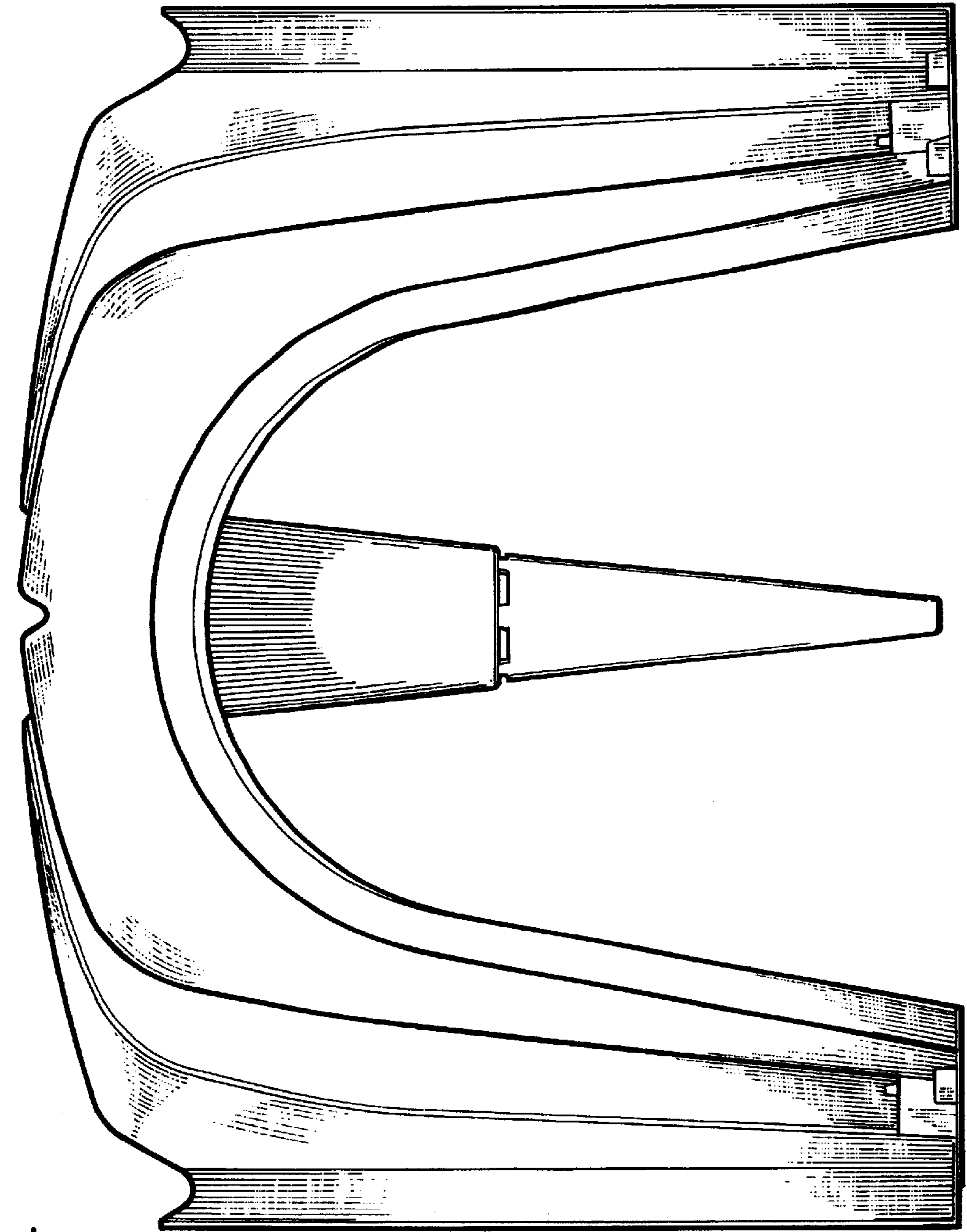

FIG. 4

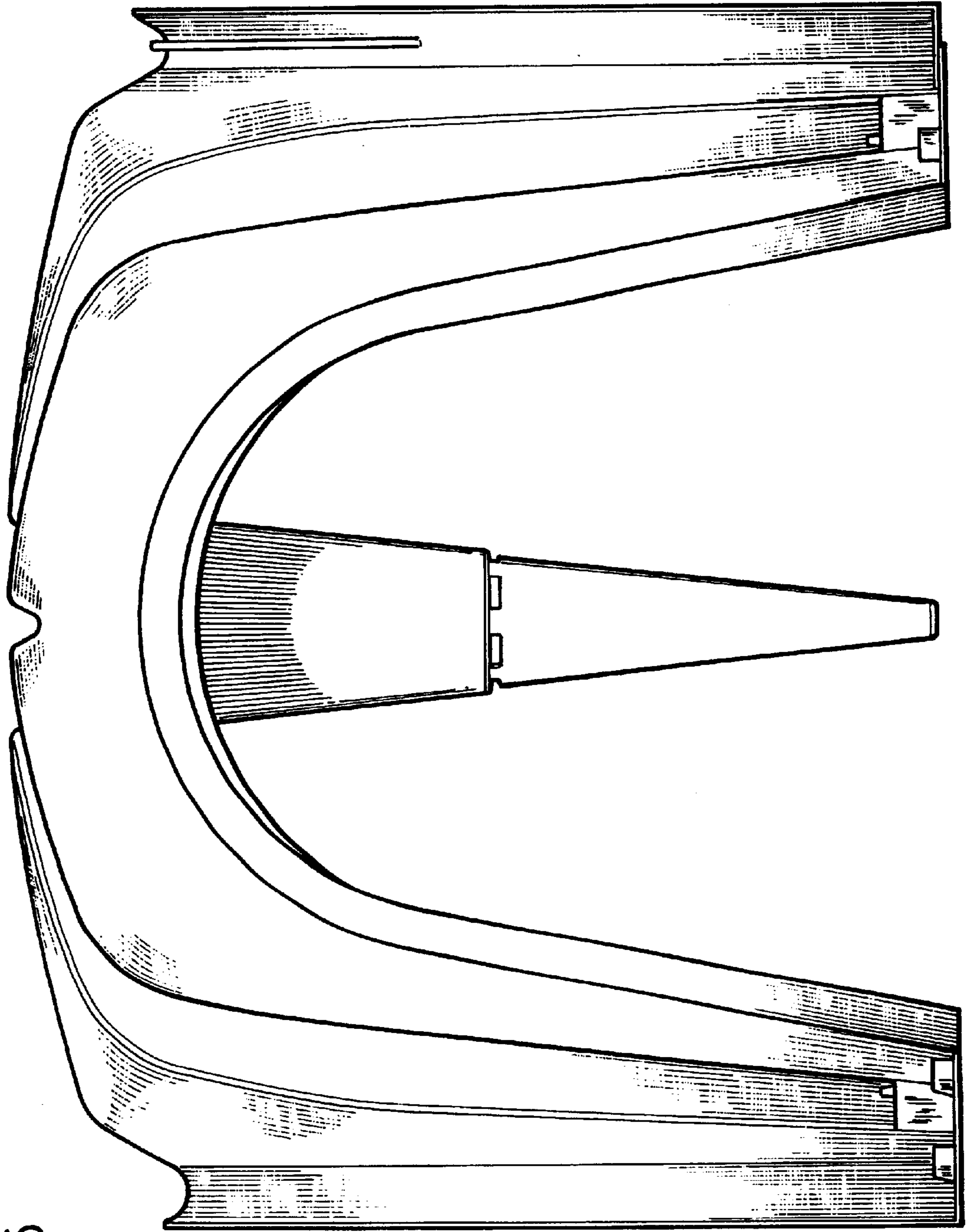

FIG. 5

FIG. 6

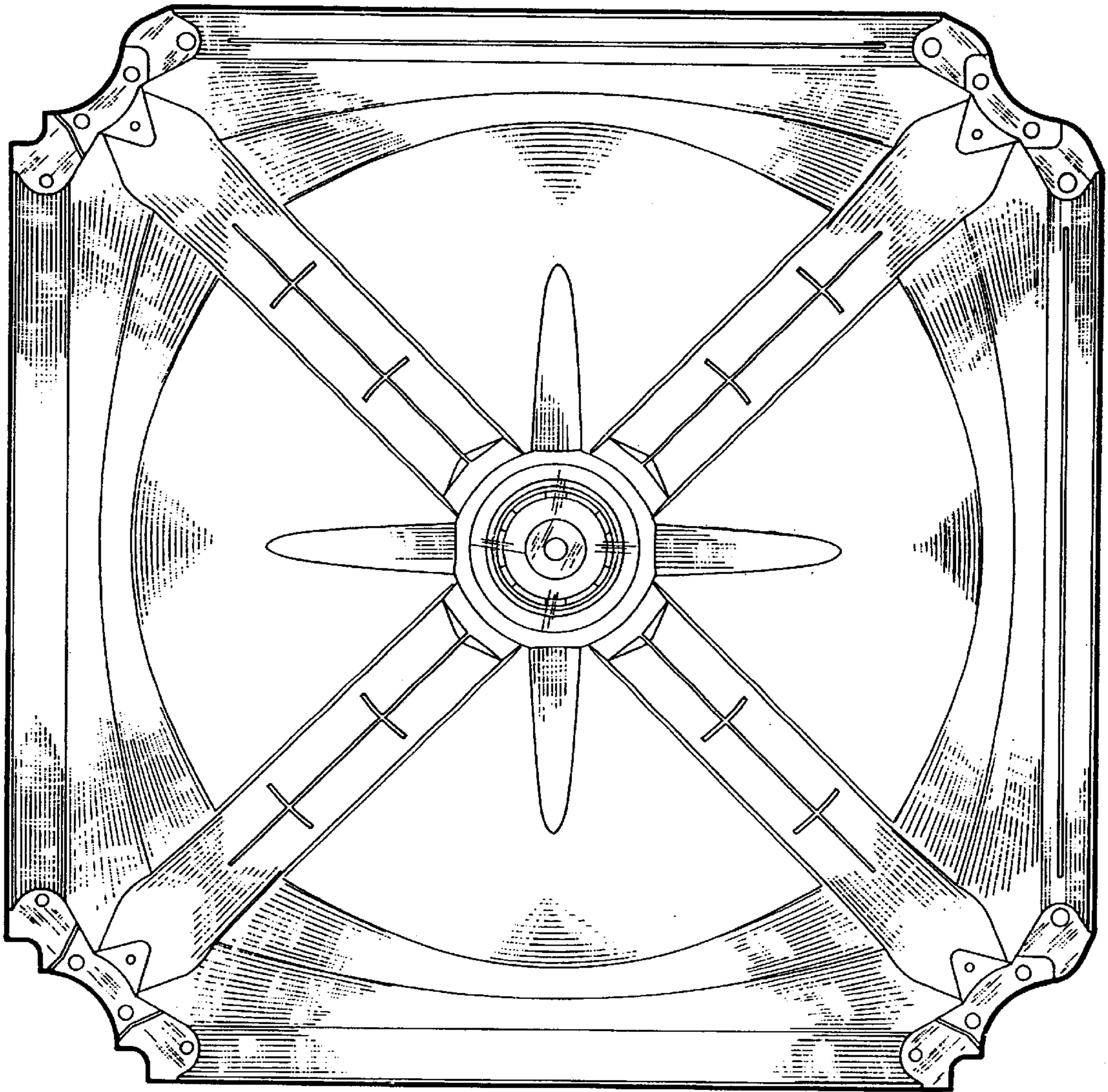
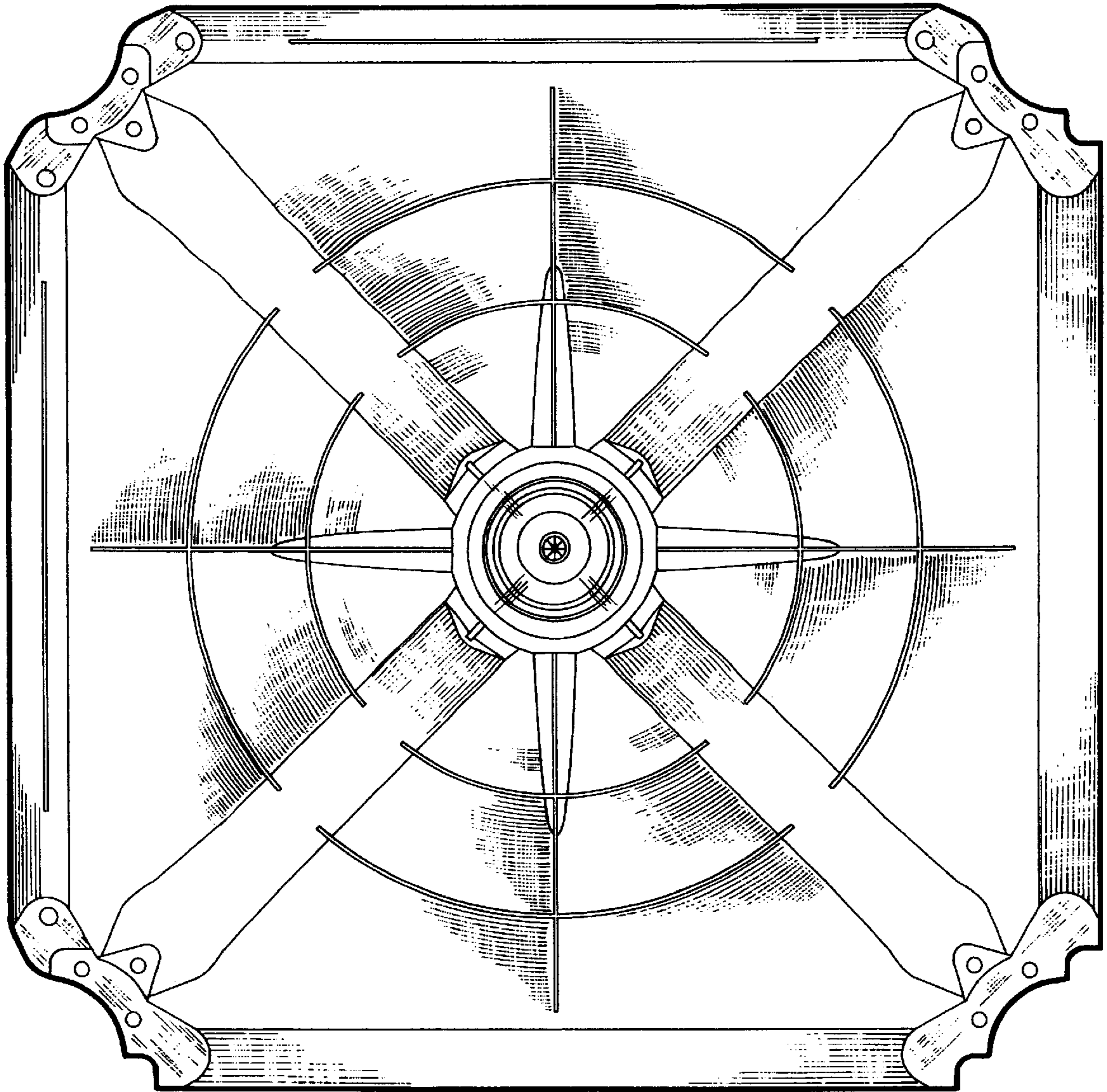

FIG. 7



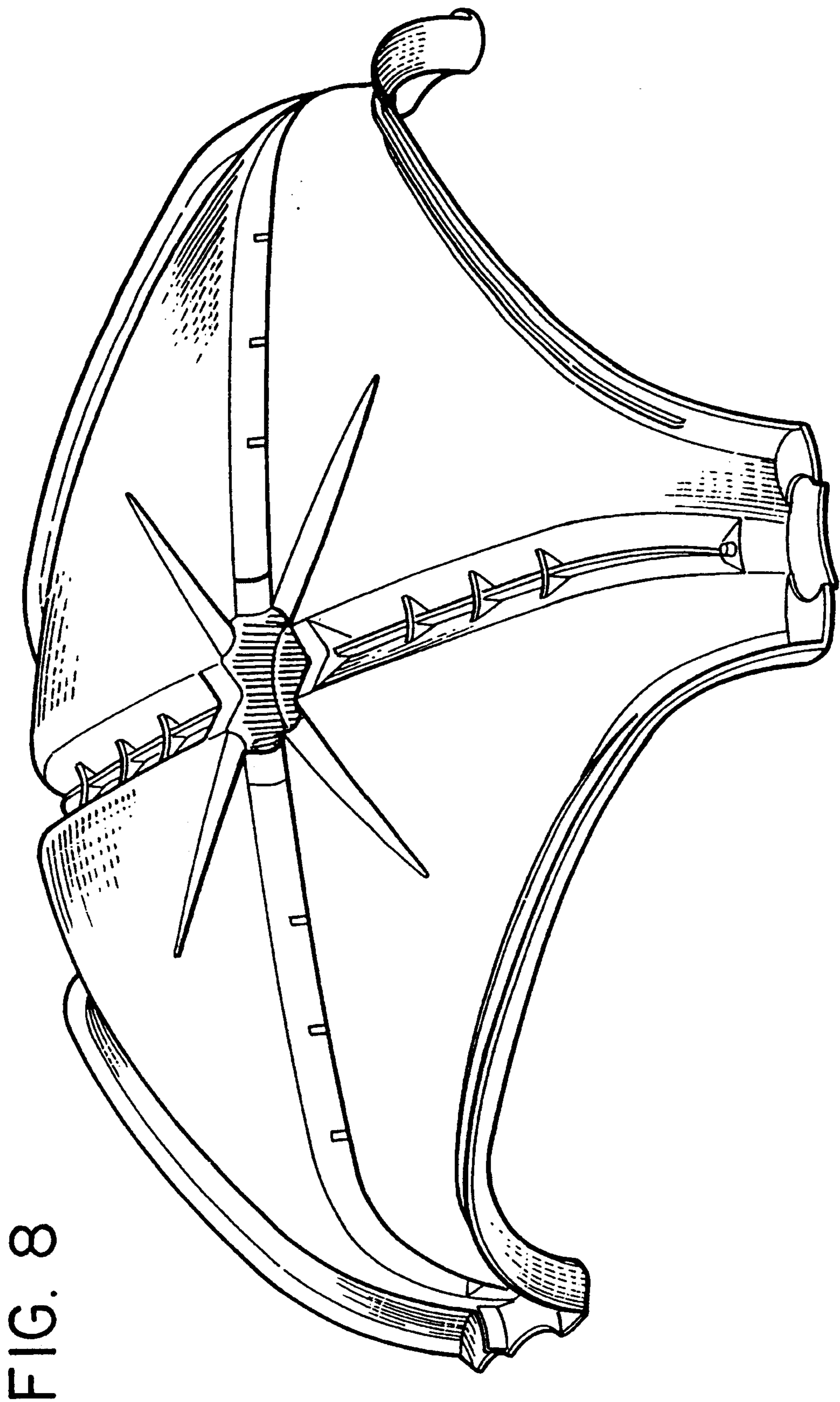

FIG. 8

FIG. 9

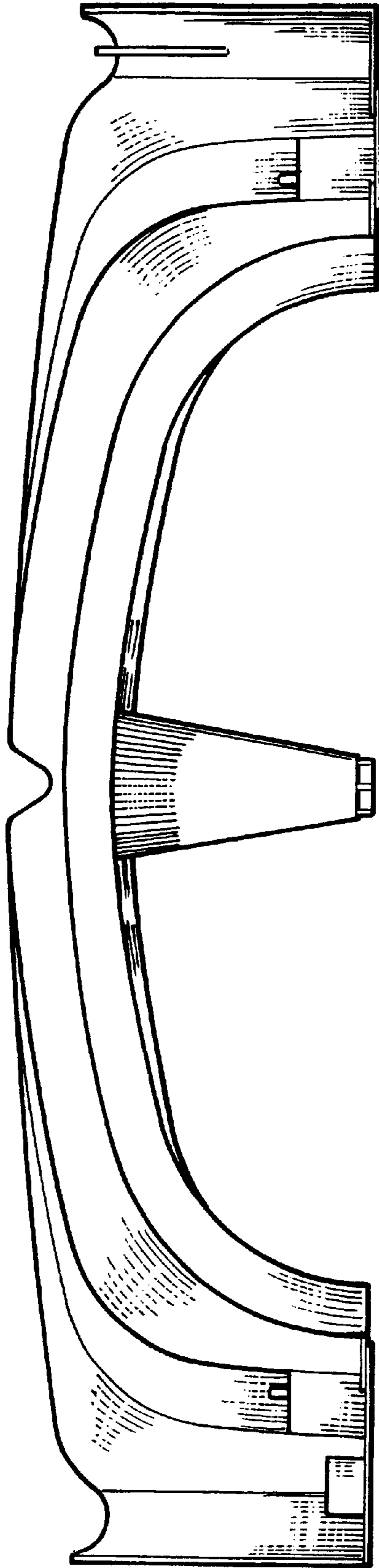

FIG. 10

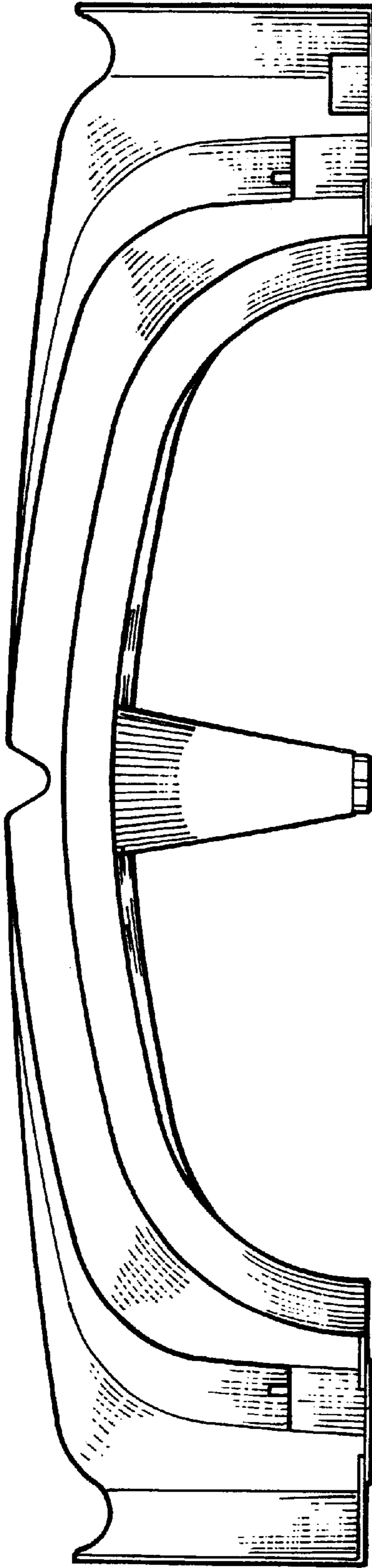

FIG. II

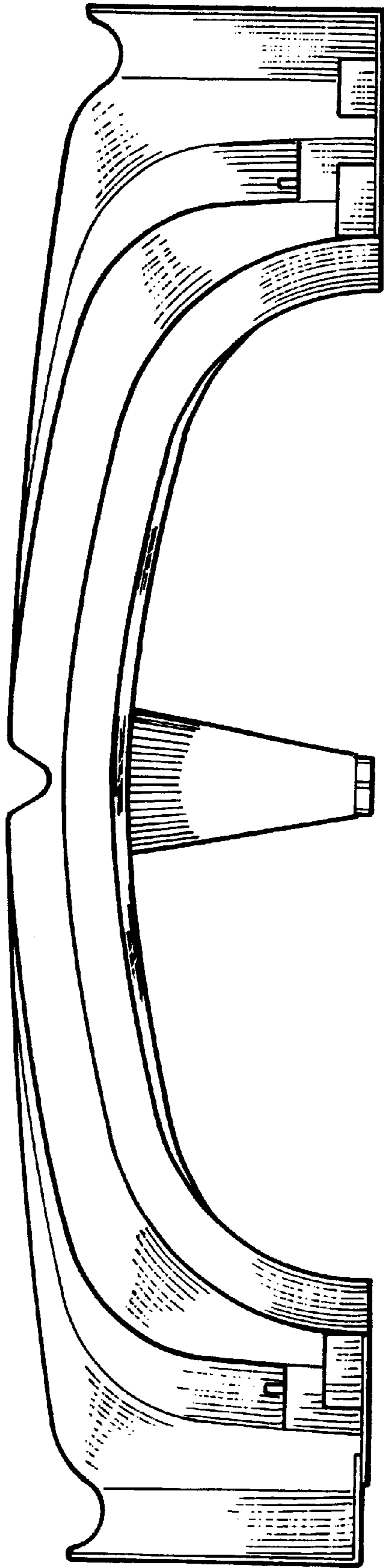

FIG. 12

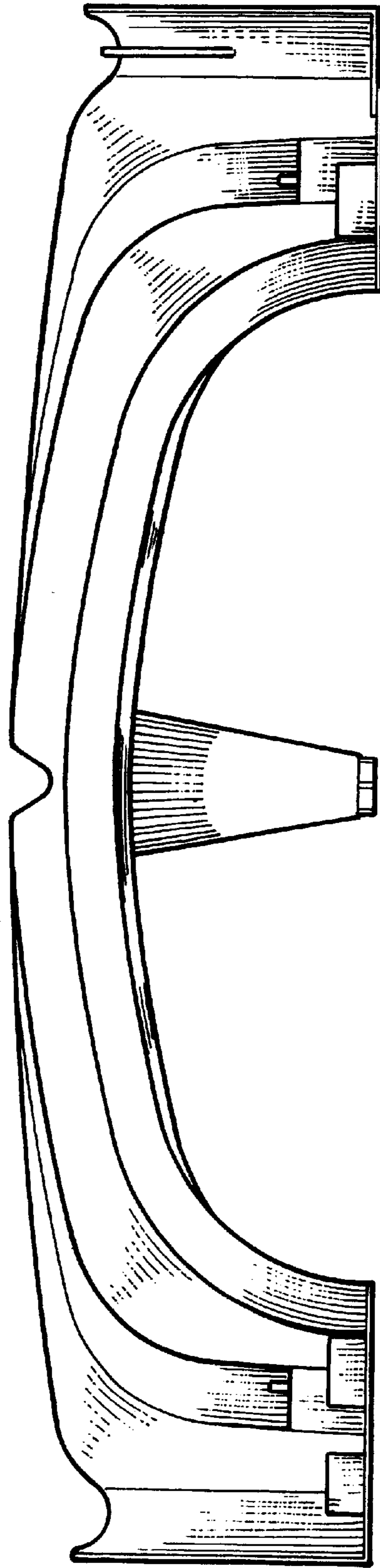

FIG. 13

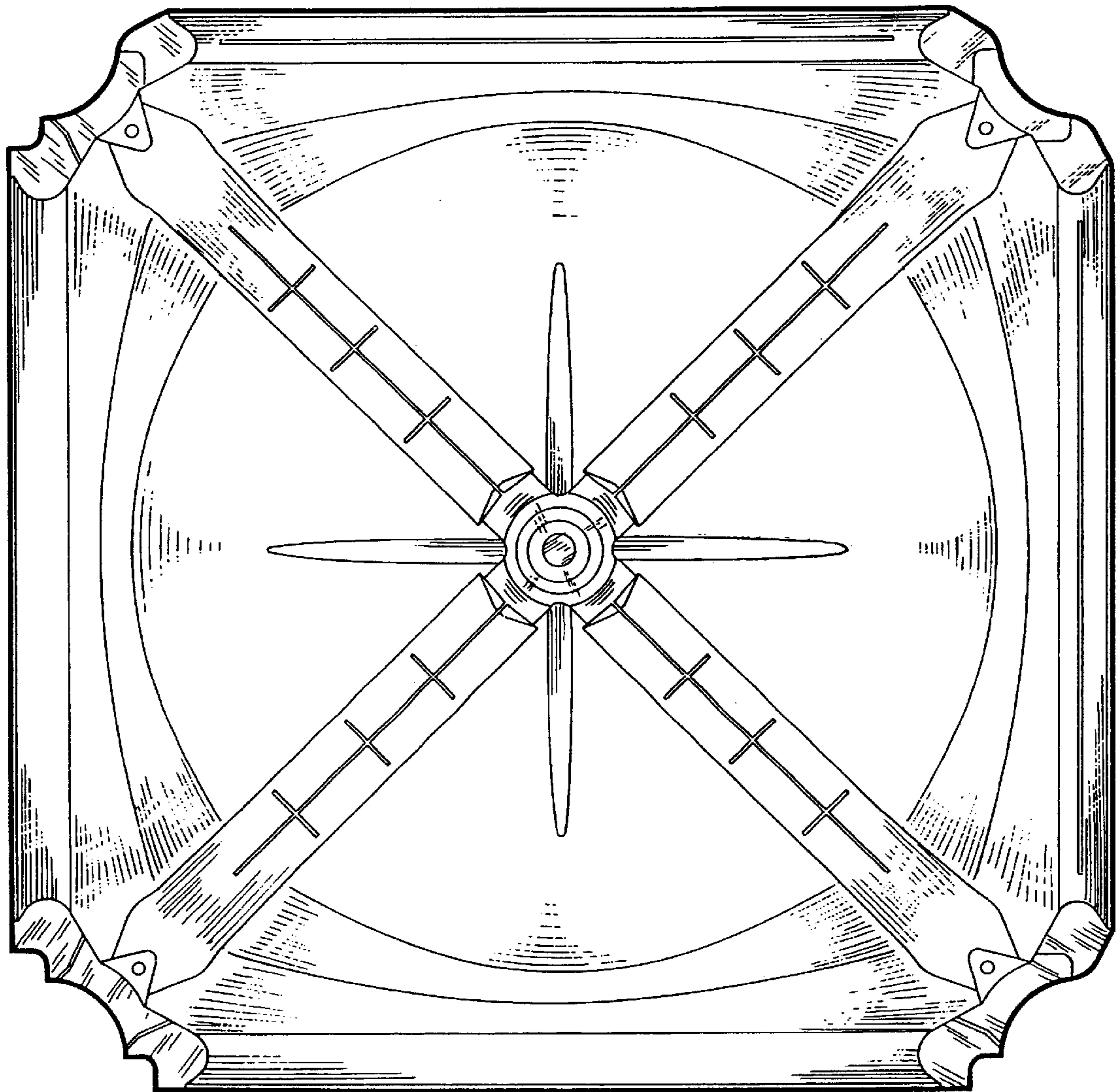
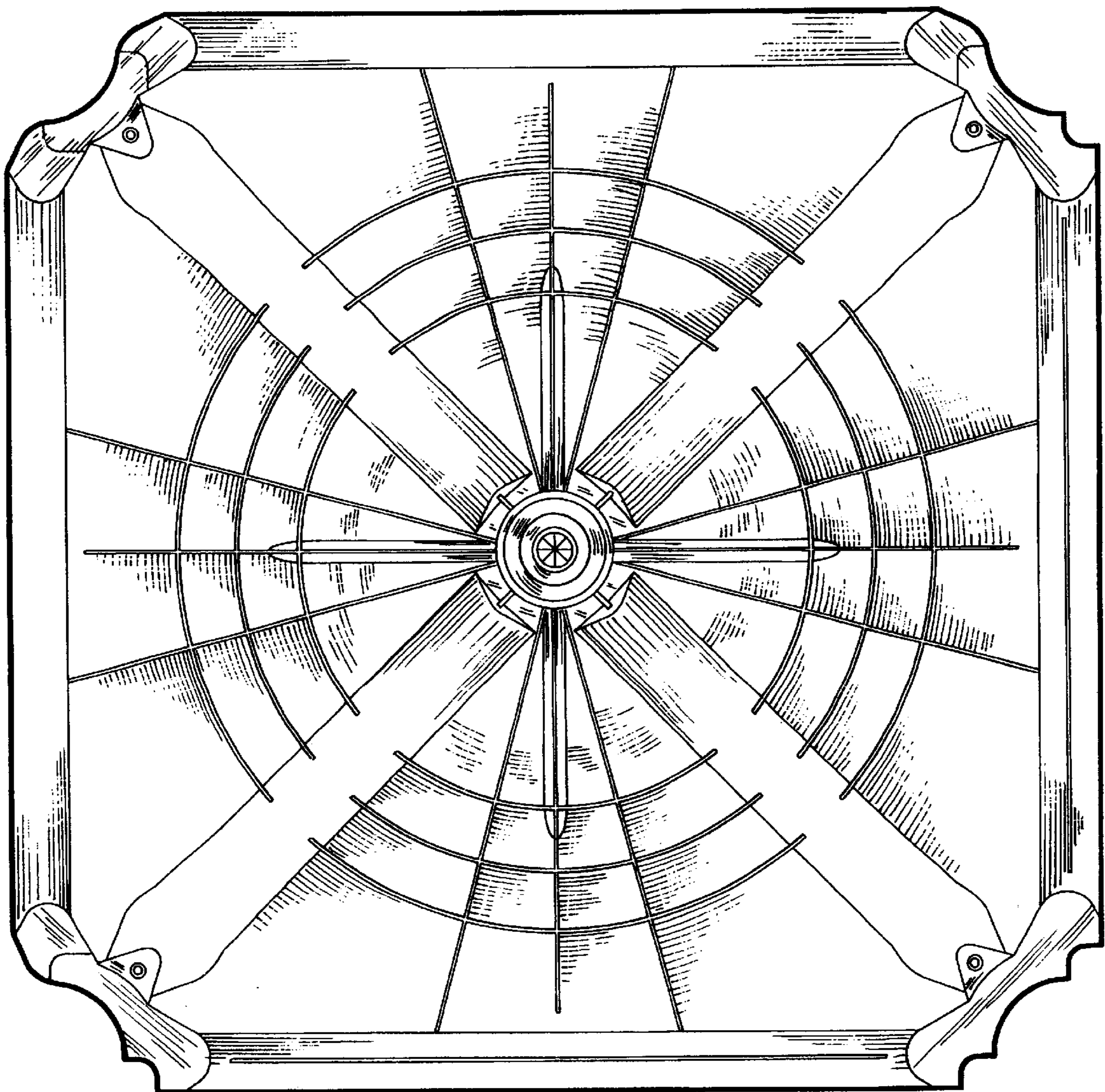

FIG. 14



UNITED STATES PATENT AND TRADEMARK OFFICE
CERTIFICATE OF CORRECTION

PATENT NO. : Des 451,611 S
DATED : December 4, 2001
INVENTOR(S) : Valerio Pontarolo

Page 1 of 9

It is certified that error appears in the above-identified patent and that said Letters Patent is hereby corrected as shown below:

Title page.

The title page, showing the illustrative figure, should be deleted and substitute therefore the attached title page.

Drawings.

The drawing sheets, consisting of Figs. 8-14. should be deleted to be replaced with the drawing sheets, consisting of Figs. 8-14, as shown on the attached page.

Signed and Sealed this

Twenty-eighth Day of May, 2002

Attest:

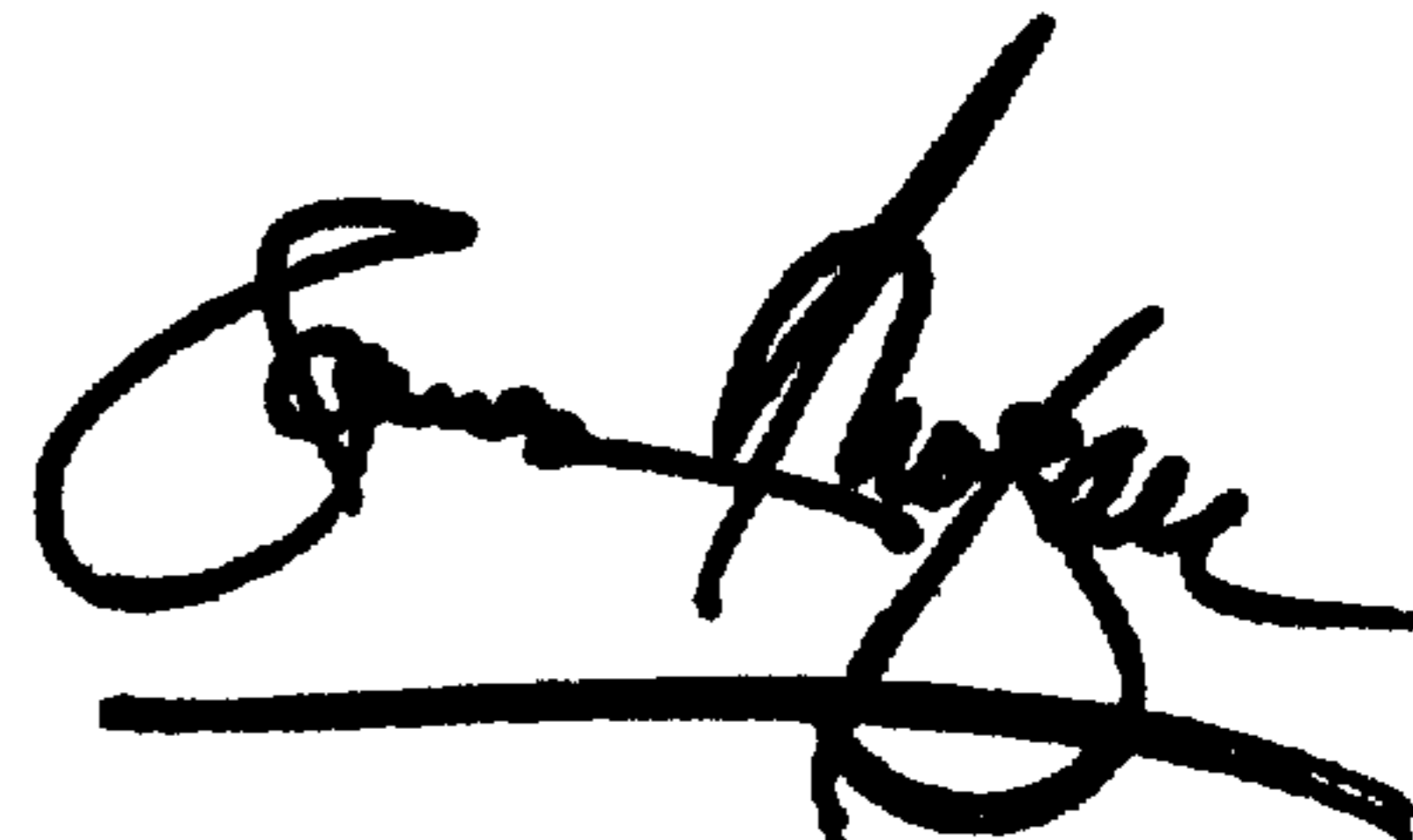

Attesting Officer

JAMES E. ROGAN
Director of the United States Patent and Trademark Office

(12) **United States Design Patent** (10) **Patent No.:** **US D451,611 S**
Pontarolo (45) **Date of Patent:** **** Dec. 4, 2001**

(54) **MODULAR ELEMENTS WITH AERATION FOR FLOORS**
 (75) Inventor: **Valerio Pontarolo**, Cordovado (IT)
 (73) Assignee: **Pontarolo Engineering Srl**, Cordovado (IT)
 (**) Term: **14 Years**
 (21) Appl. No.: **29/108,755**
 (22) Filed: **Aug. 4, 1999**
 (51) **LOC (7) Cl.** **25-99**
 (52) **U.S. Cl.** **D25/119; D25/138**
 (58) **Field of Search** **D25/138, 199; 249/28-32**

(56) **References Cited**
U.S. PATENT DOCUMENTS
 D. 364,933 * 12/1995 Schalle D25/199
 1,434,242 * 10/1922 Allbright 249/32
 1,439,281 * 12/1922 Ambursen 249/31 X
 3,352,079 * 11/1967 Strong D25/199 X
 4,411,121 * 10/1983 Blacklin et al. D25/138 X
 5,107,654 * 4/1992 Leonardis D25/199 X

OTHER PUBLICATIONS
 "The Dome", p. 9, The Uni-form System, Edward W. Davis, Boston MA, 1918.*

* cited by examiner

Primary Examiner—Louis S. Zarfaz
Assistant Examiner—Robert A. Delehanty
 (74) *Attorney, Agent, or Firm—Antonelli, Terry, Stout & Kraus, LLP*

(57) **CLAIM**
 The ornamental design for a modular elements with aeration for floors, as shown.

DESCRIPTION
 FIG. 1 is a topside perspective view of a first embodiment of a modular element with aeration for floors;
 FIG. 2 is a front side elevation view thereof;
 FIG. 3 is a rear side elevation view thereof;
 FIG. 4 is a right side elevation view thereof;
 FIG. 5 is a left elevation side view thereof;
 FIG. 6 is a top plan view thereof;
 FIG. 7 is a bottom plan view thereof.
 FIG. 8 is a top side perspective view of a second of a modular element with aeration for floors;
 FIG. 9 is a front side elevation view thereof;
 FIG. 10 is a rear side elevation view thereof;
 FIG. 11 is a right side elevation view thereof;
 FIG. 12 is a left side elevation view thereof;
 FIG. 13 is a top plan view thereof; and,
 FIG. 14 is a bottom plan view thereof.

1 Claim, 14 Drawing Sheets

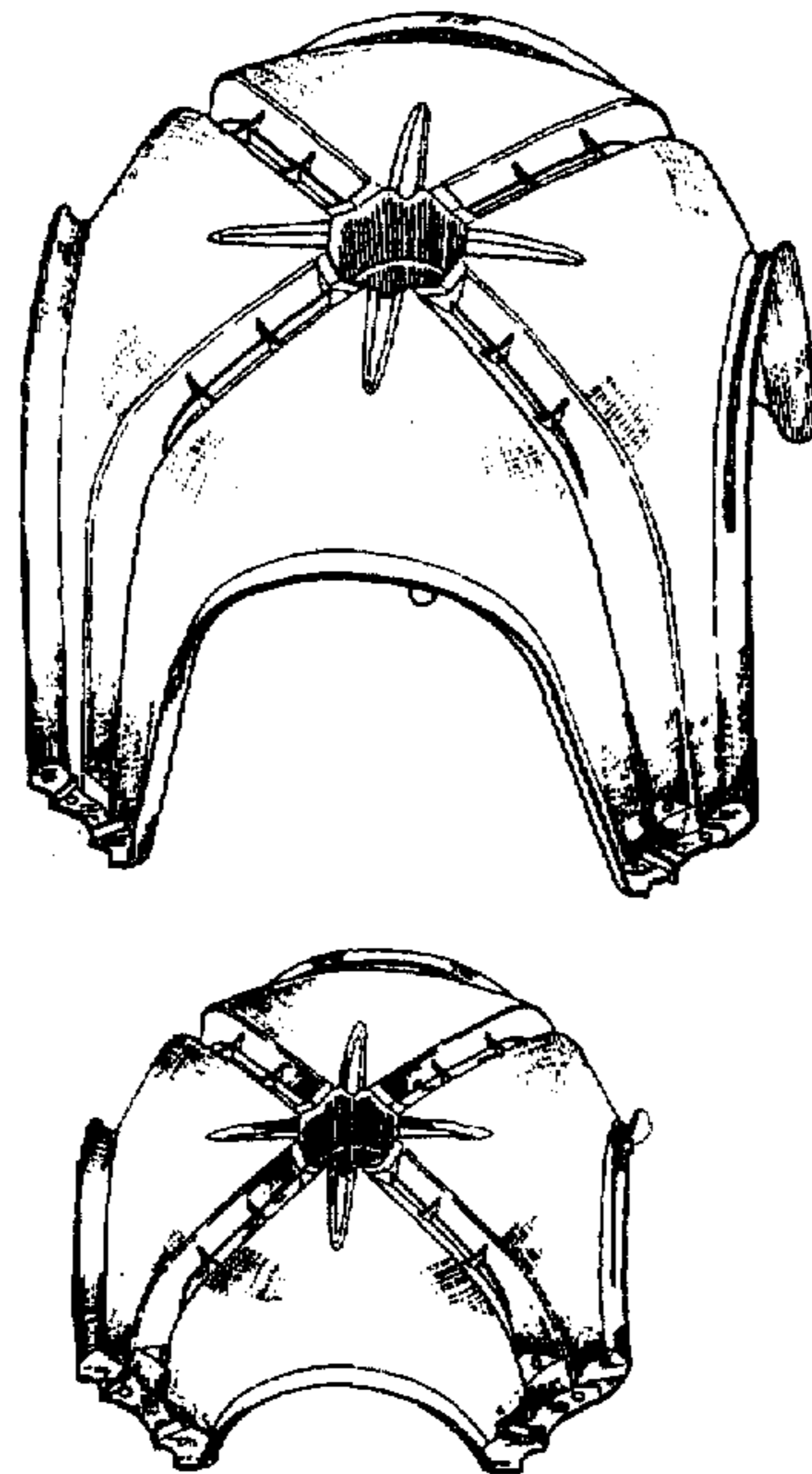
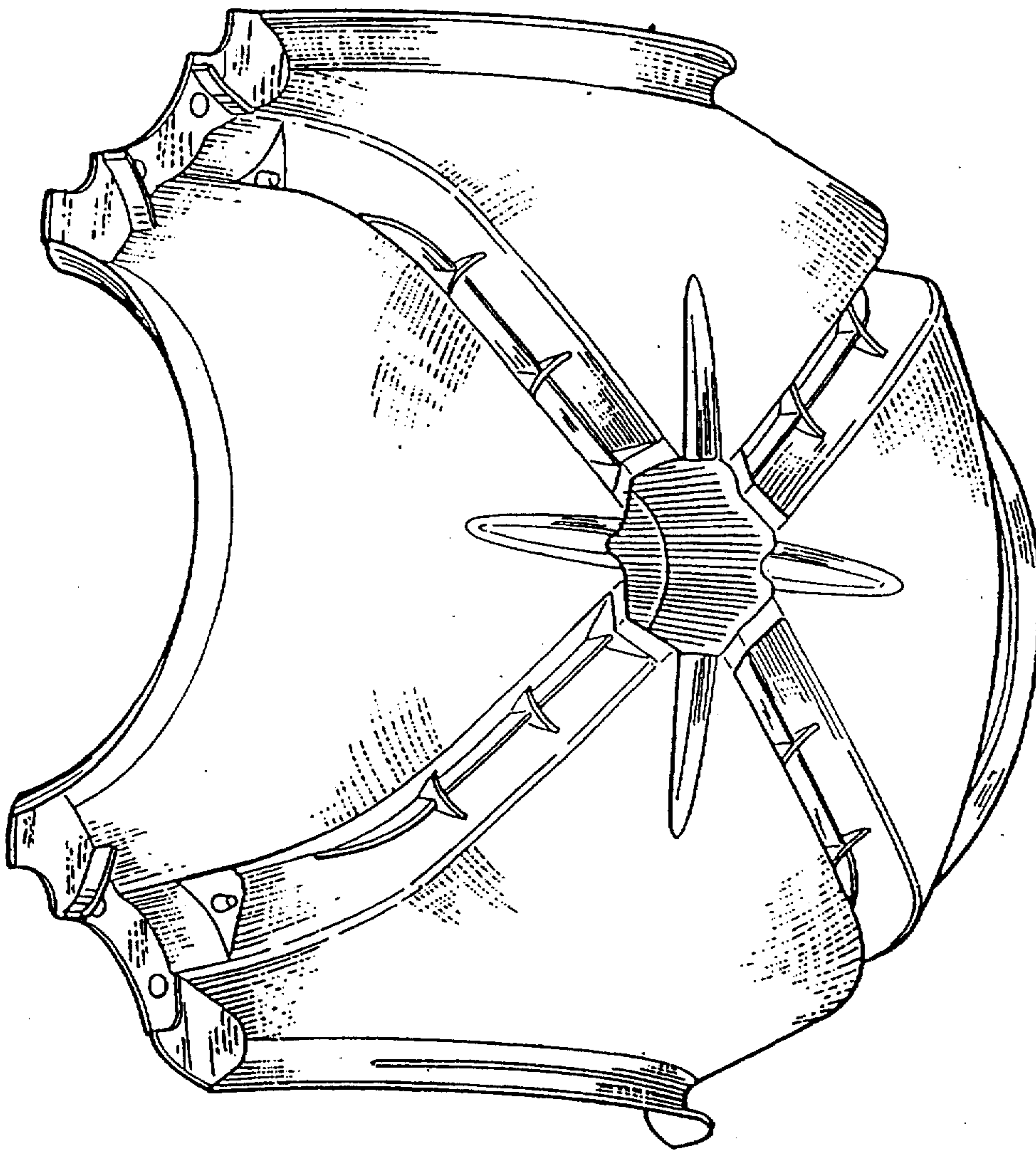

FIG. 8



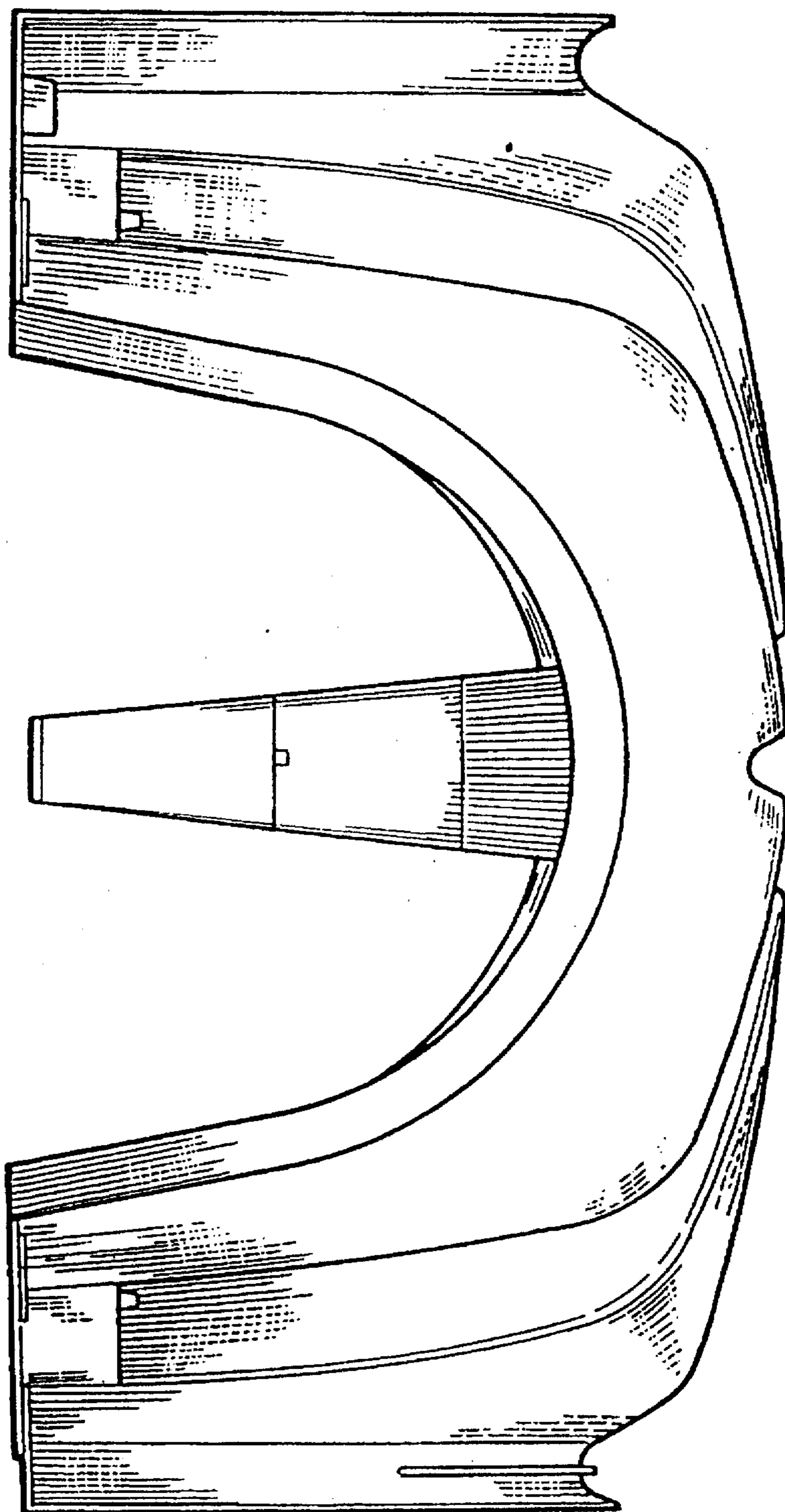

FIG. 9

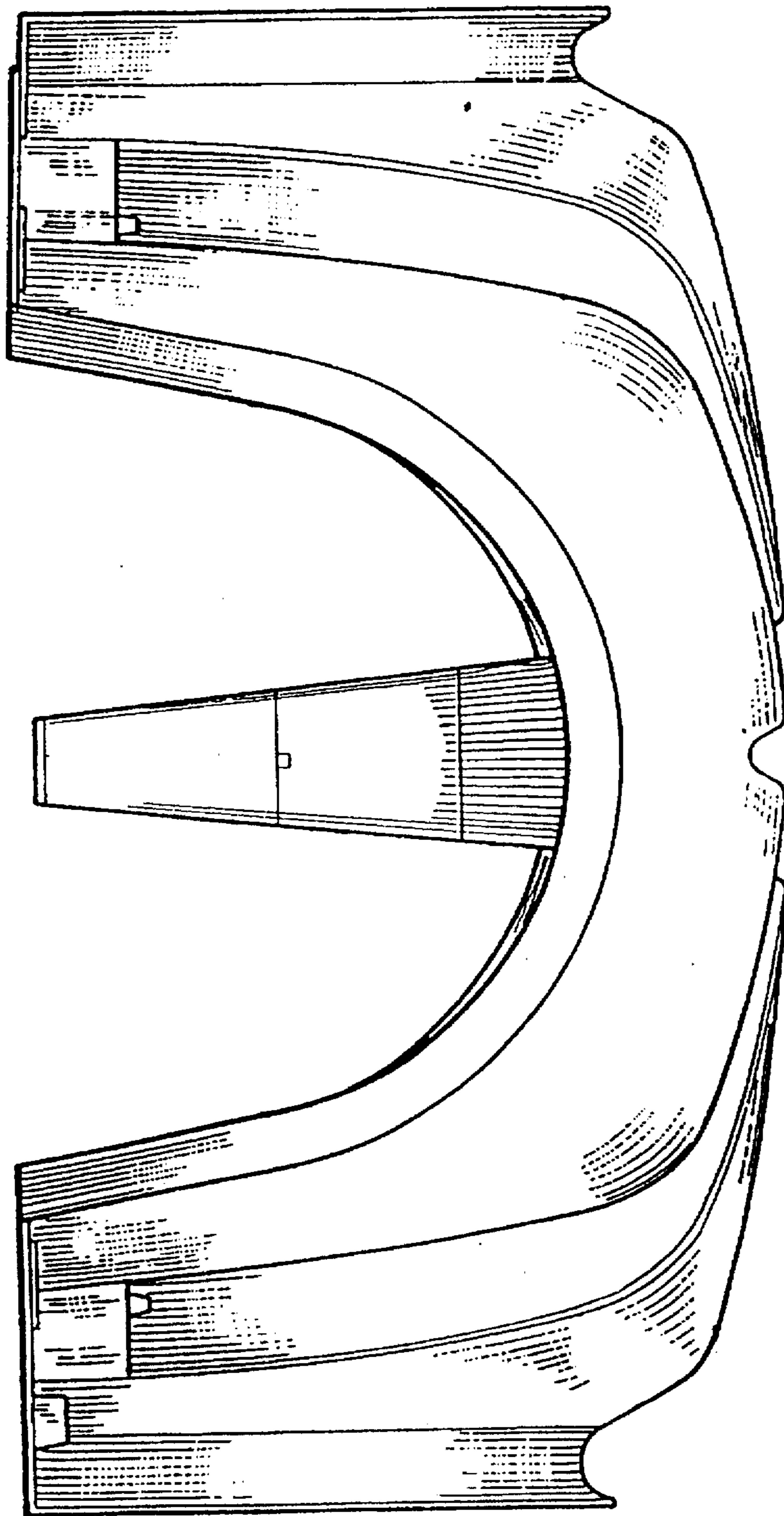

FIG. 10

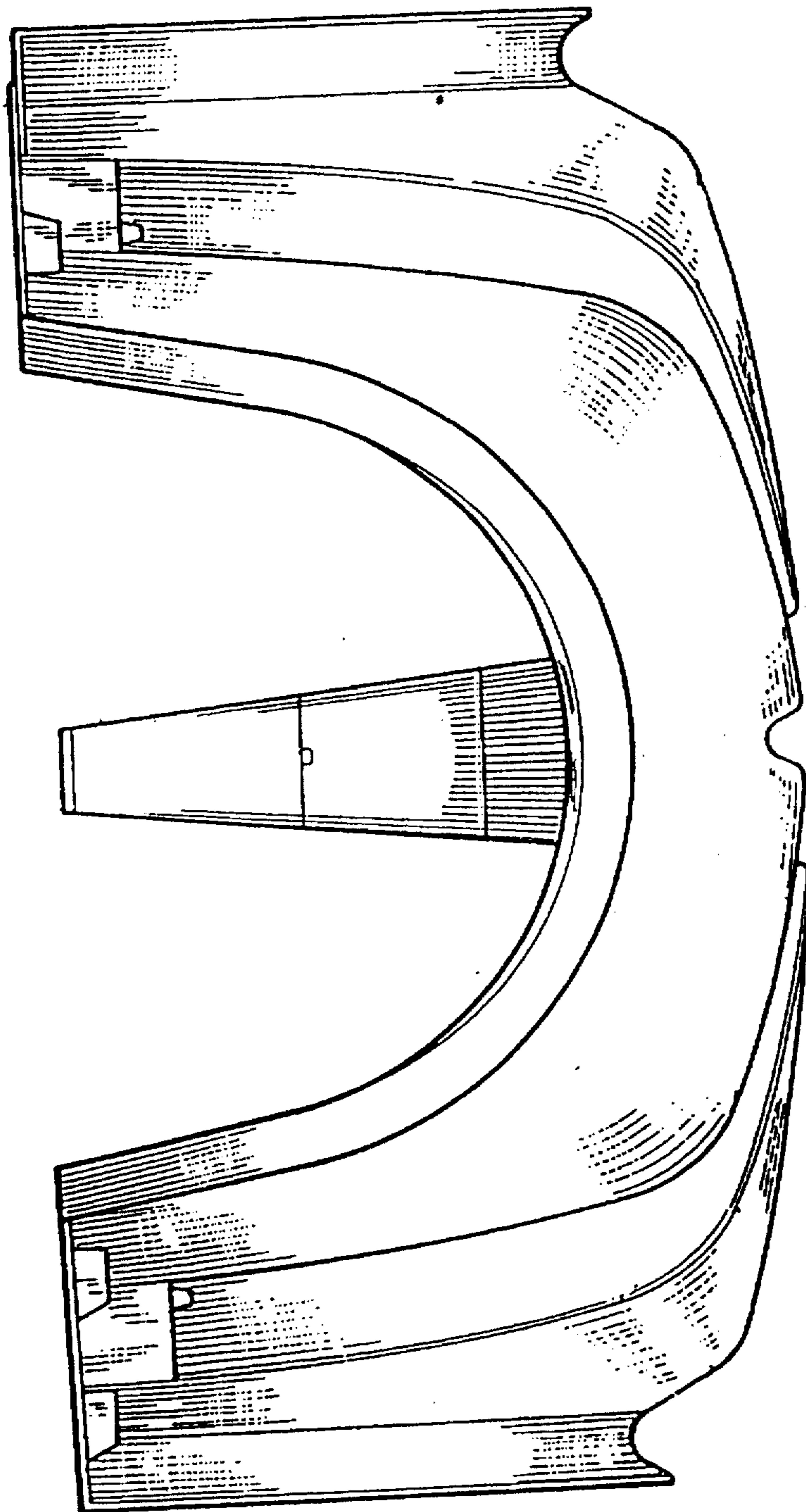

FIG. 11

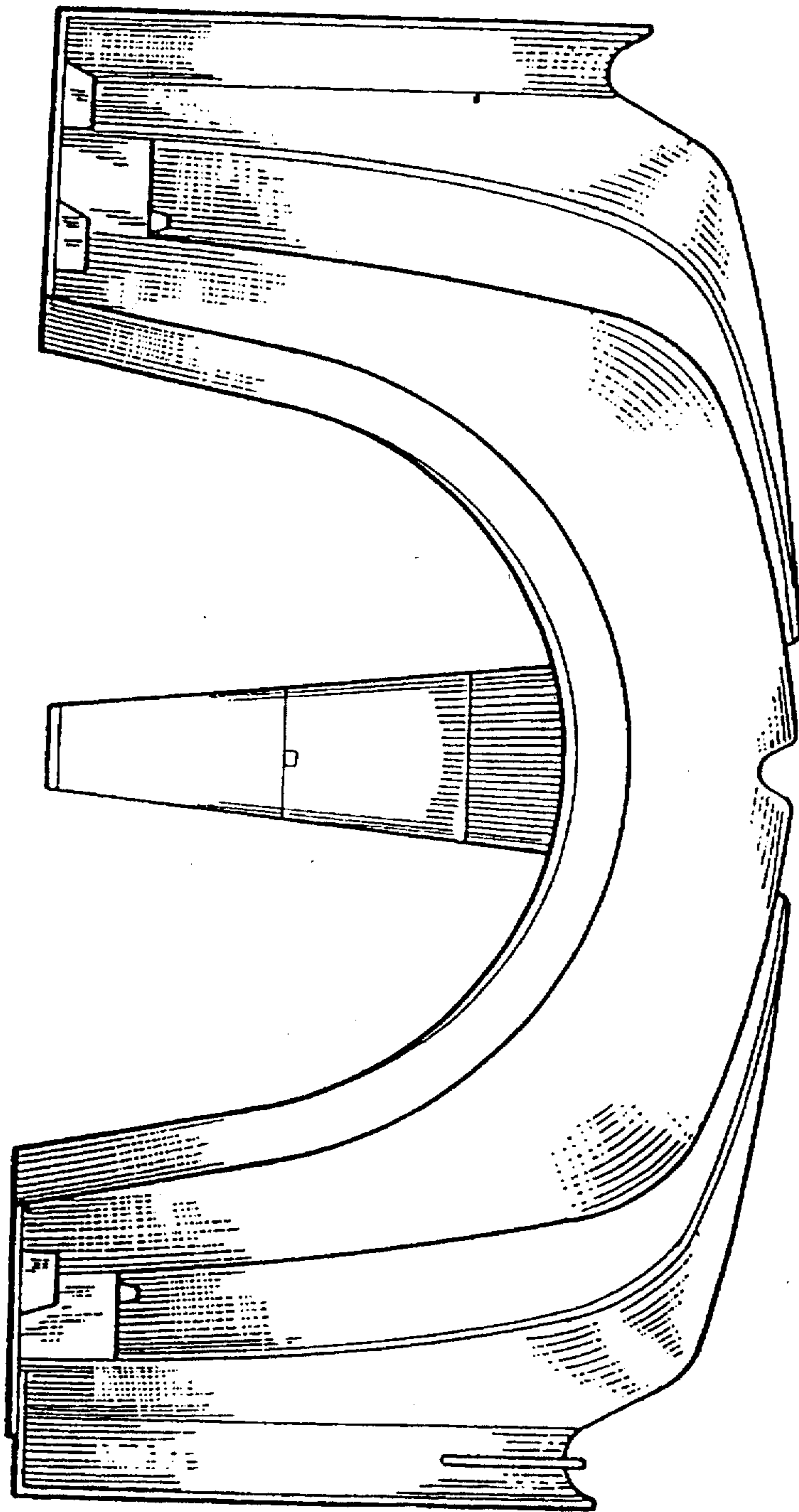

FIG. 12

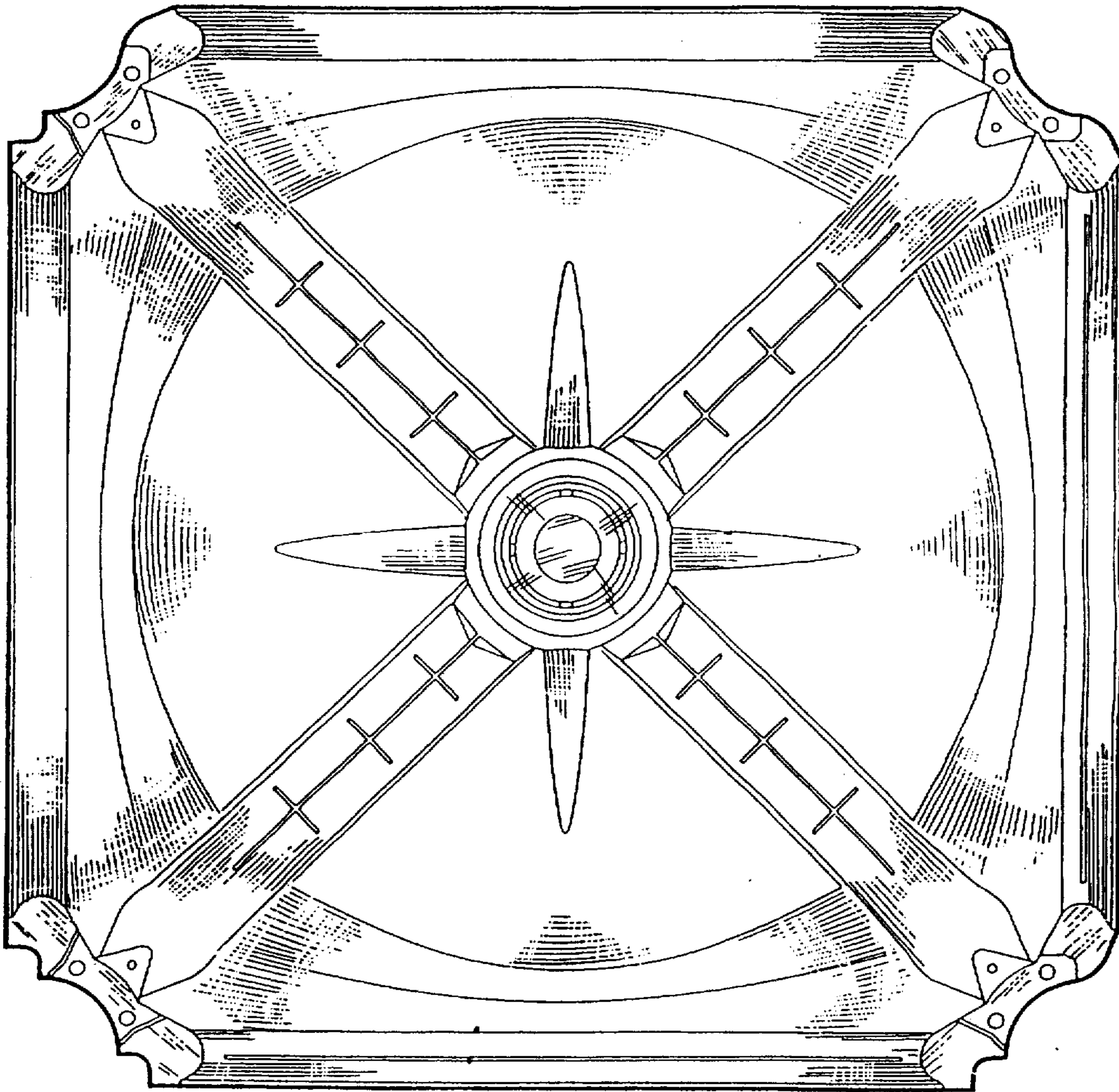

FIG. 13

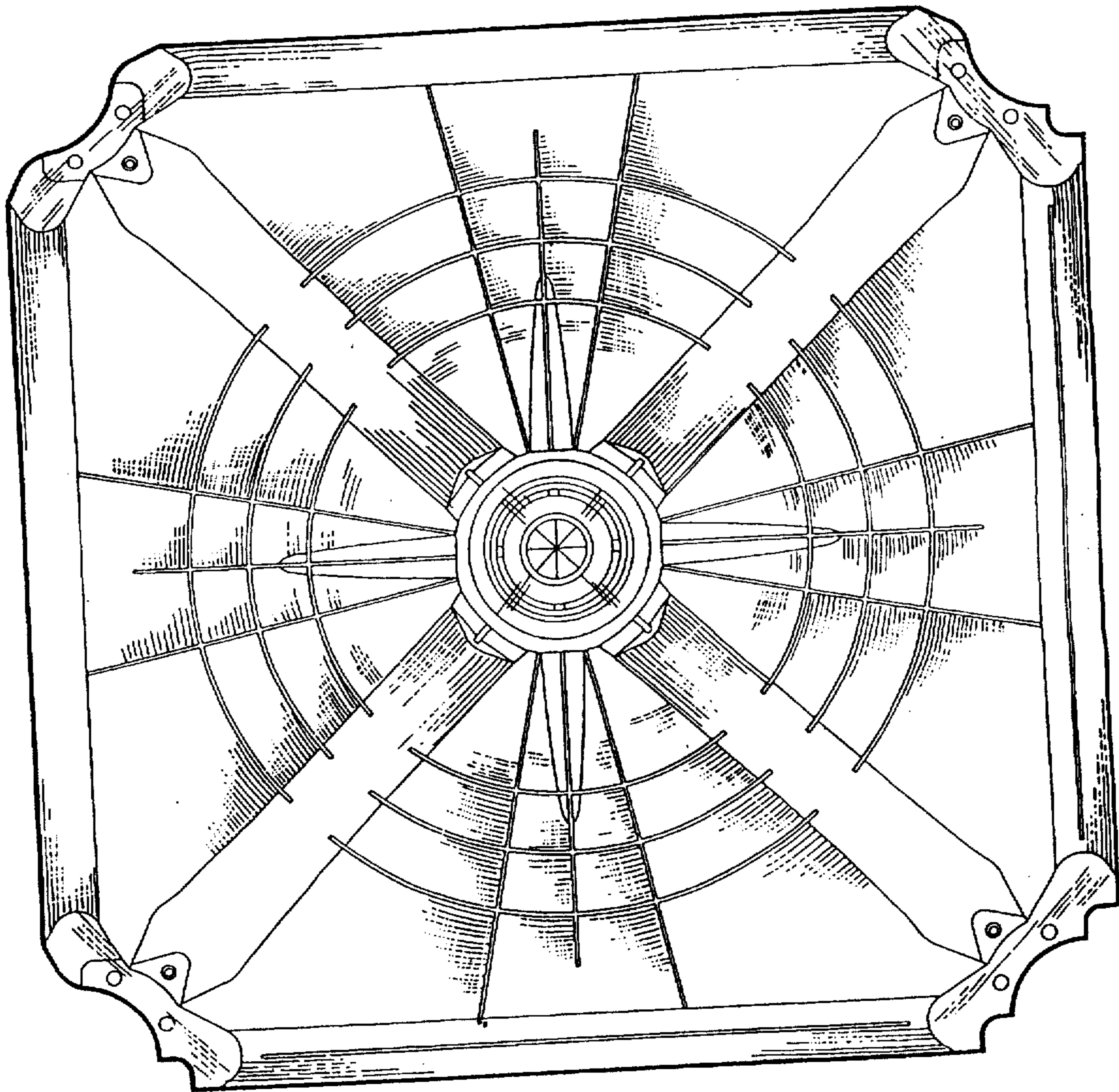

FIG. 14