



US00D451591B1

(12) **United States Design Patent**
Webb

(10) **Patent No.:** **US D451,591 S**

(45) **Date of Patent:** **** Dec. 4, 2001**

(54) **AIR VENT**

(75) **Inventor:** **Walter L. Webb, Mukilteo, WA (US)**

(73) **Assignee:** **Leen & Associates, Inc., Bellevue, WA (US)**

(**) **Term:** **14 Years**

(21) **Appl. No.:** **29/146,386**

(22) **Filed:** **Aug. 11, 2000**

Related U.S. Application Data

(62) Division of application No. 29/101,411, filed on Mar. 3, 1999, which is a continuation of application No. 09/032,413, filed on Feb. 27, 1998, now Pat. No. 5,971,847.

(51) **LOC (7) Cl.** **23-04**

(52) **U.S. Cl.** **D23/393**

(58) **Field of Search** **D23/393, 370, D23/388; 454/290, 316, 325**

(56) **References Cited**

U.S. PATENT DOCUMENTS

D. 358,205 * 5/1995 Ruhland D23/393

* cited by examiner

Primary Examiner—Lisa Lichtenstein

(74) *Attorney, Agent, or Firm*—Dean A. Craine

(57) **CLAIM**

The ornamental design for an air vent, as shown and described.

DESCRIPTION

FIG. 1 is a perspective view of the subject design air vent.

FIG. 2 is a top plan view of the invention.

FIG. 3 is a bottom plan view of the invention.

FIG. 4 is a front elevation view of the invention.

FIG. 5 is a rear elevation view of the invention.

FIG. 6 is a left side elevation view of the invention; and,

FIG. 7 is a right side elevation view of the invention.

1 Claim, 3 Drawing Sheets

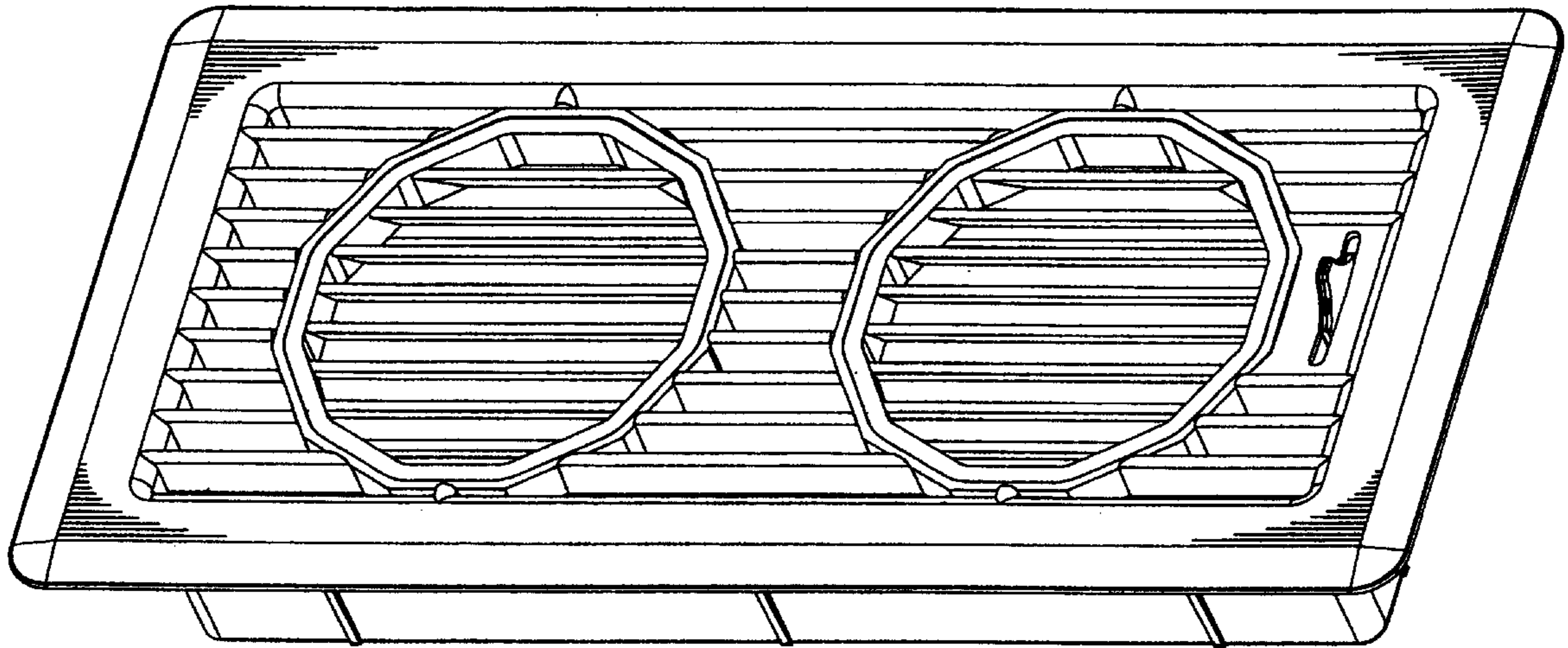

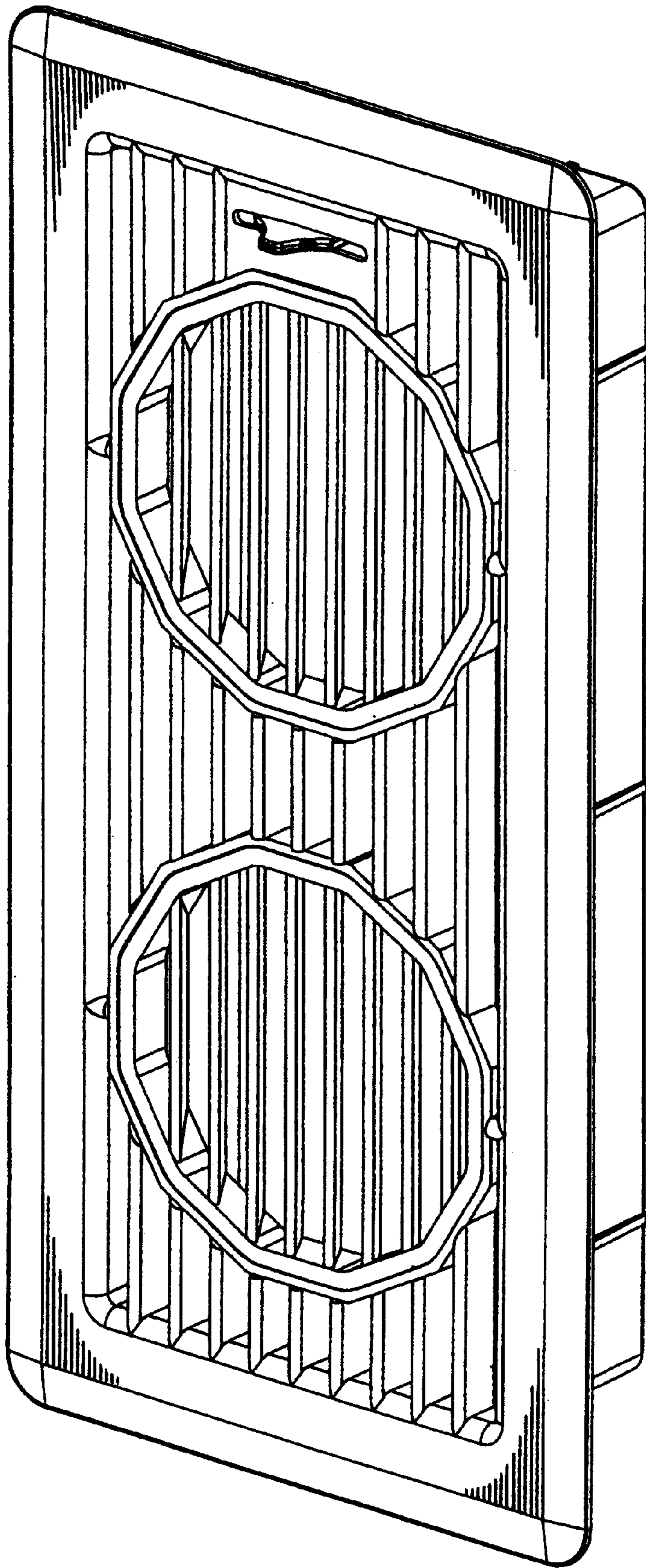

Fig. 1.

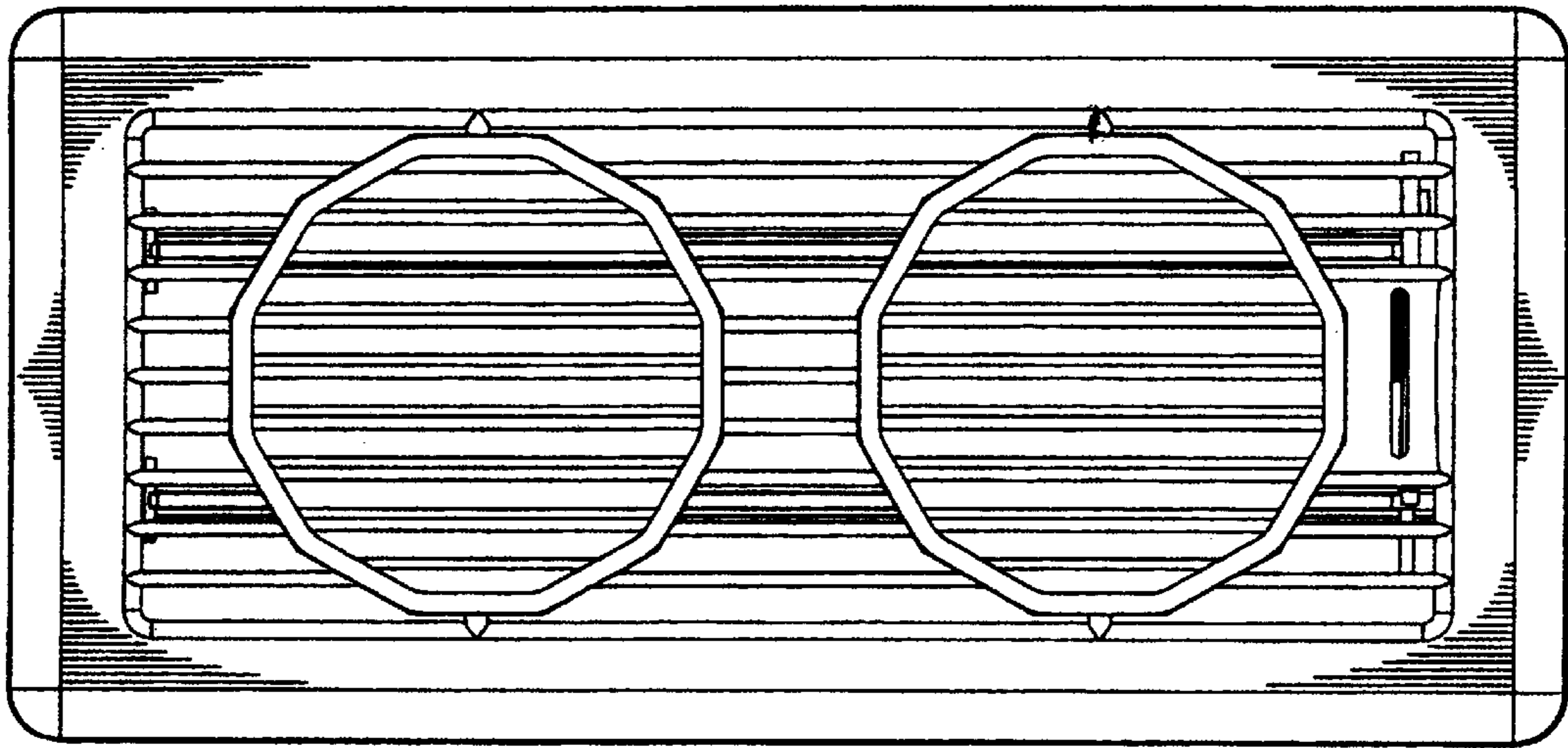

Fig. 2.

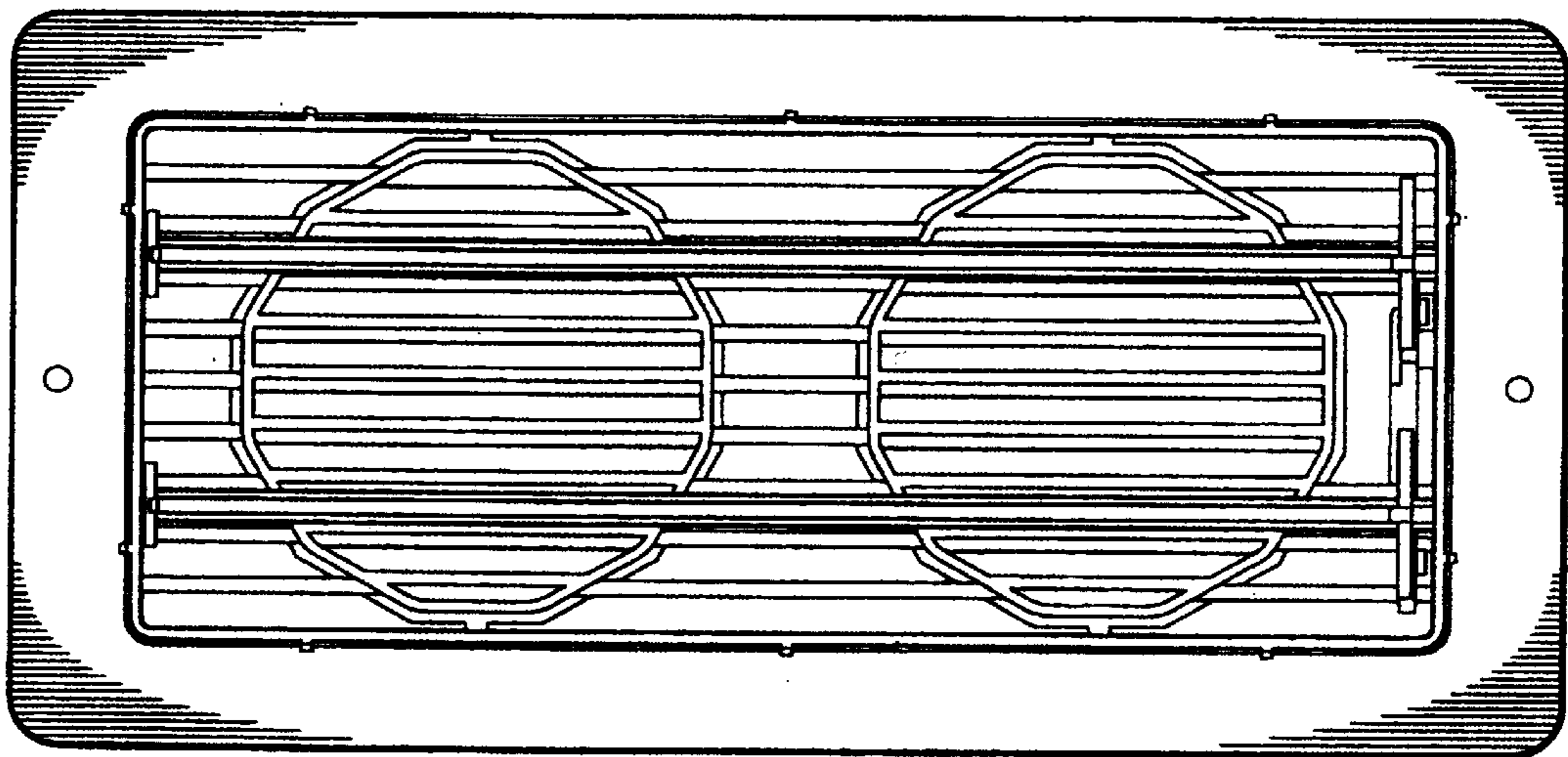

Fig. 3.

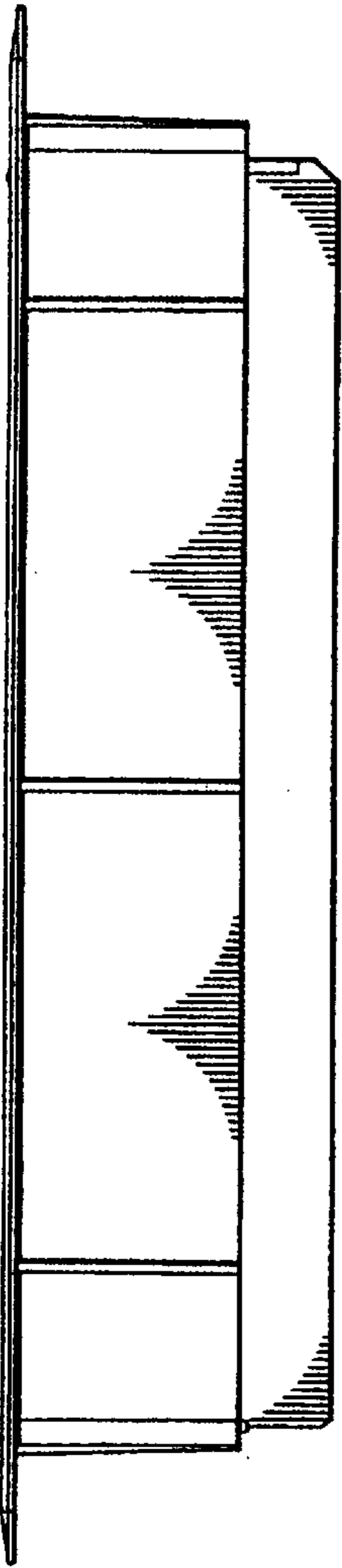

Fig. 4.

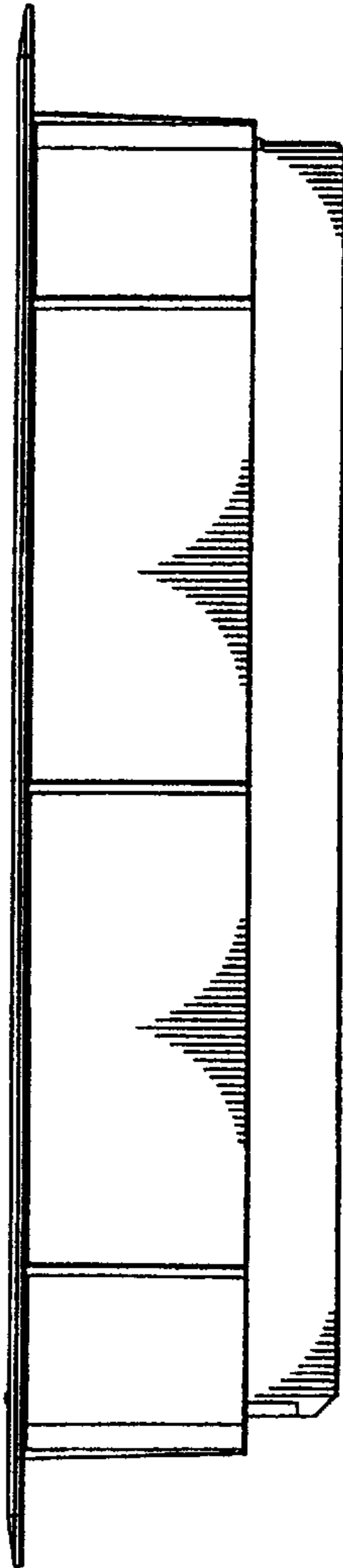

Fig. 5.

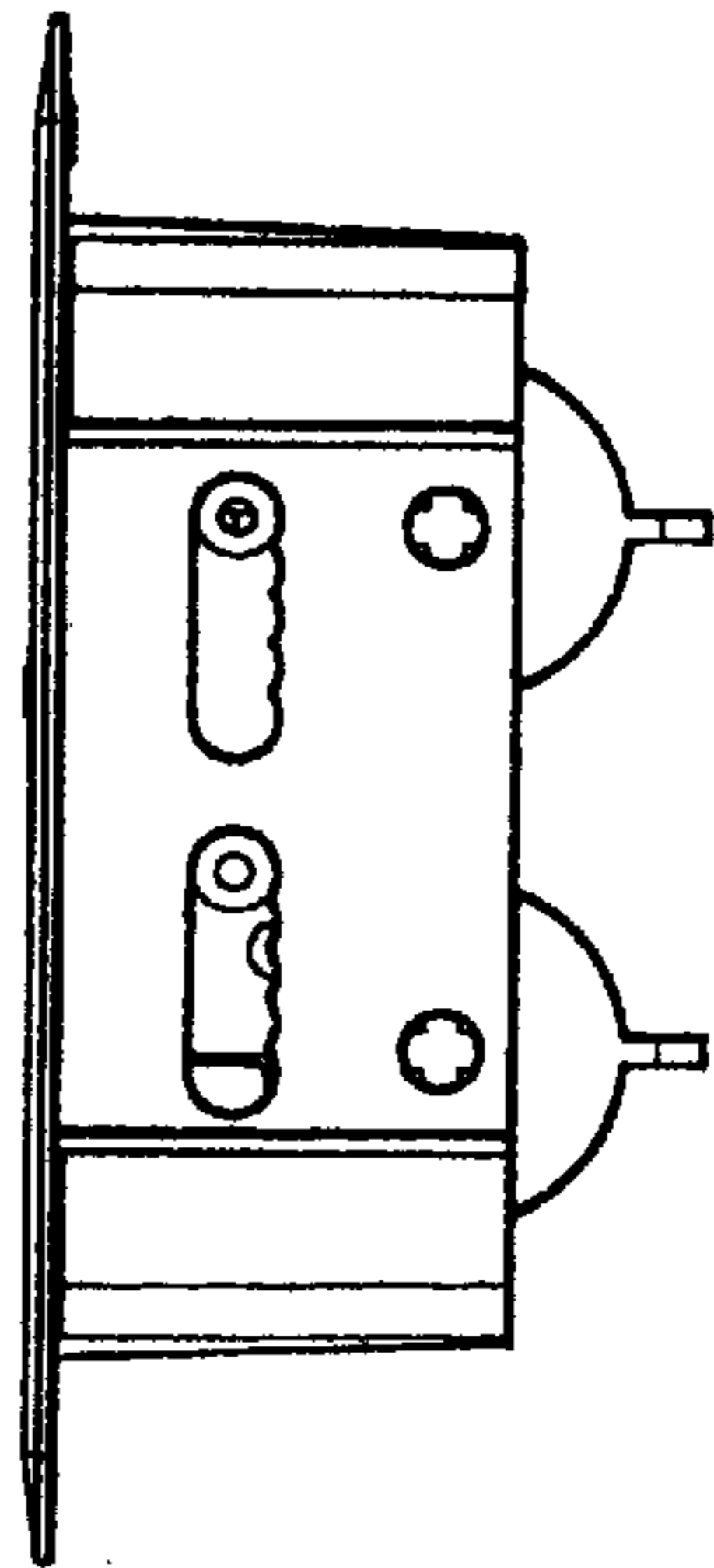

Fig. 6.

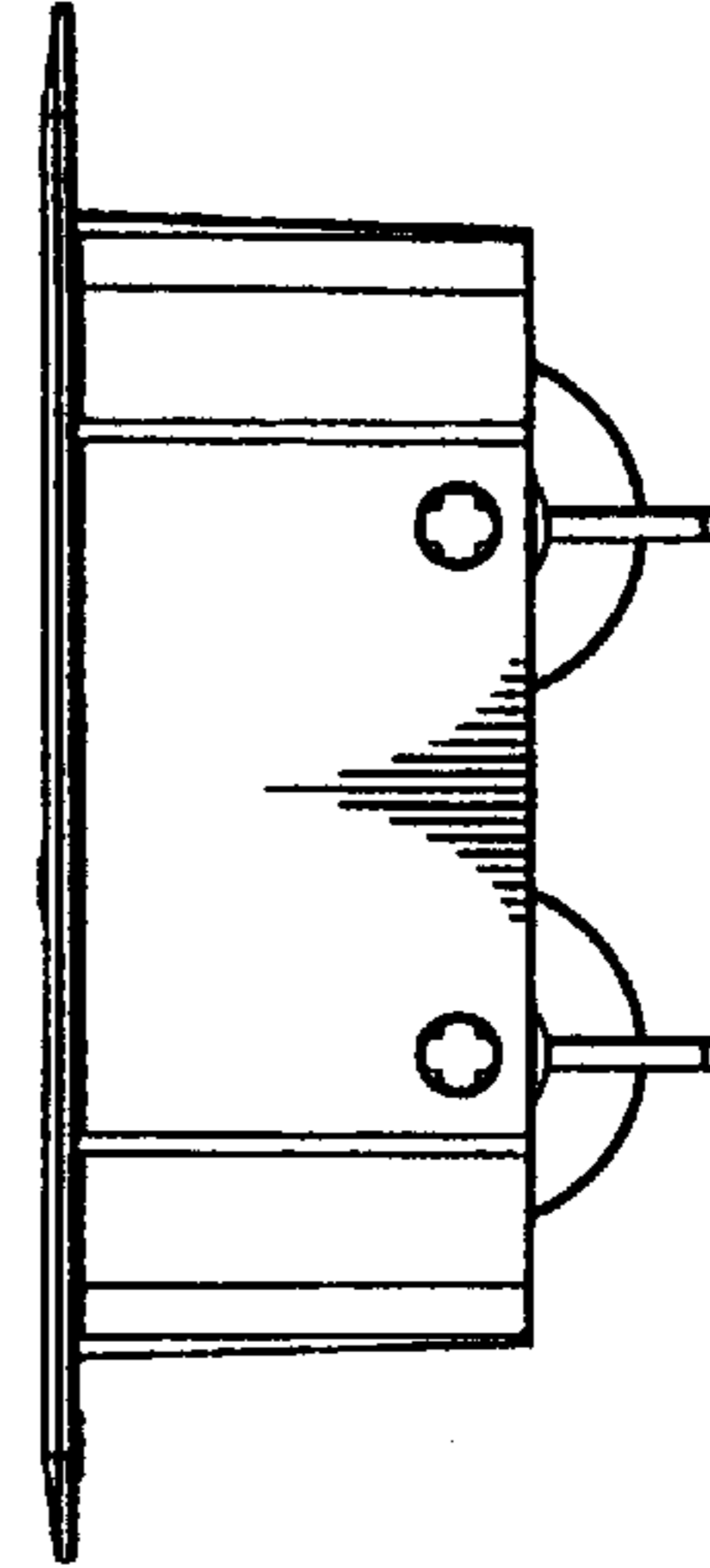

Fig. 7.